

HMS
ENDEAVOUR



STEP-BY-STEP INSTRUCTIONS
INTRUCCIONES PASO A PASO
NOTICE DE MONTAGE PAS-À-PAS
SCHRITT FÜR SCHRITT ANWEISUNGEN
STAP VOOR STAP INSTRUCTIES
ISTRUZIONI PASSO PER PASSO
ПОШАГОВАЯ ИНСТРУКЦИЯ





HOBBY KNIFE N°1
Cuchilla · Cutter
ref. 27019

+ INFO



SET OF 4 MINI PLIERS (90mm)
Minisargentos · Mini Serre Joints
ref. 27201

+ INFO



TWEEZERS
Pinzas · Pincas
ref. 27020

+ INFO

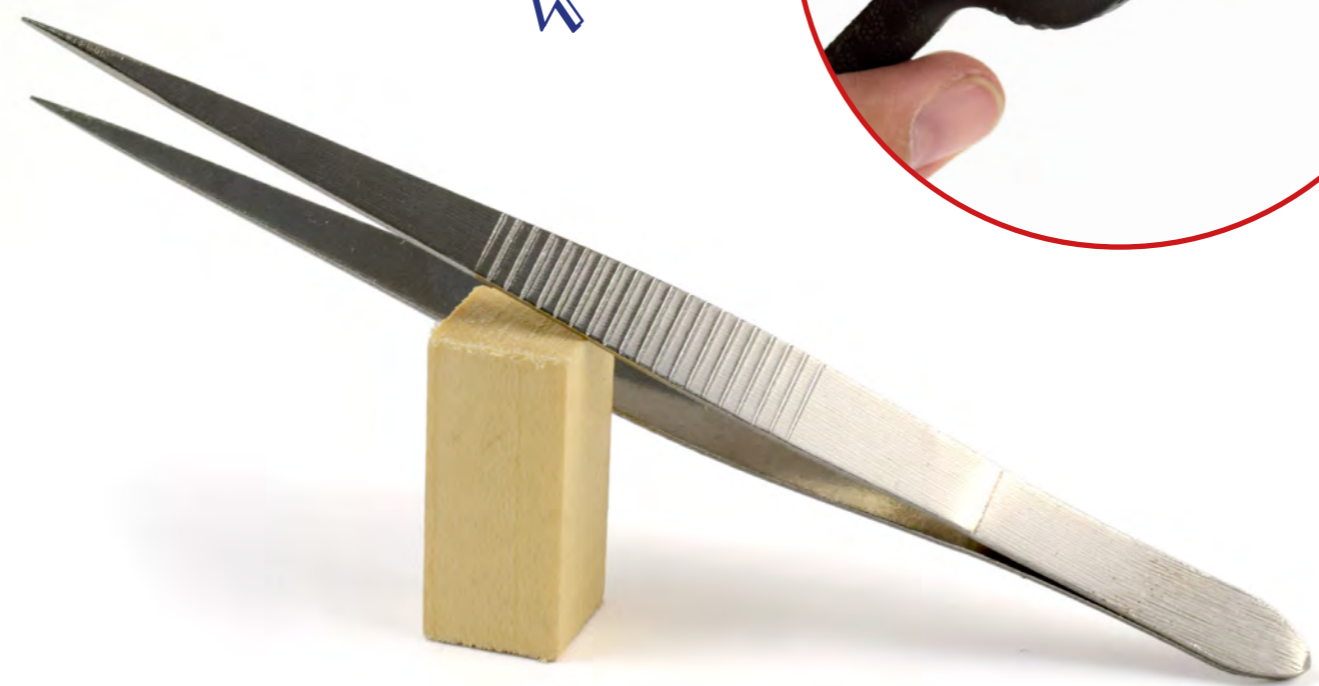

MINI DIAMOND FILES SET (100mm)

Mini-limas diamante · Mini-limes diamant

ref. 27015-3

+ INFO

NEW!



FILES

Limas · Limes

ref. 27015-1

+ INFO



SANDING BLOCK

Taco lijador · Ponceur en boi

ref. 27014

+ INFO



HAND DRILL + HSS DRILL BITS

Taladro manual + brocas HSS · Outil à percer à main + forets HSS

ref. 27018-1

+ INFO



LIQUID FOR BRASSBLUING

Solución para pavonar latón · liquide pour le bleuissement du laton

ref. 27795

NEW!



MICRO SAW SET

Micro herramientas · Micro outils

ref. 27302

+ INFO



ELECTRIC PLANK BENDER

Plegalstones eléctrico · Fer à cintrer électrique

ref. 27074-1

+ INFO

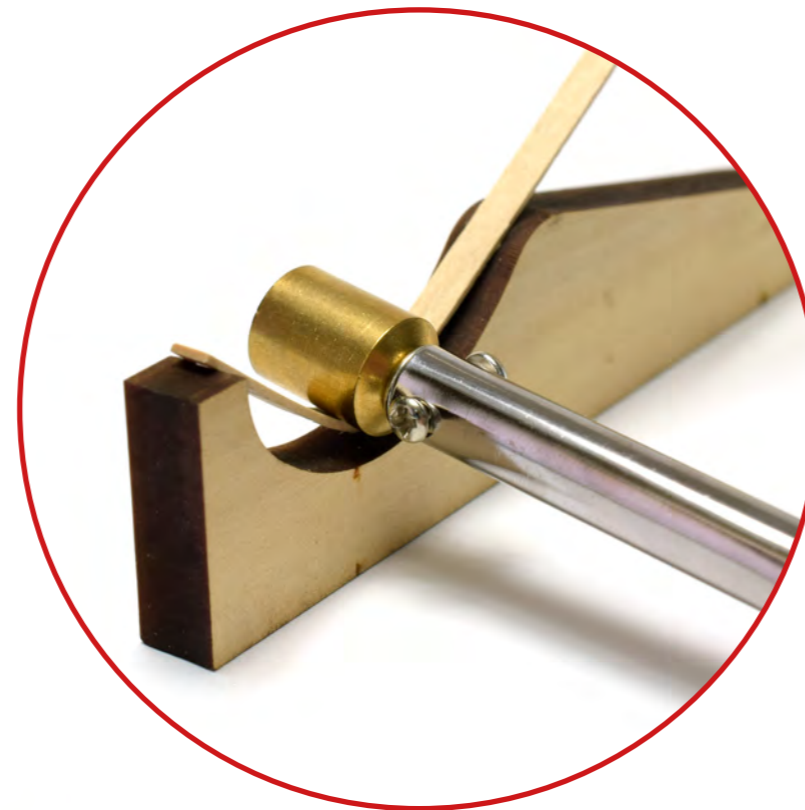

NEW!

MICRO RIGGING TOOLS

Herramienta para micro aparejo · Outil de micro gréement

ref. 27321



MICRO DRAWING SET

Micro herramienta · Micro outil

ref. 27325

+ INFO

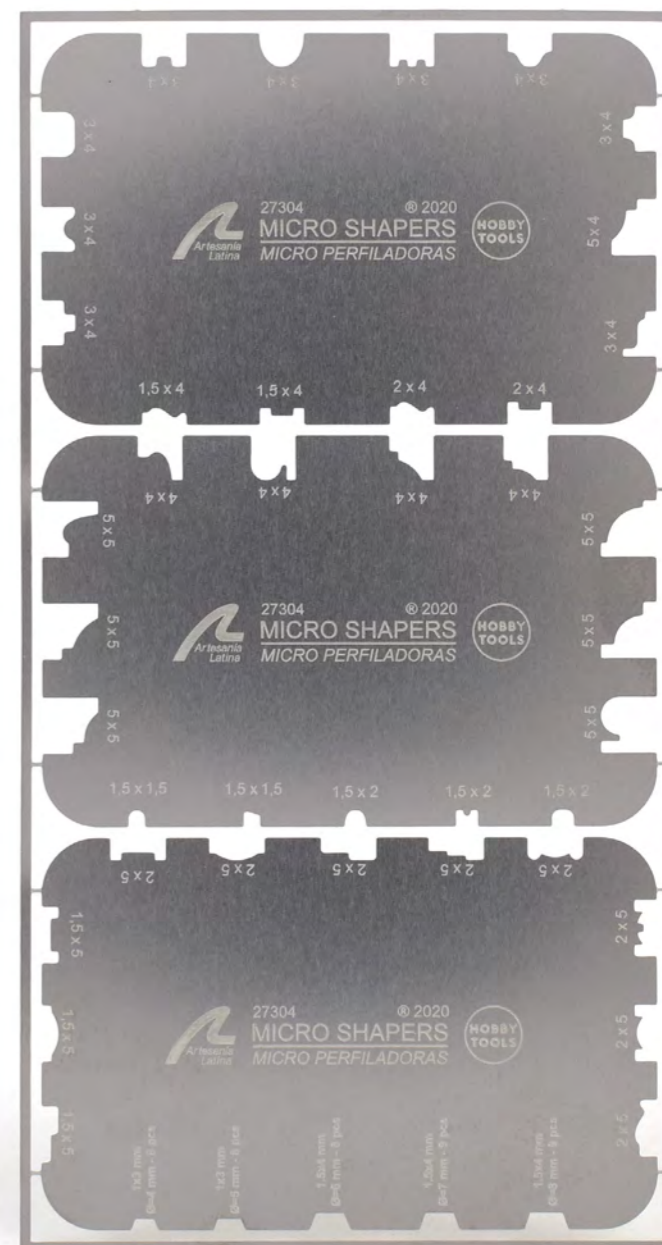

MICROSHAPERS

Micro perfiladoras ·
Micro Profileuses

ref. 27300 - 27301 - 27304

NEW!

+ INFO



QUIZÁS TE PUEDE INTERESAR...
MAYBE, YOU HAVE INTERESTED IN...
VOUS POURRIEZ ÊTRE INTÉRESSÉ...

METAL FIGURINES SET

Set de figuras de metal · Set du
figurines en métal

ref. 22520F

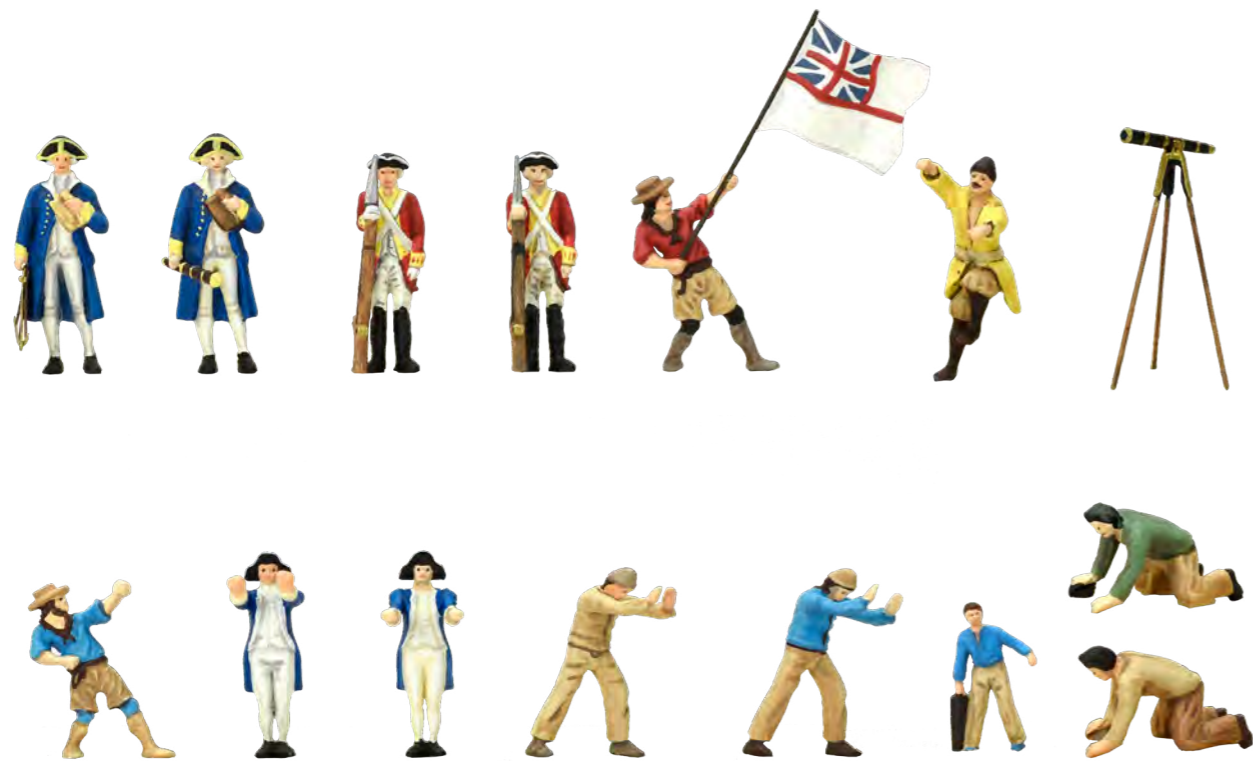

LIGHTING SET

Set de luces · Set de lumières

ref. 27590



**PRÓXIMAMENTE
COMING SOON
PROCHAINEMENT**

HMS ENDEAVOUR'S CAPTAIN LONGBOAT

Lancha del capitán HMS Endeavour · Canot du Capitaine
du HMS Endeavour

ref. 19005





ENCAJAR
FIT TOGETHER
ASSEMBLER
PASSEN
PASSEN
METTERE INSIEME
ПРИГОДНЫЙ



REPETIR
REPEAT
REPÉTER
WIEDERHOLEN
HERHALEN
RIPETERE
ПОВТОРЕНИЕ



REPETIR SIMÉTRICAMENTE
REPEAT SYMMETRICALLY
RÉPÉTER SYMÉTRIQUEMENT
SYMMETRISCH WIEDERHOLEN
HERHAAL SYMMETISCH
RIPETERE SIMMETRICAMENTE
ПОВТОРНЫЙ СИММЕТРИЧЕСКИЙ



ROTAR
TURN
TOURNER
DREHEN
DRAAIEN
GIRARE
ПРЕВРАТИТЬ



SUJETAR CON CINTA ADHESIVA
HOLD WITH ADHESIVE TAPE
FIXER A L'AIDE DE RUBAN ADHESIF
MIT KLEBEBAND BEFESTIGEN
MET PLAKBAND VASTZETTEN
FISSARE CON NASTRO ADESIVO
ИСПРАВИТЬ С ПОМОЩЬЮ КЛЕЙКОЙ ЛЕНТЫ



CORTAR
CUT
COUPER
SCHNITT
SNIJDEN
TAGLIARE
ПОРЕЗ



TALADRAR
DRILL
PERCER
BOHREN
BOREN
TRAPANARE
ДРЕЛЬ



LIJAR
SAND
PONCERSAND
ZAND
SCARTAVETRARE
ПЕСОК



DAR FORMA CÓNICA
GIVE TAPER
DONNER UNE FORME CONIQUE
GIB TAPER
GEEF HET EEN KEGELVORM
DARE FORMA CONICA
ЗАУЗИТЬ



DEENMASCARAR
UNMASK
DÉMASQUER
ENTLARVEN
ONTMASKEREN
SMASCHERARE
РАЗОБЛАЧАТЬ



PEGAR
GLUE
COLLER
KLEBEN
LIJM
INCOLLARE
КЛЕЙ



NO PEGAR
DO NOT GLUE
EN PAS COLLER
NICHT KLEBEN
NIET LIJMEN
NON INCOLLARE
НЕ КЛЕЙ



DOBLAR
BEND
PLIER
BIEGE
VOUWEN
PIEGARE
СОГНИТЕ



DAR FORMA CÓNICA X2
GIVE TAPER X2
DONNER UNE FORME CONIQUE X2
GIB TAPER X2
GEEF HET EEN KEGELVORM X2
DARE FORMA CONICA X2
ЗАУЗИТЬ X2



ENMASCARAR
MASK
MASQUER
MASKE
MASKER
MASCHERA
MASKA



ENMASILLAR
APPLY PUTTY
CALFEUTRER
PUTTY ANLEGEN
VULMIDDEL AANBRENGEN
APPLICARE LO STUCCO
ЗАЯВКА



MARCAR A LÁPIZ
MARK WITH A PENCIL
MARQUER AU CRAYON
MARK MIT EINEM BLEISTIFT
MARKEREN MET EEN POTLOOD
SEGNARE CON UNA MATITA
МАРК С КАРАНДАРОЙ



MEDIR
MEASURE
MESURE
MESSEN
MAATREGEL
MISURARE
ИЗМЕРЕНИЕ



INICIO DEL CABLE
CABLE START
DÉMARRAGE DU CÂBLE
KABELSTART
KABEL START
AVVIAMENTO CON CAVO
КАБЕЛЬНЫЙ СТАРТ

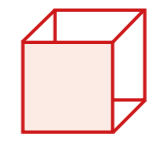

VISTA FRONTAL
FRONT VIEW
VUE DE FACE
VORDERANSICHT
VOORAANZICHT
VISTA FRONTALE
ВИД СПЕРЕДИ



ALINEAR
ALIGN
ALIGNER
AUSRICHTEN
UITLIJNEN
ALLINEARE
ВЫРОВНЯТЬ



COLOCAR EN PUNTO MEDIO
PLACE IN THE CENTER
PLACER AU MILIEU
IN DER MITTE PLATZIEREN
PLAATS IN HET MIDDEN
POSIZIONARE AL CENTRO
РАЗМЕСТИТЕ В ЦЕНТРЕ



TENSAR HILO LIGERAMENTE
STRETCH THREAD SLIGHTLY
TENDRE LEGEREMENT LE FIL
STRETCH GEWINDE LEICHT
DRAAD LICHT SPANNEN
TENDERE IN FILO LEGGERMENTE
СЛЕГКА РАСПРЯМИТЬ НИТЬ



FIN DEL CABLE
CABLE END
FIN DE CABLE
KABELLENDE
EINDE VAN DE KABEL
FINE DEL CAVO
КОНЕЦ КАБЕЛЯ

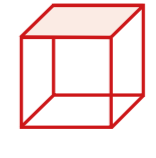

VISTA SUPERIOR
TOP VIEW
VUE DE DESSUS
DRAUFSICHT
BOVENAANZICHT
VISTA DALL'ALTO
ВИД СВЕРХУ



BARNIZAR
VARNISH
VERNIR
LACK
LAKKEN
VERNICIARE
ЛАК



TEÑIR
DYE
TEINDRE
FÄRBN
VERVEN
TINGERE
КРАСИТЬ



ANUDAR
KNOT
FAIRE UN NOEUD
KNOTEN
MAAK EEN KNOOP
FARE UN NODO
МОРСКОЙ УЗЕЛ



VER VIDEO
WATCH VIDEO
VOIR VIDÉO
SCHAU VIDEO
BEKIJK VIDEO
GUARDA UN VIDEO
СМОТРЕТЬ ВИДЕО

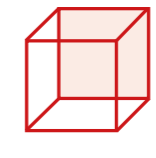

VISTA TRASERA
BACK VIEW
VUE ARRIERE
RÜCKANSICHT
ACHTERAANZICHT
VISTA POSTERIORE
ВИД СЗАДИ



PINTAR
PAINT
PEINDRE
FARBE
SCHILDEREN
DIPINGERE
ПОКРАСИТЬ



IMPRIMAR
APPLY PRIMER
APPLIQUER L'APPRÊT
PRIMER AUFTRAGEN
BRENG PRIMER AAN
APPLICARE IL PRIMER
НАНЕСТИ ГРУНТОВКУ



CLAVAR
NAIL
CLOUER
EINSCHLAGEN
SPIJKER
INCHIODARE
ЗАБЕЙТЕ ГВОЗДЬ



SOLDAR
WELD
SOUDER
SCHWEISSEN
LASSEN
SALDARE
СВАРКА

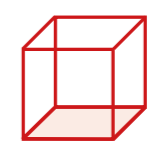

VISTA INFERIOR
BOTTOM VIEW
VUE DE DESSOUS
UNTERSICHT
ONDERAANZICHT
VISTA DAL BASSO
ВИД СНИЗУ

COLOR REF.

- 1

BLANCO ROTO
OFF WHITE
27702
- 2

AZUL REAL
ROYAL BLUE
27720
- 3

ROJO VIVO
BRIGHT RED
27710
- 4

SOMBRA TOSTADA
BURNT UMBER
27743
- 5

AMARILLO INTENSO
DEEP YELLOW
27731
- 6

NEGRO ROTO
OFF BLACK
27703
- 7

CACAO
COCOA BROWN
27741
- 8

AMARILLO CAQUI
BUFF
27740
- 9

ORO
GOLD
27761
- 10

BARNIZ SATINADO TRANSPARENTE
SEMI-GLOSS CLEAR VARNISH
27605
- 11

BARNIZ SATINADO ROBLE
SEMI GLOSS OAK SHADE
VARNISH
27606
- 12

TINTE SAPELLI
DYE FOR WOOD SAPELE
27690

NEW!



01

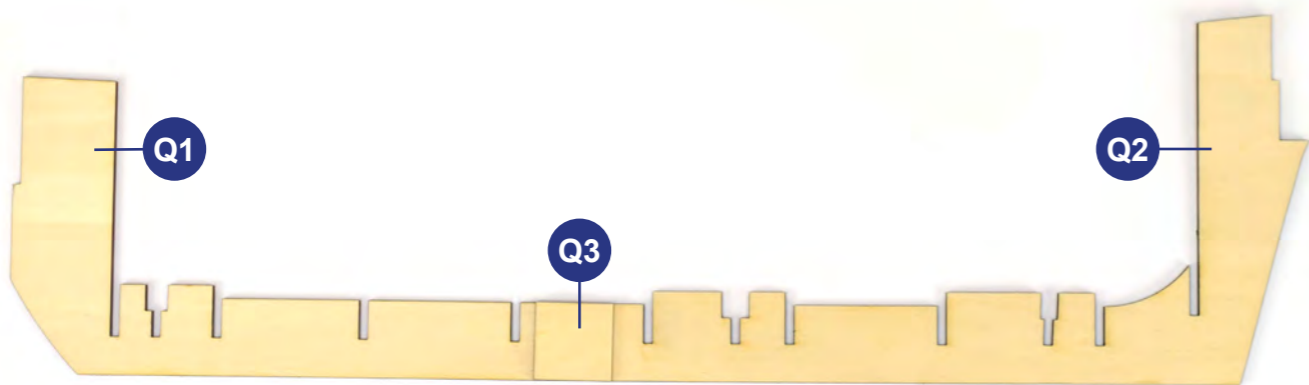
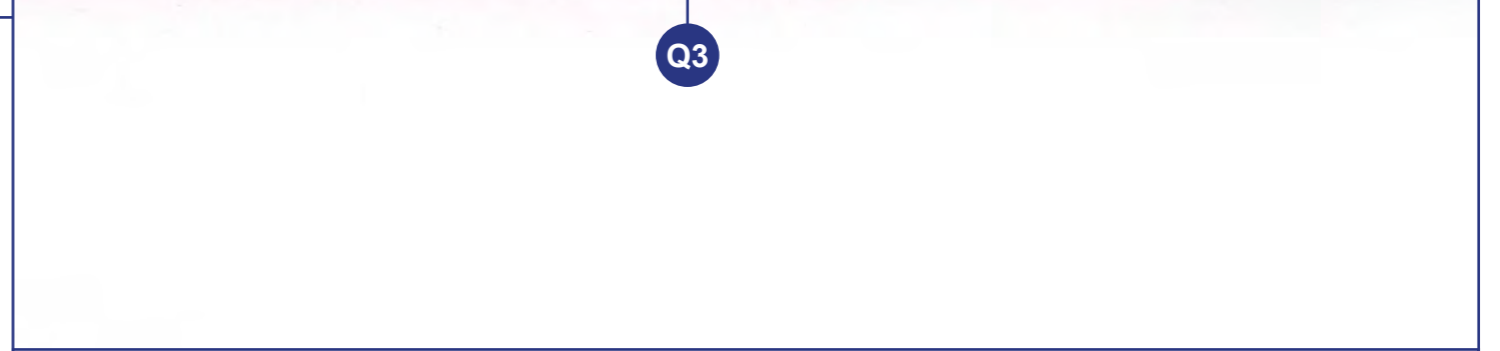
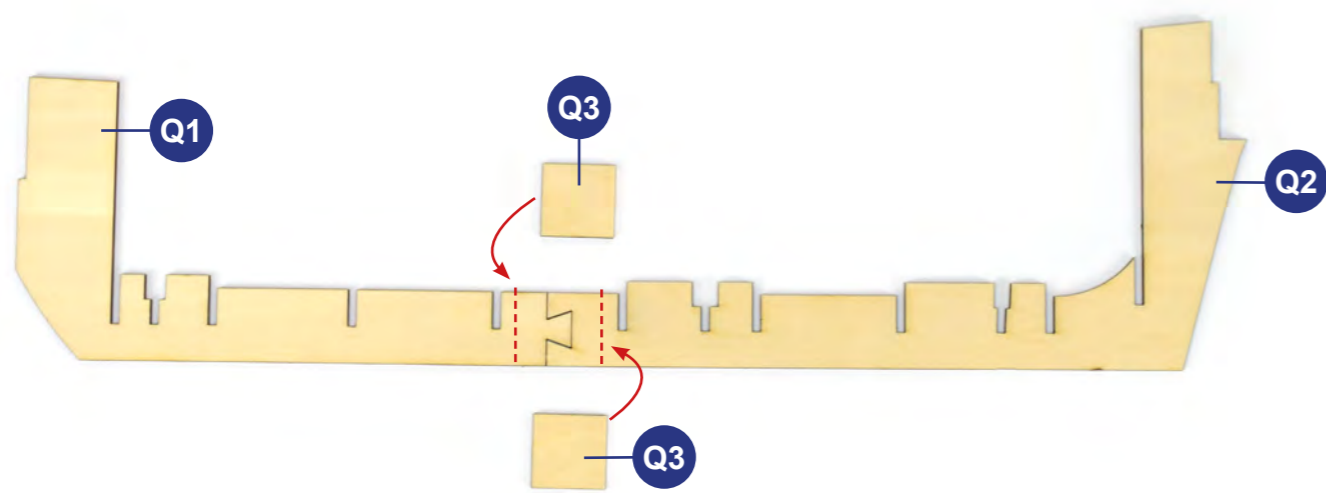
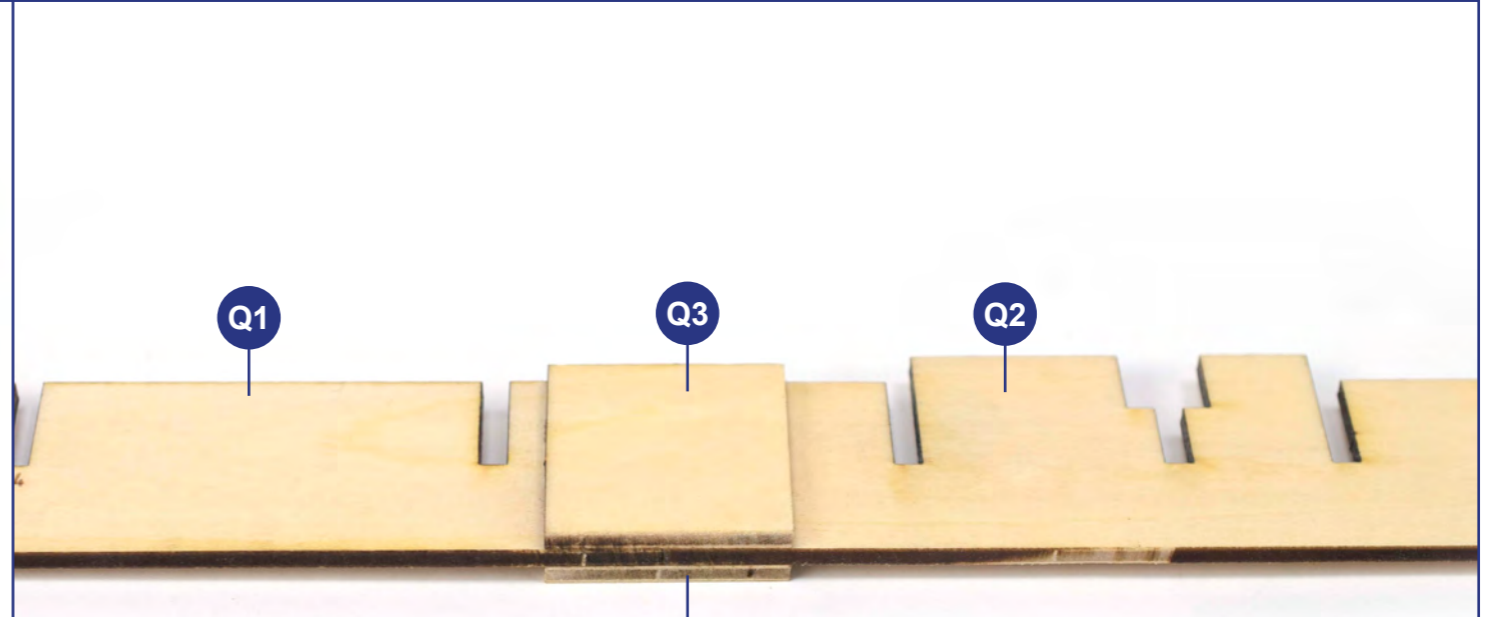
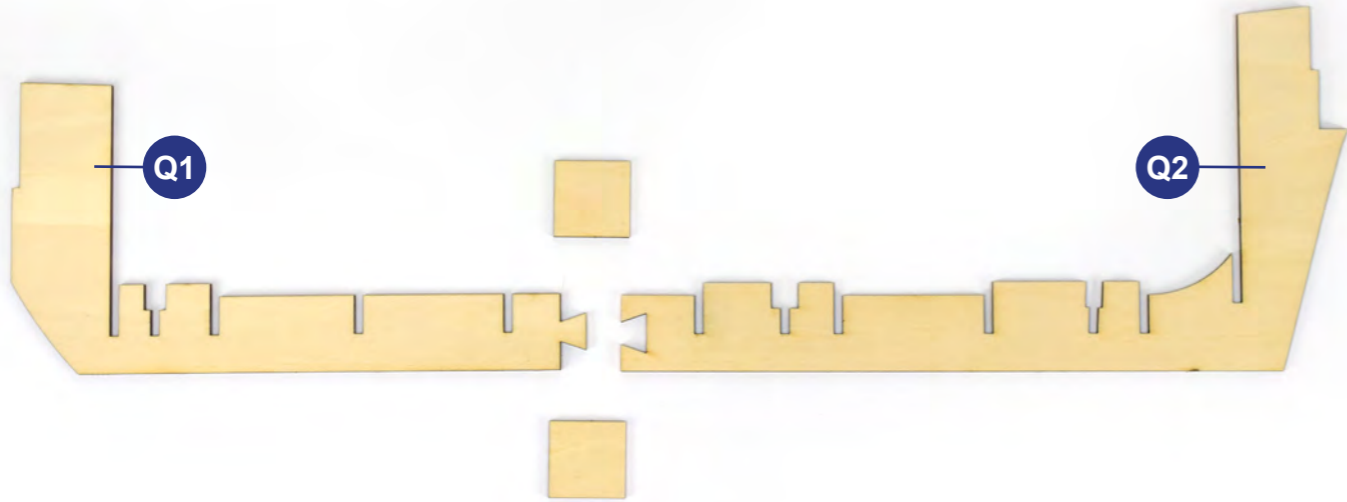

02

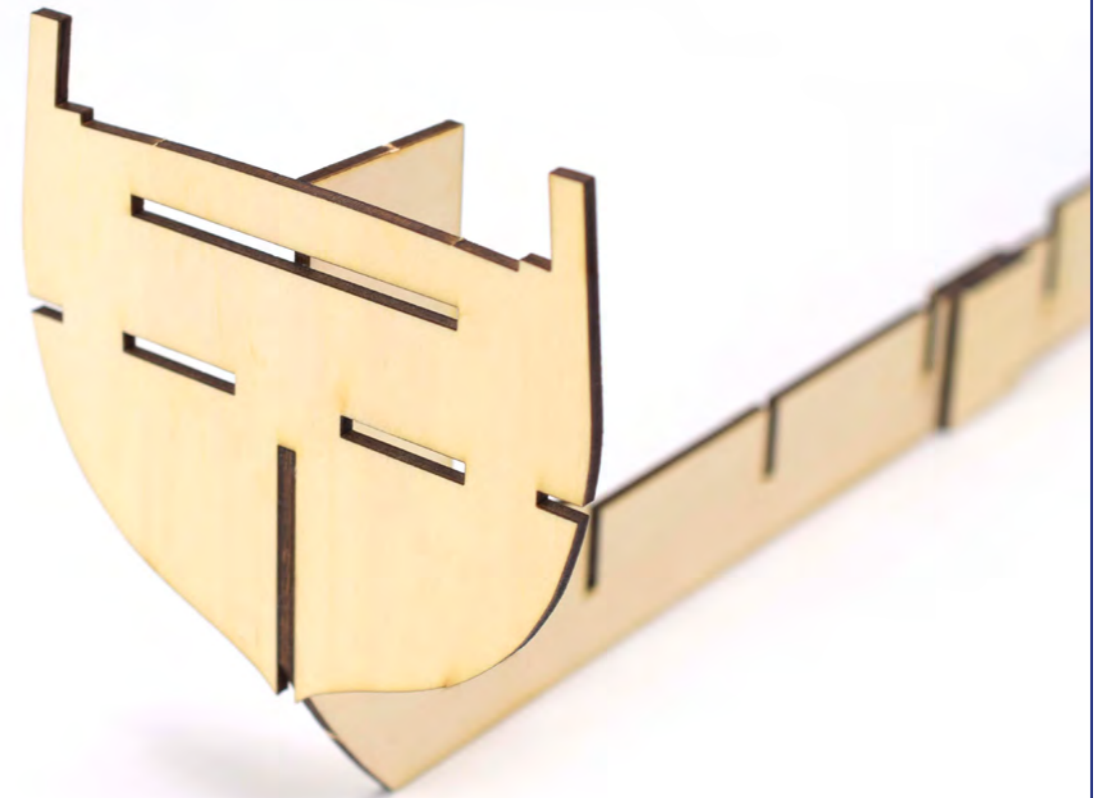
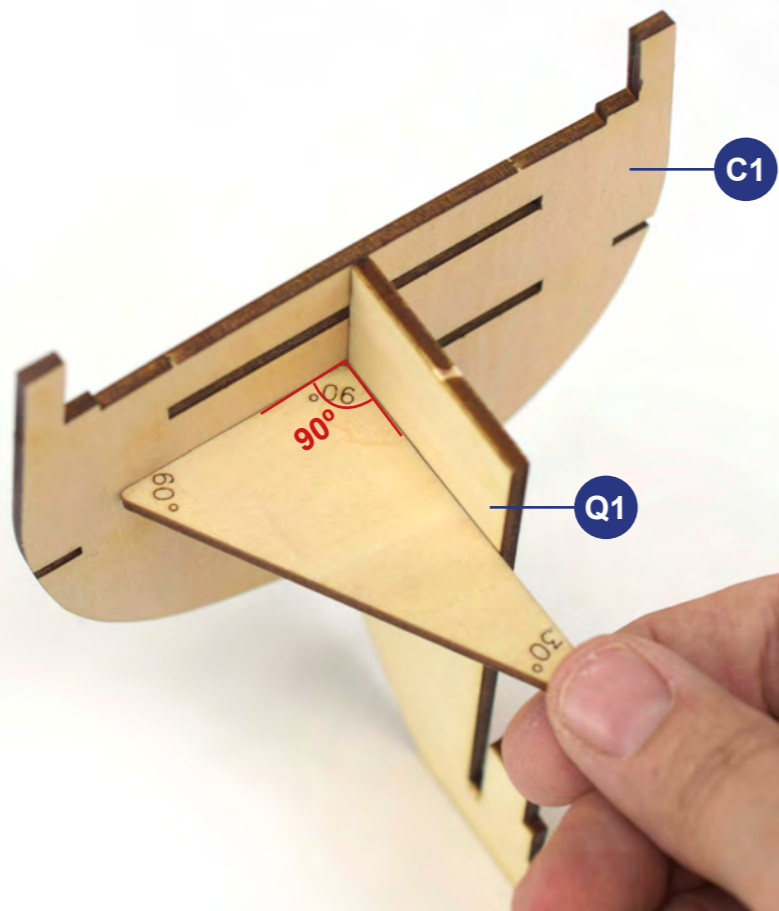
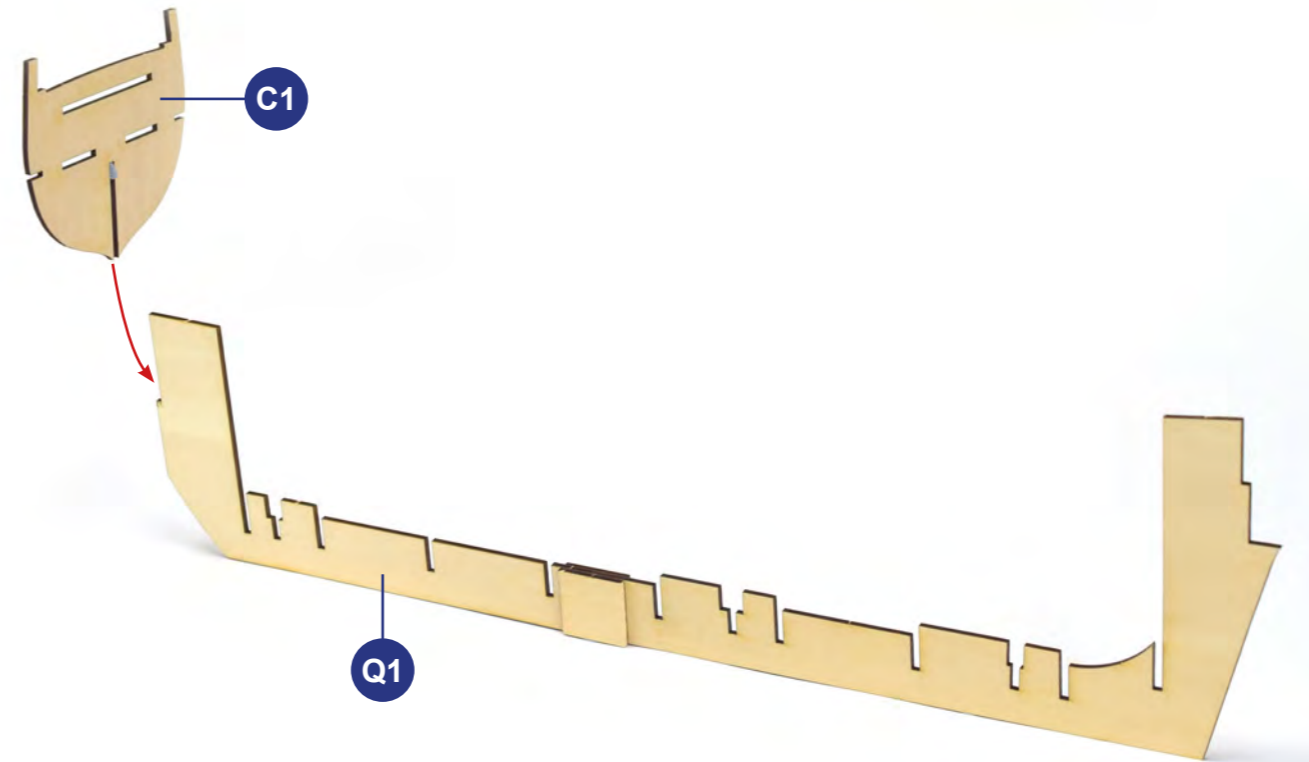
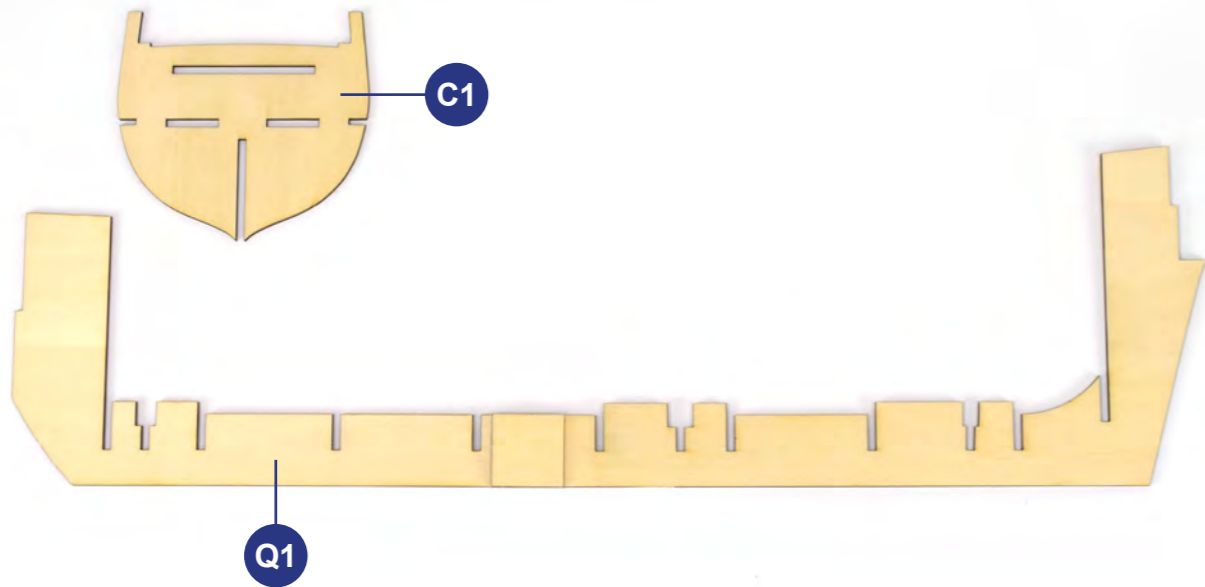

03

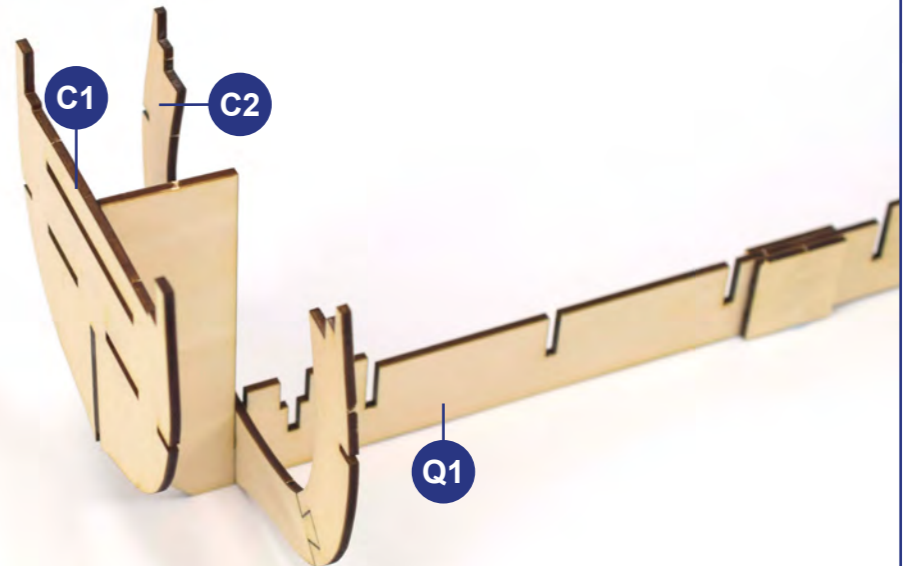
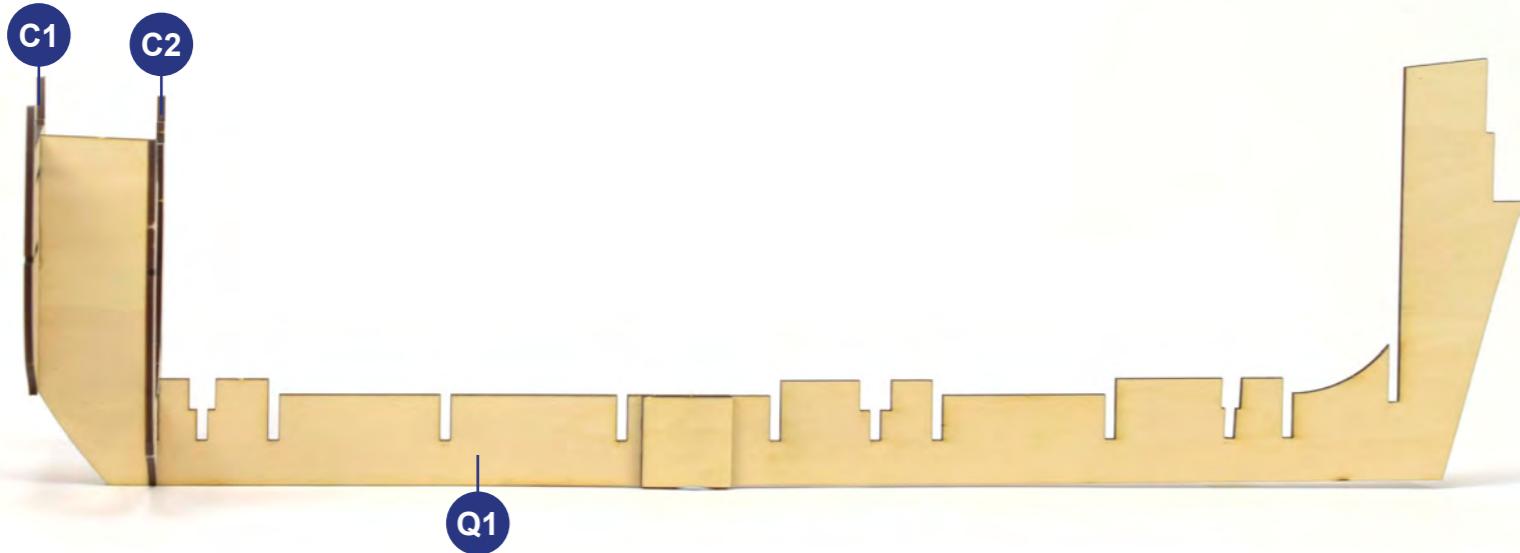
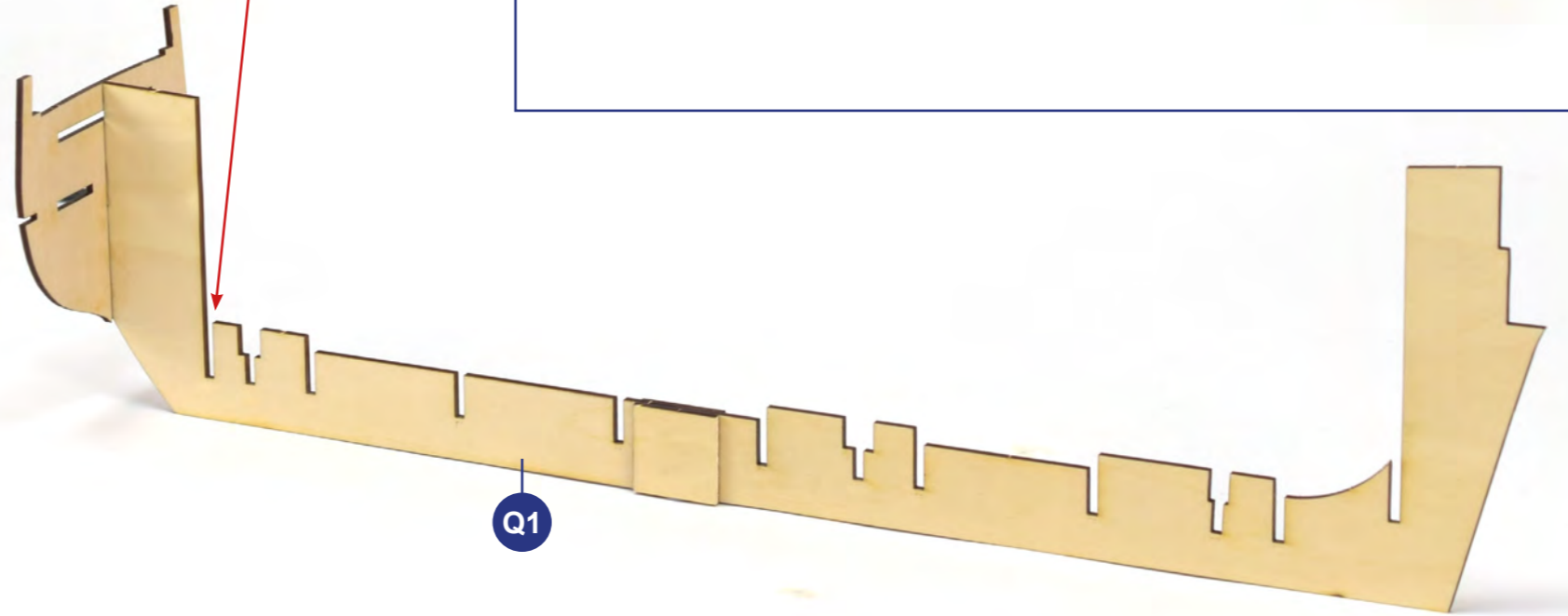
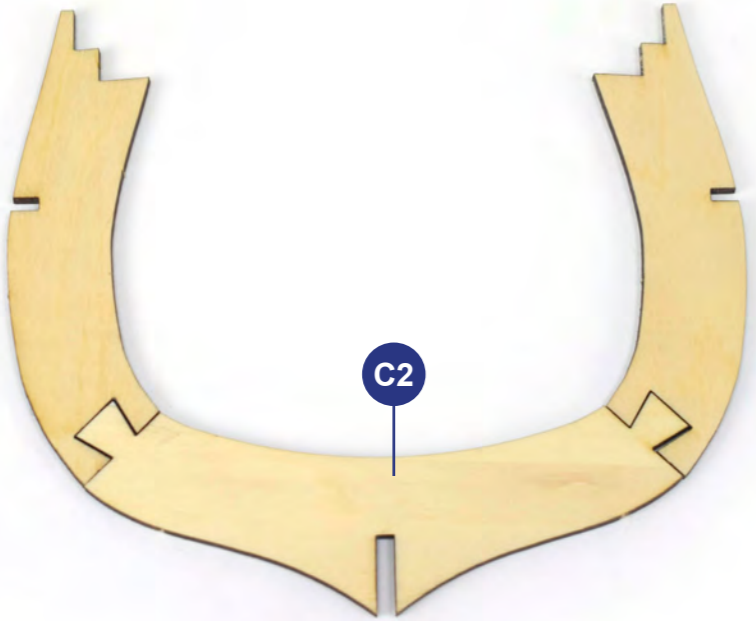
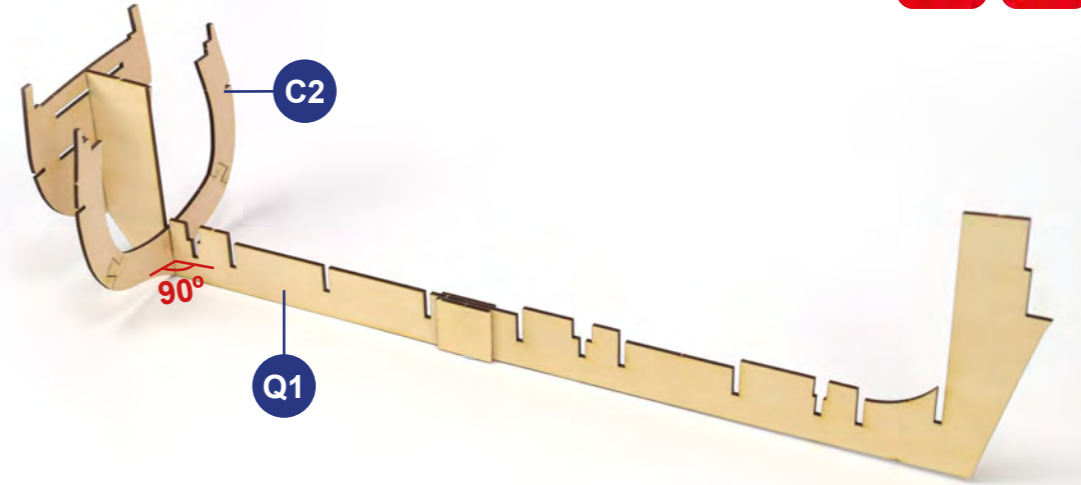
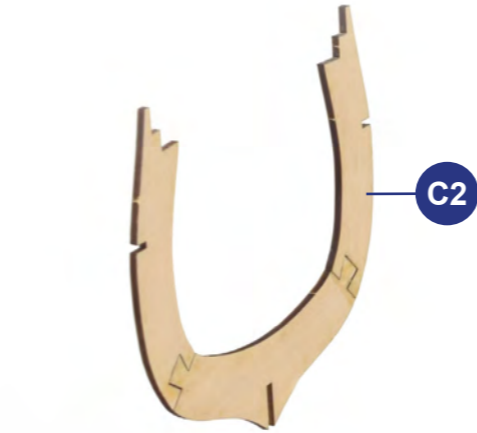

04

R

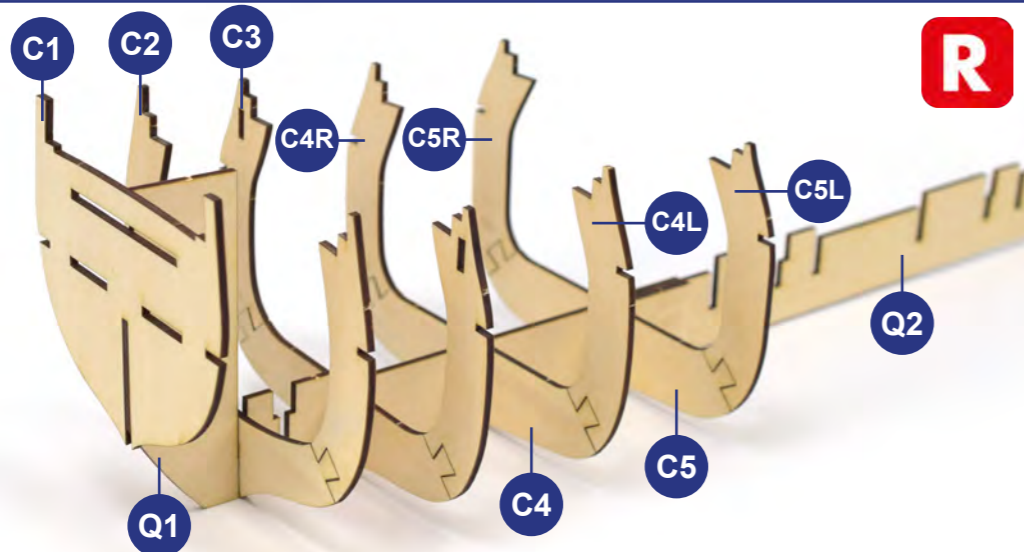
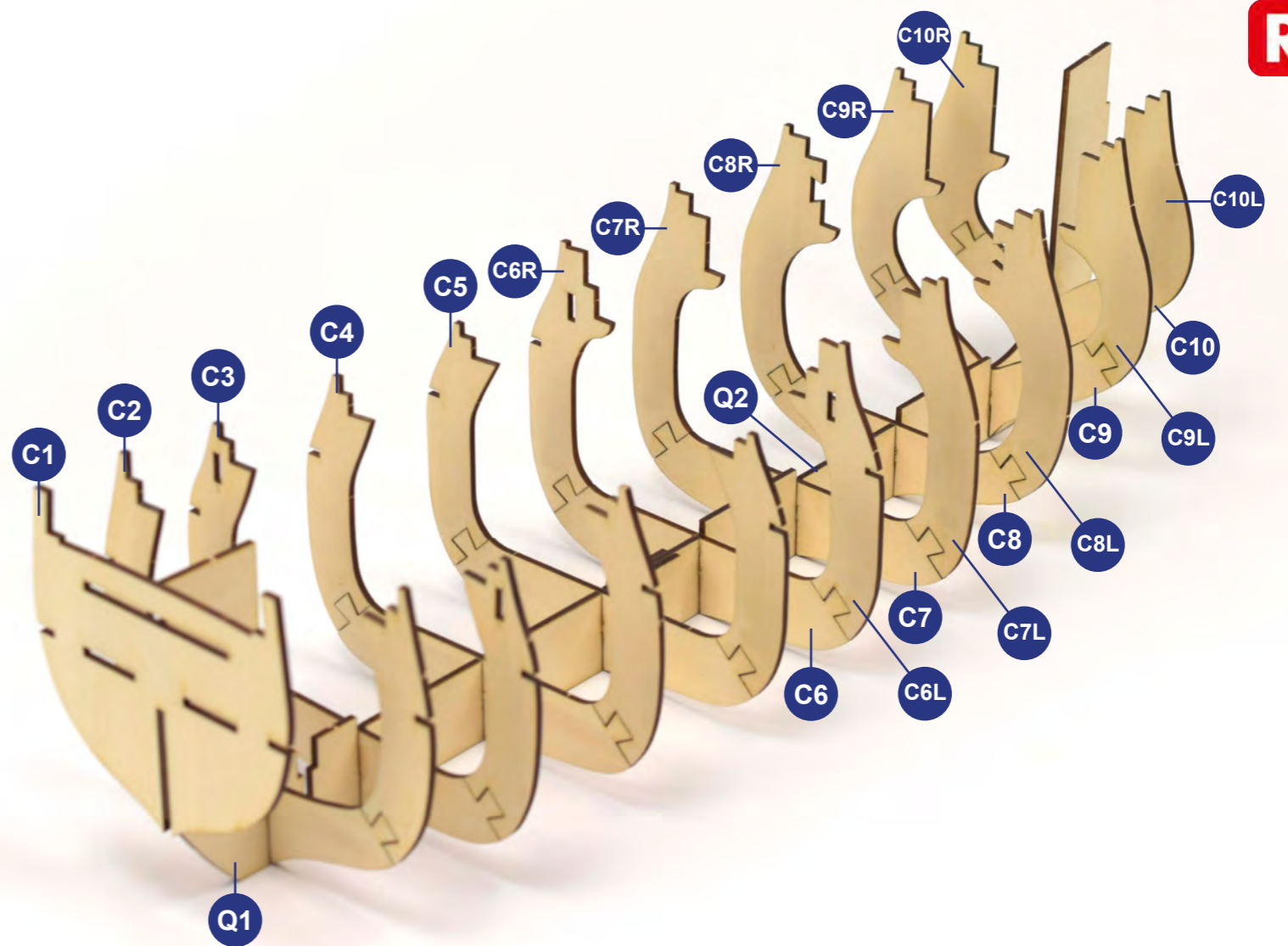
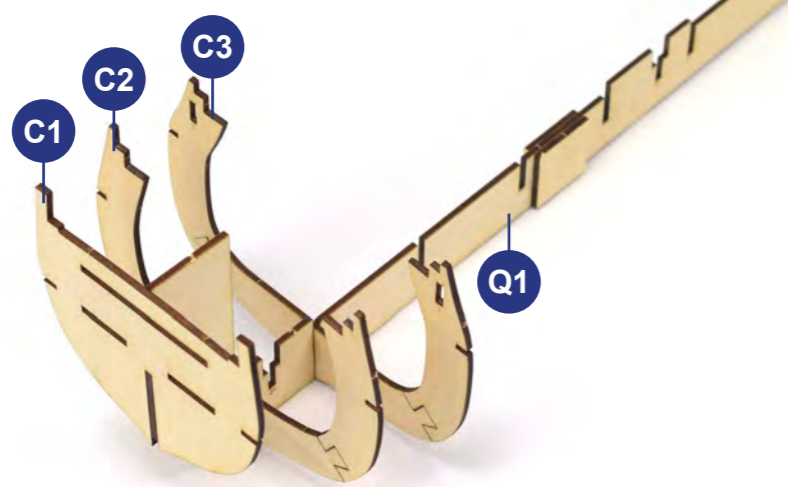
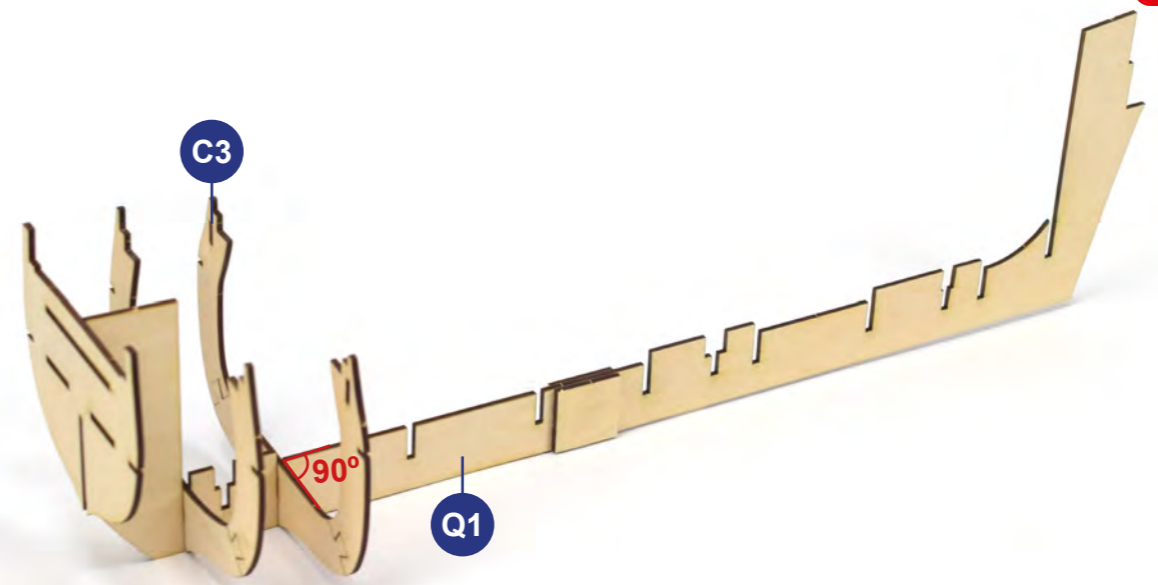
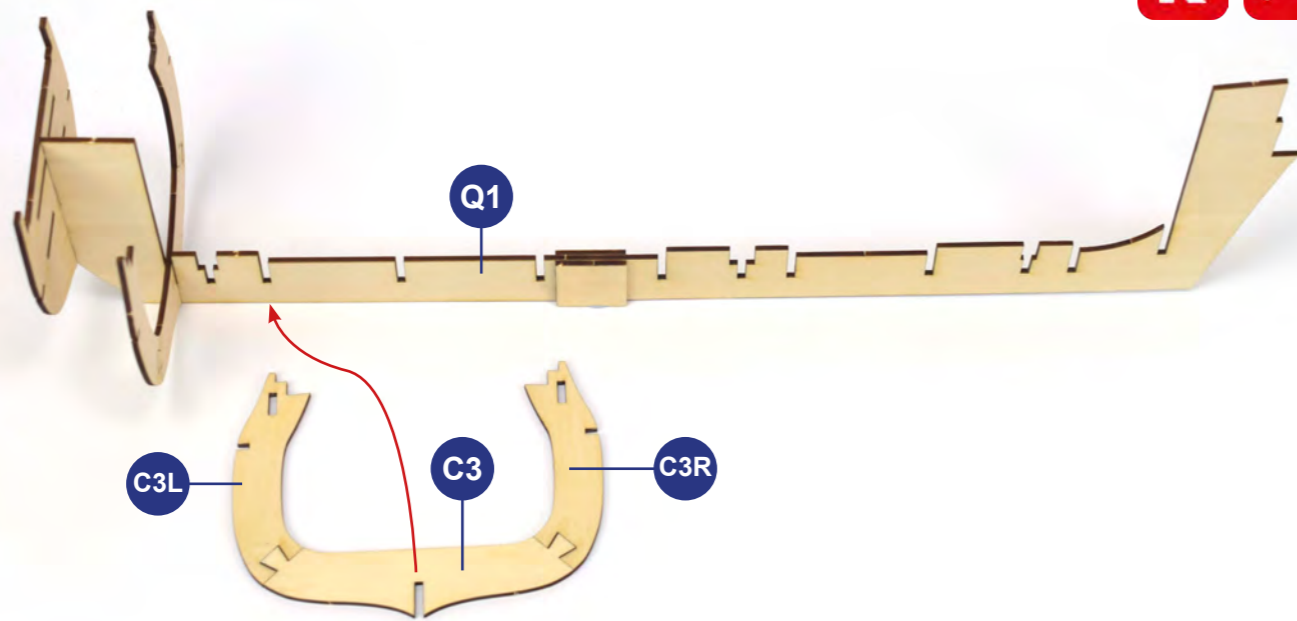

05

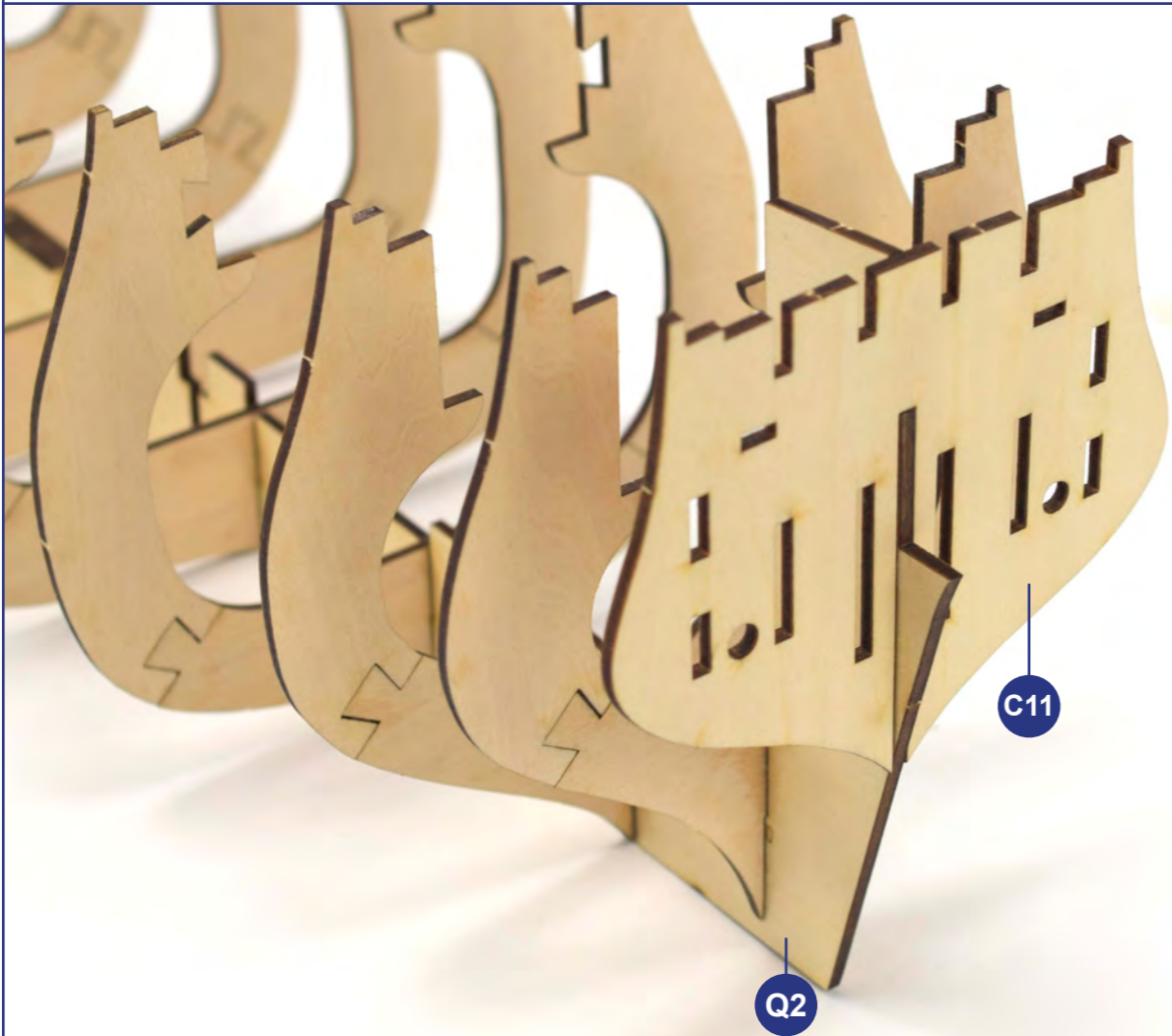
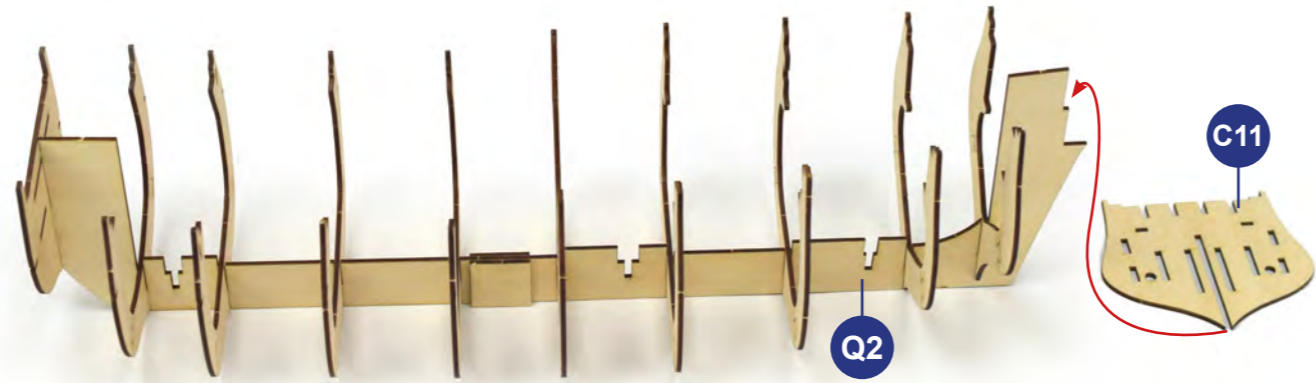

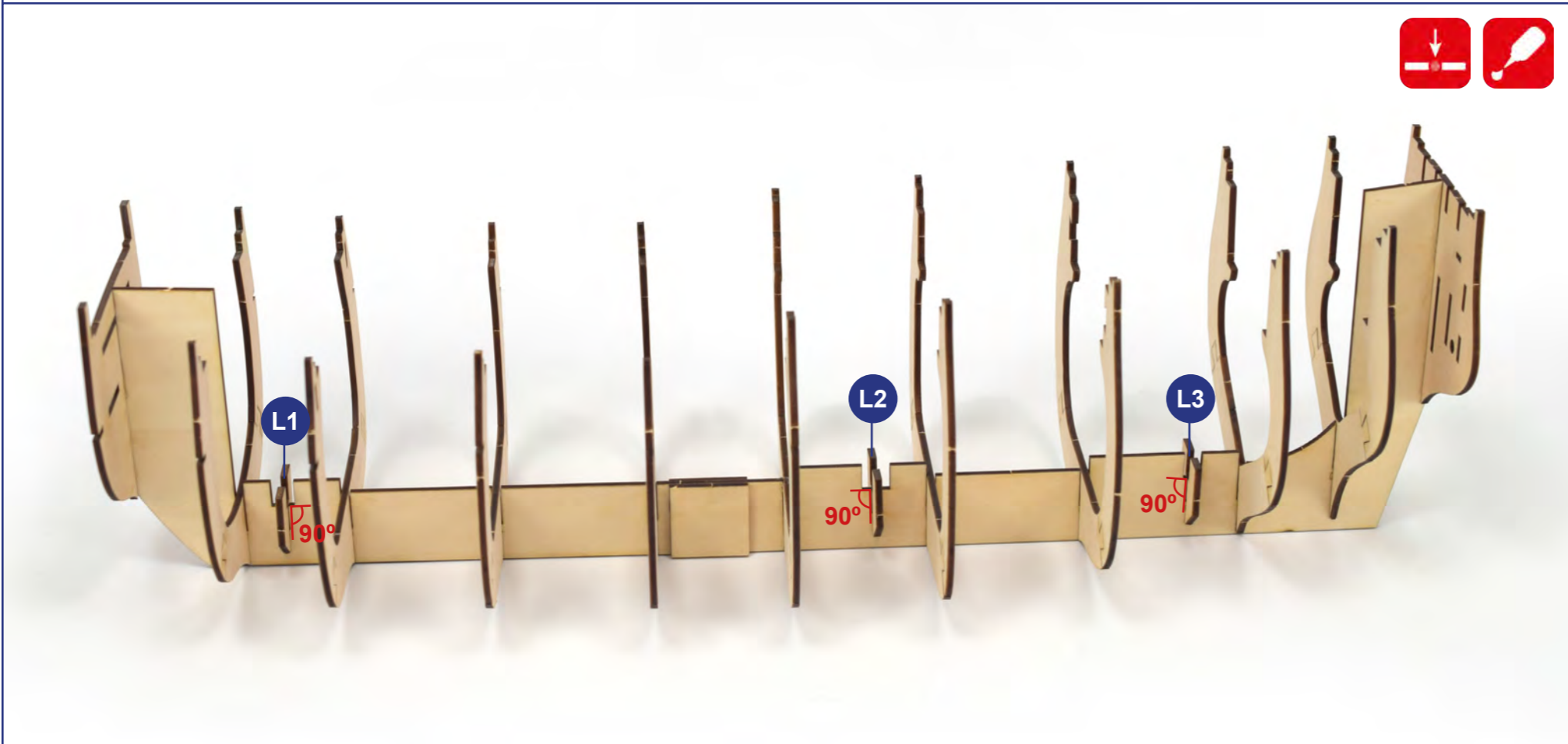
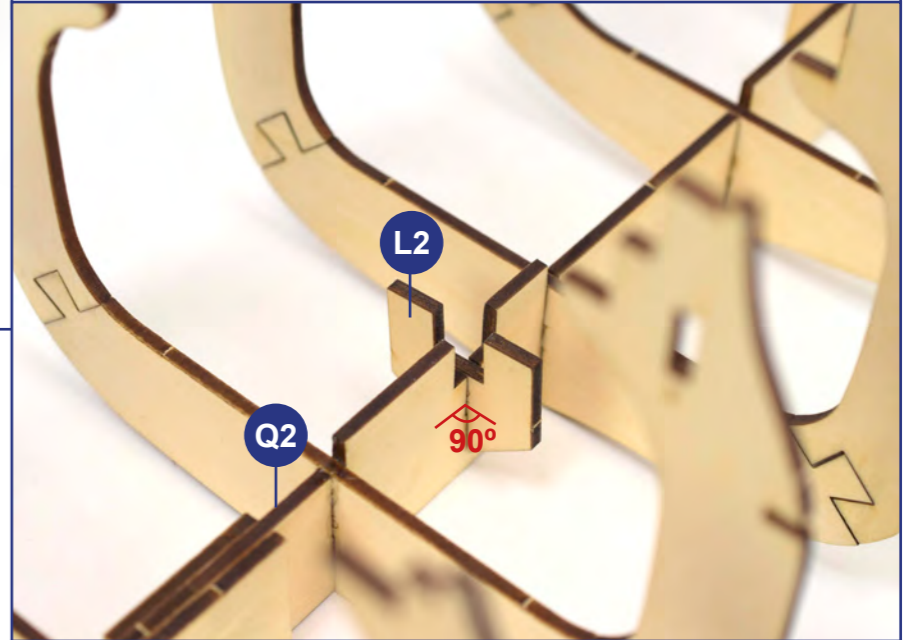
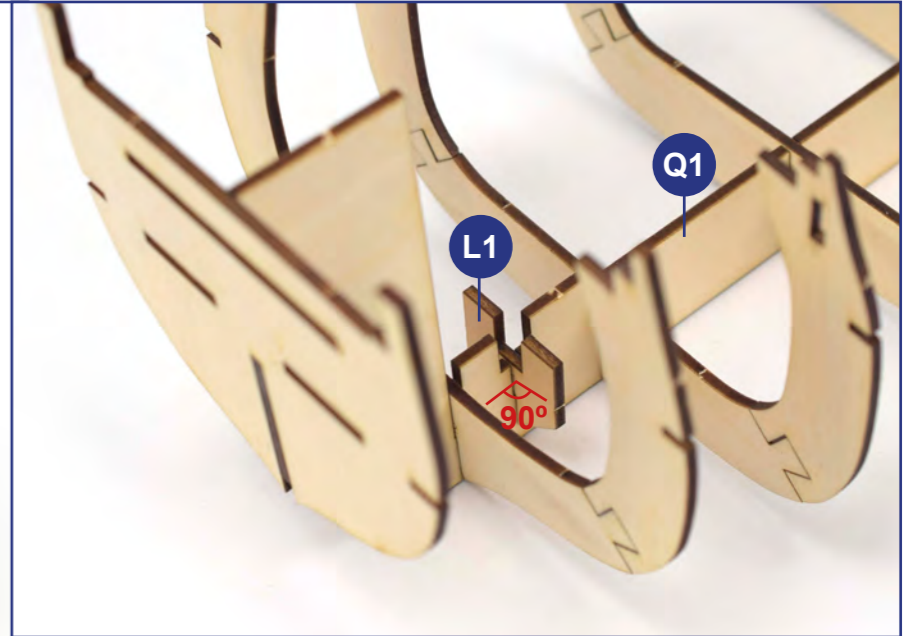
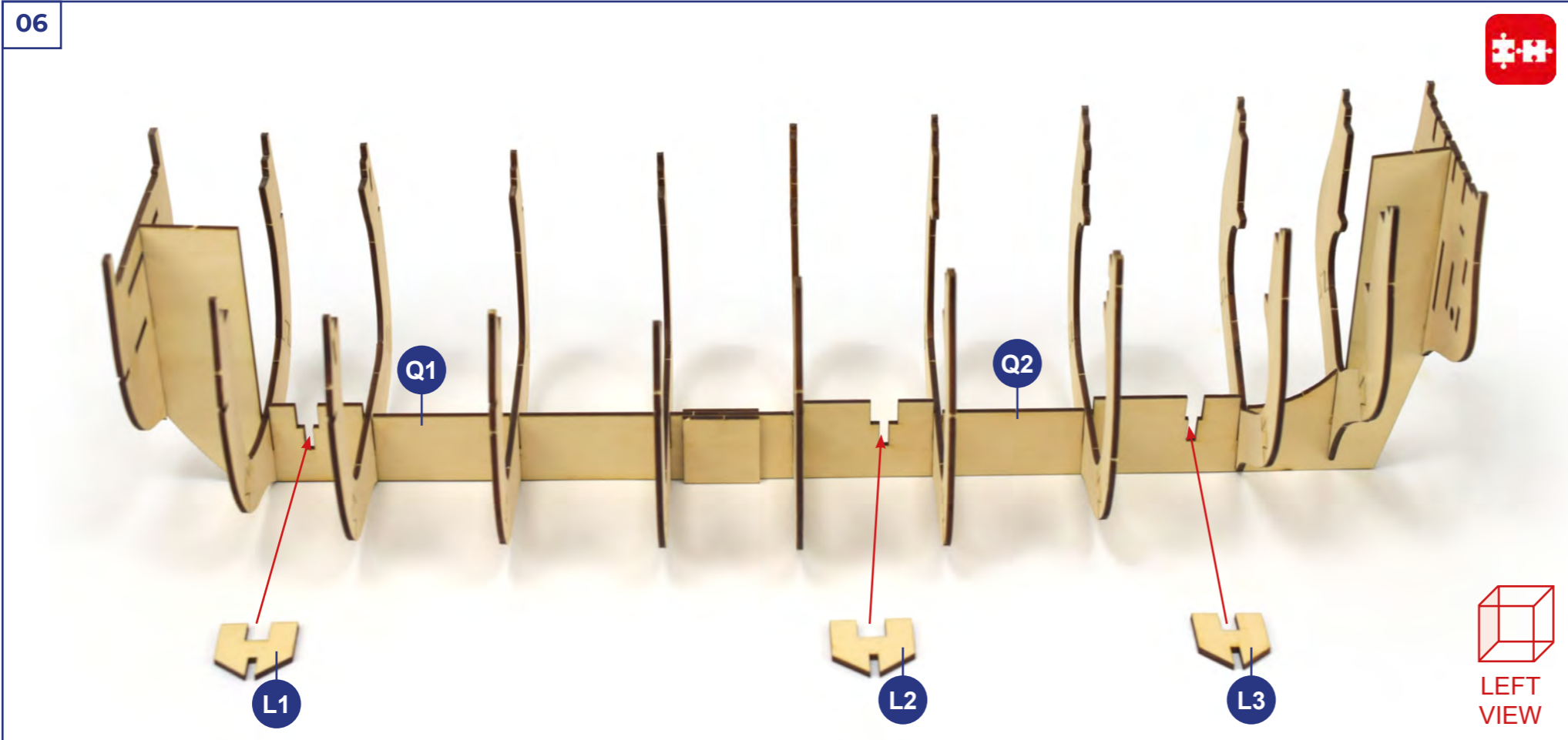

07

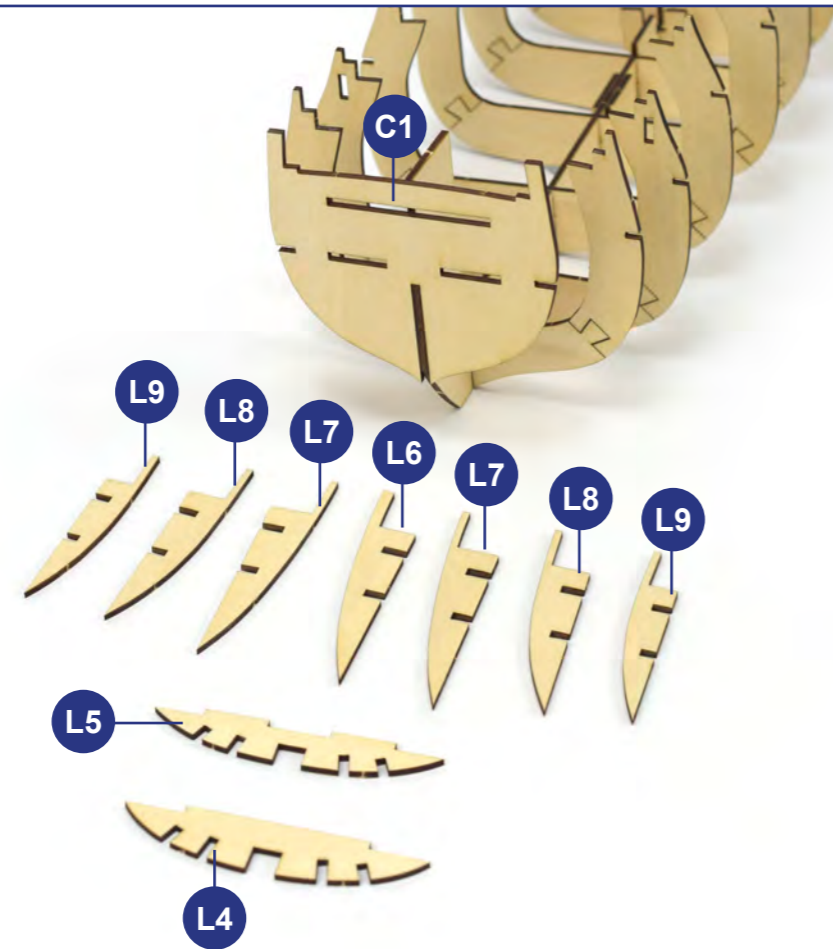

LEFT VIEW

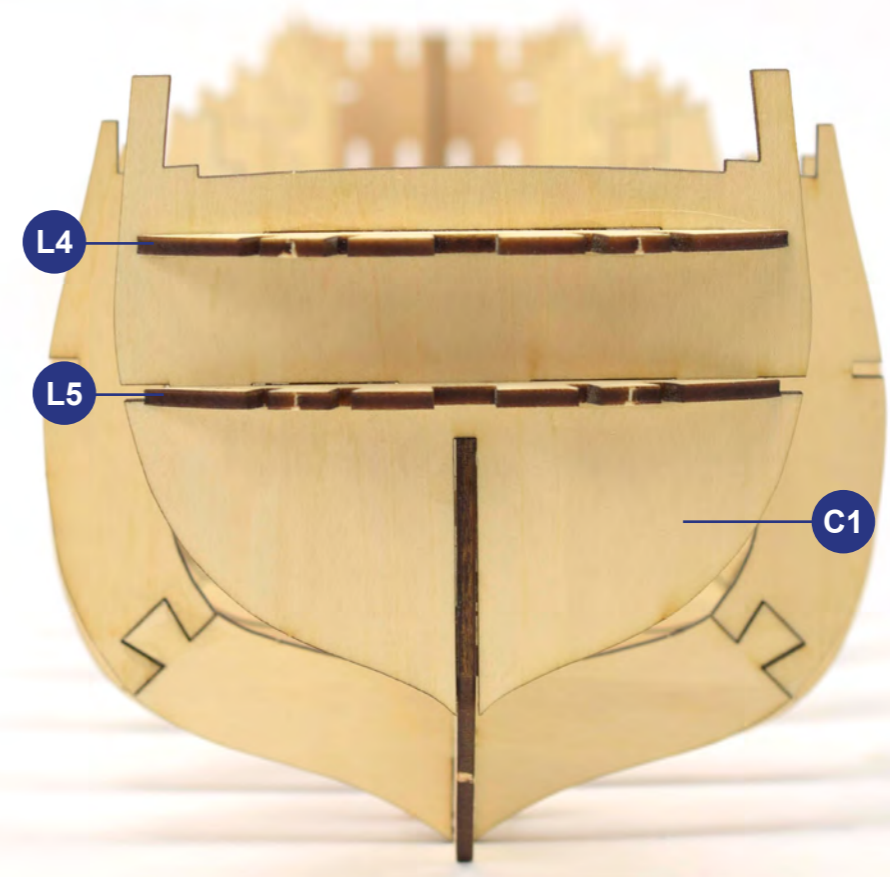

FRONT VIEW

08

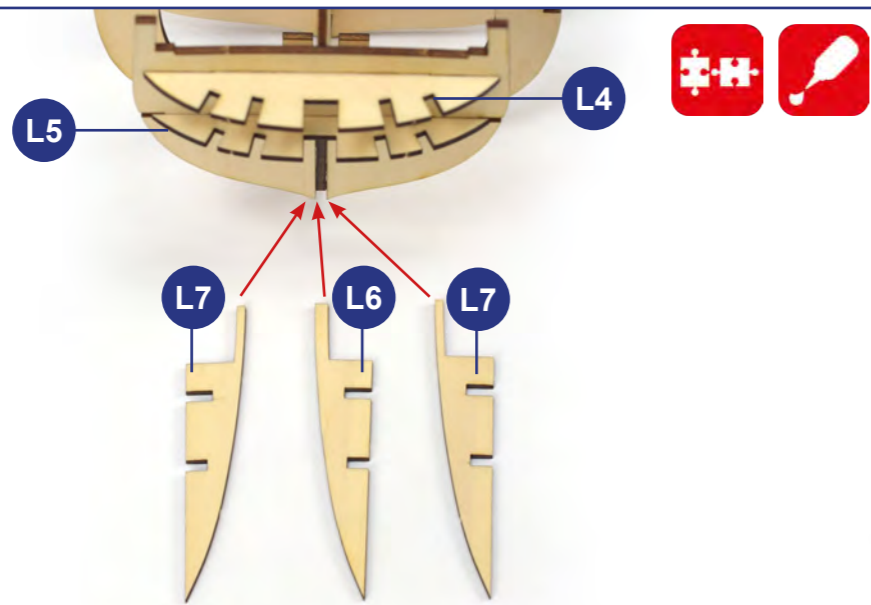

09

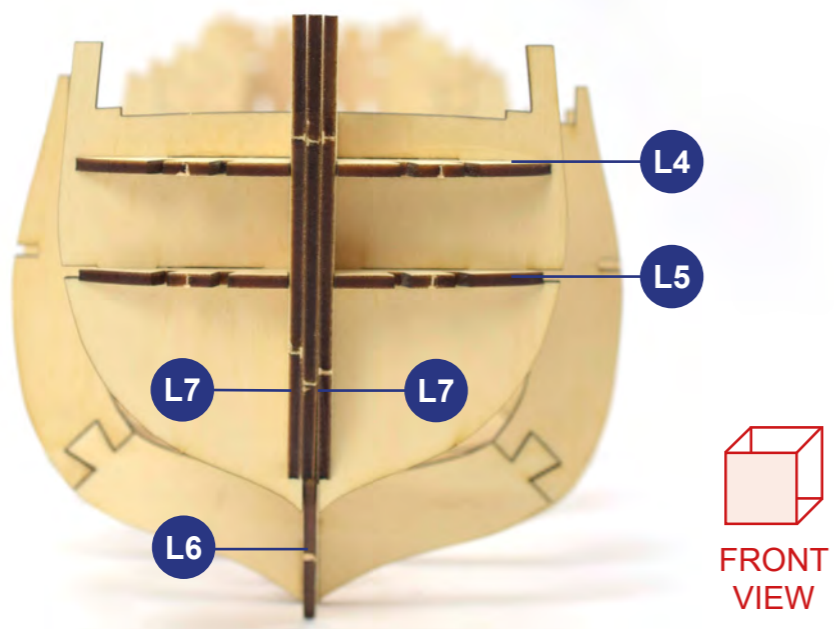
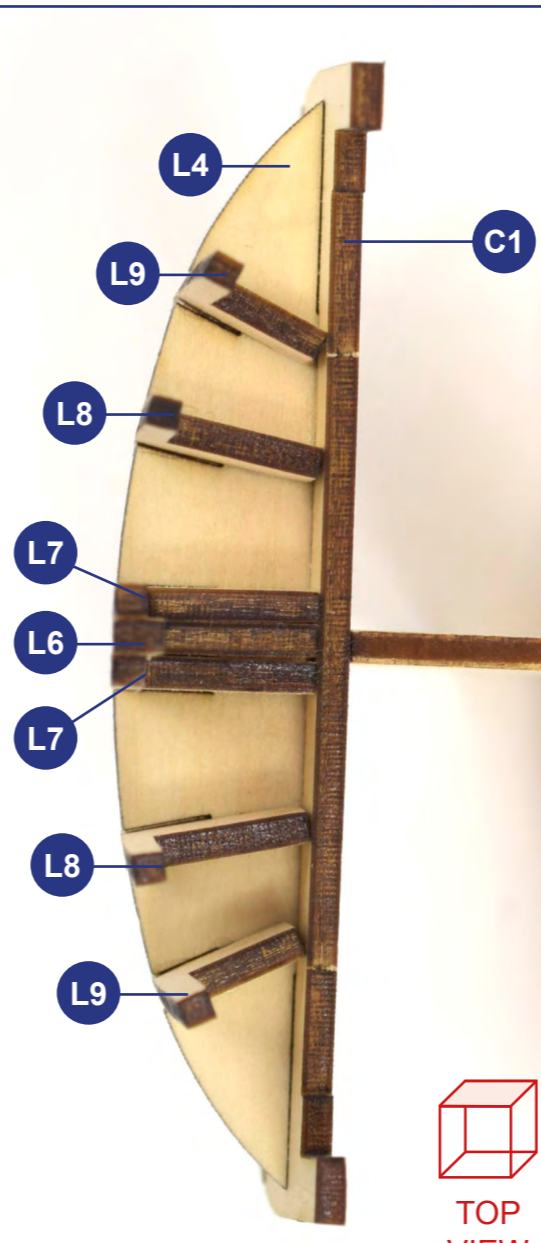
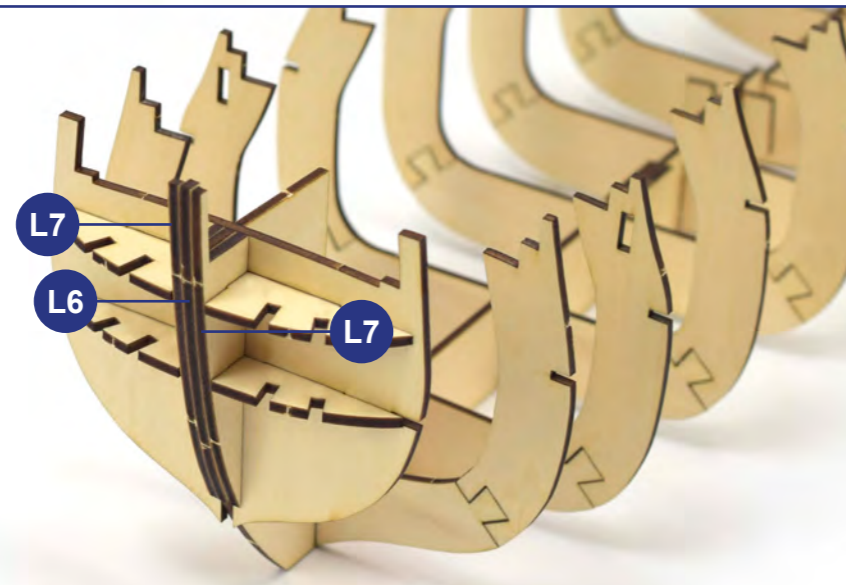
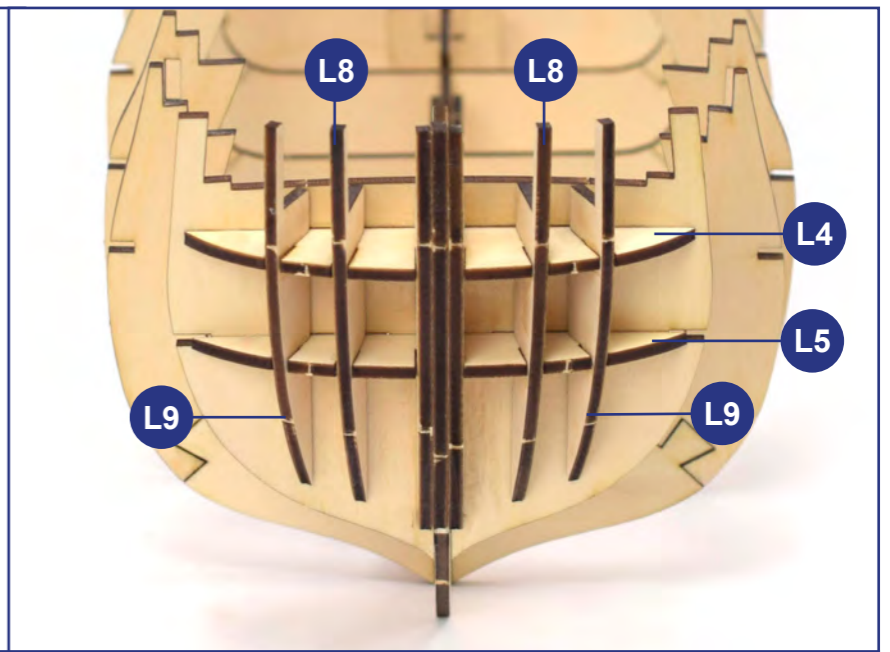
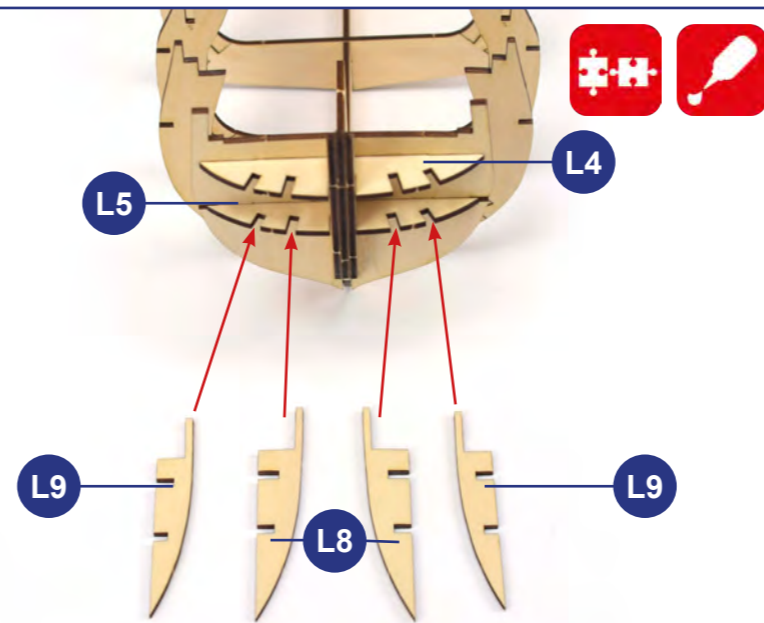

10

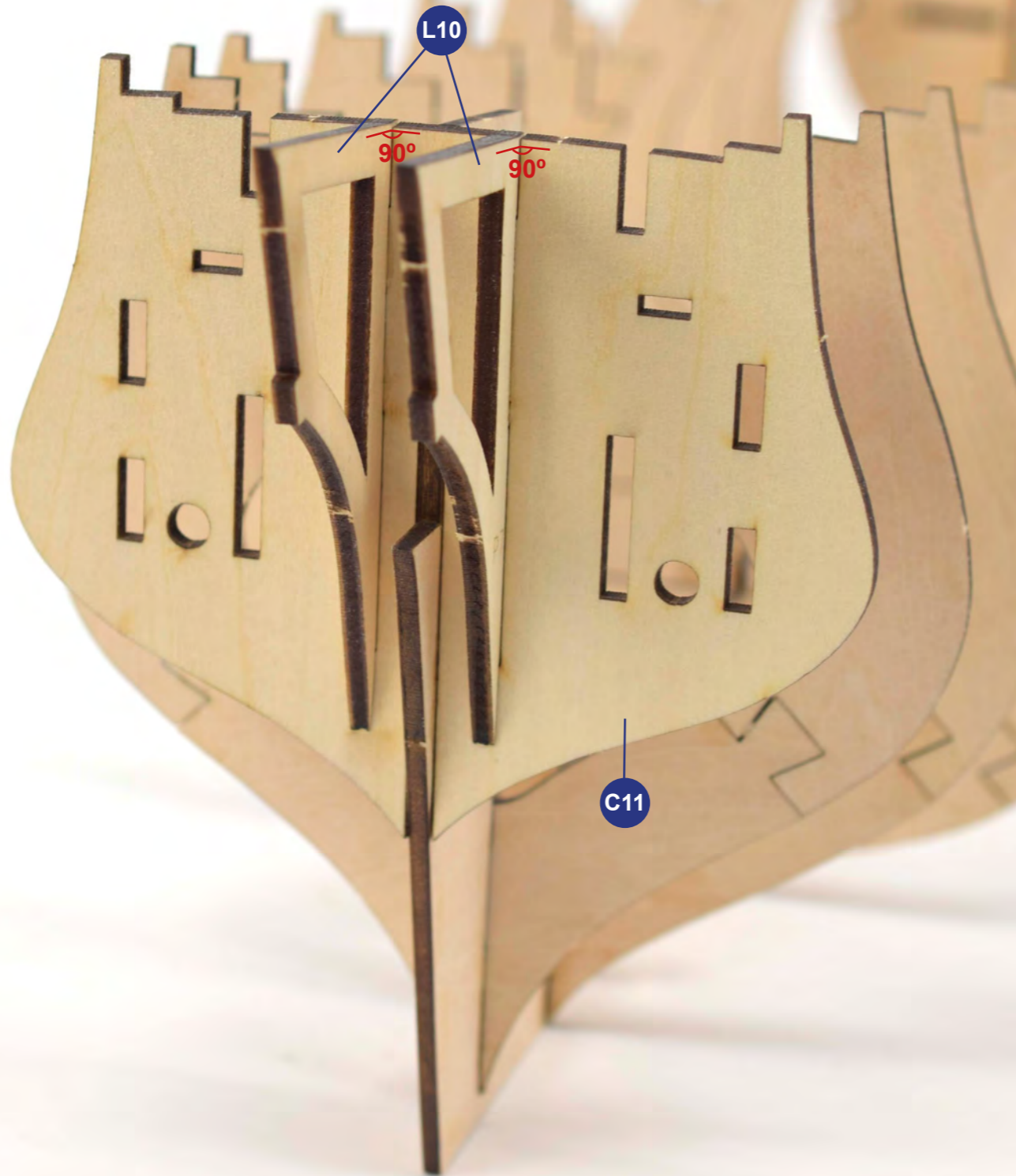

11

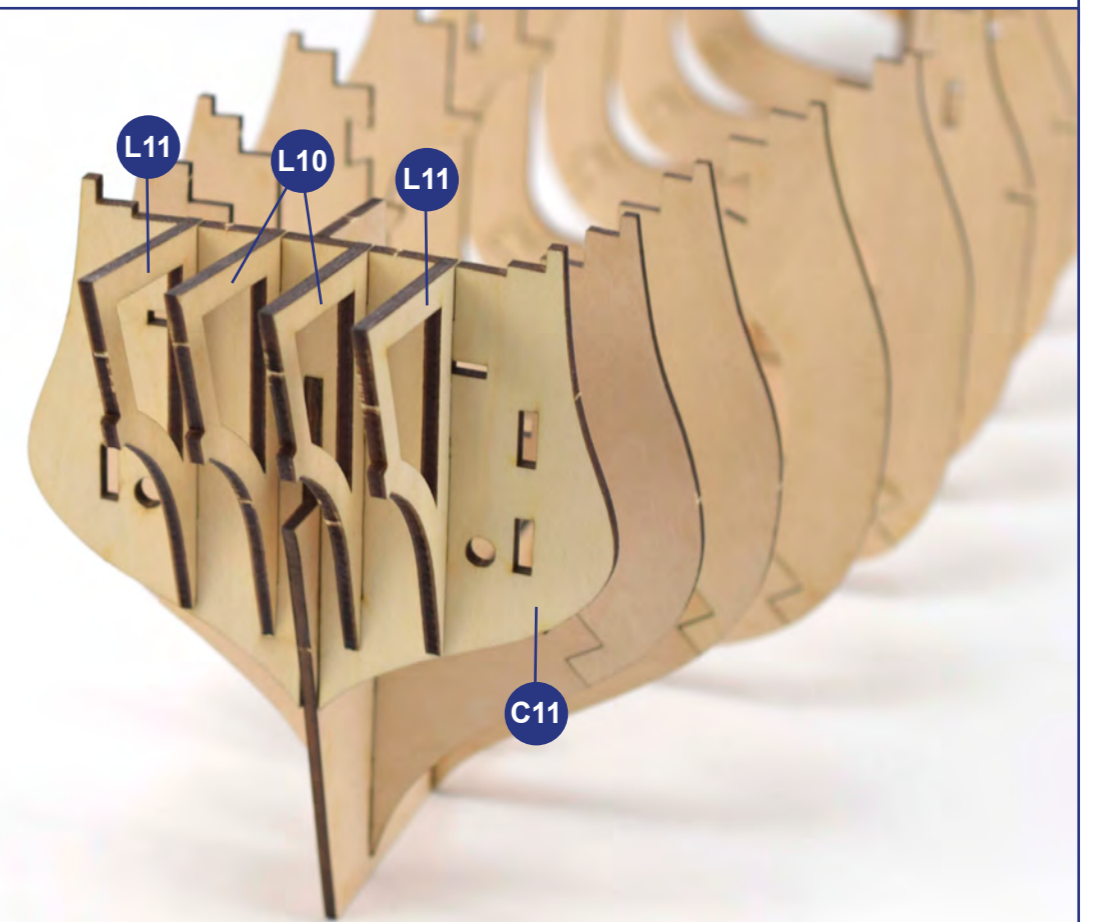
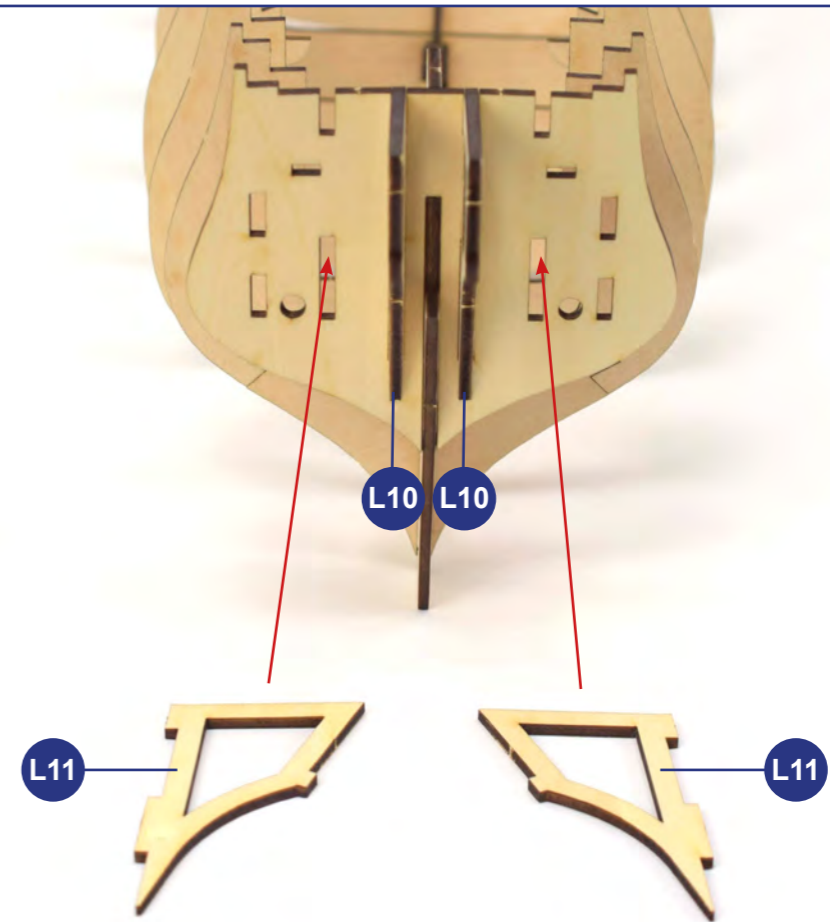

12

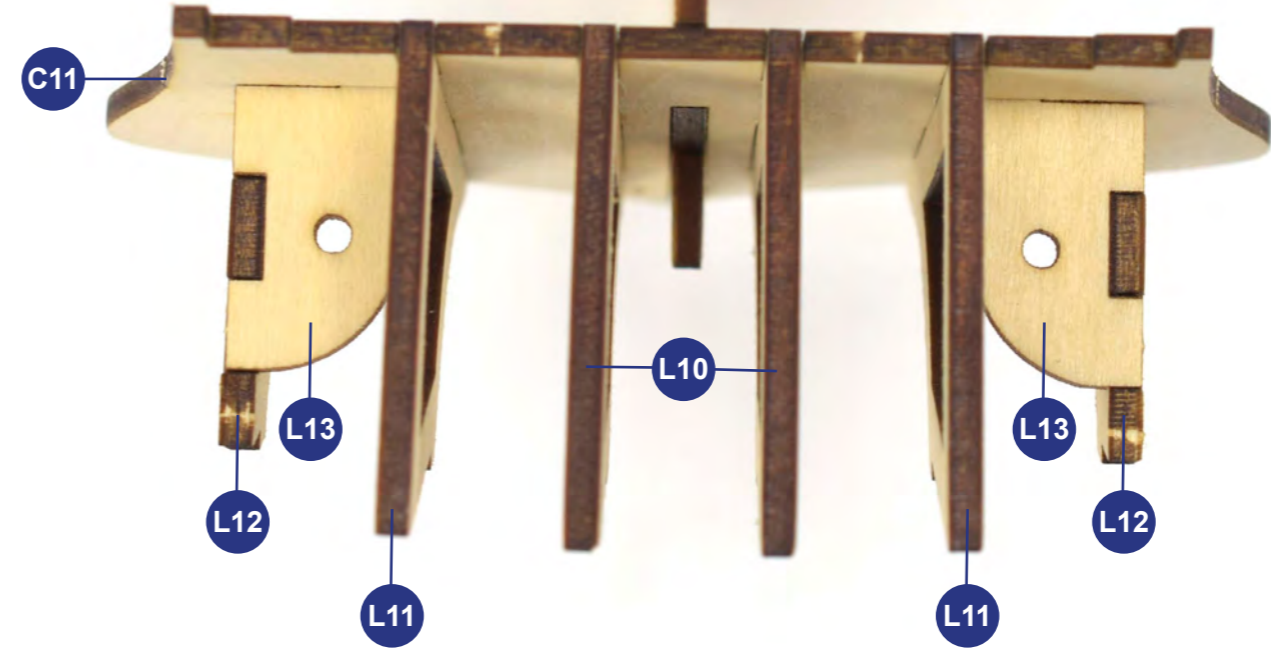
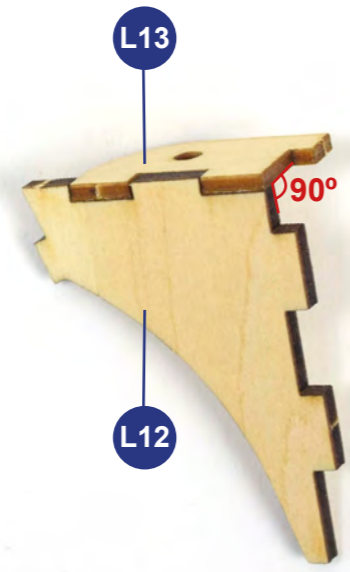
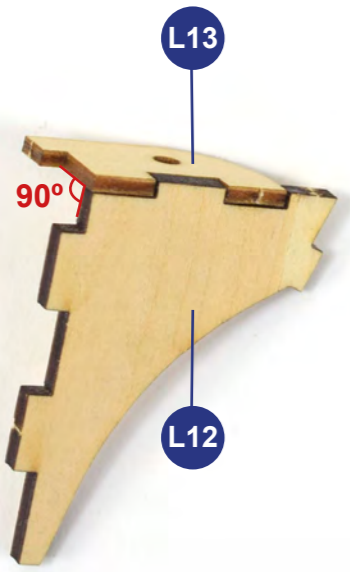
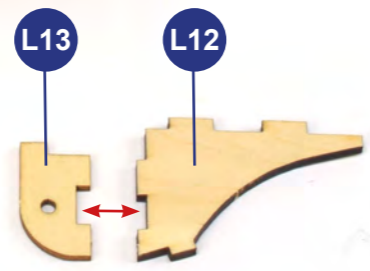
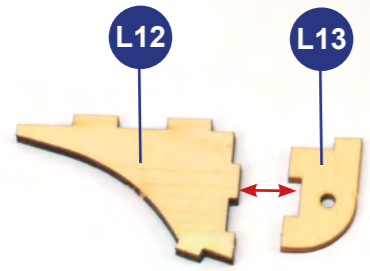
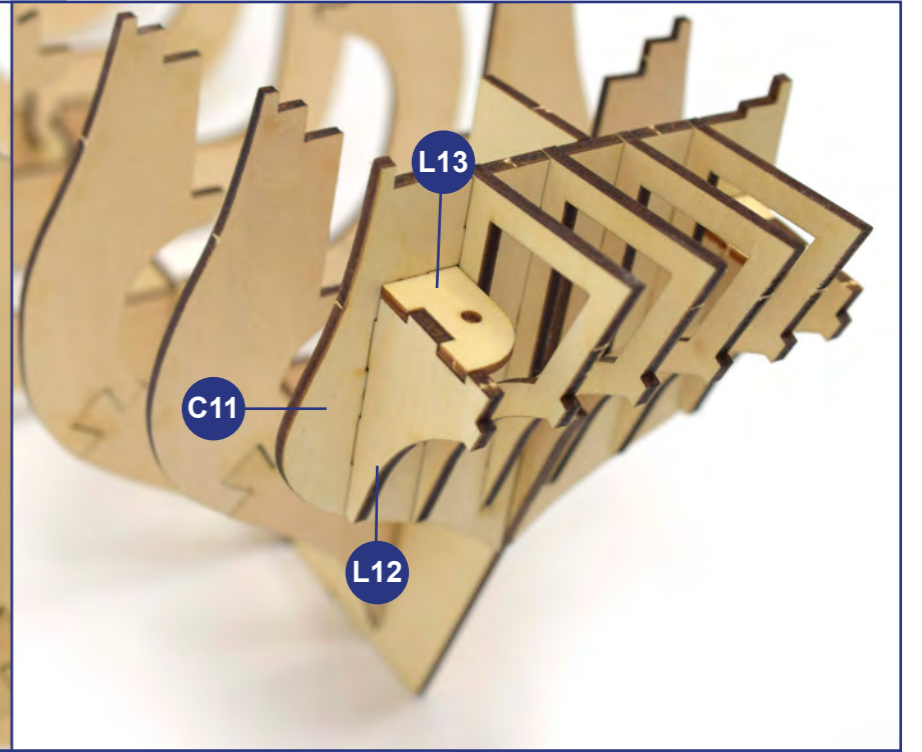
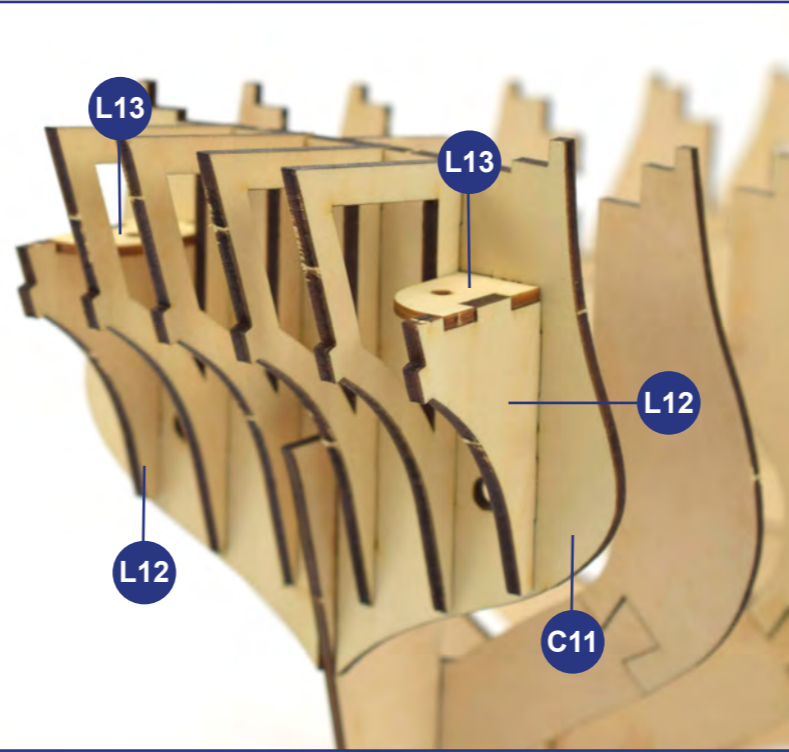
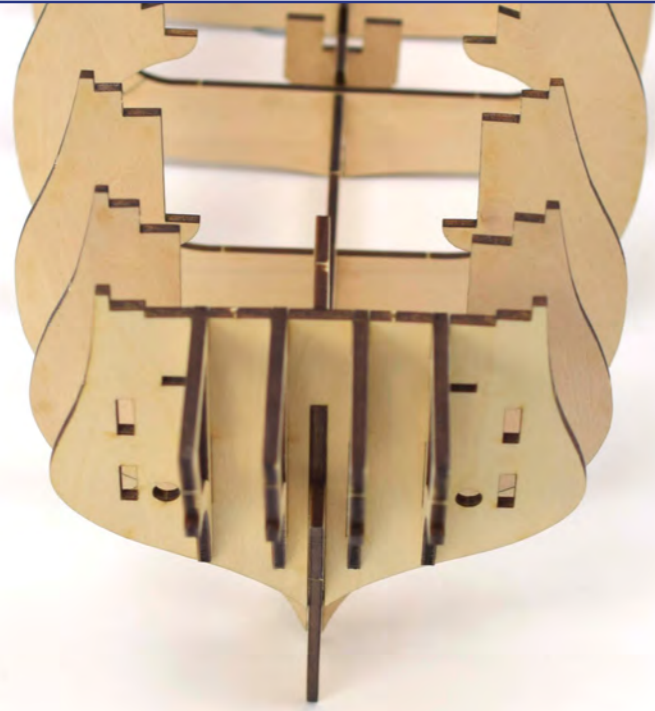

13

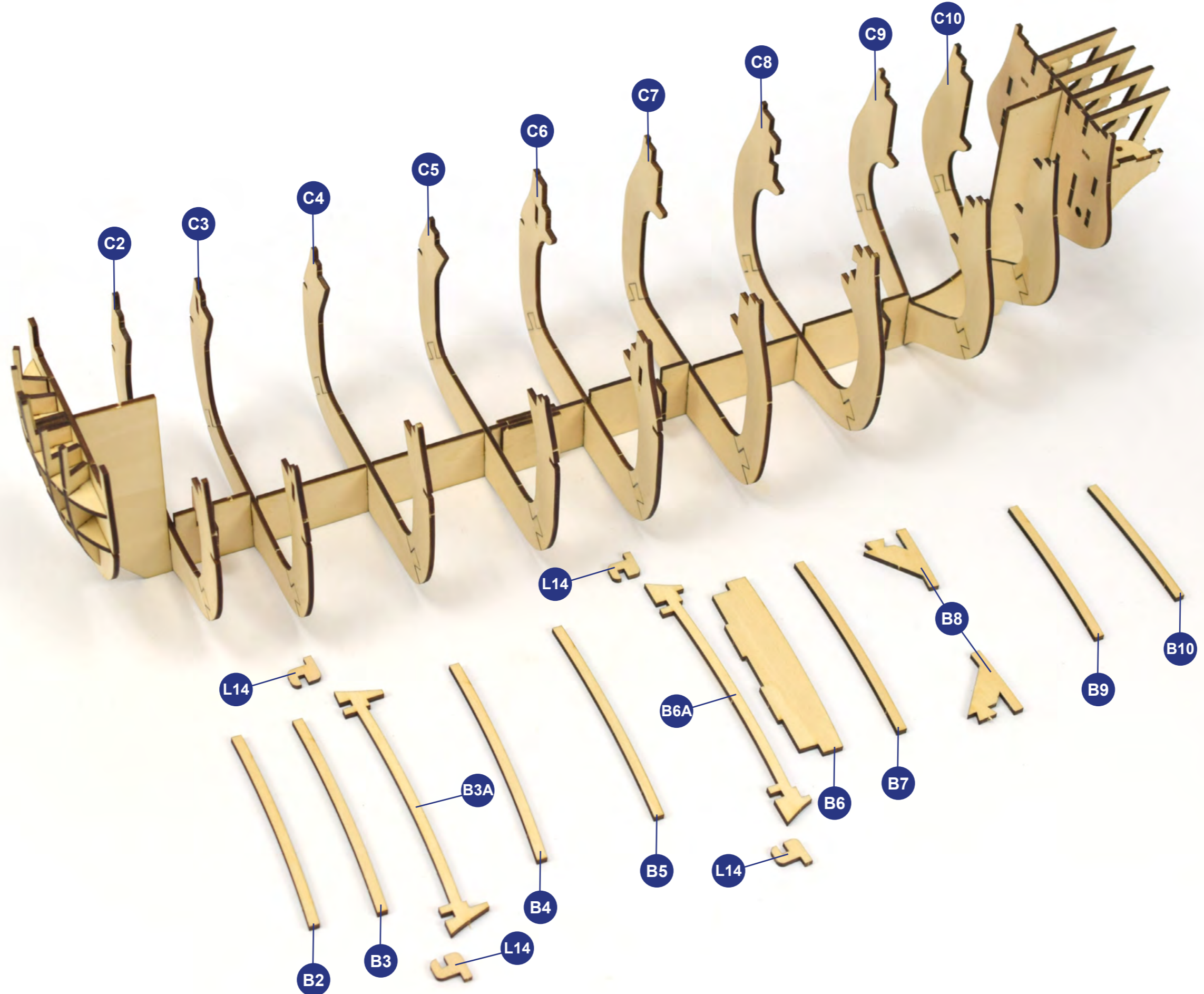

14

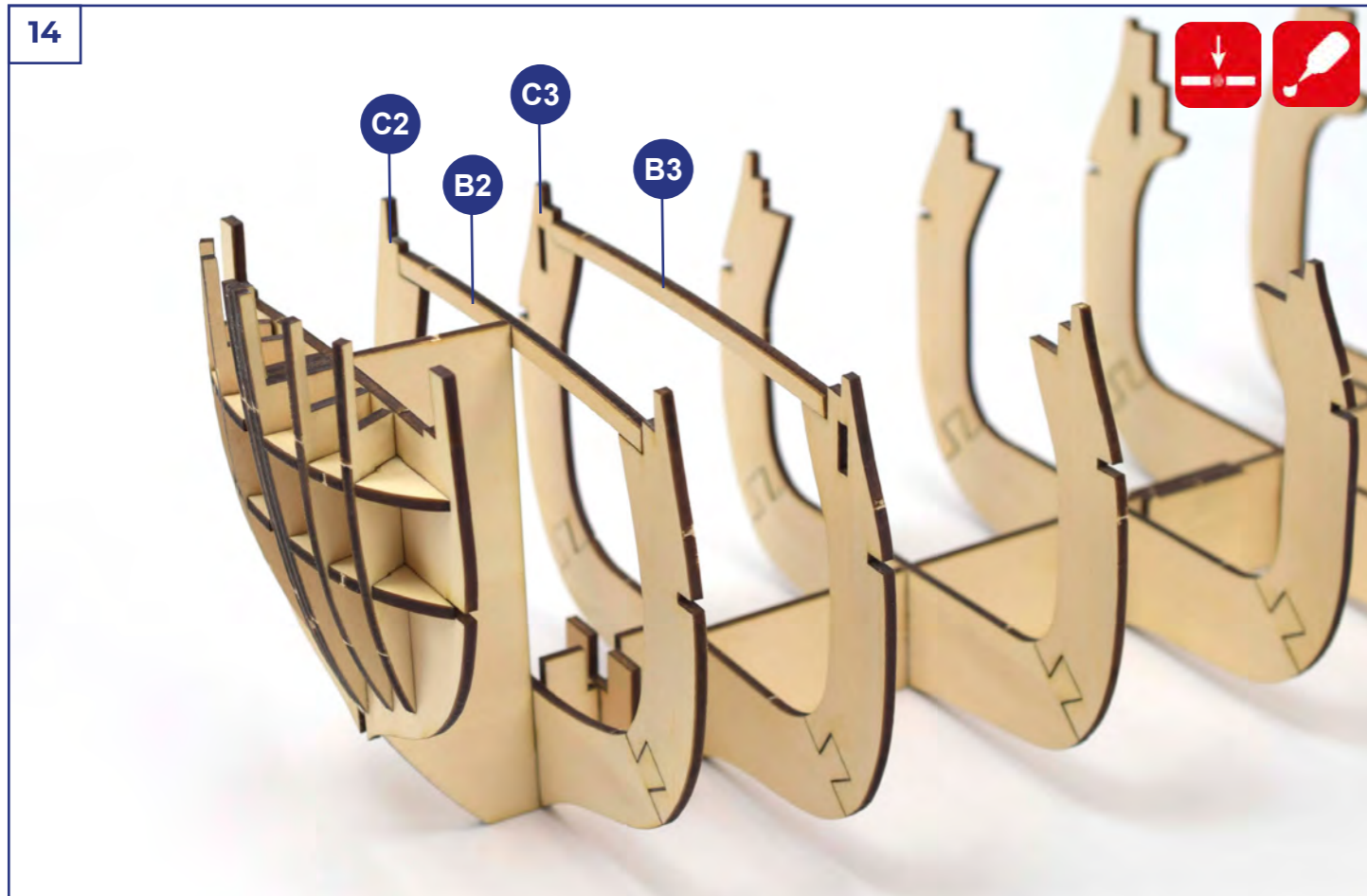

15

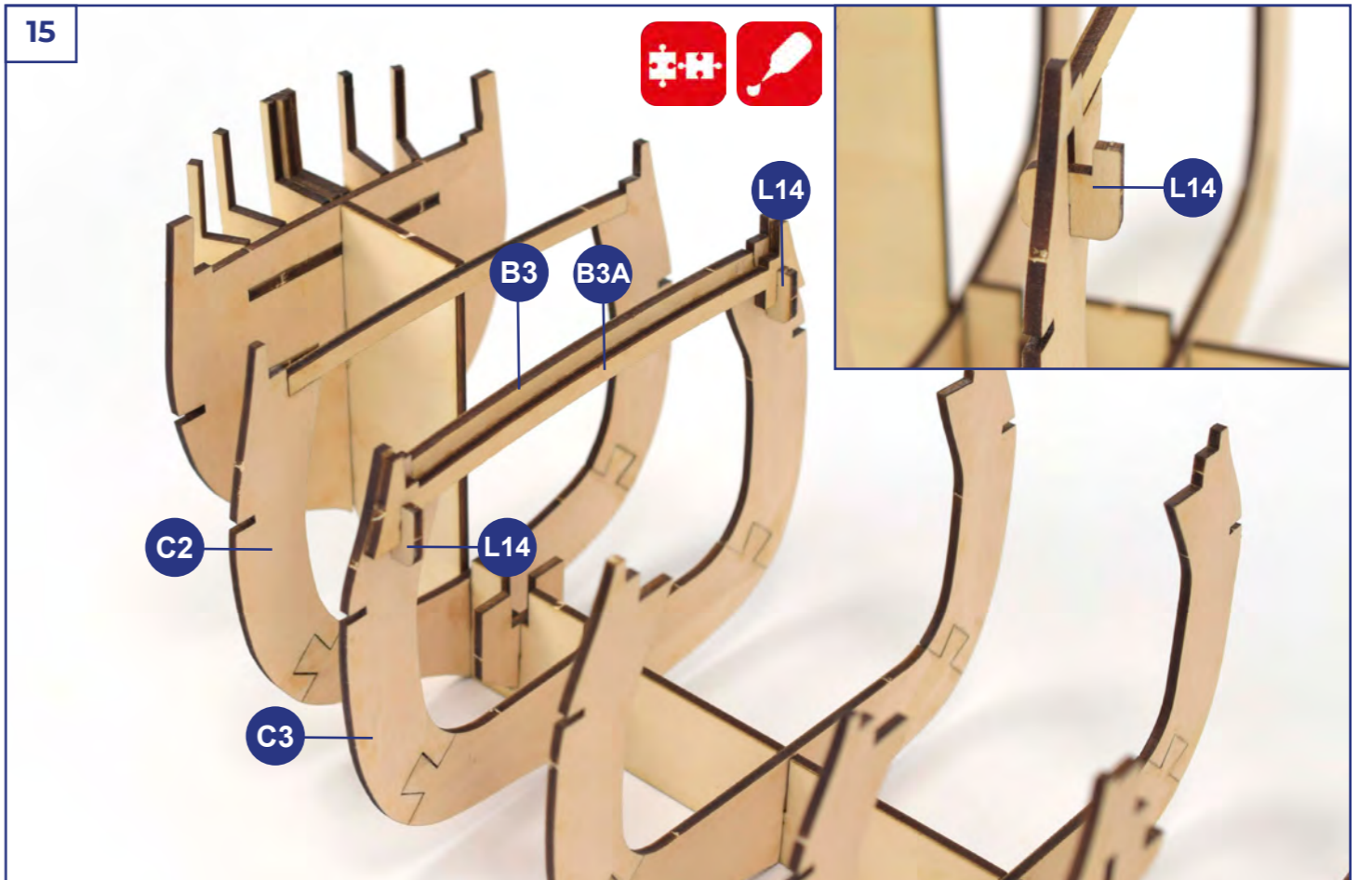

16

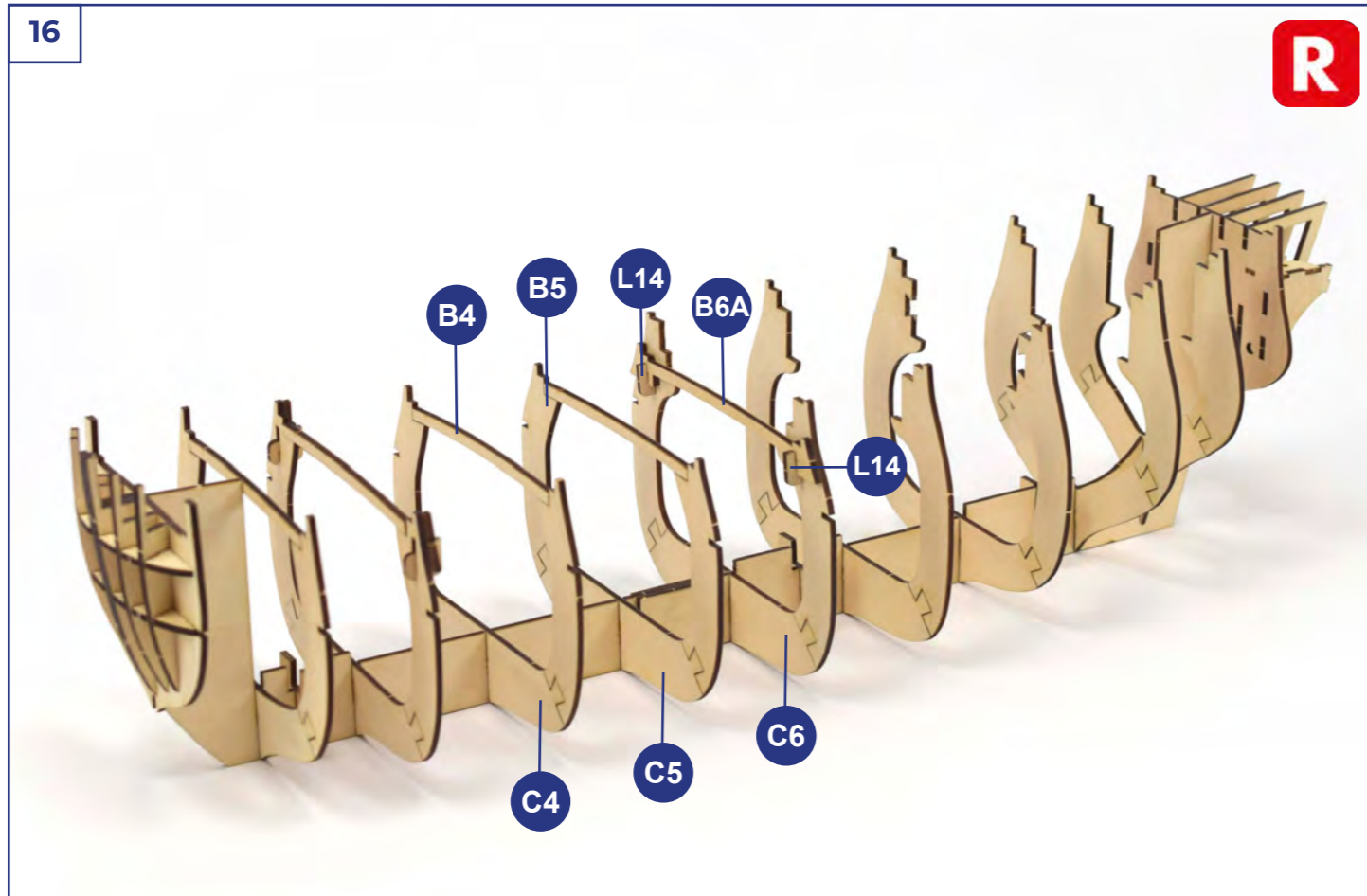

17

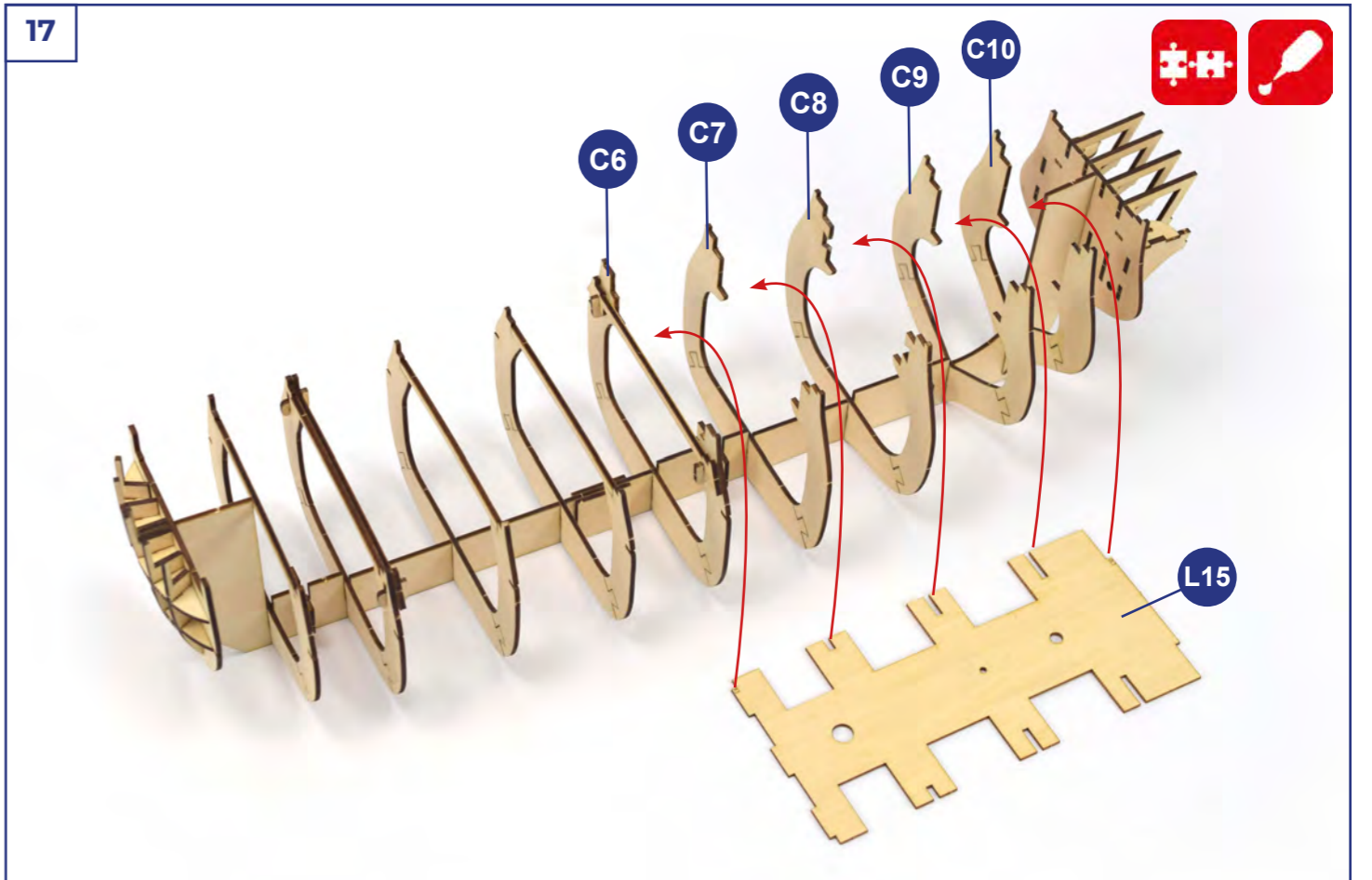

18

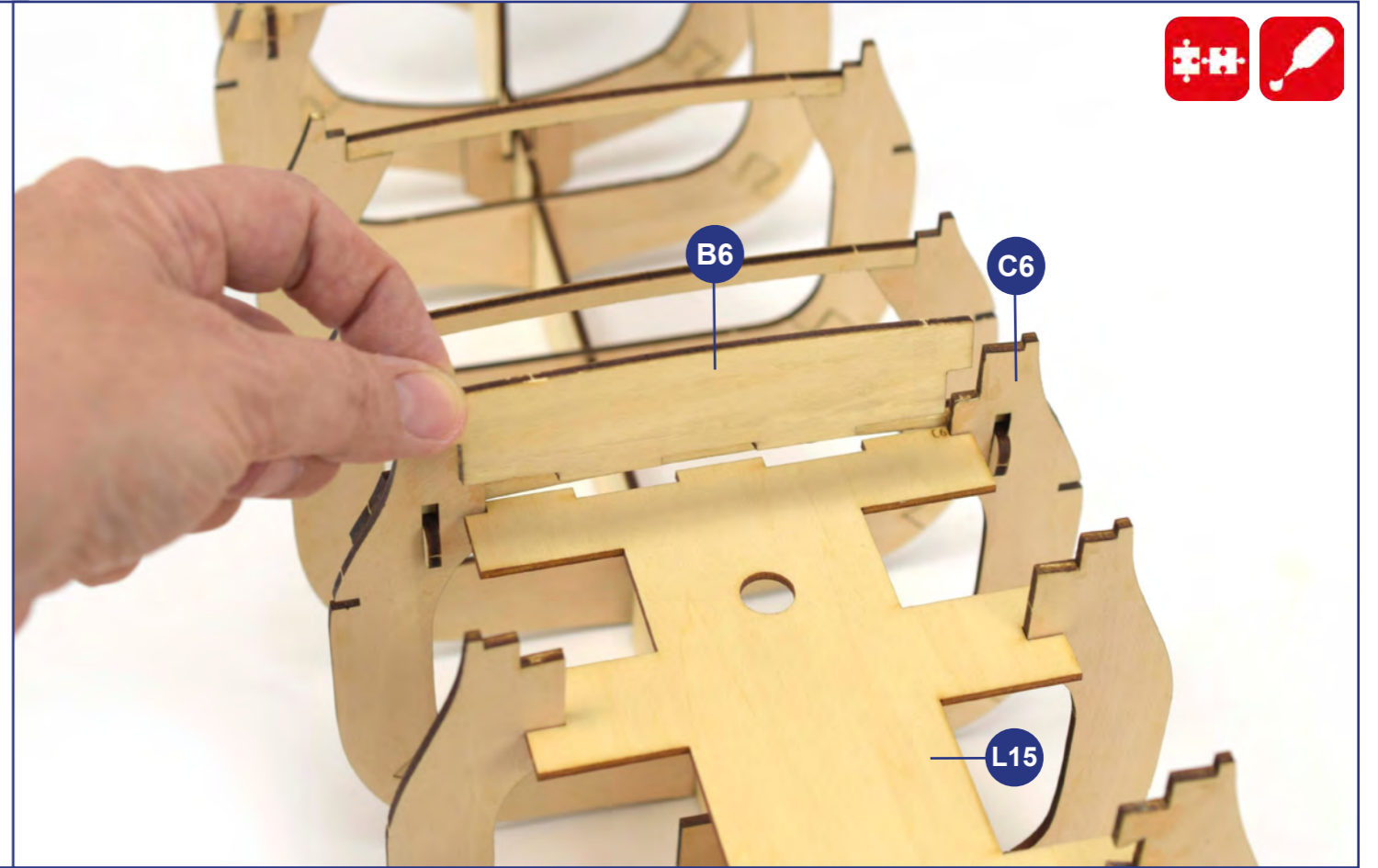
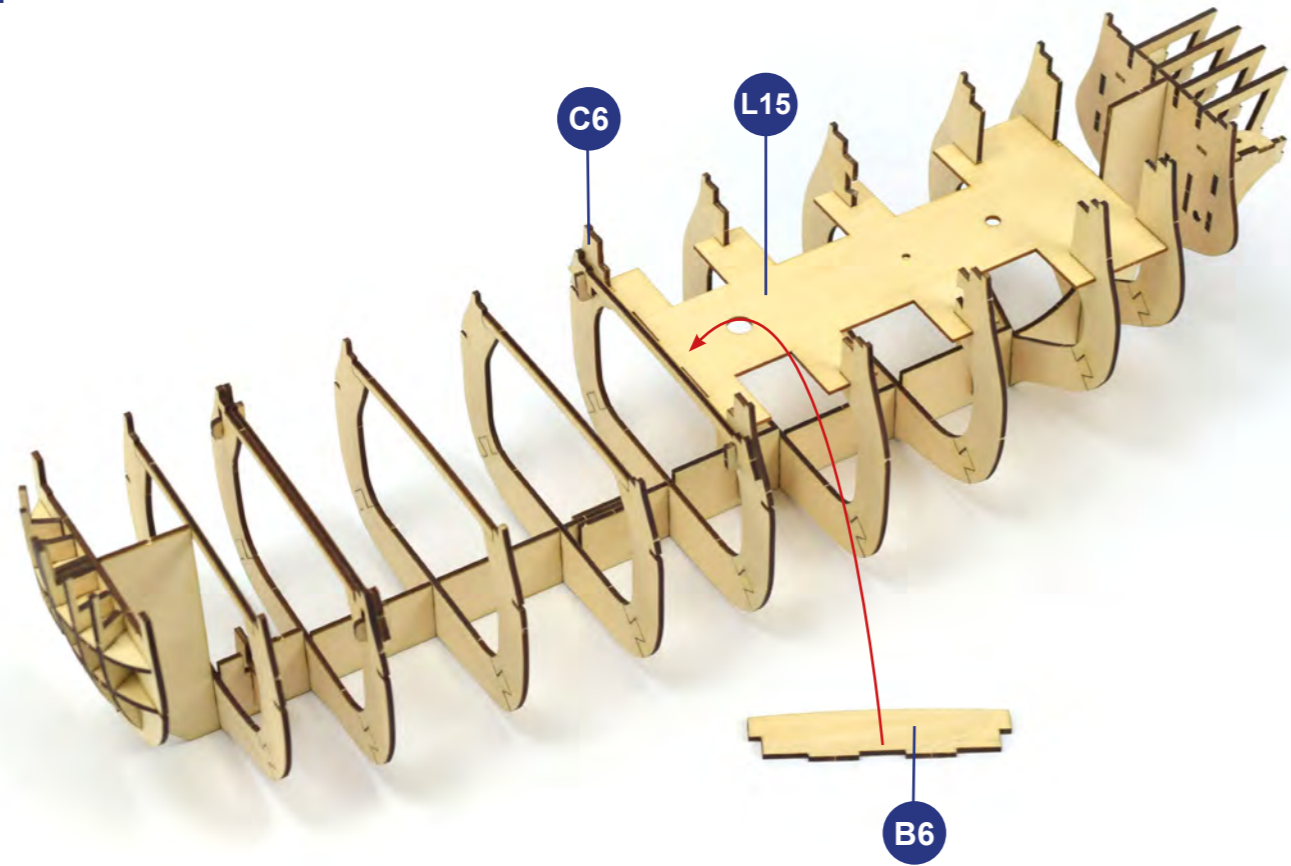

19

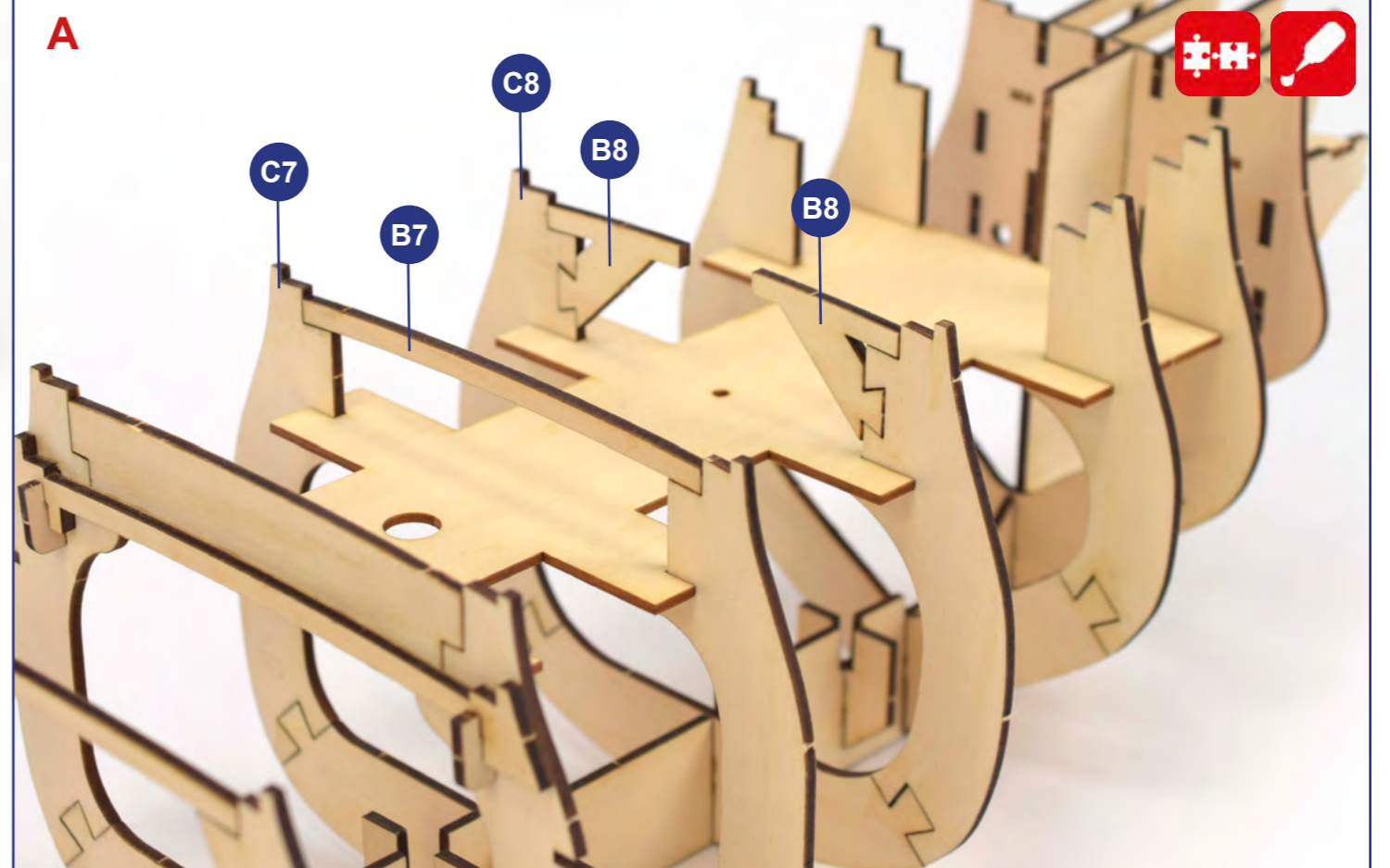
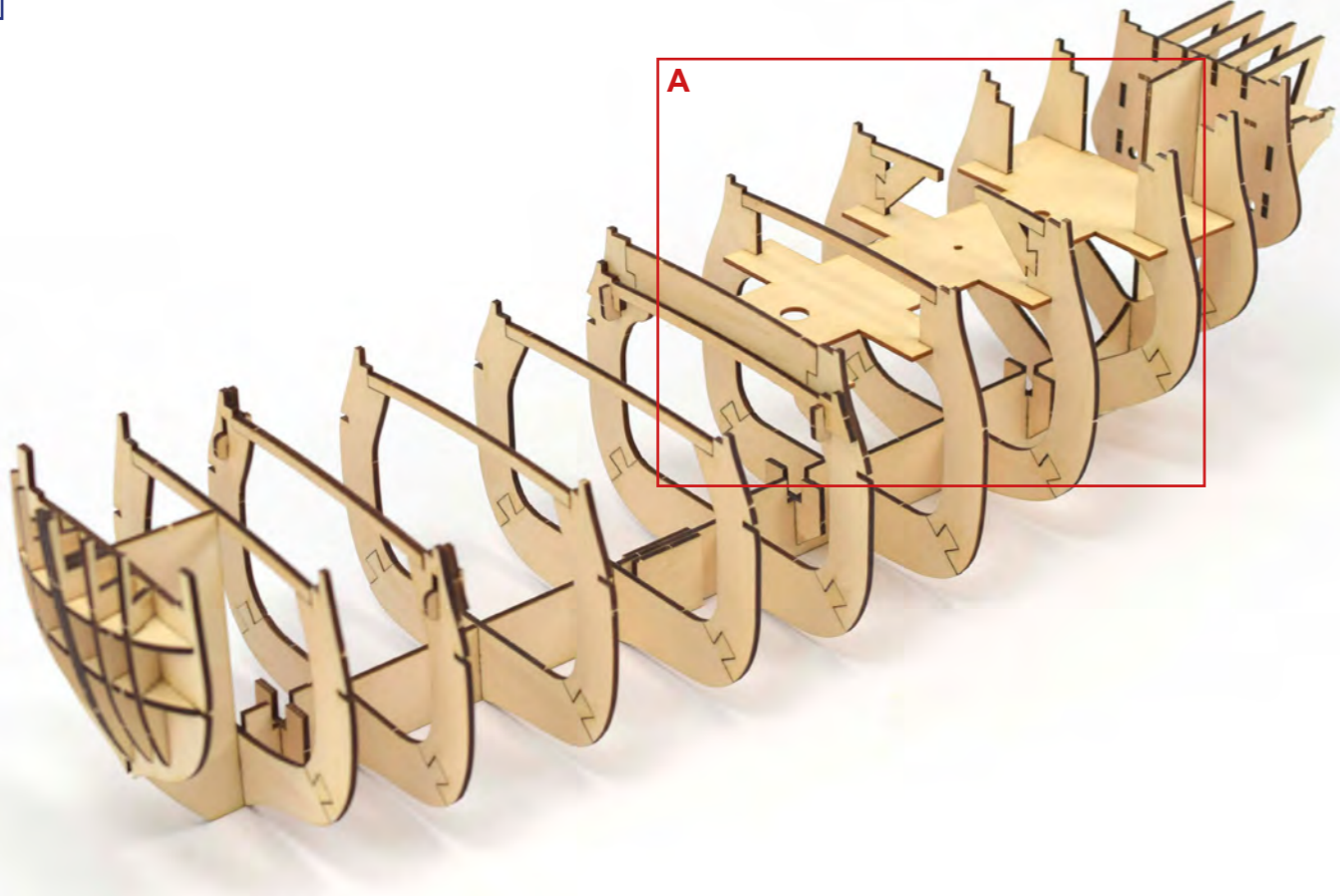

20

R

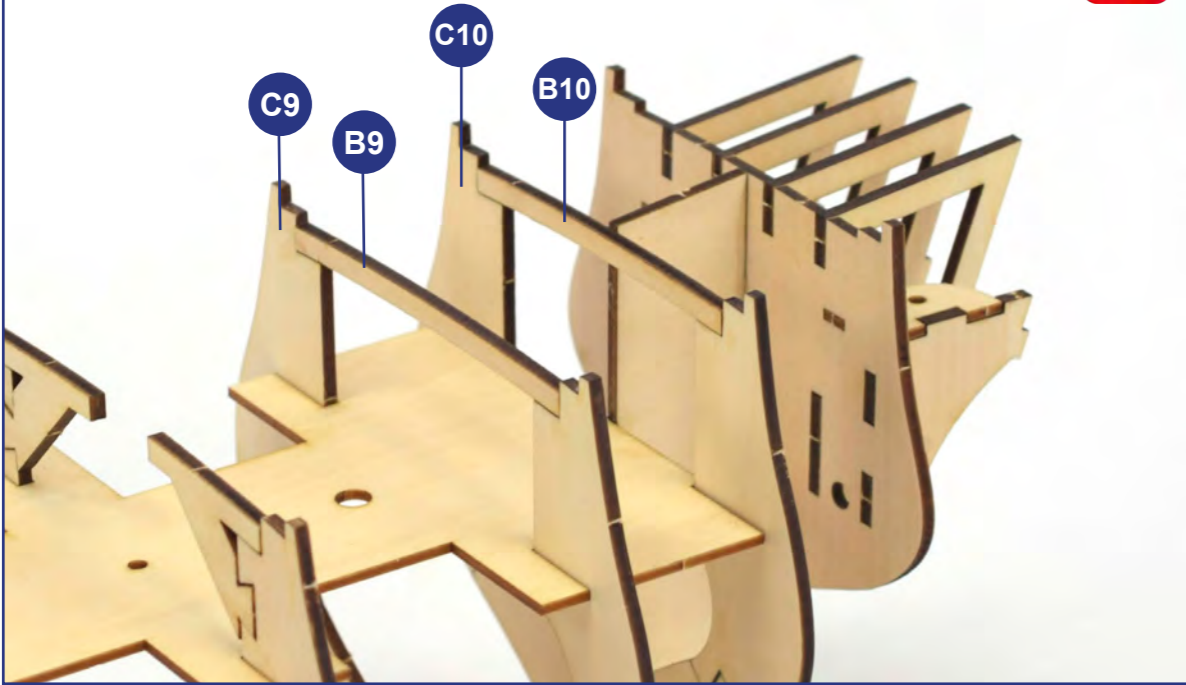

21

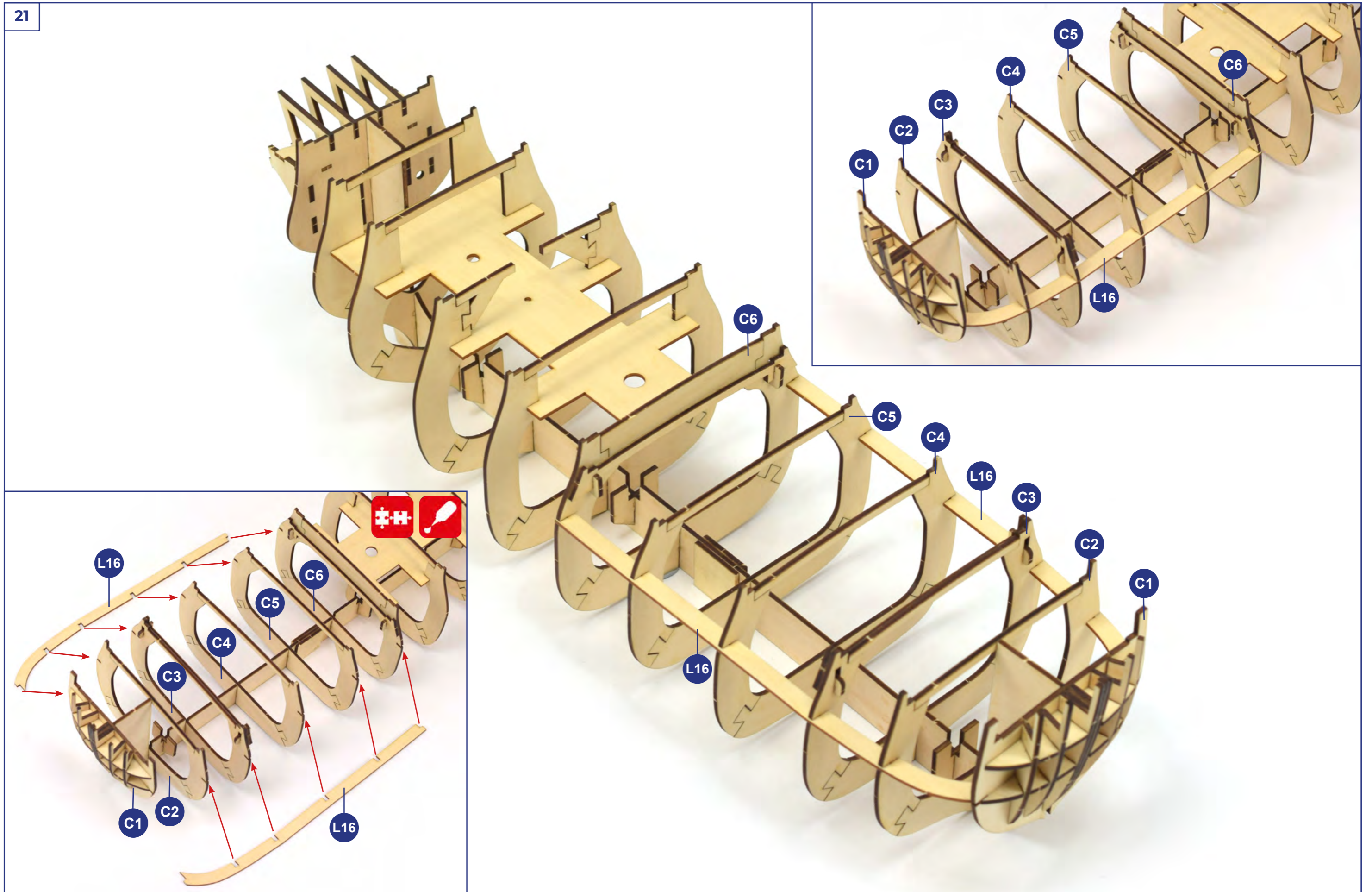

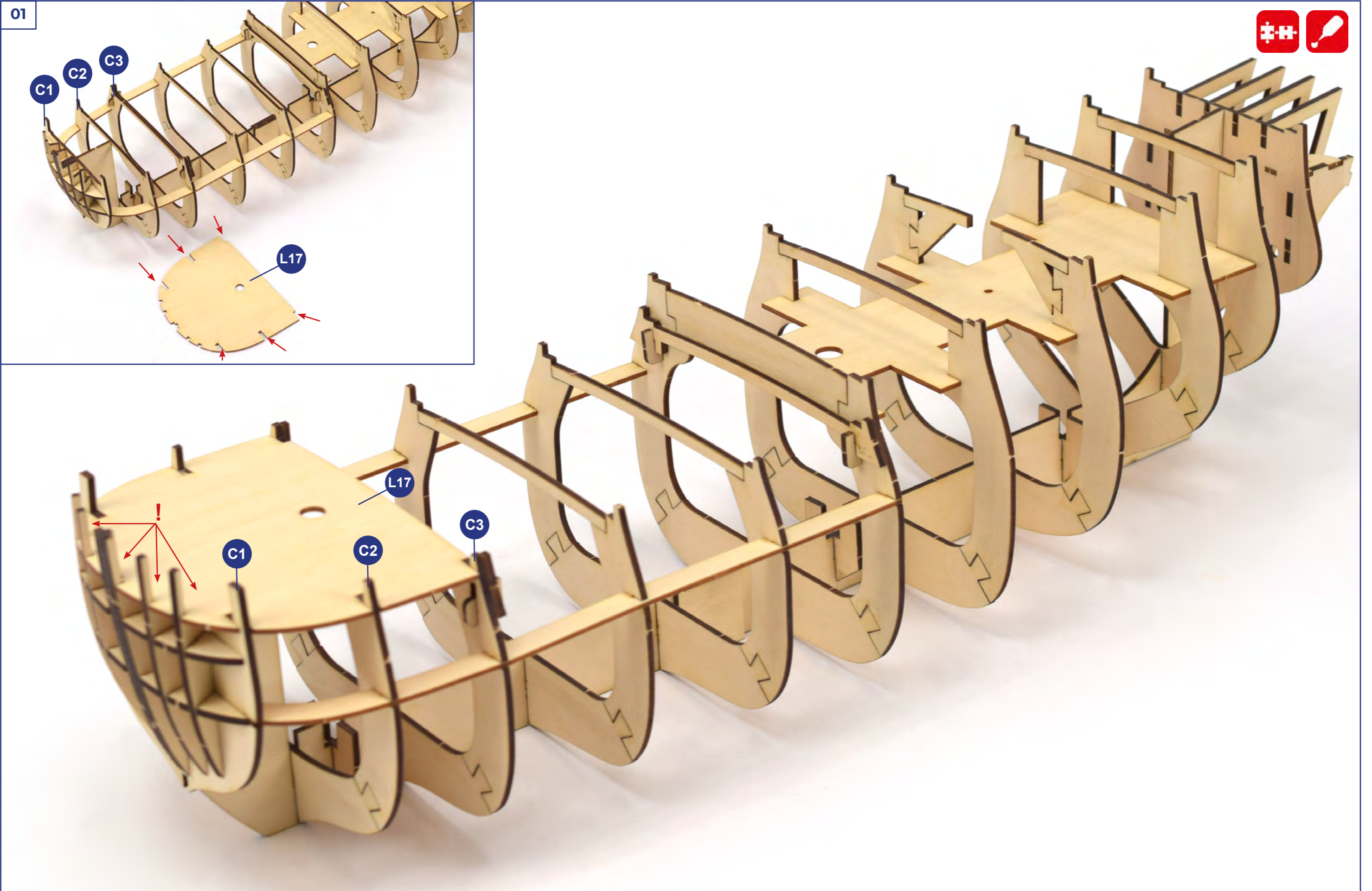

02

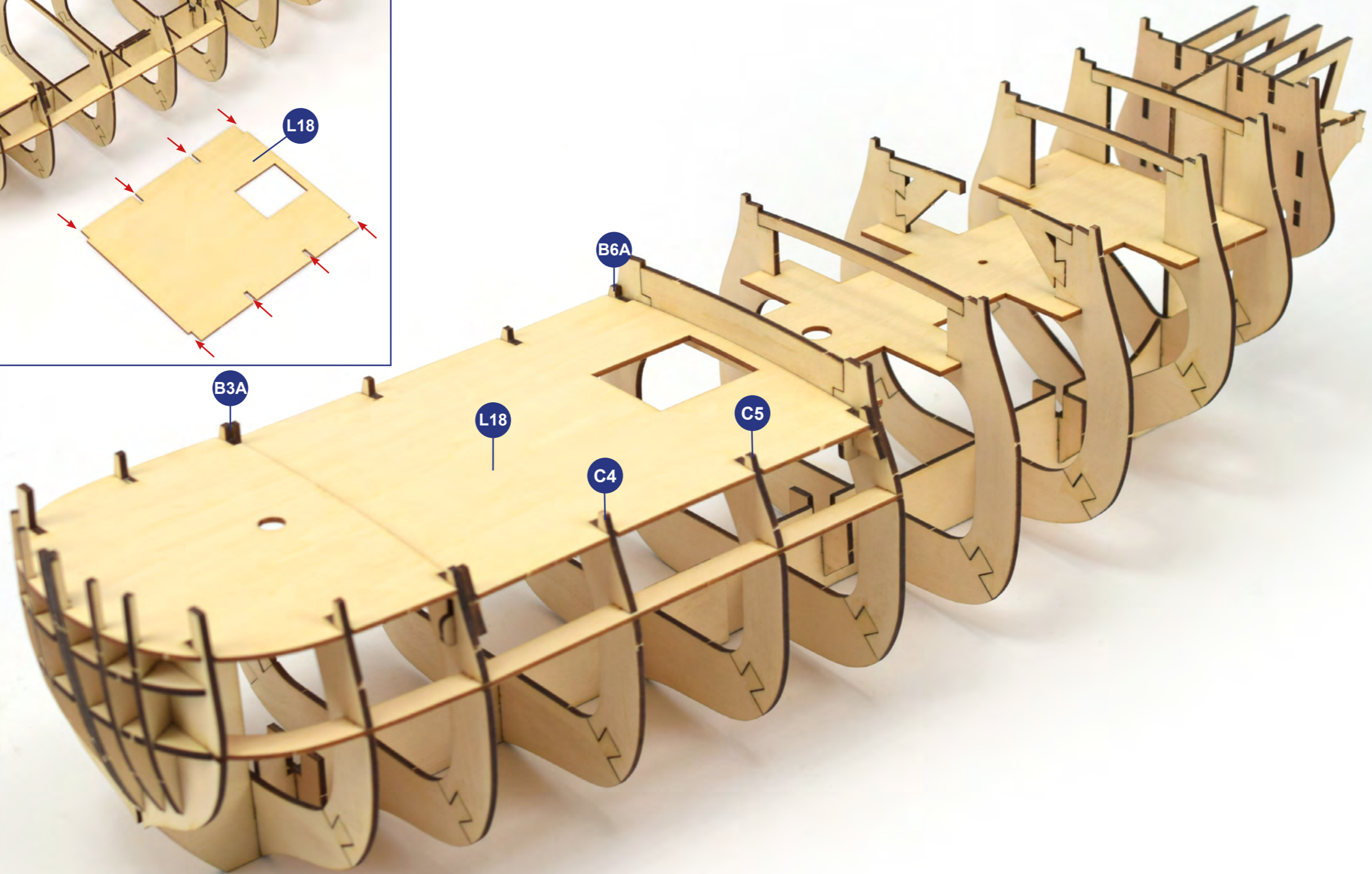
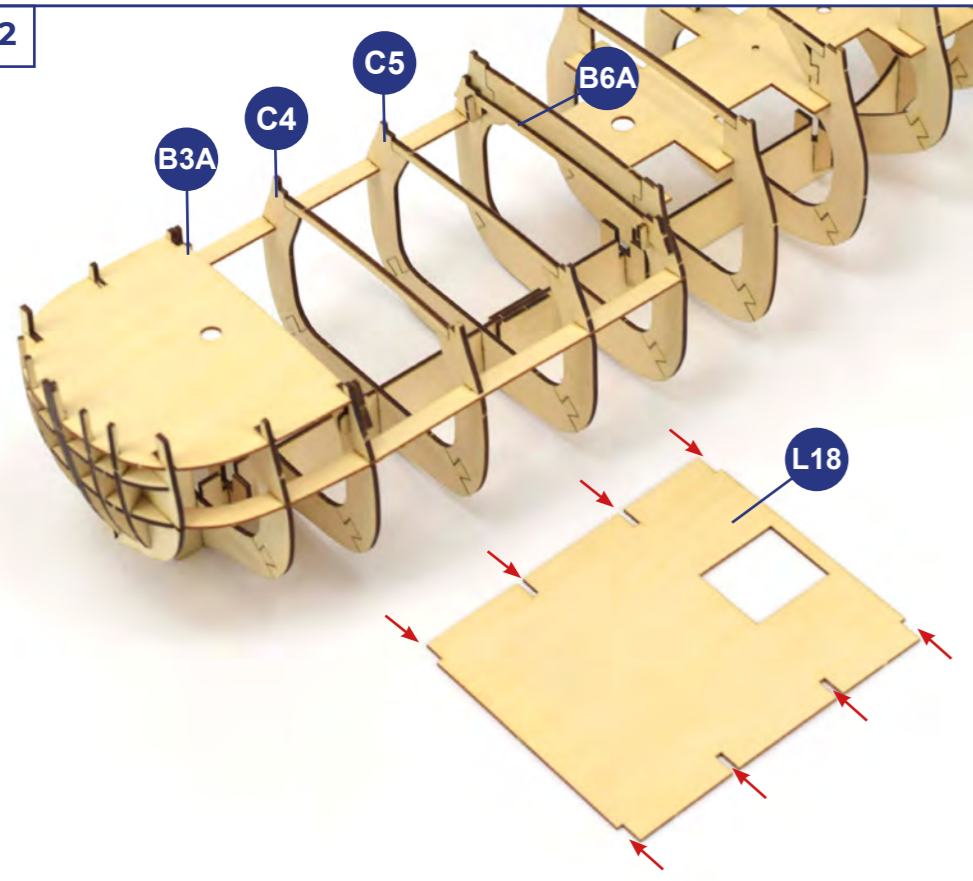

03

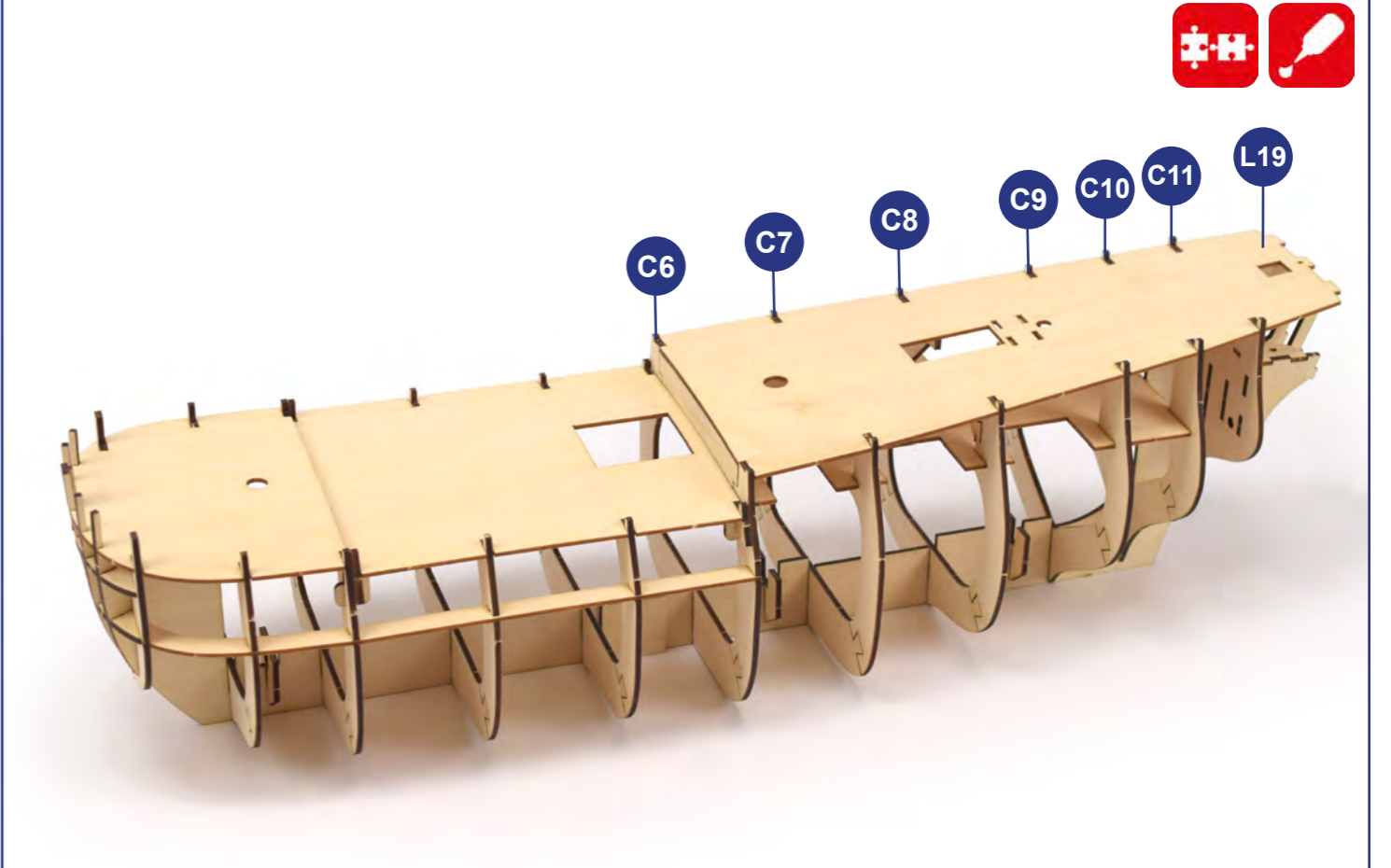
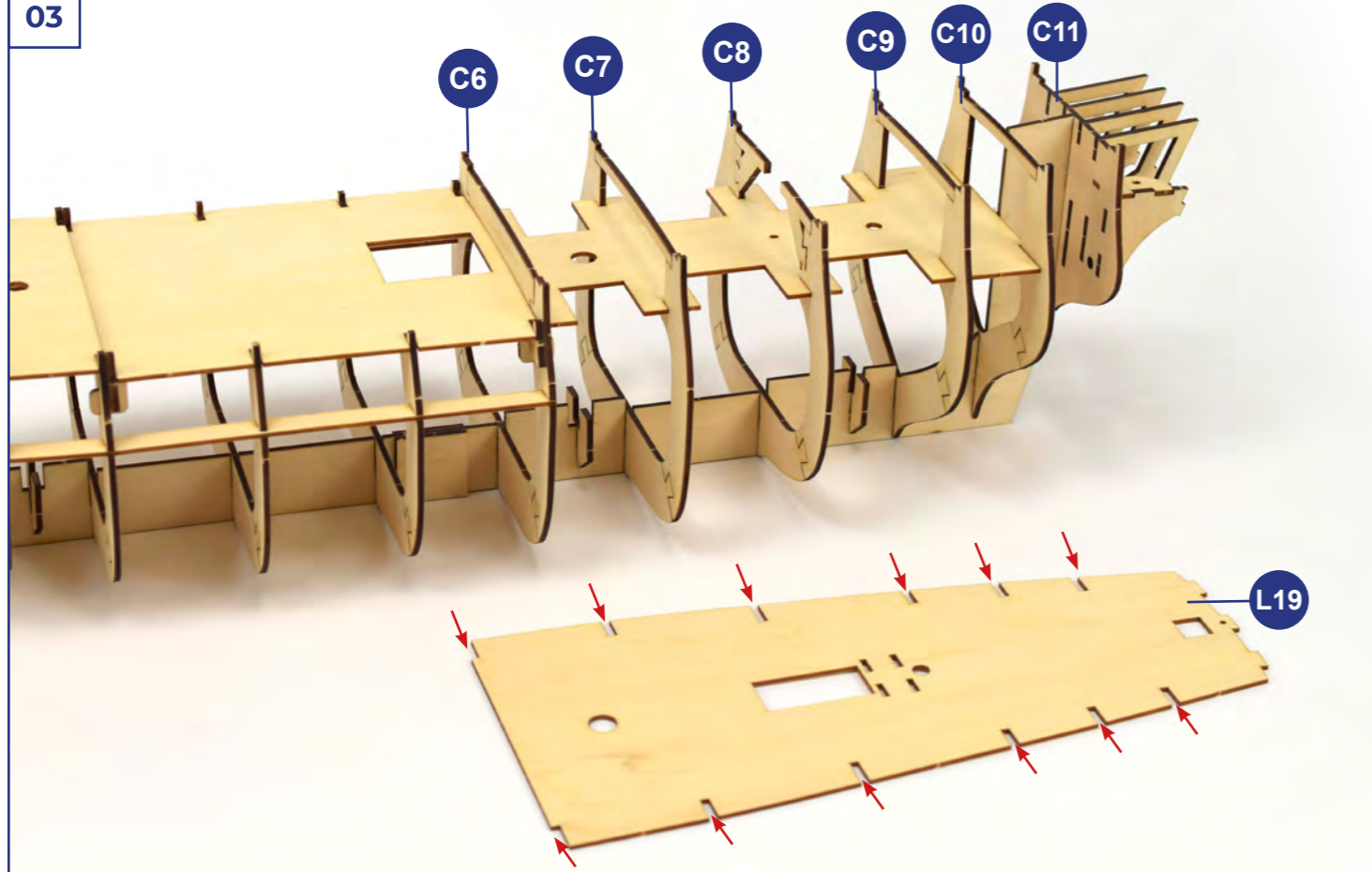

04

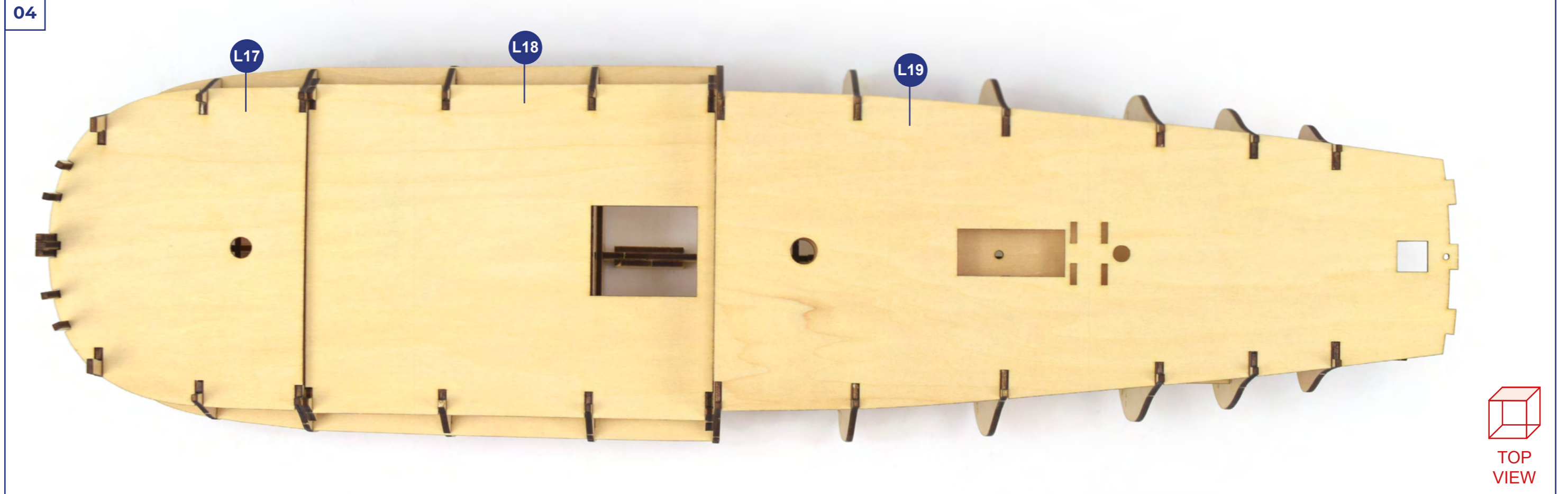

01

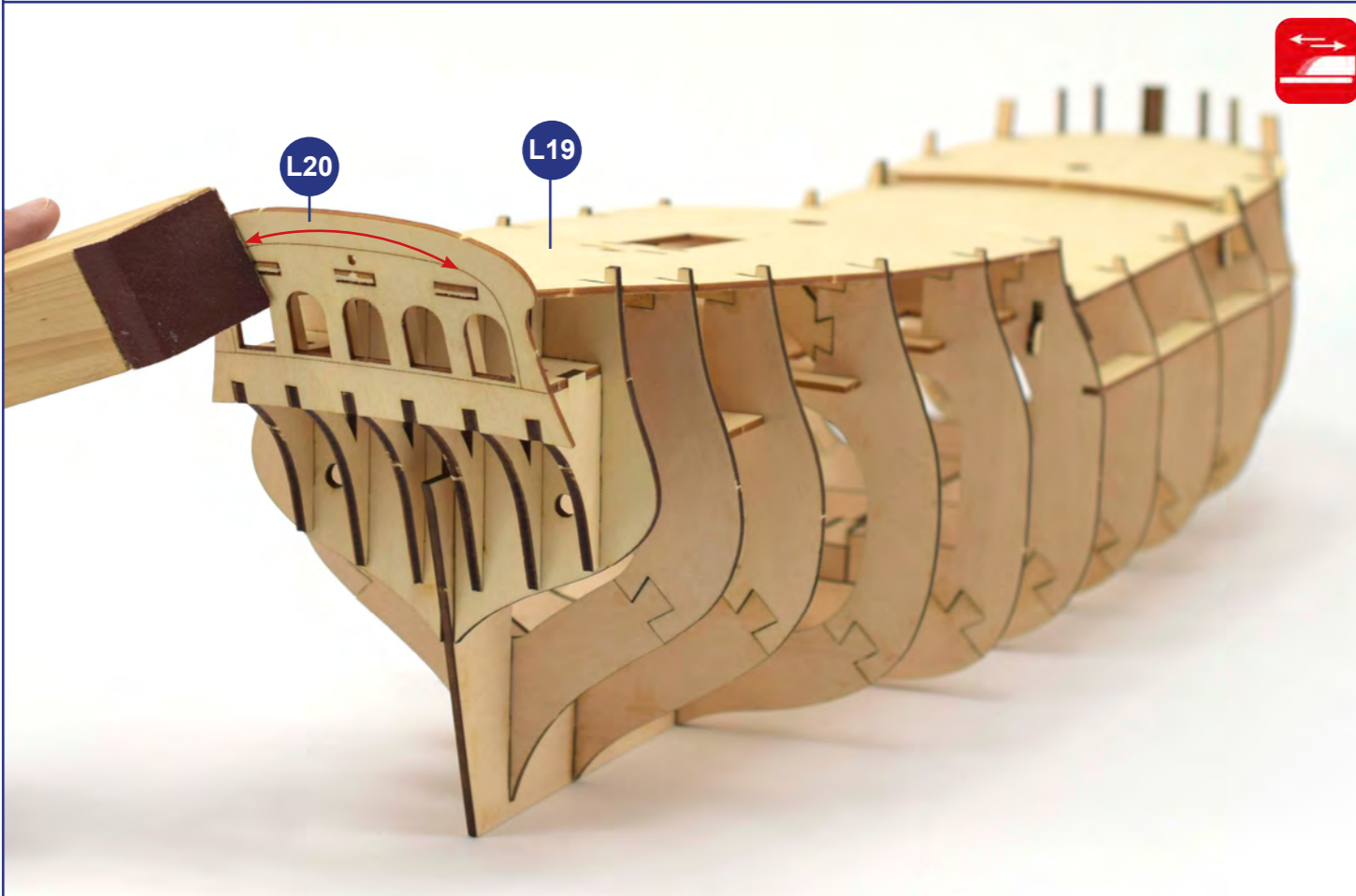
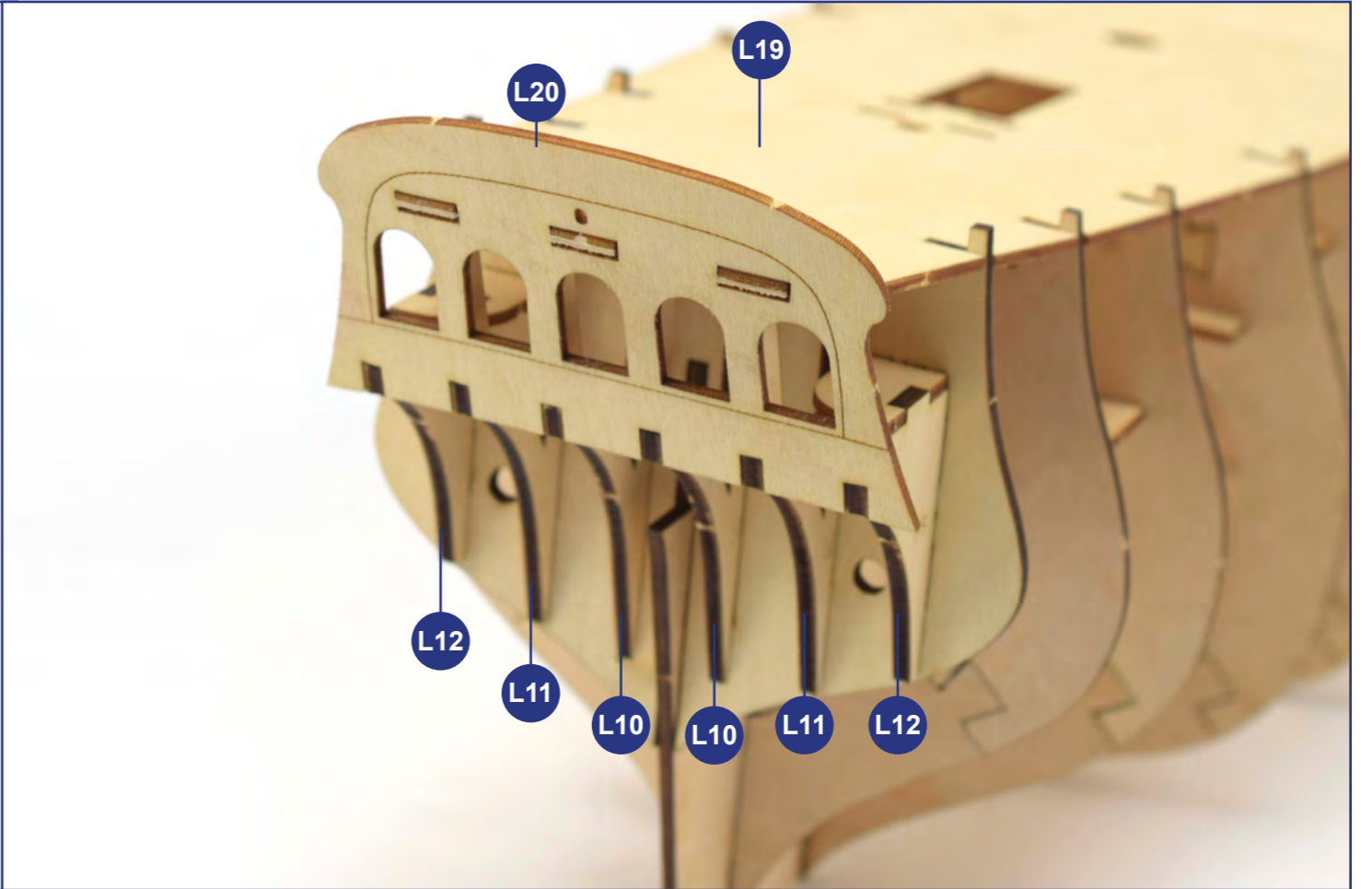
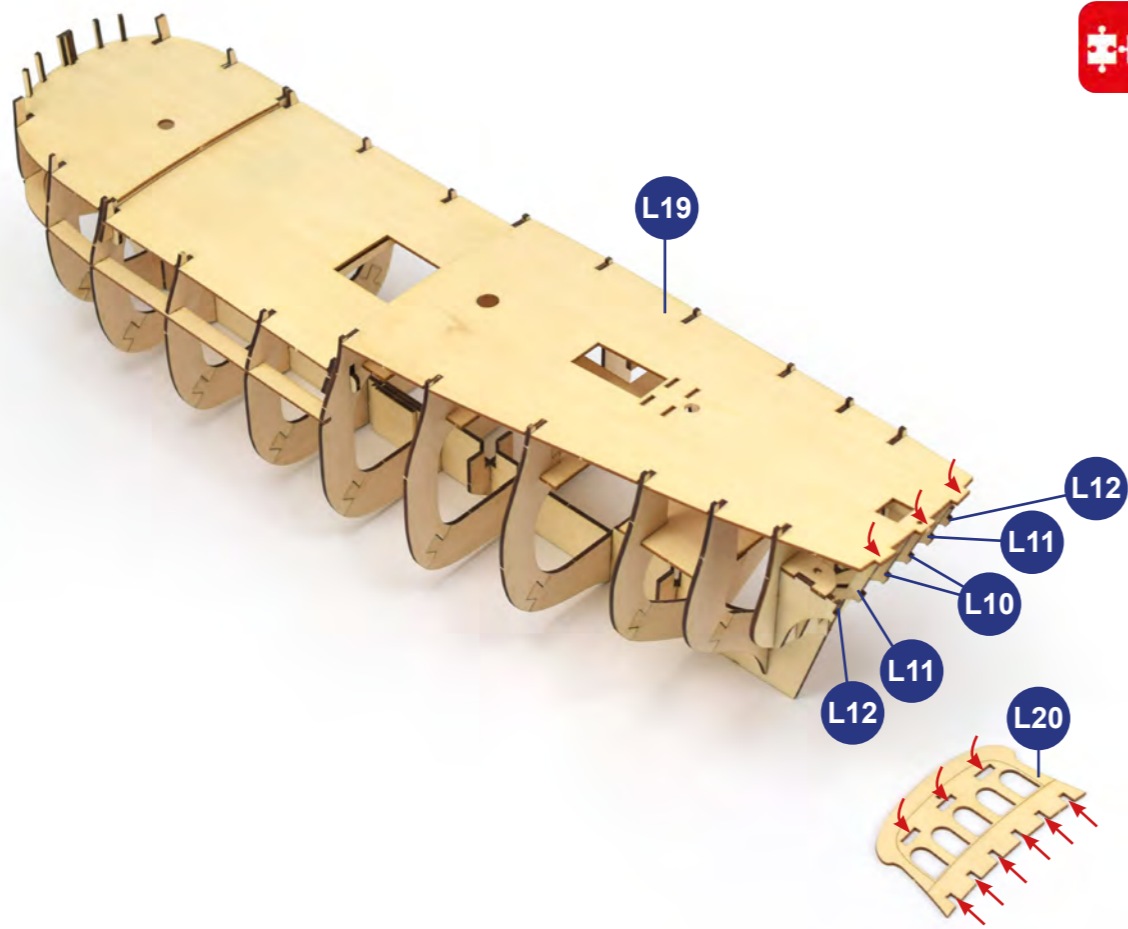

02



RIGHT
VIEW

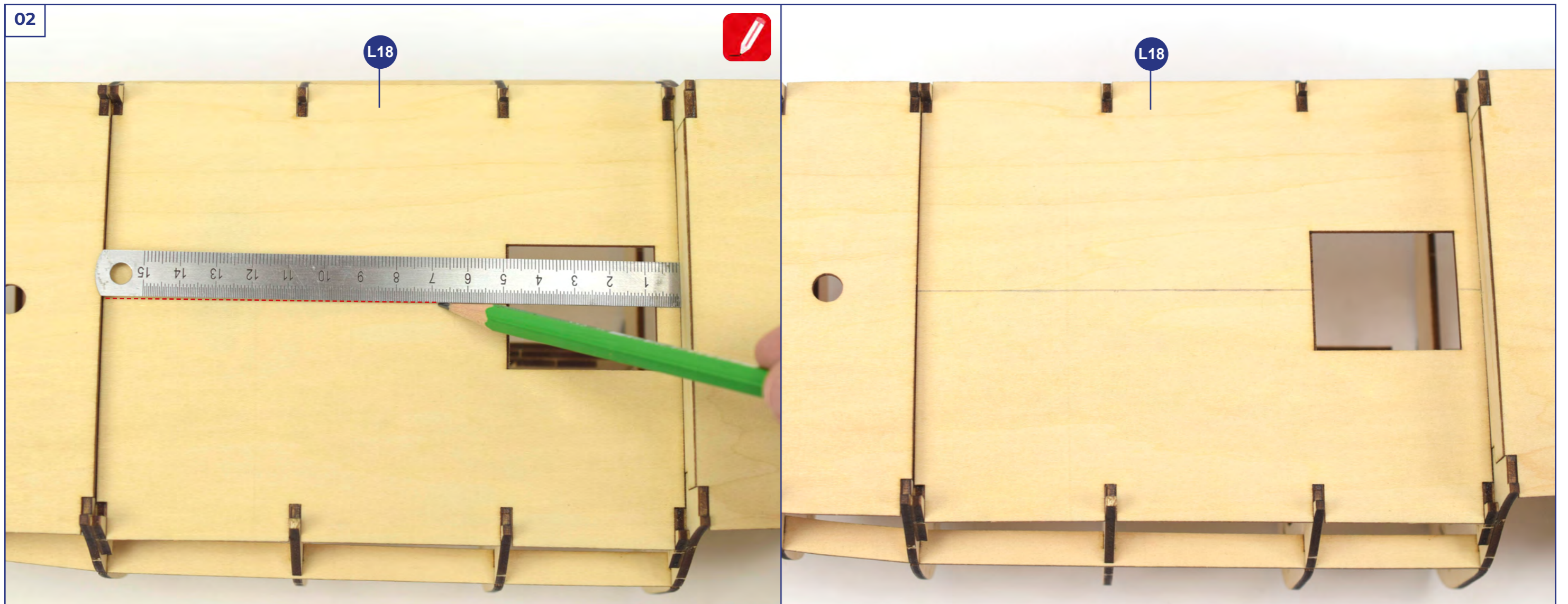
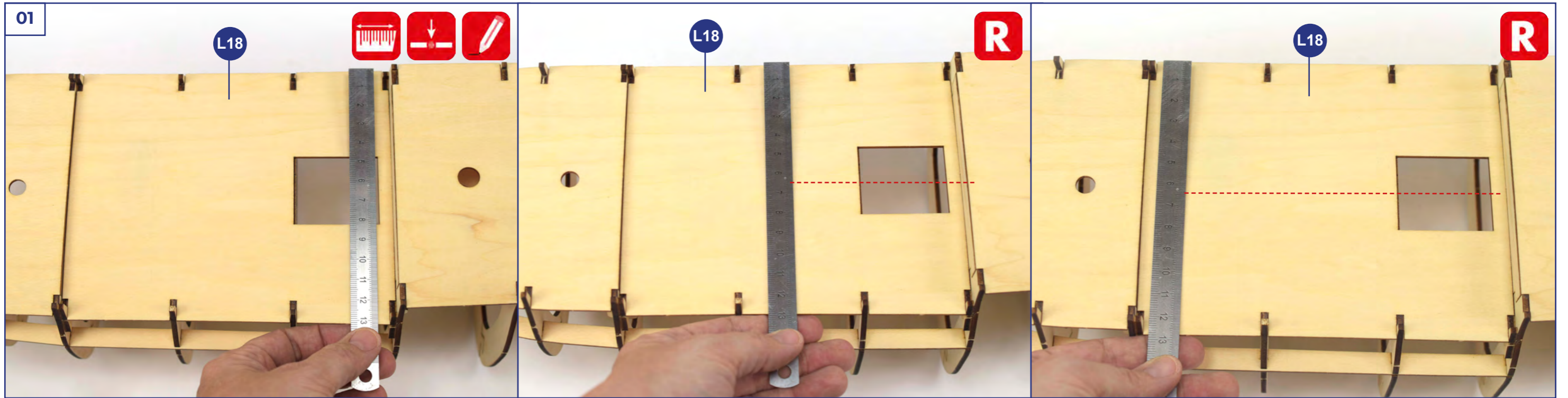

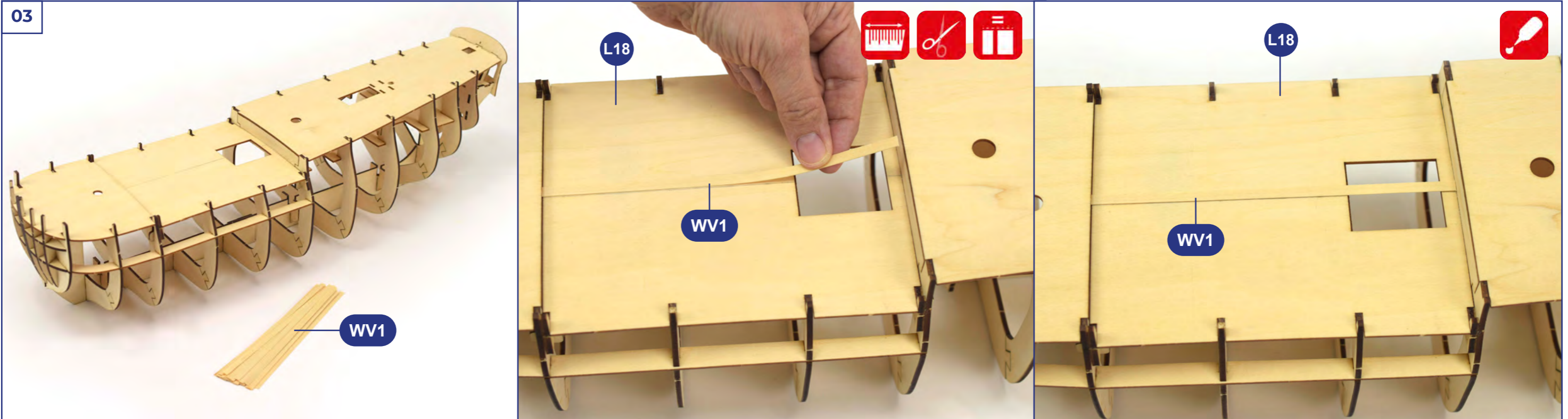

04

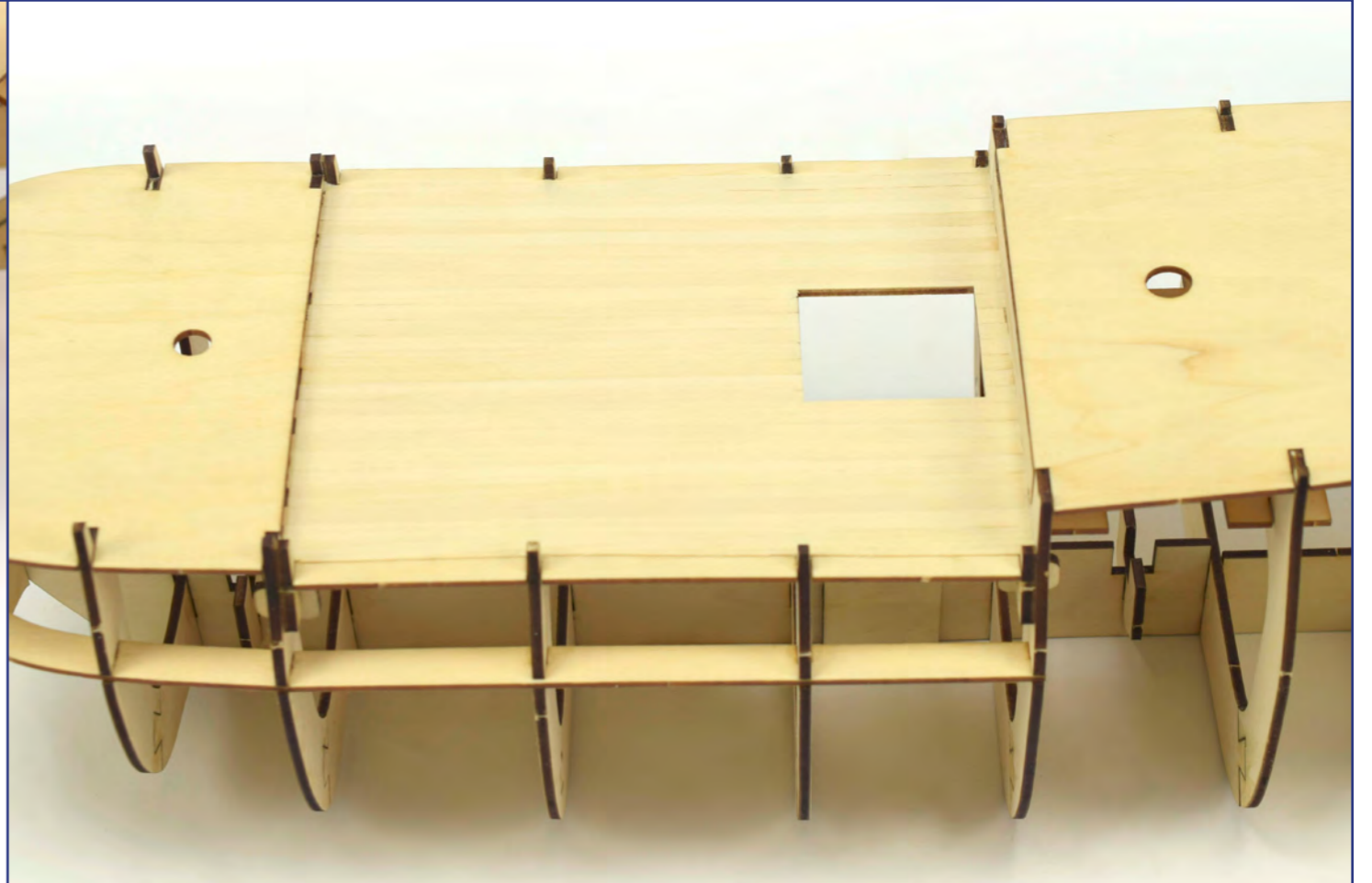
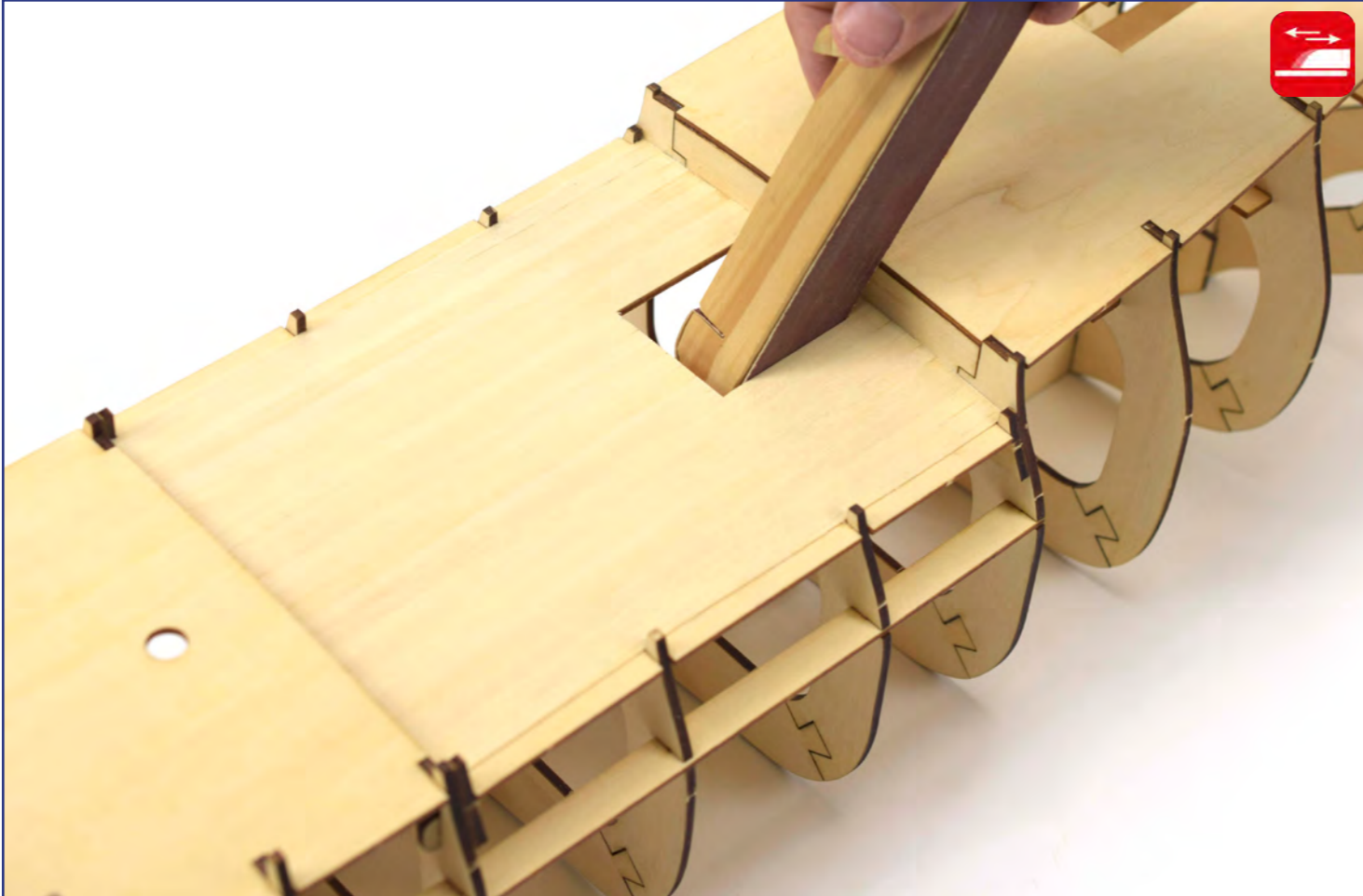
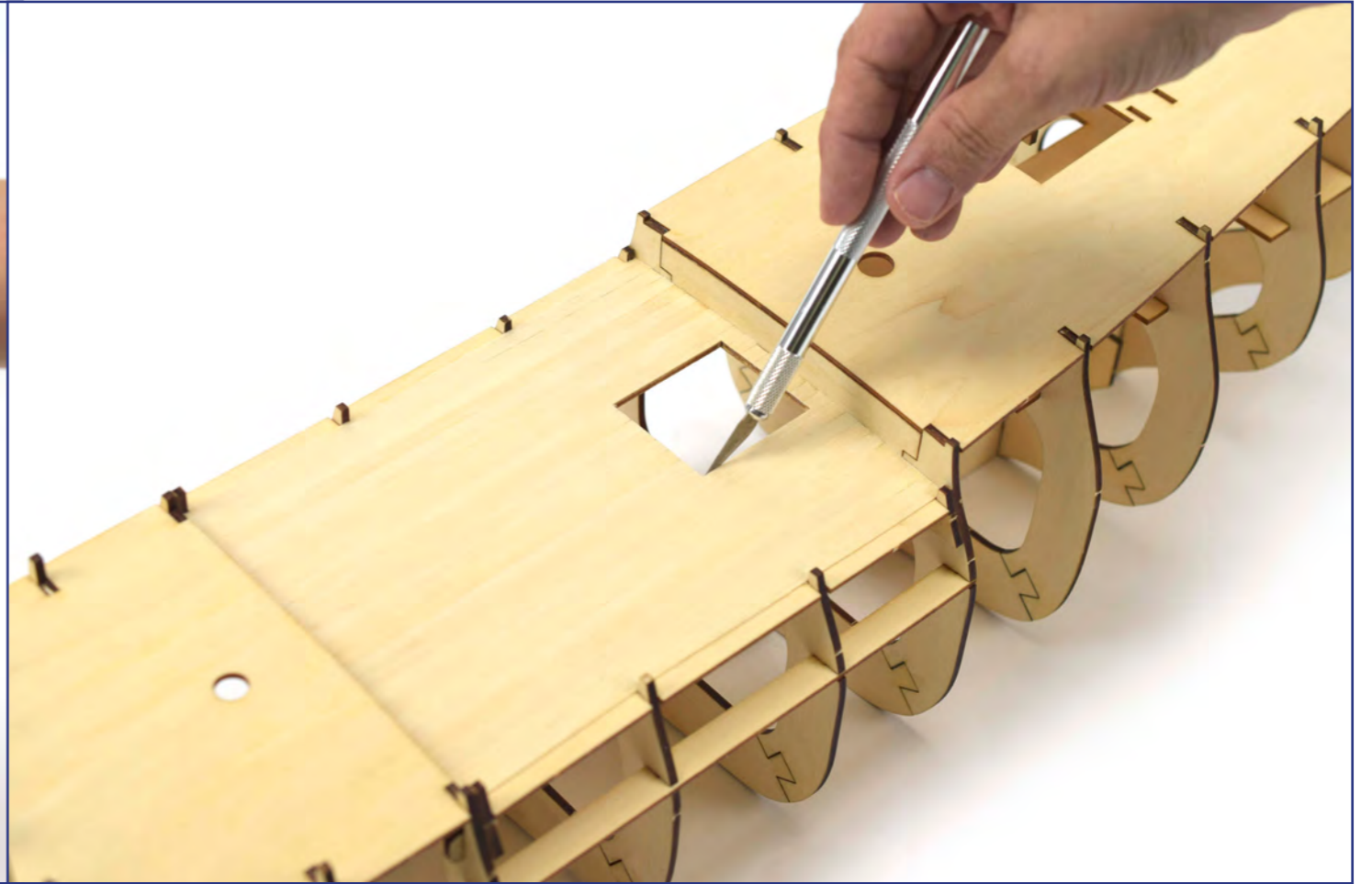
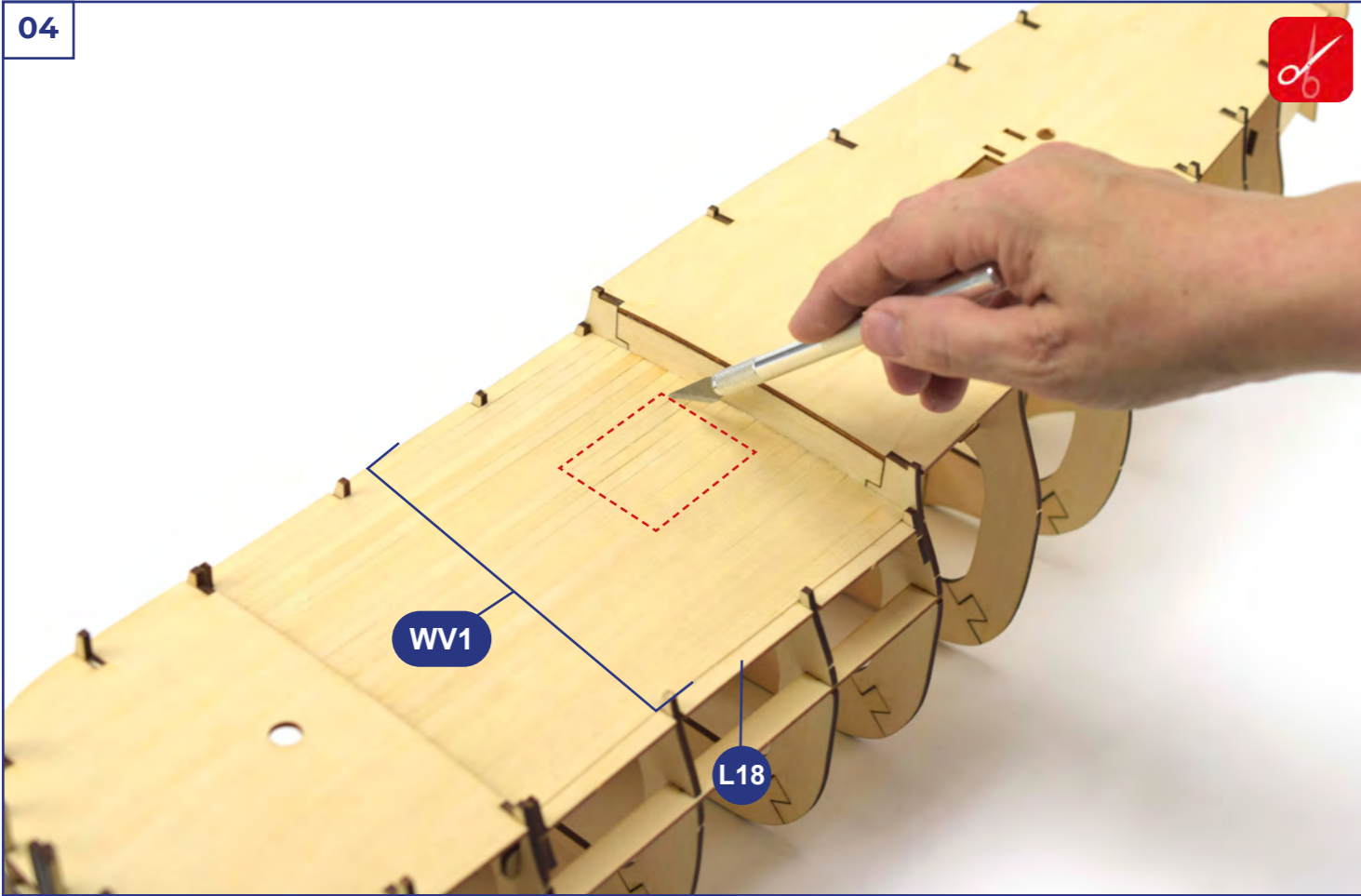

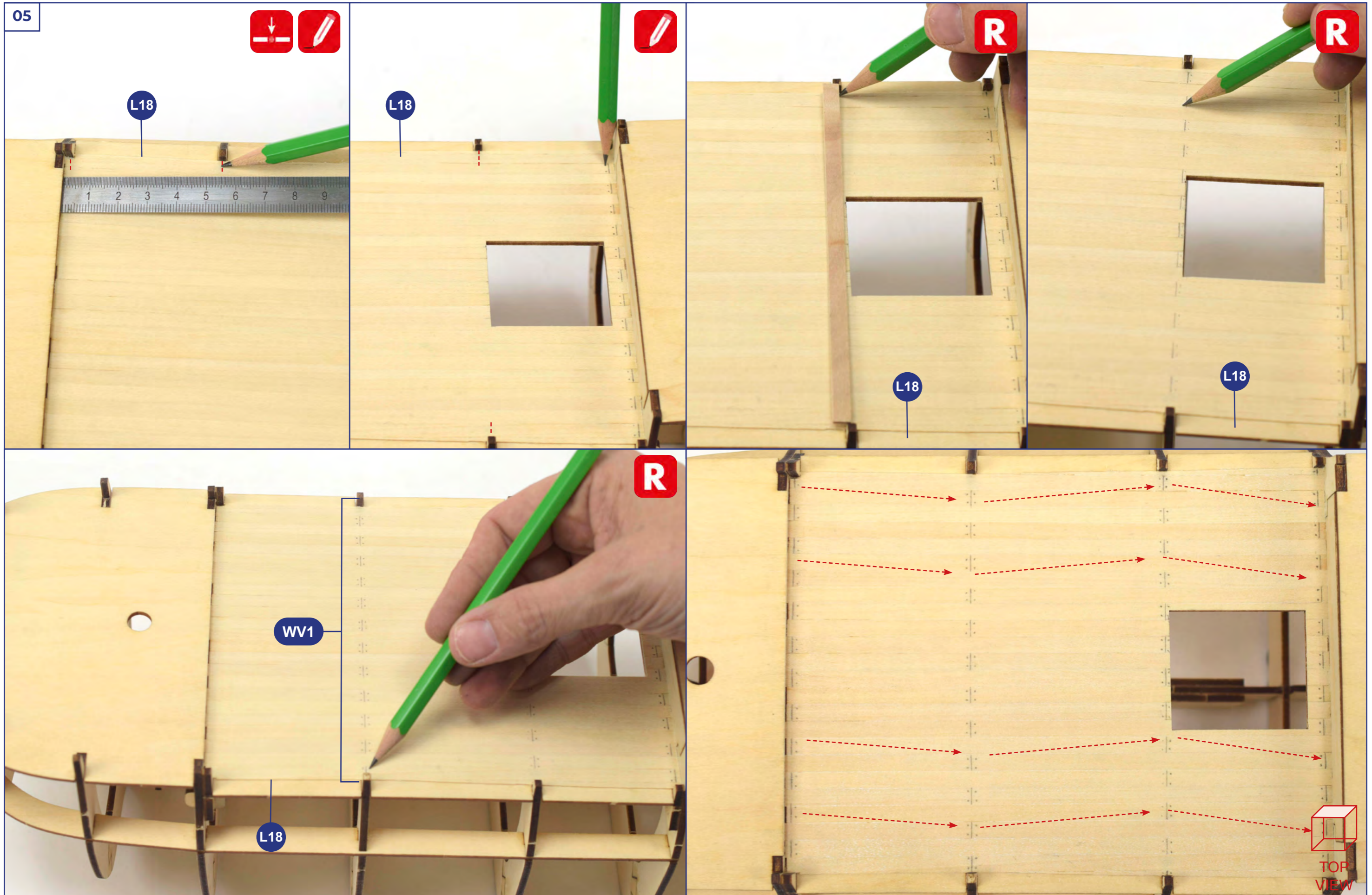

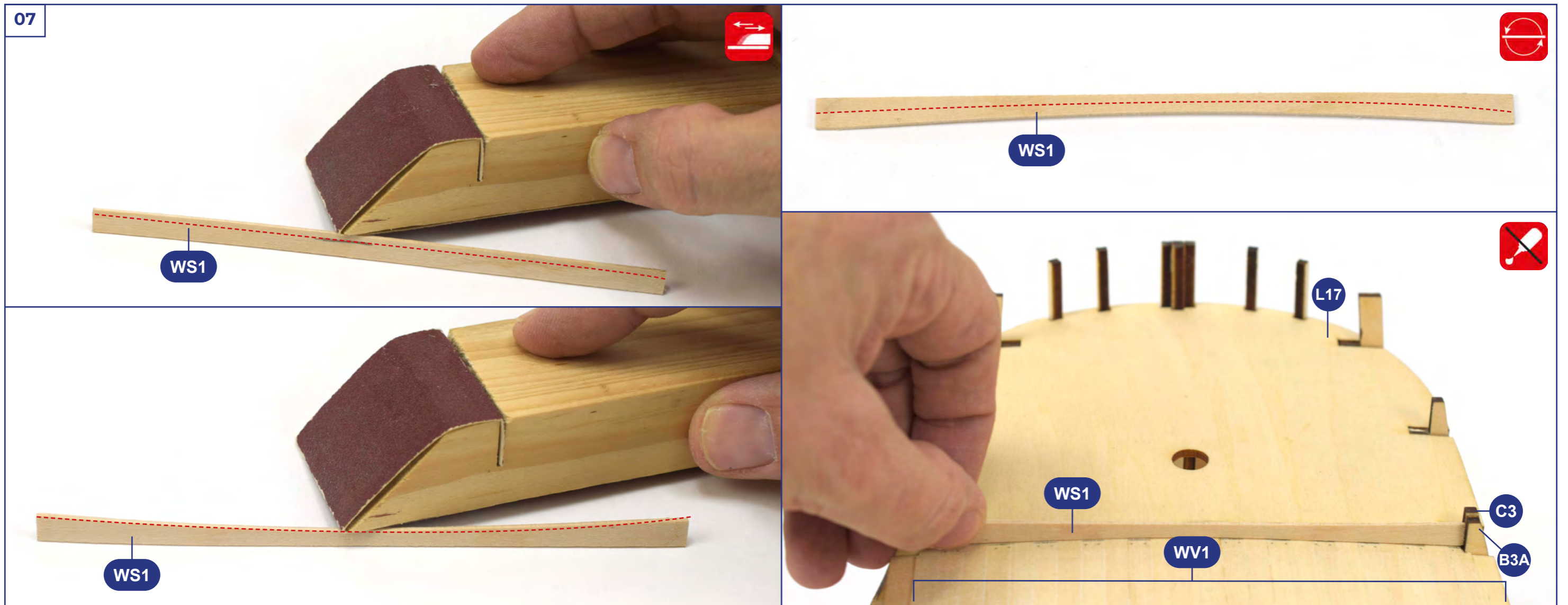
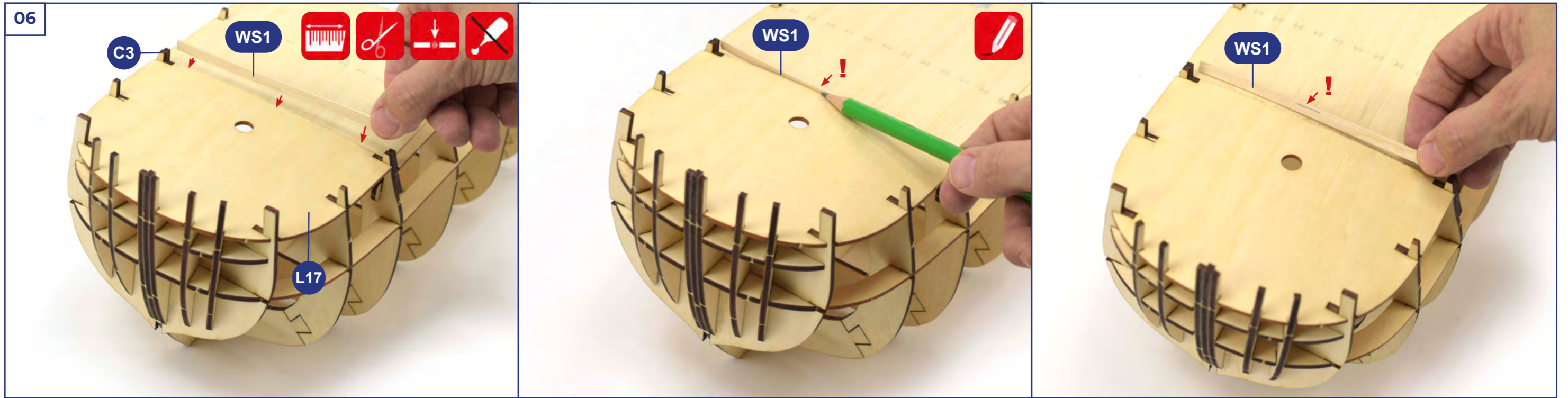

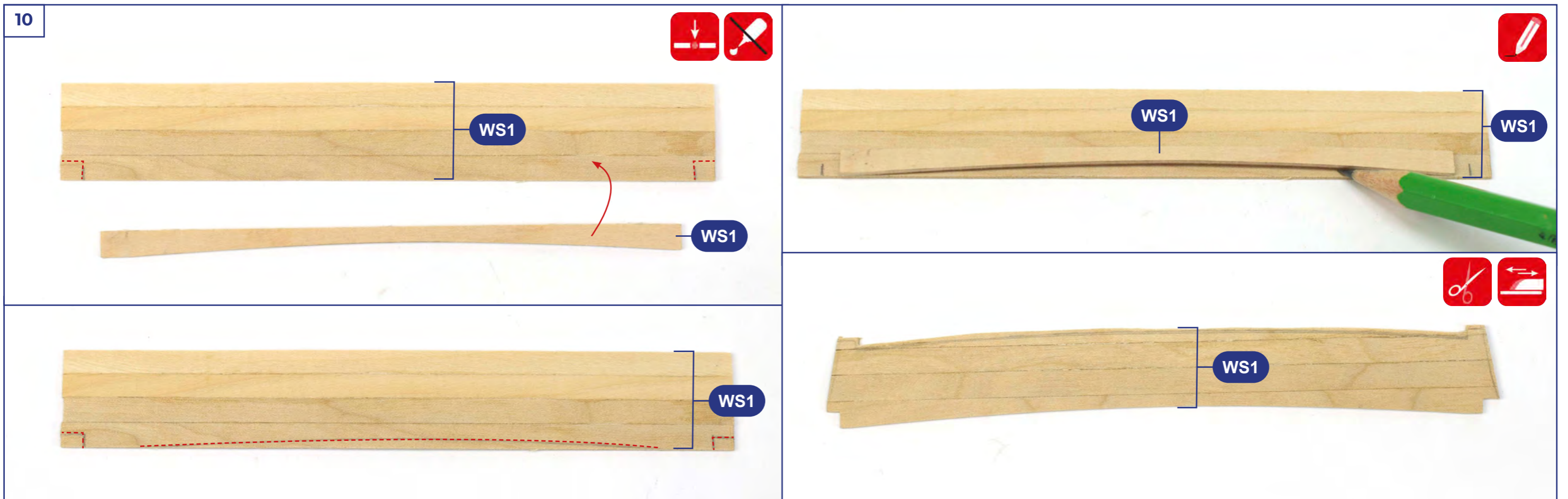
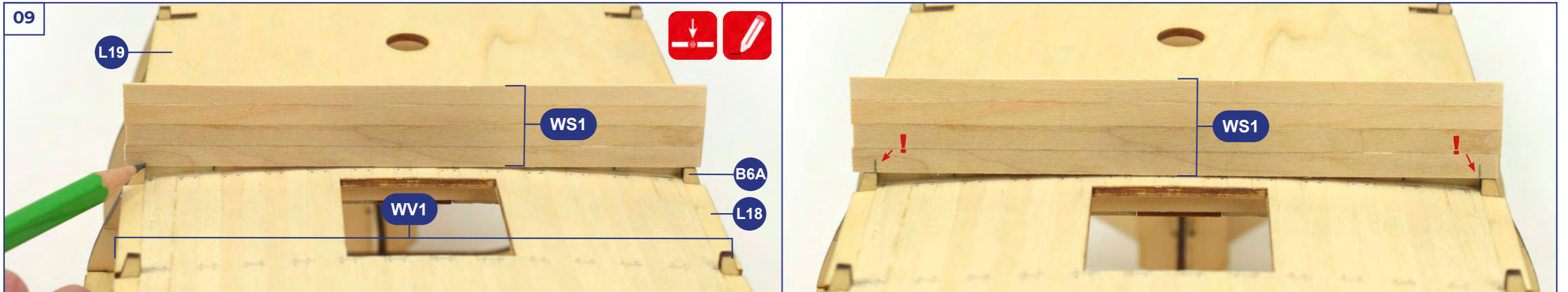
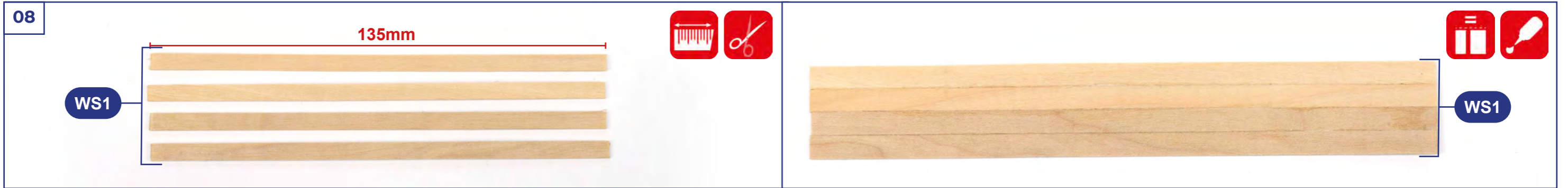

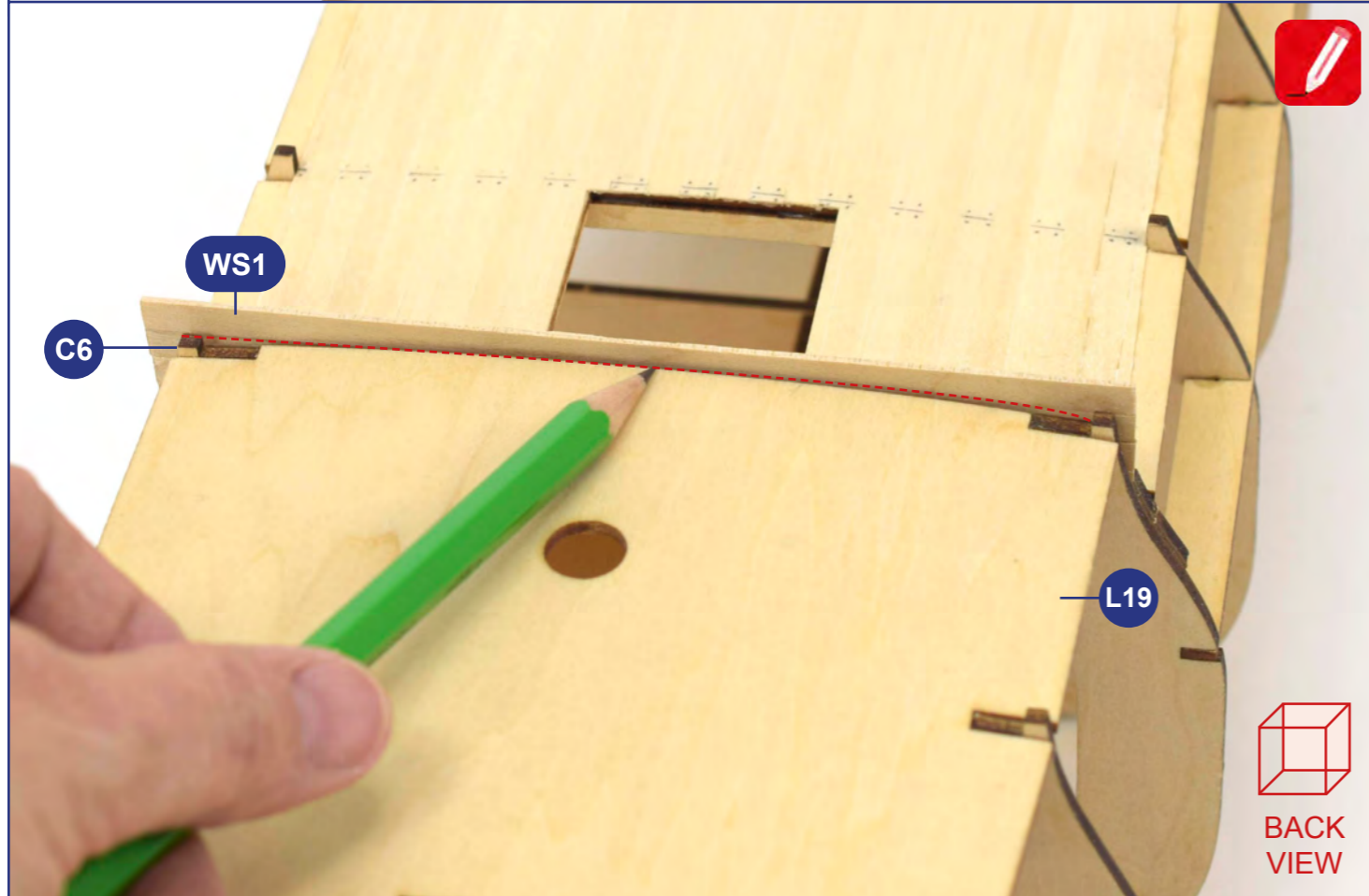

12

R

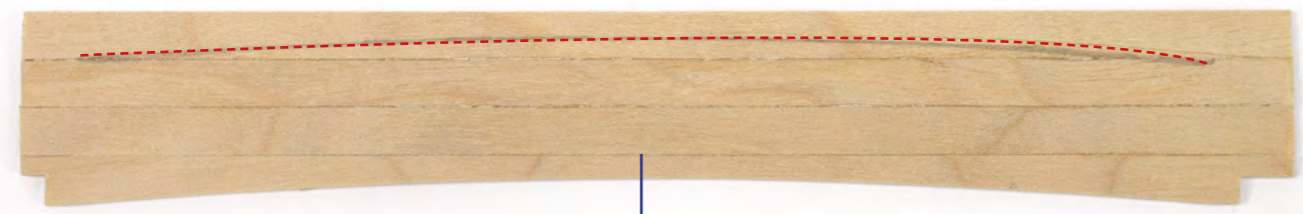

WS1

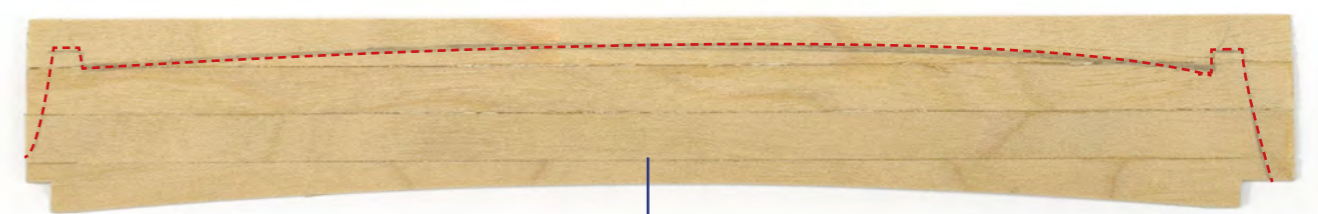

WS1



WS1



WS1



WS1

L19

B6A

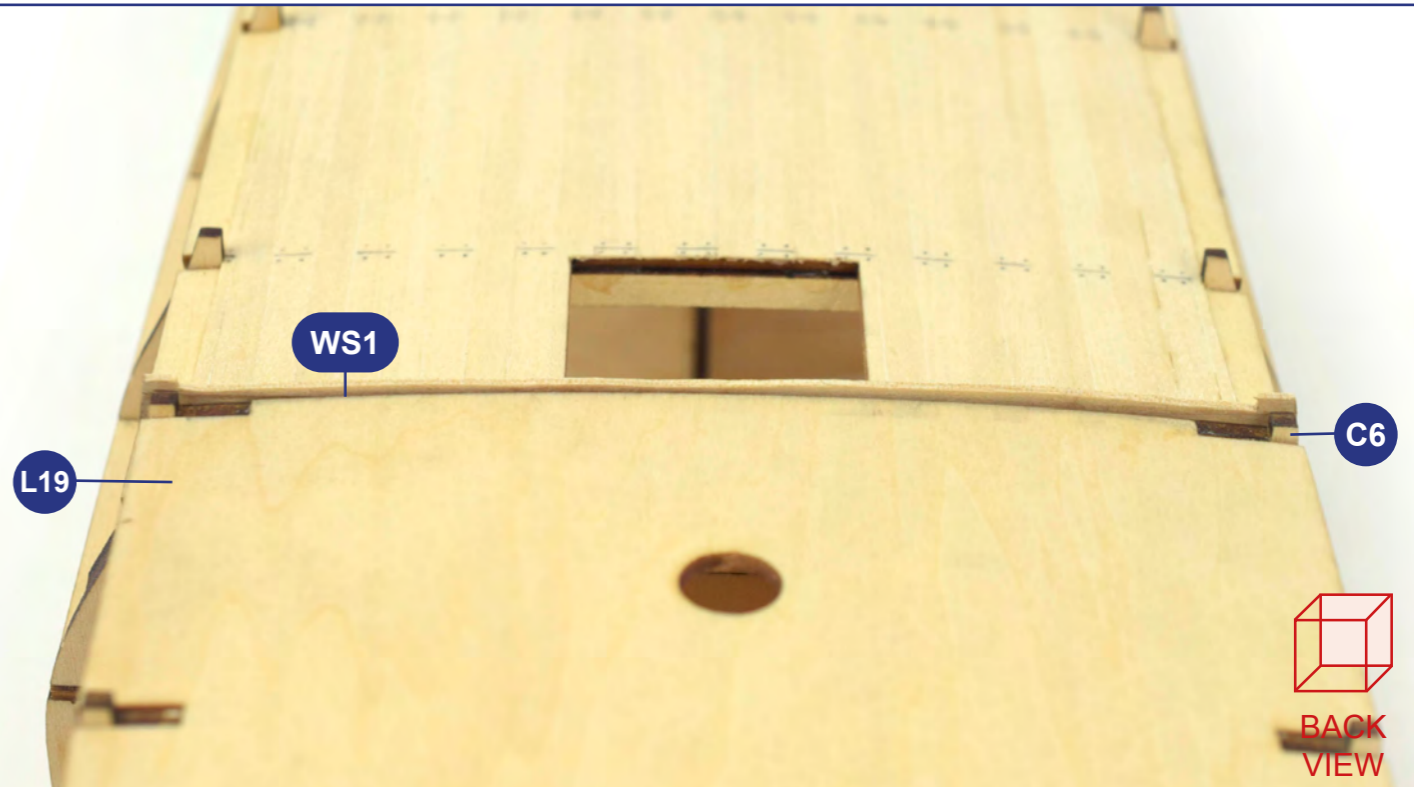

WS1

L19

C6

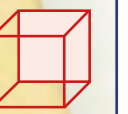

BACK VIEW

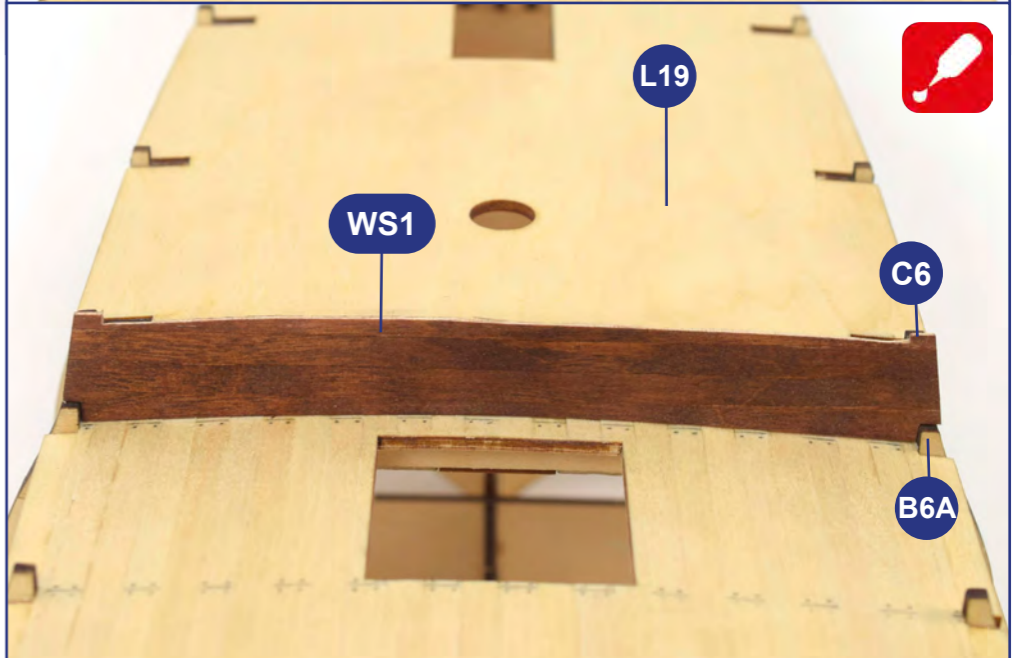
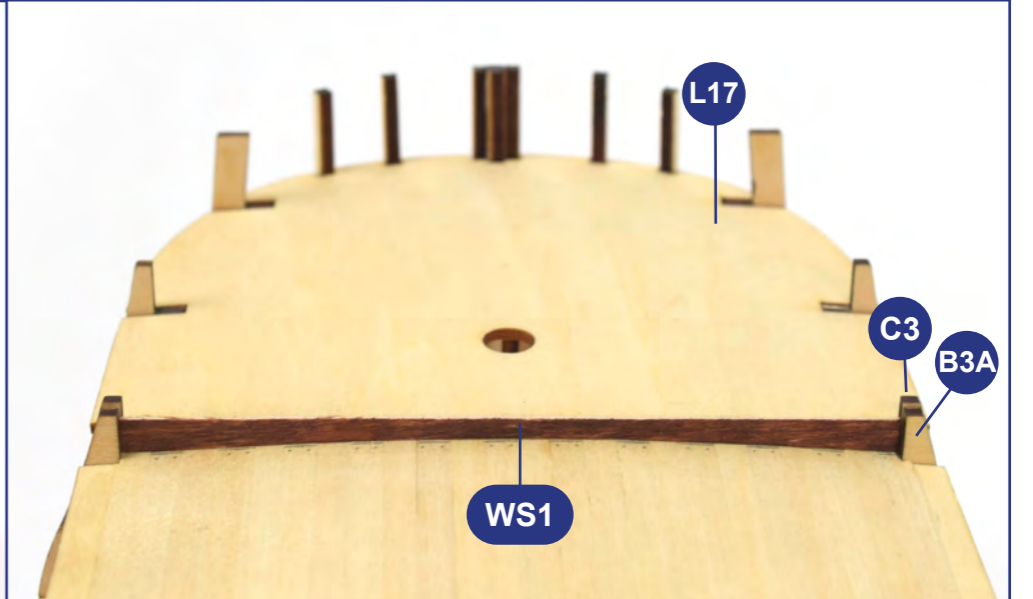
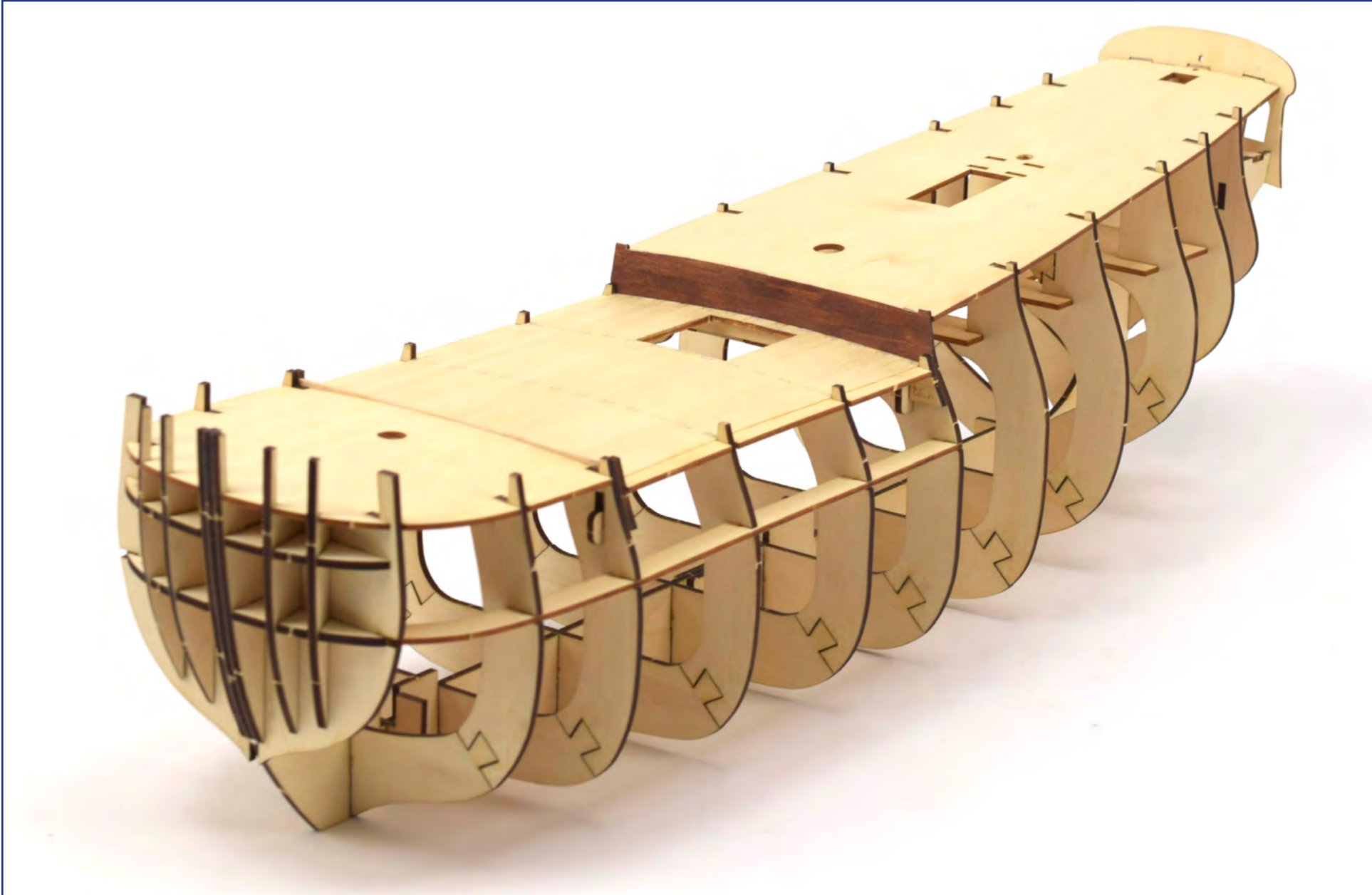
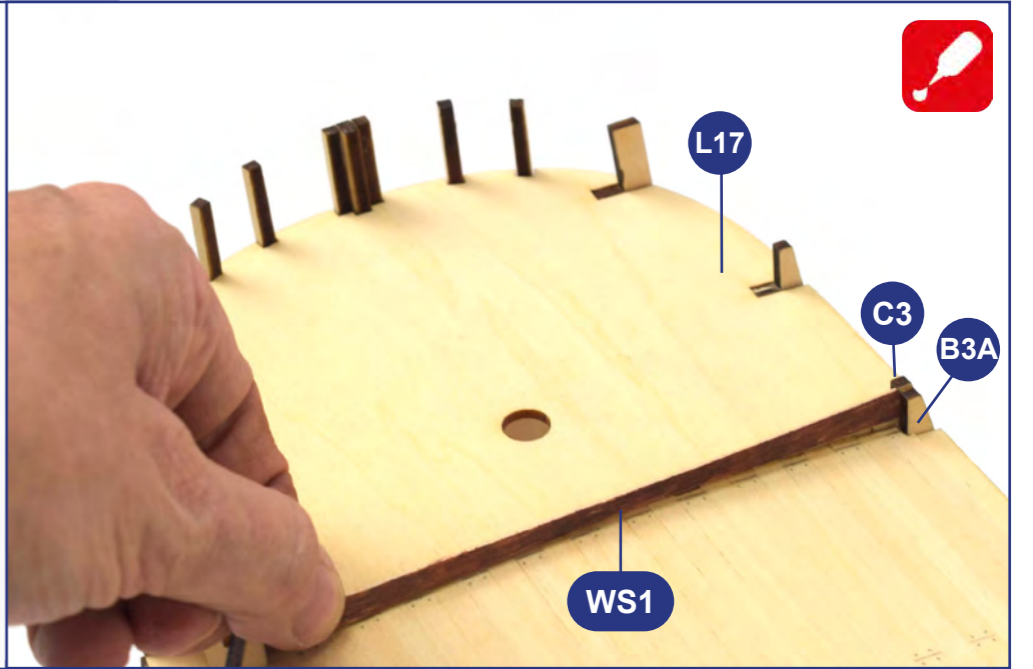

14

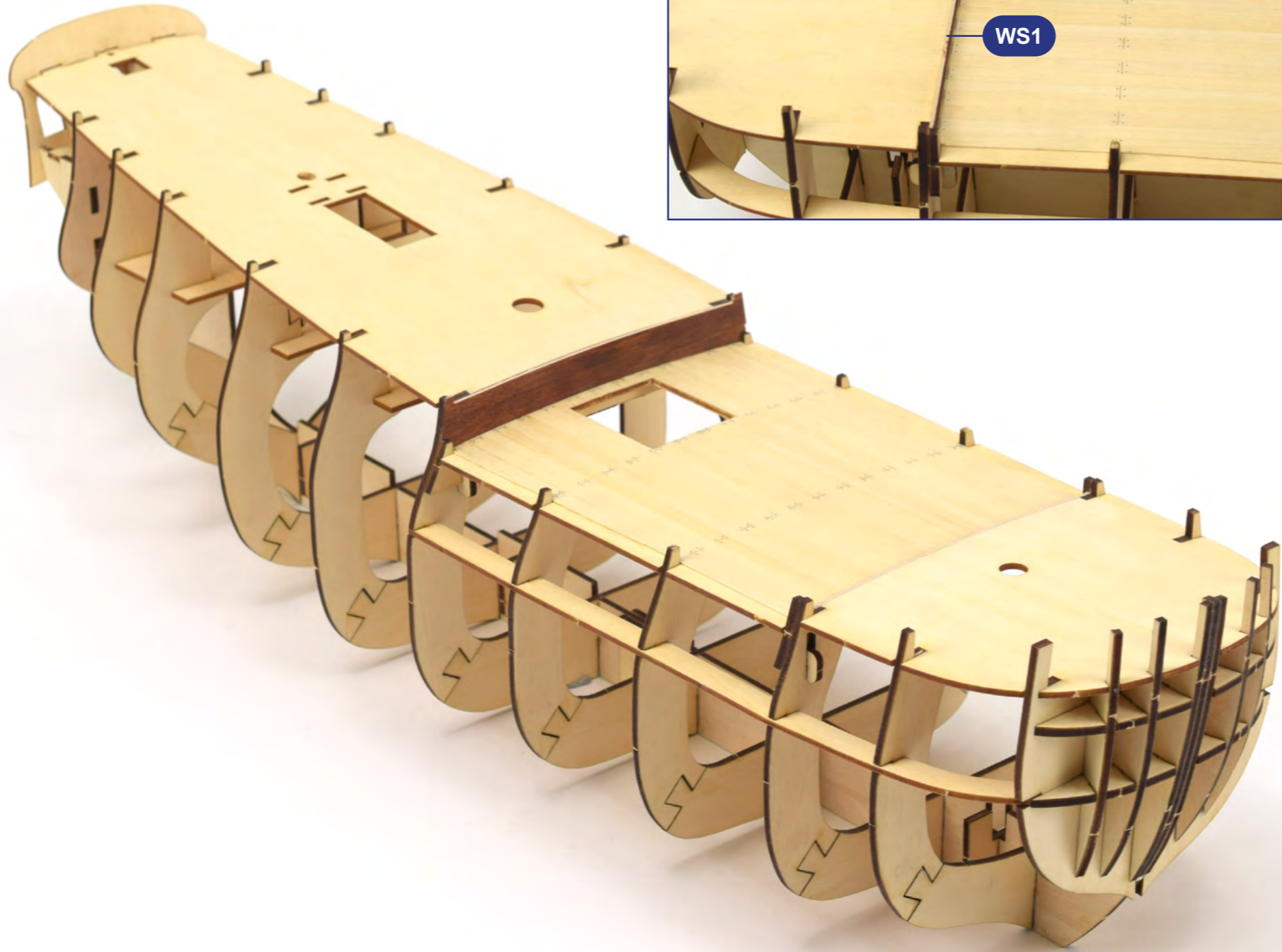
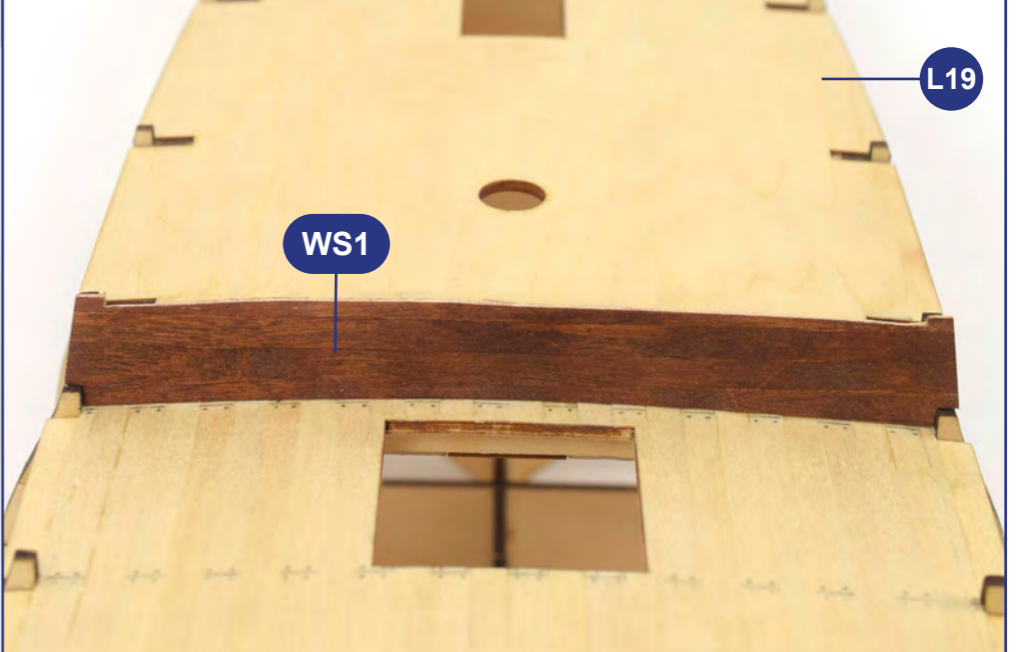
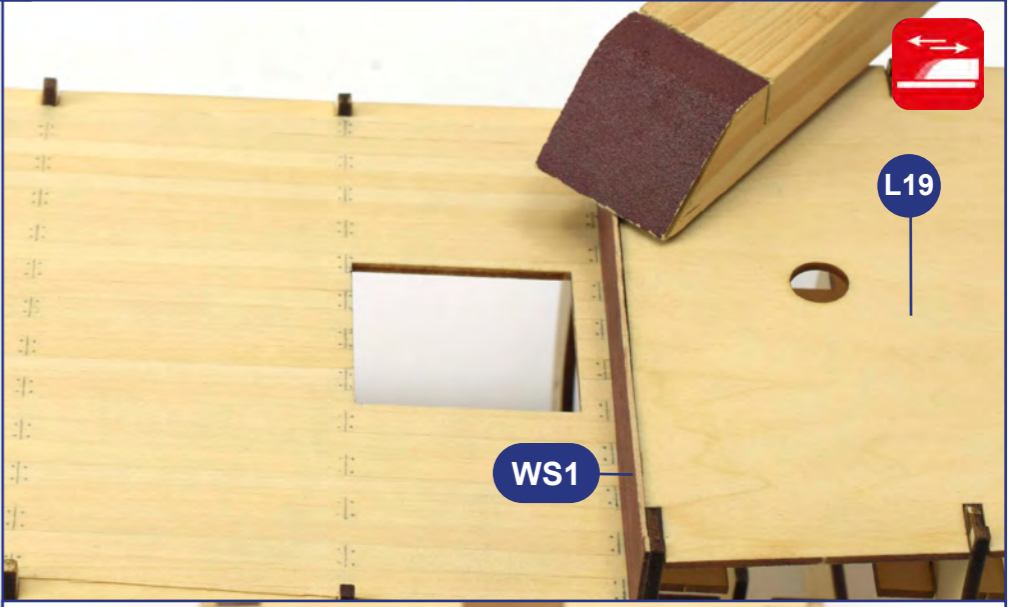
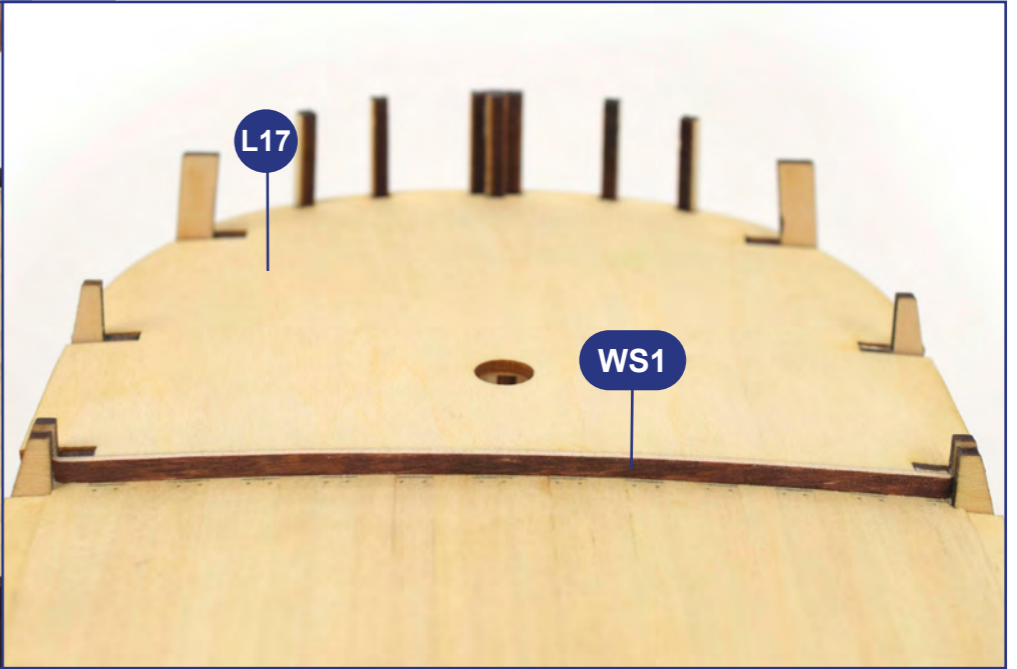
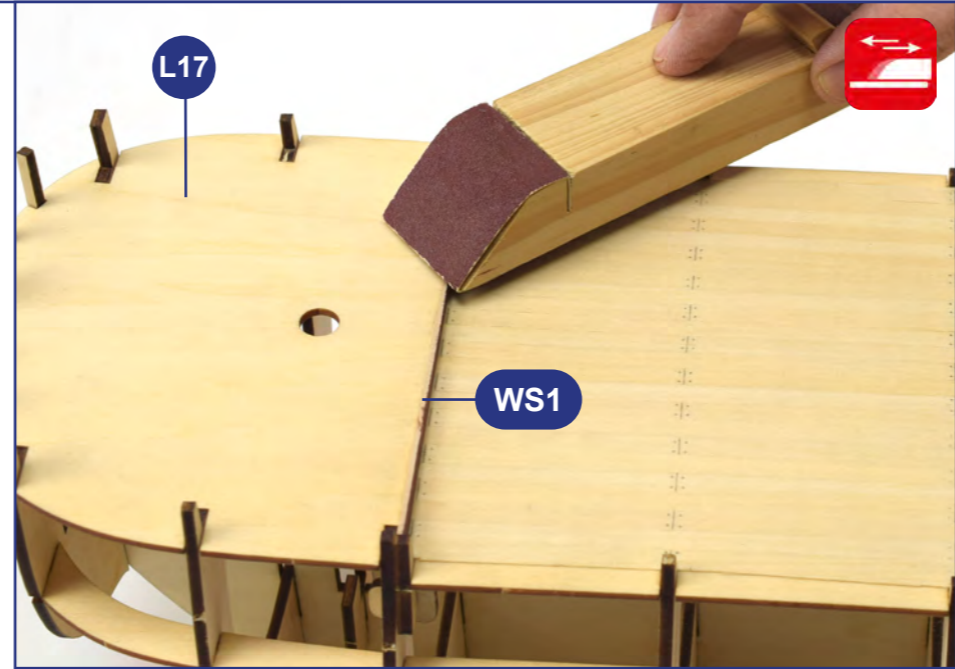

01

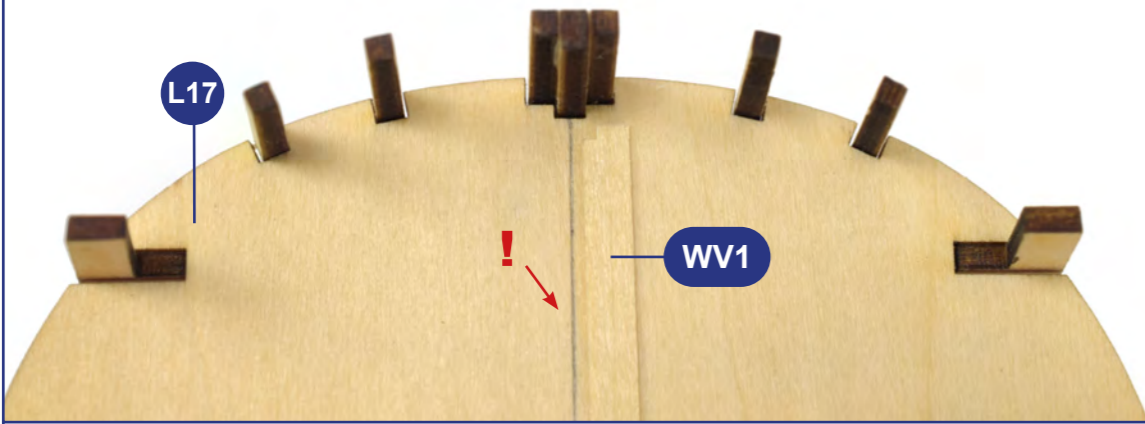

L17

WV1

L17

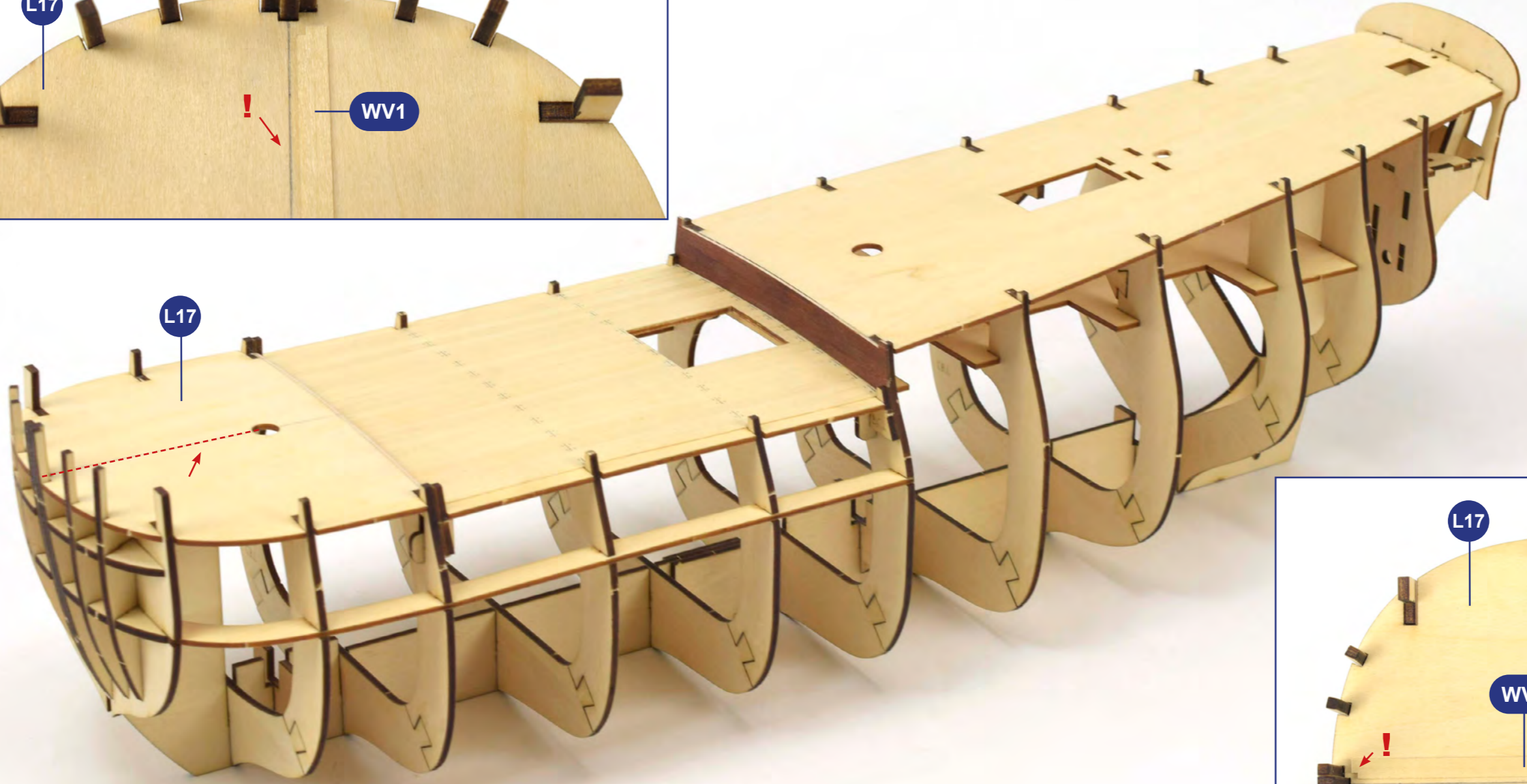

WV1

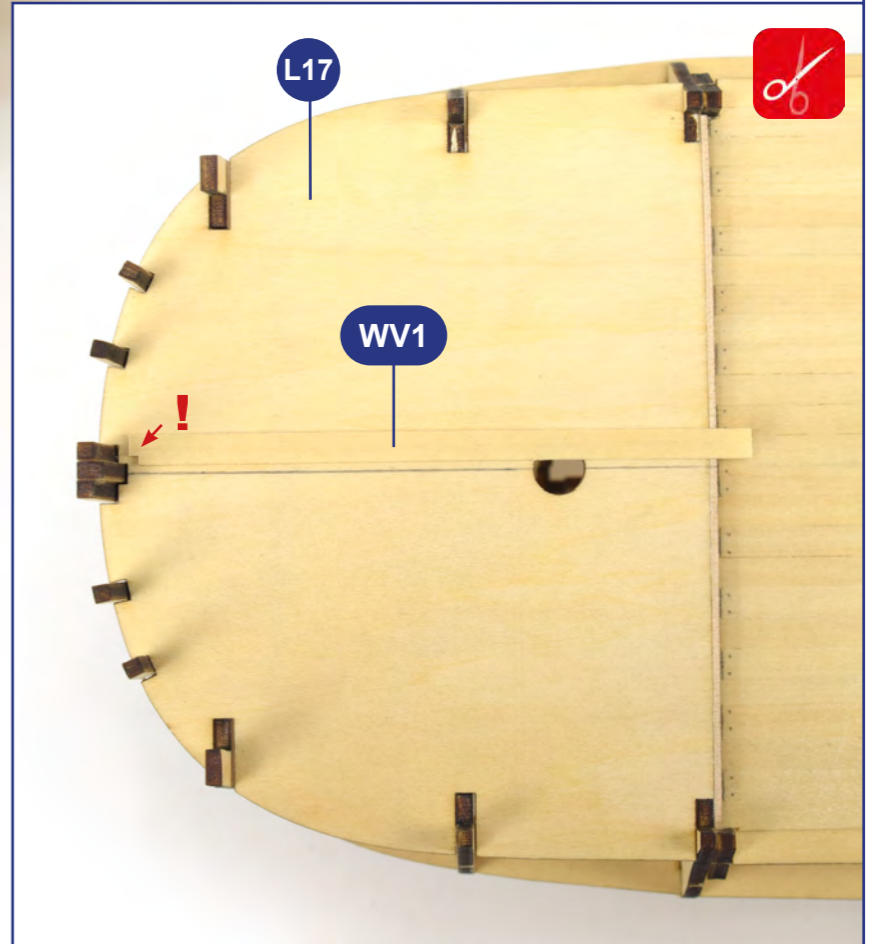

L17

WV1



02

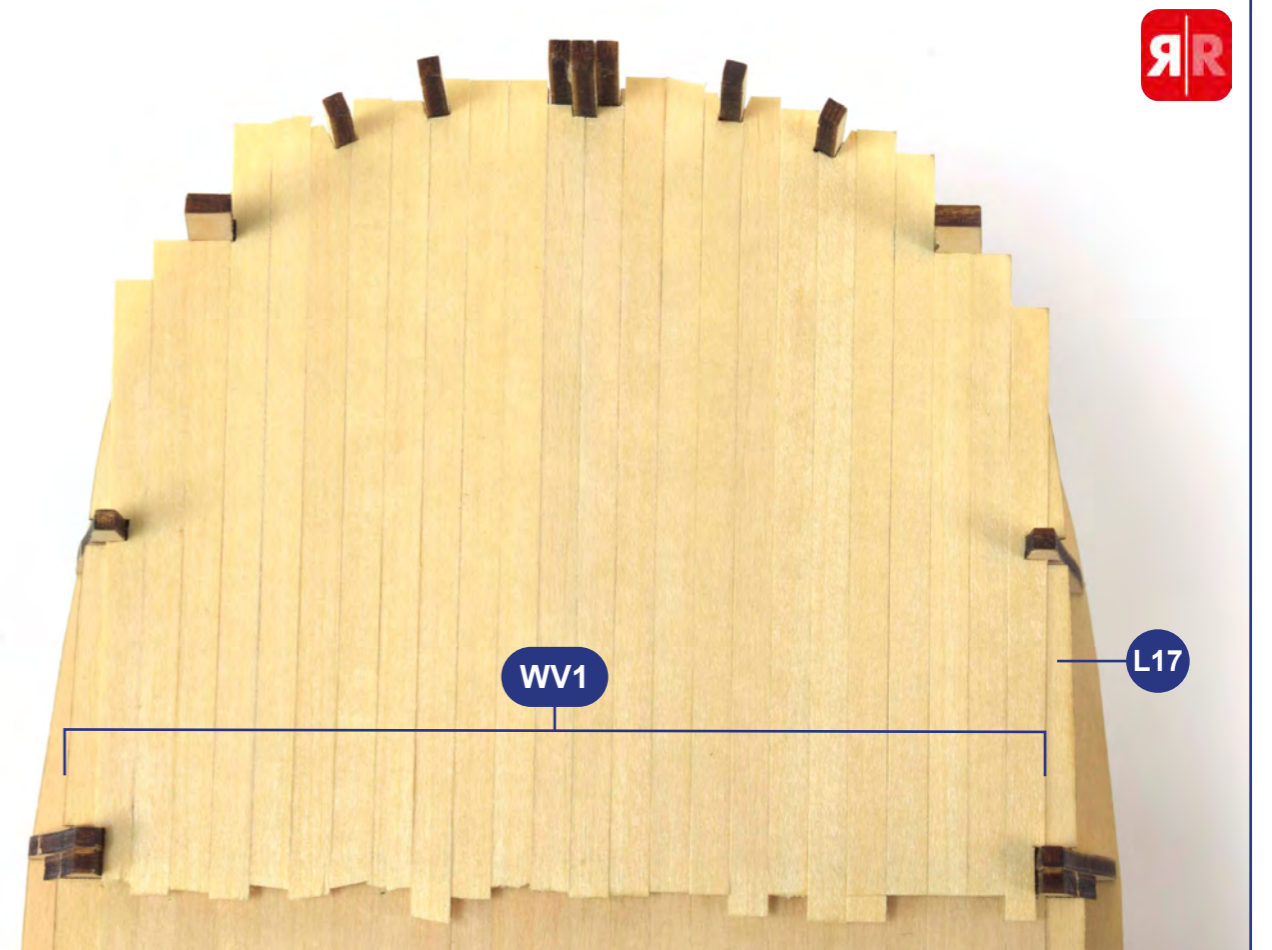
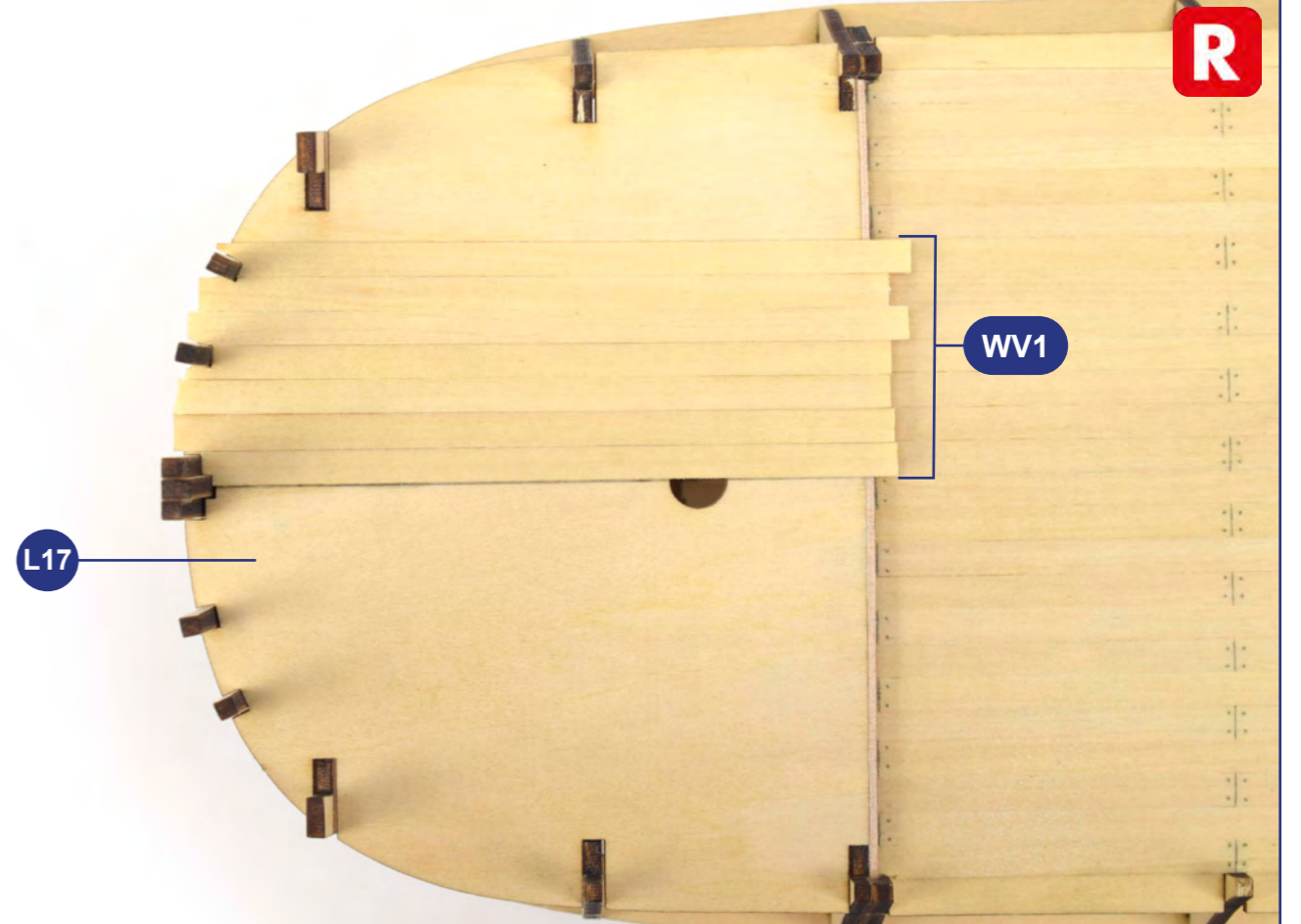
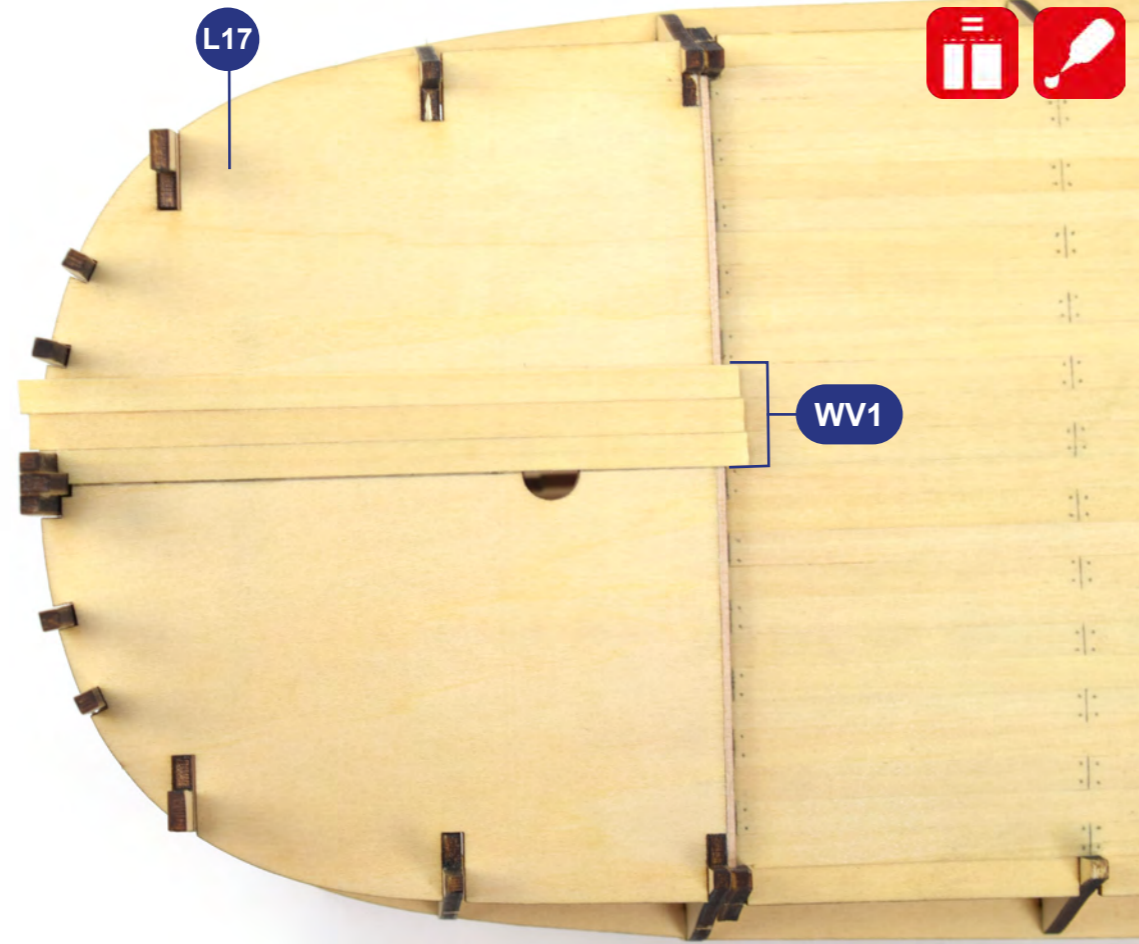

03

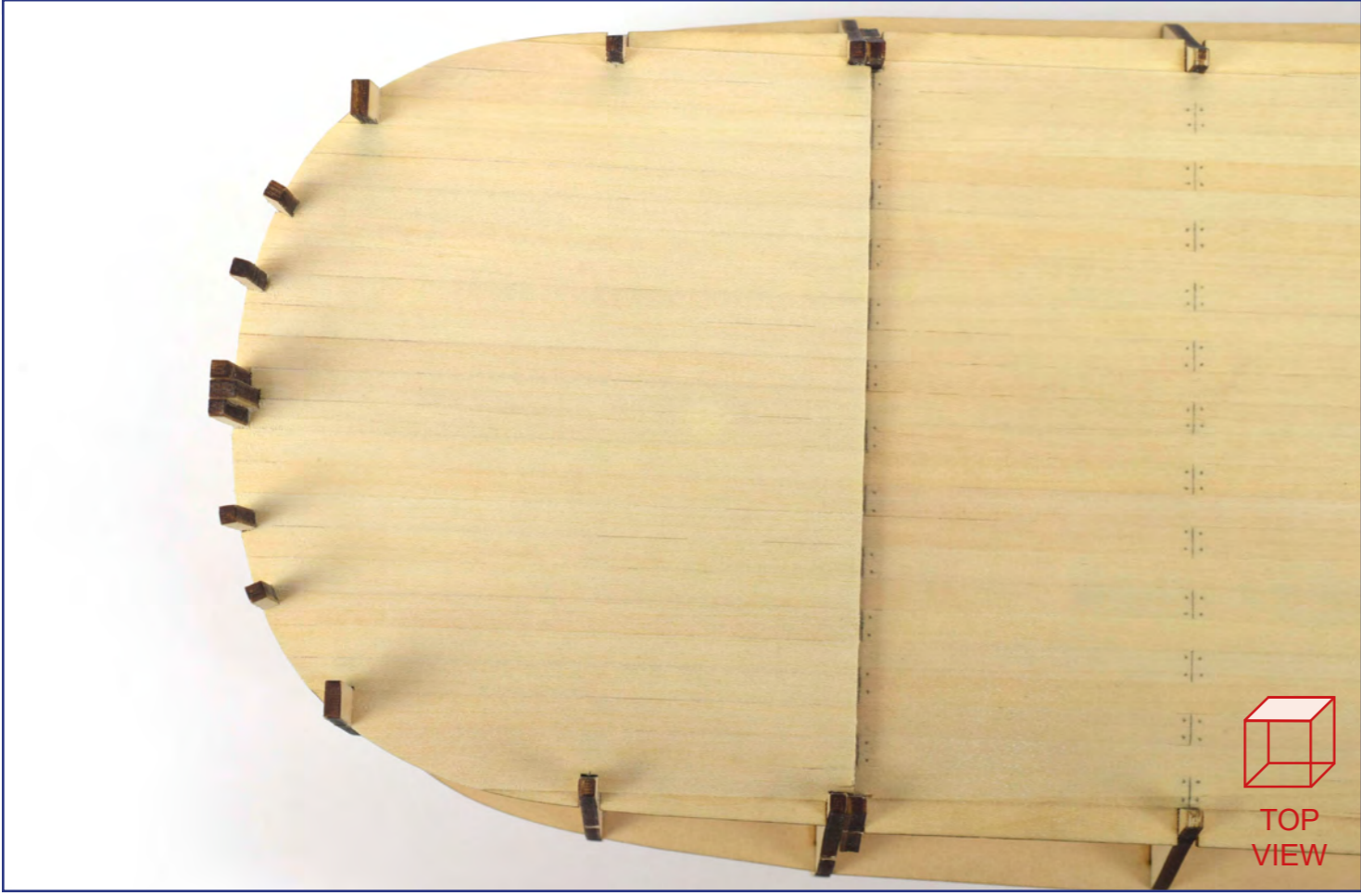
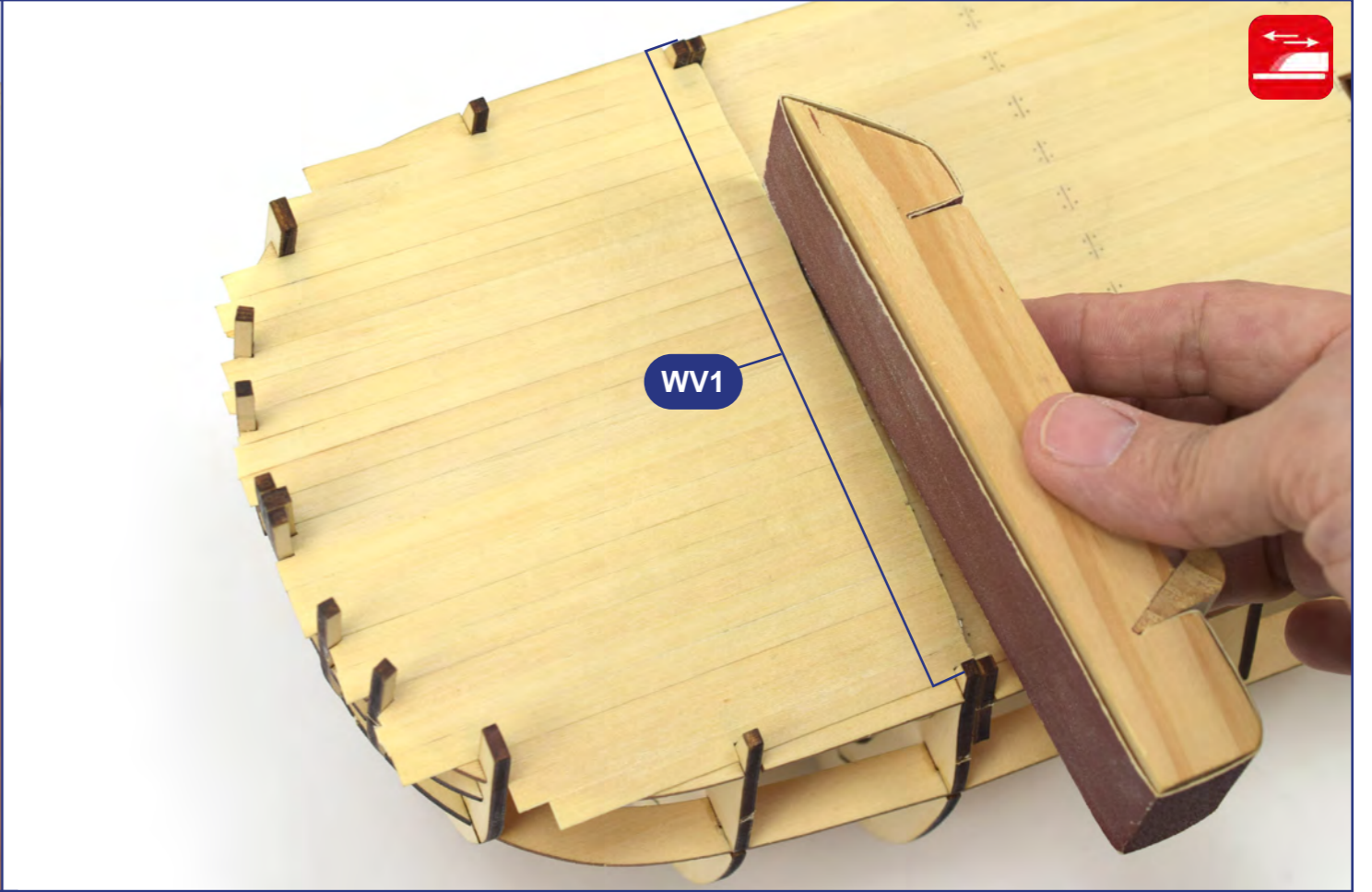
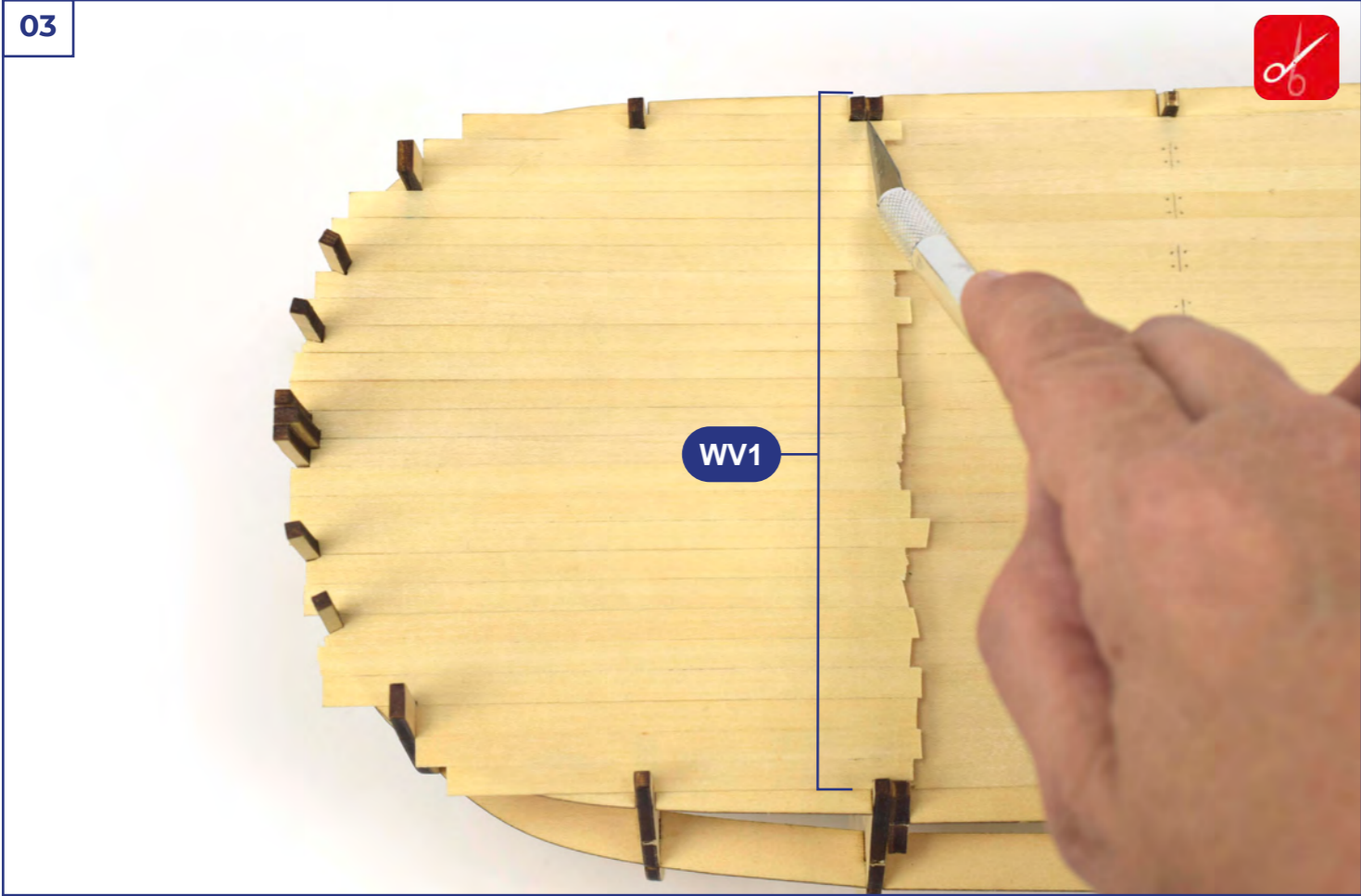

04

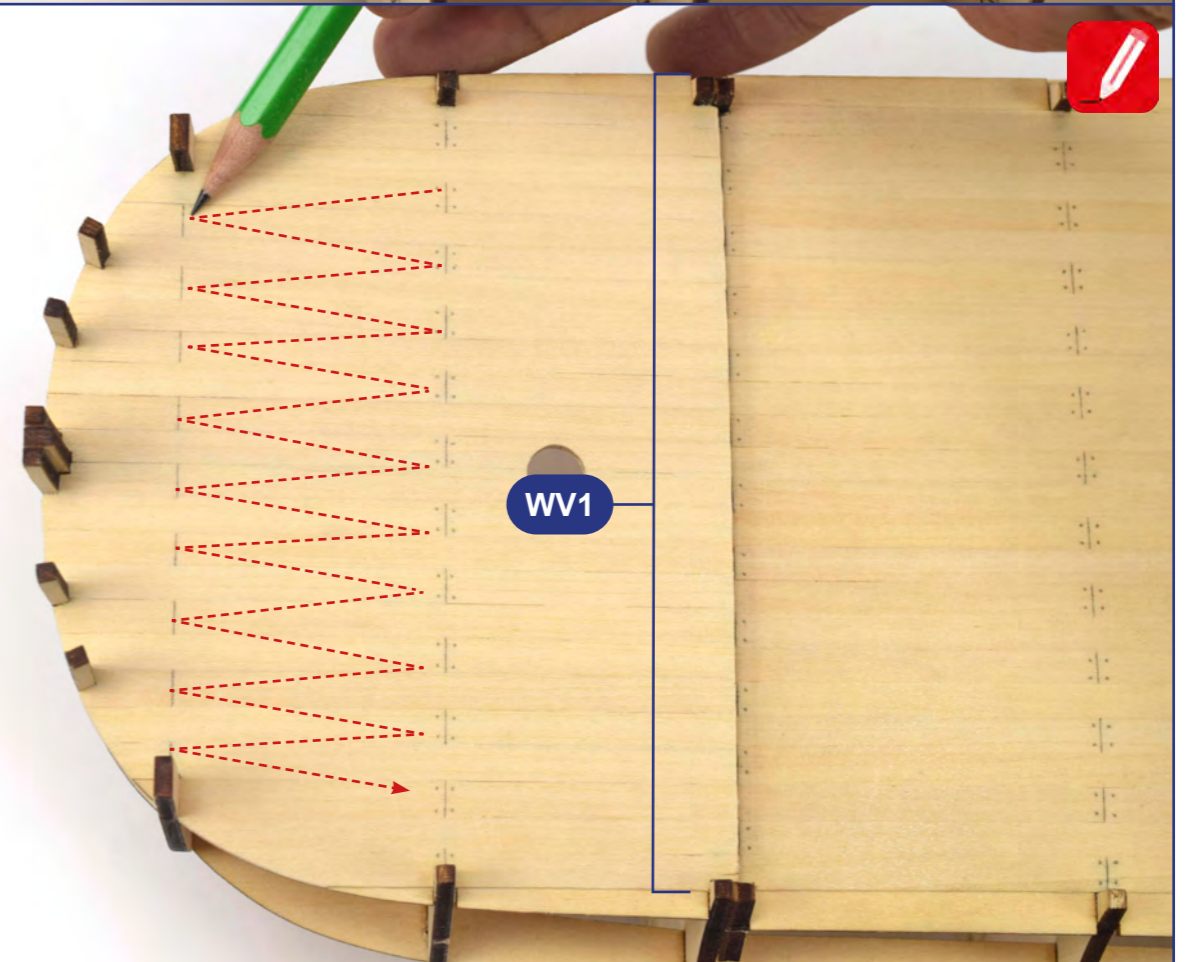

01

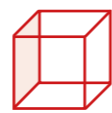
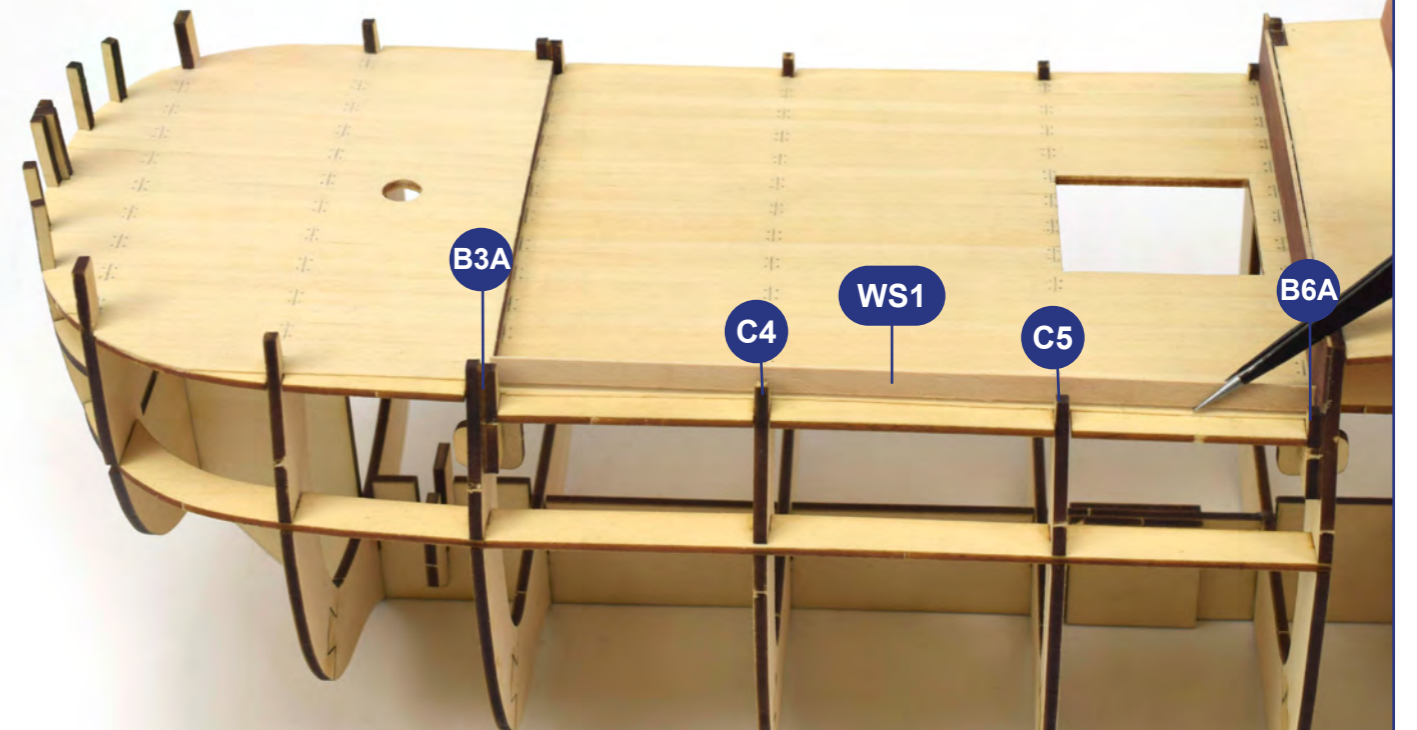
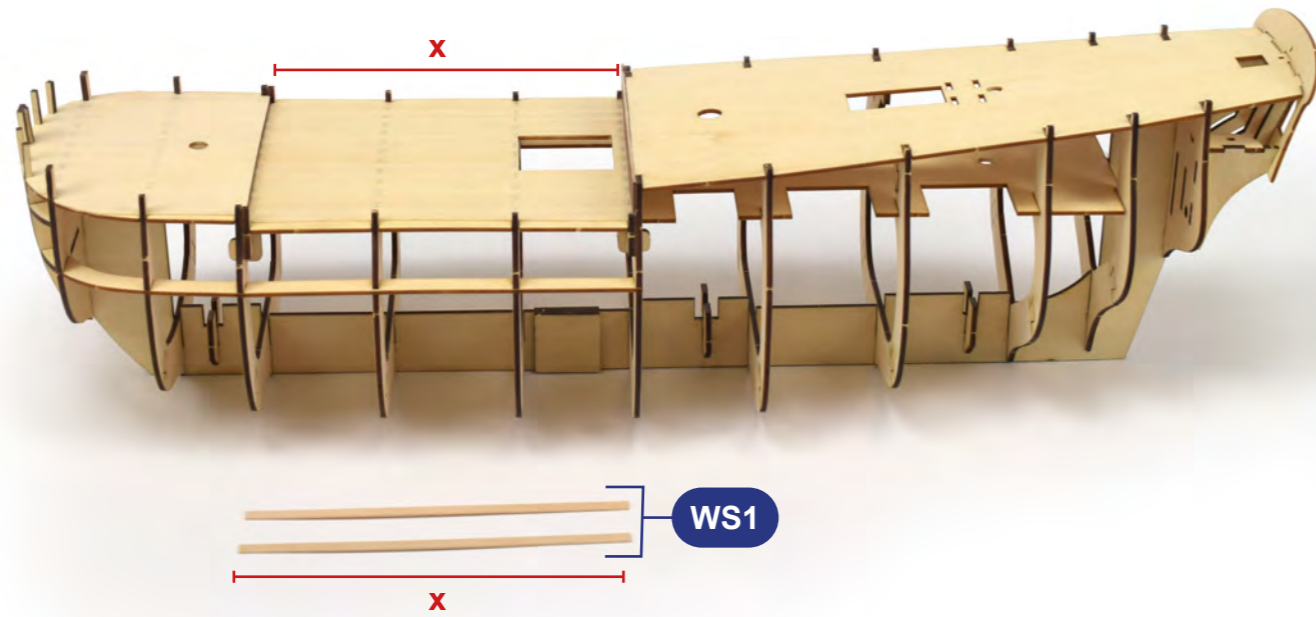

LEFT VIEW

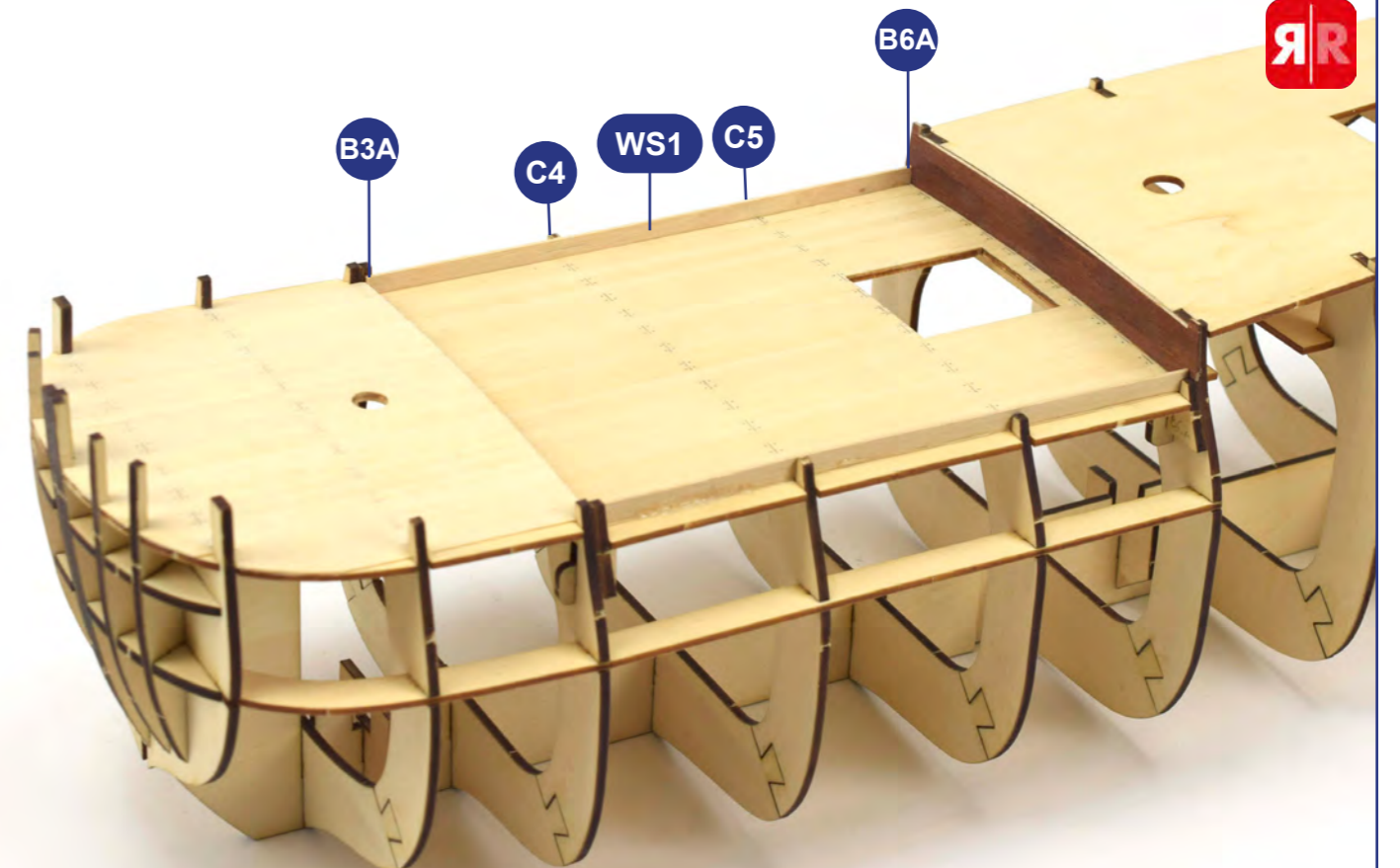
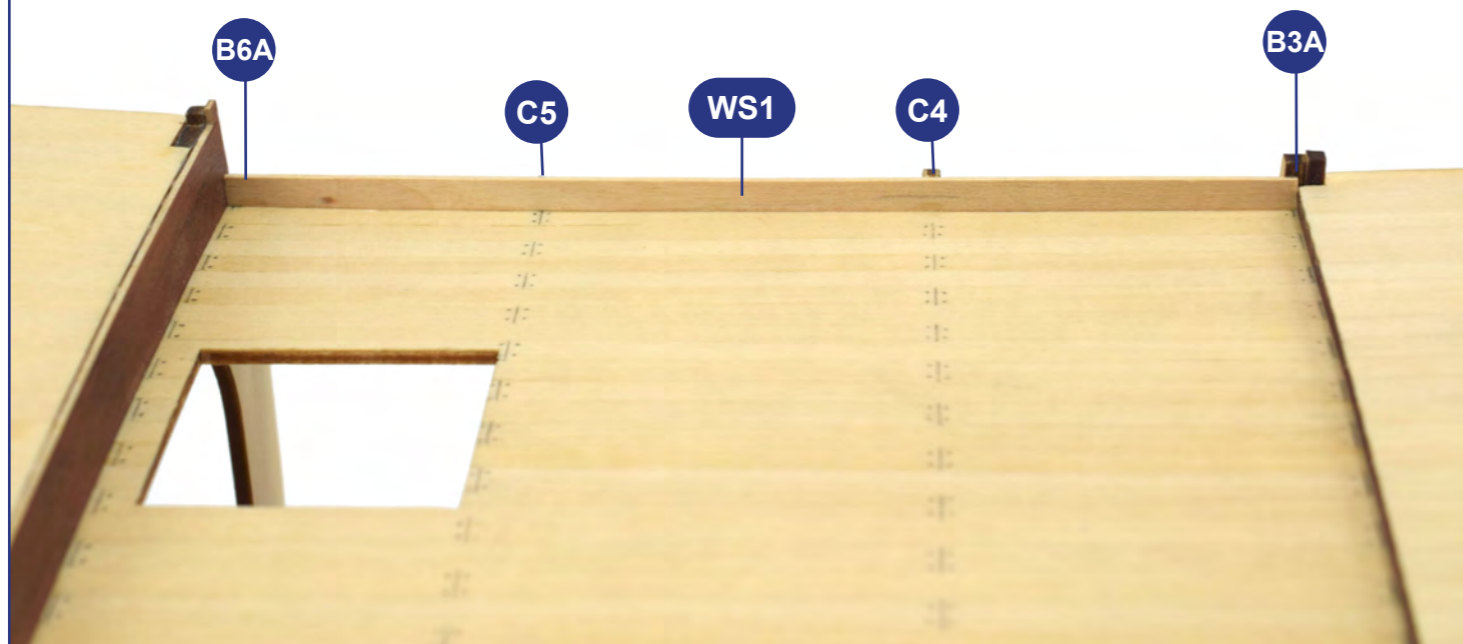

02

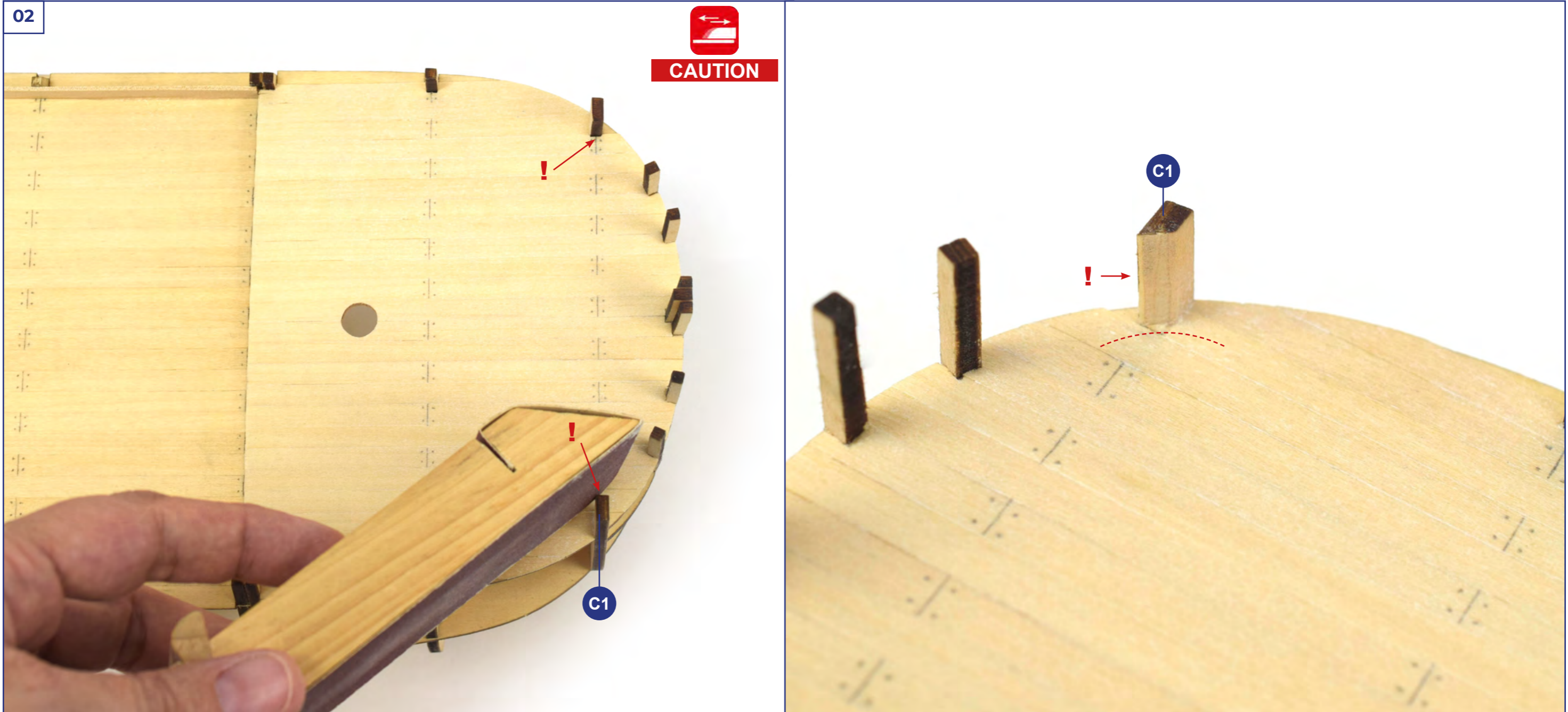

03

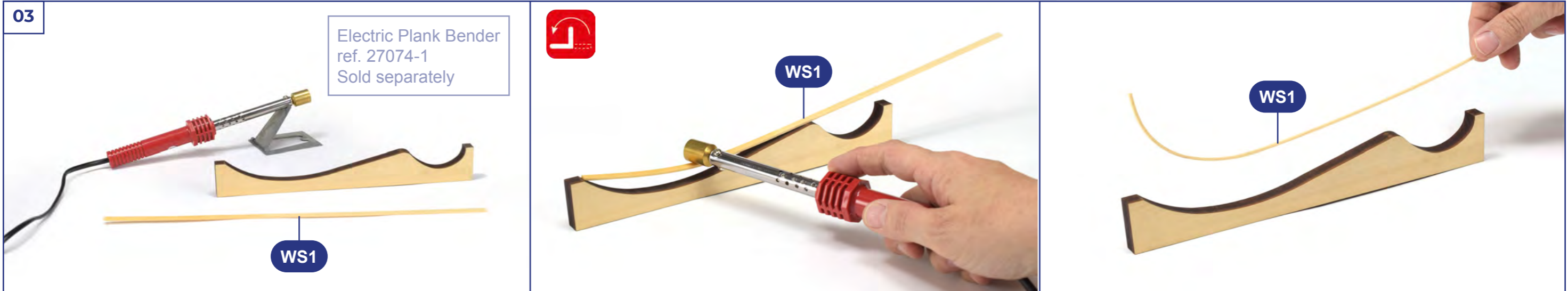

04

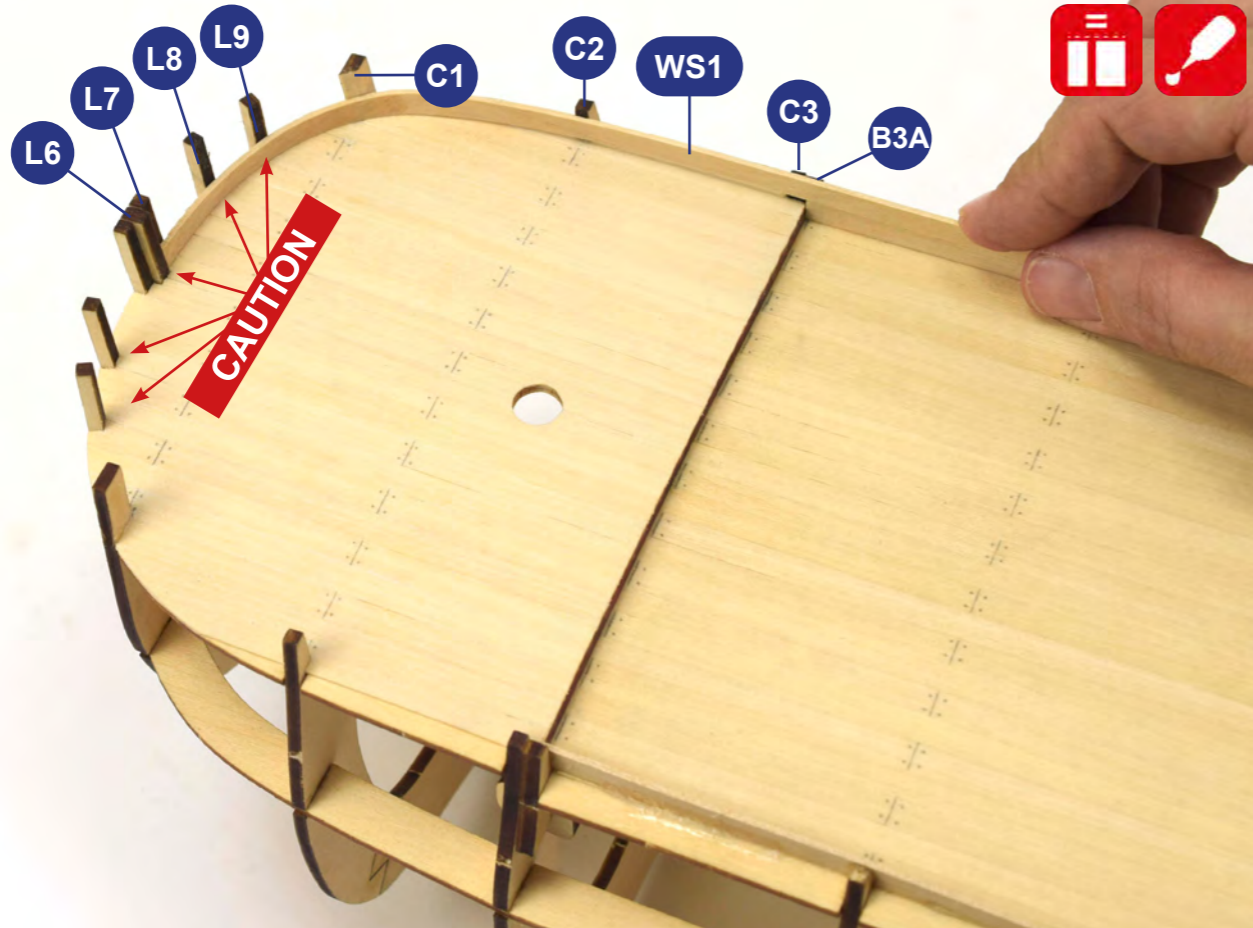

05

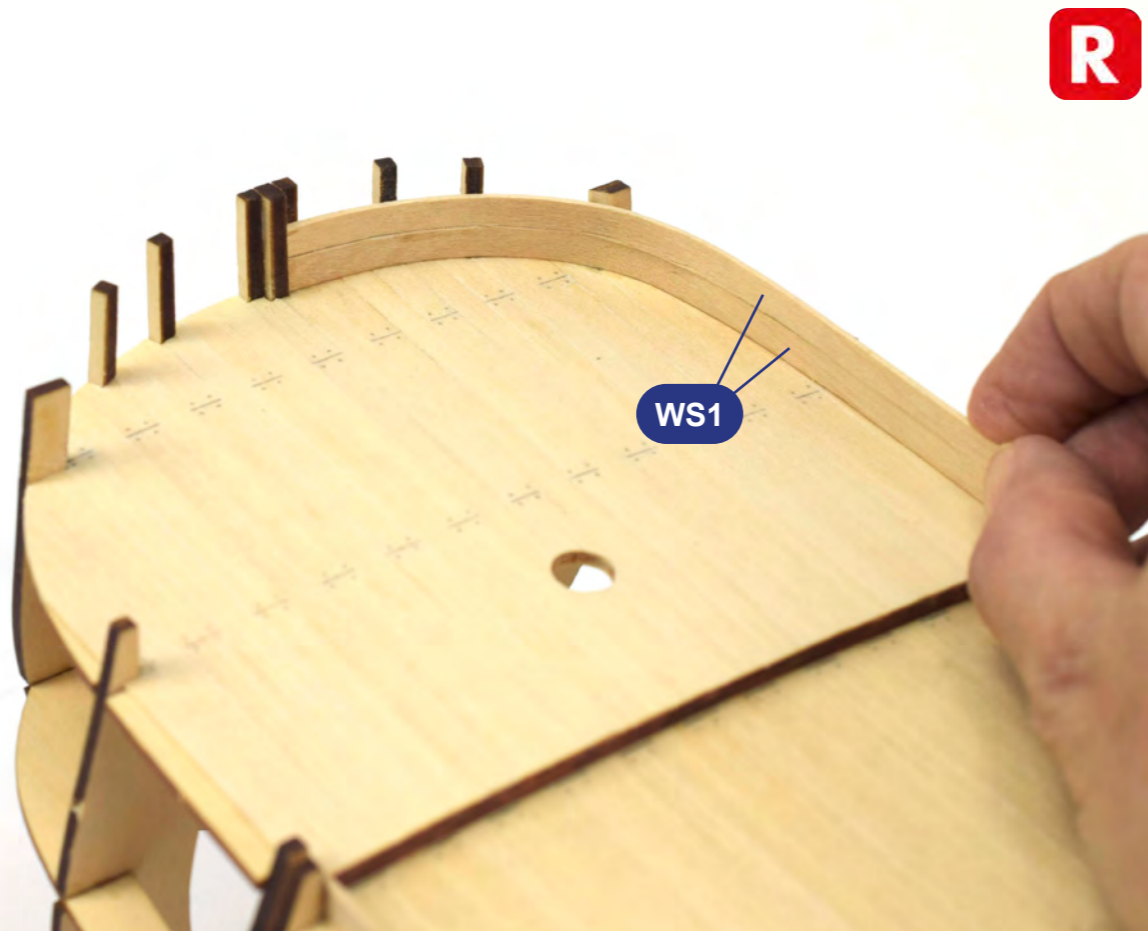

06

R

WS1

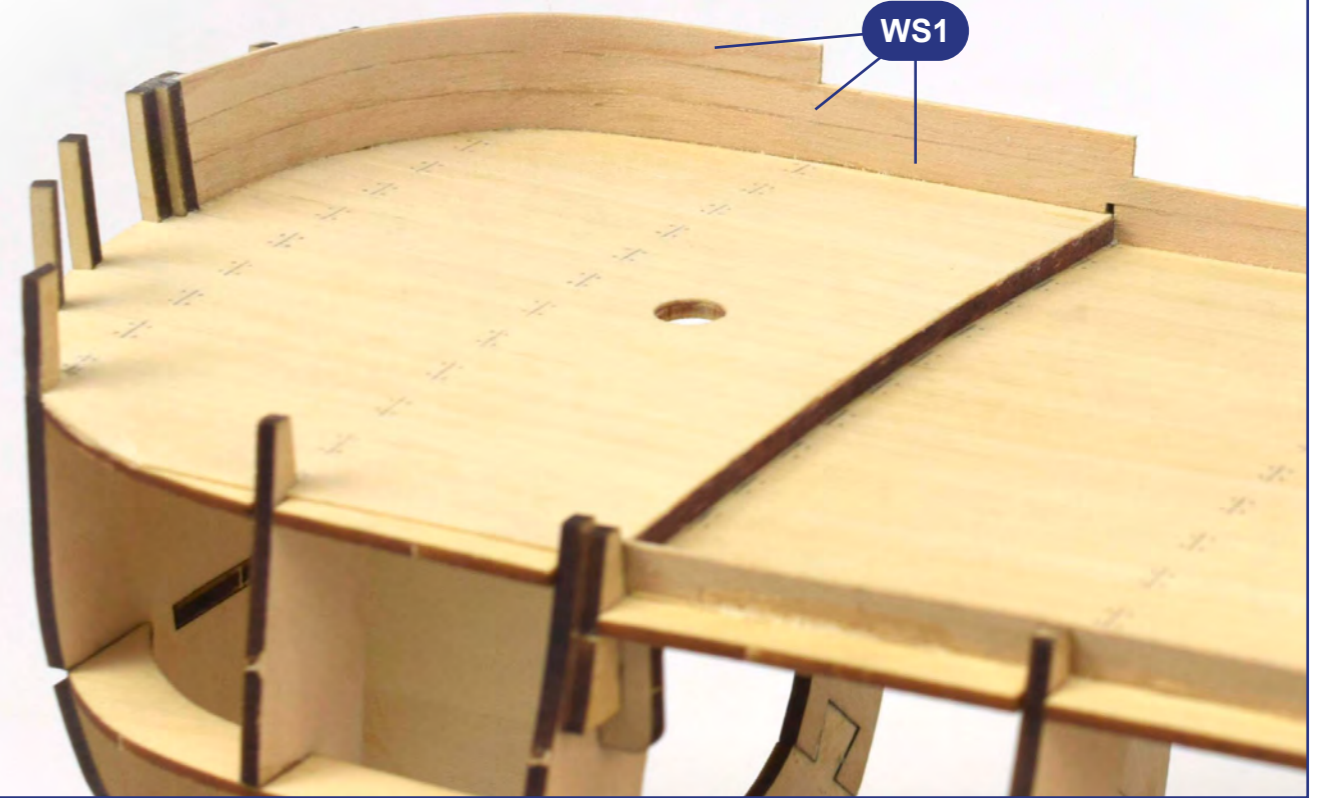
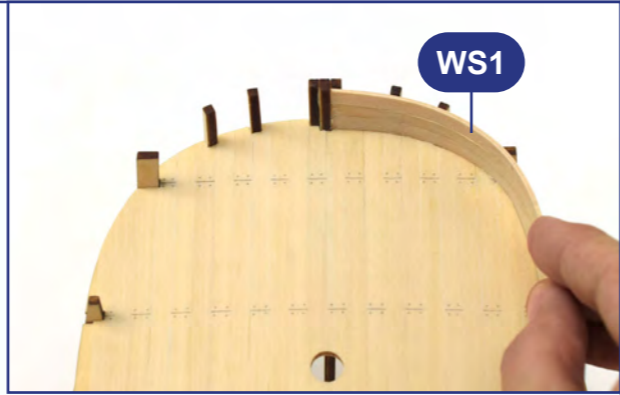
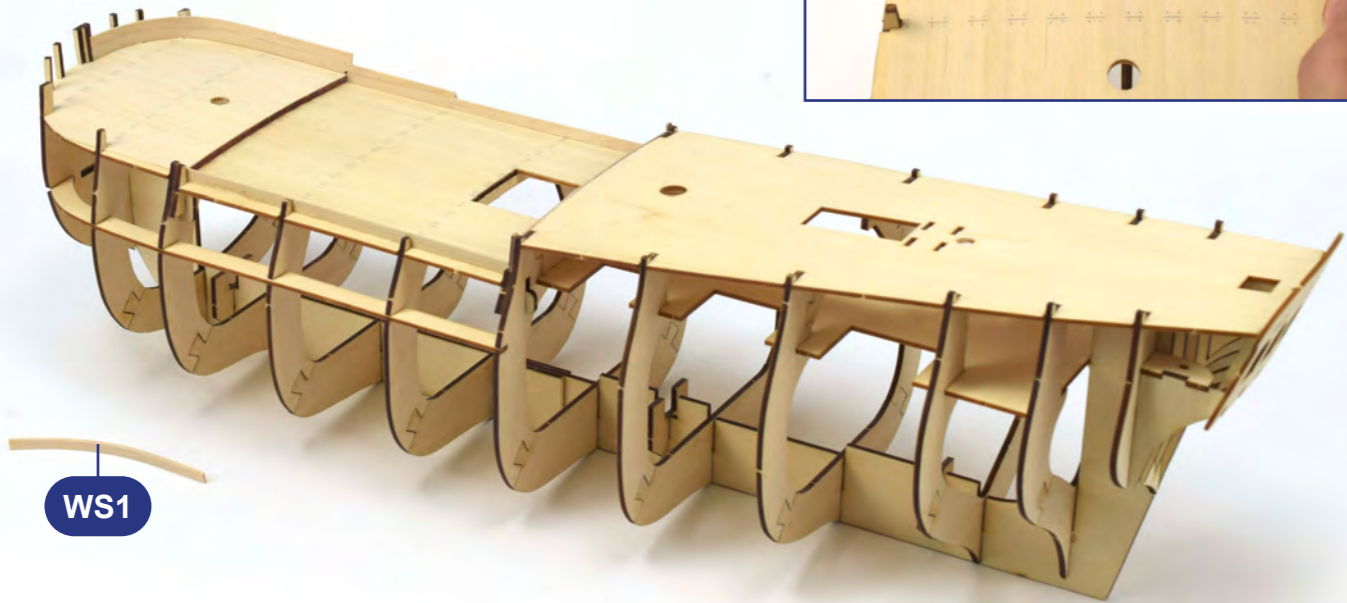

07

R

WS1

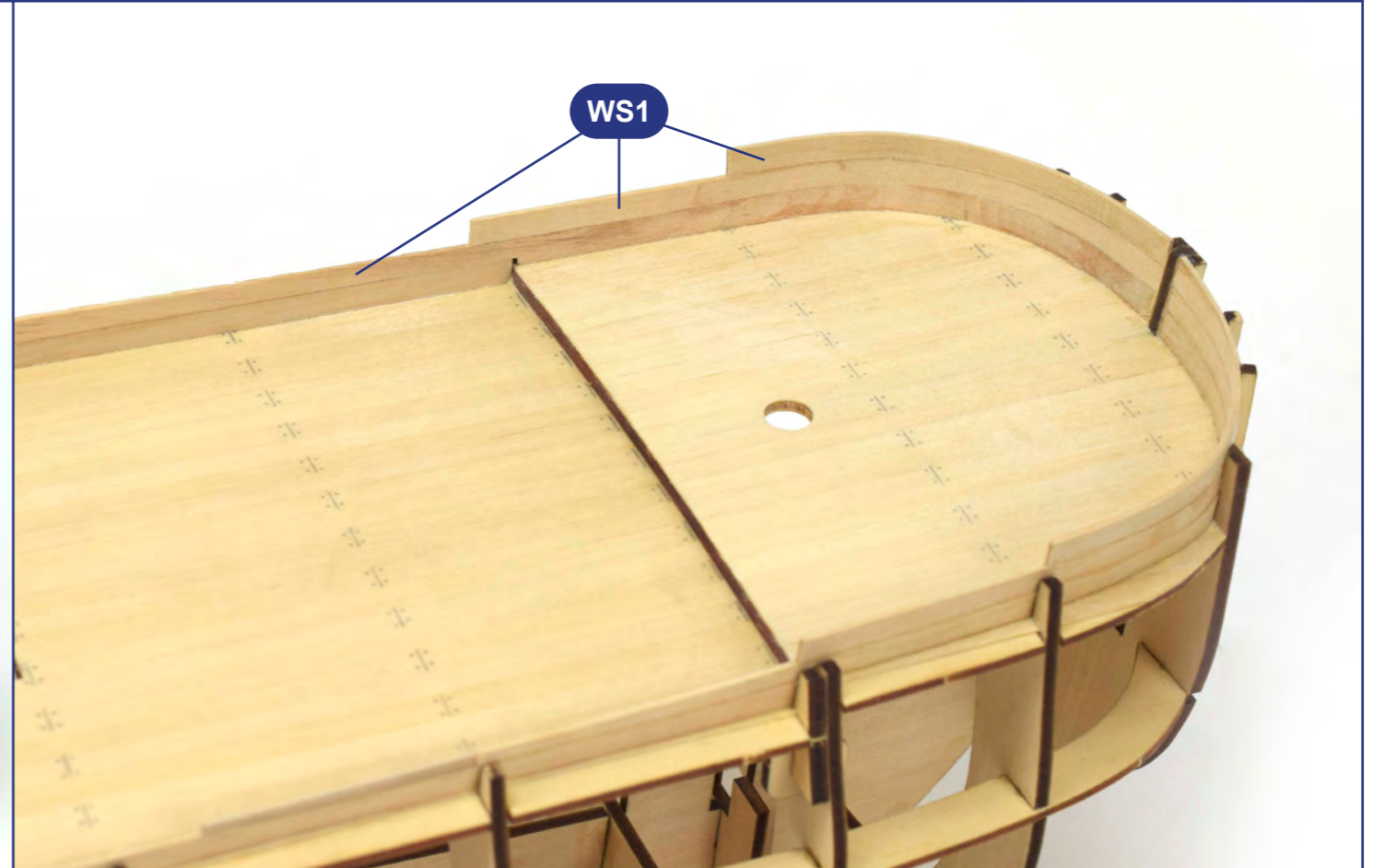
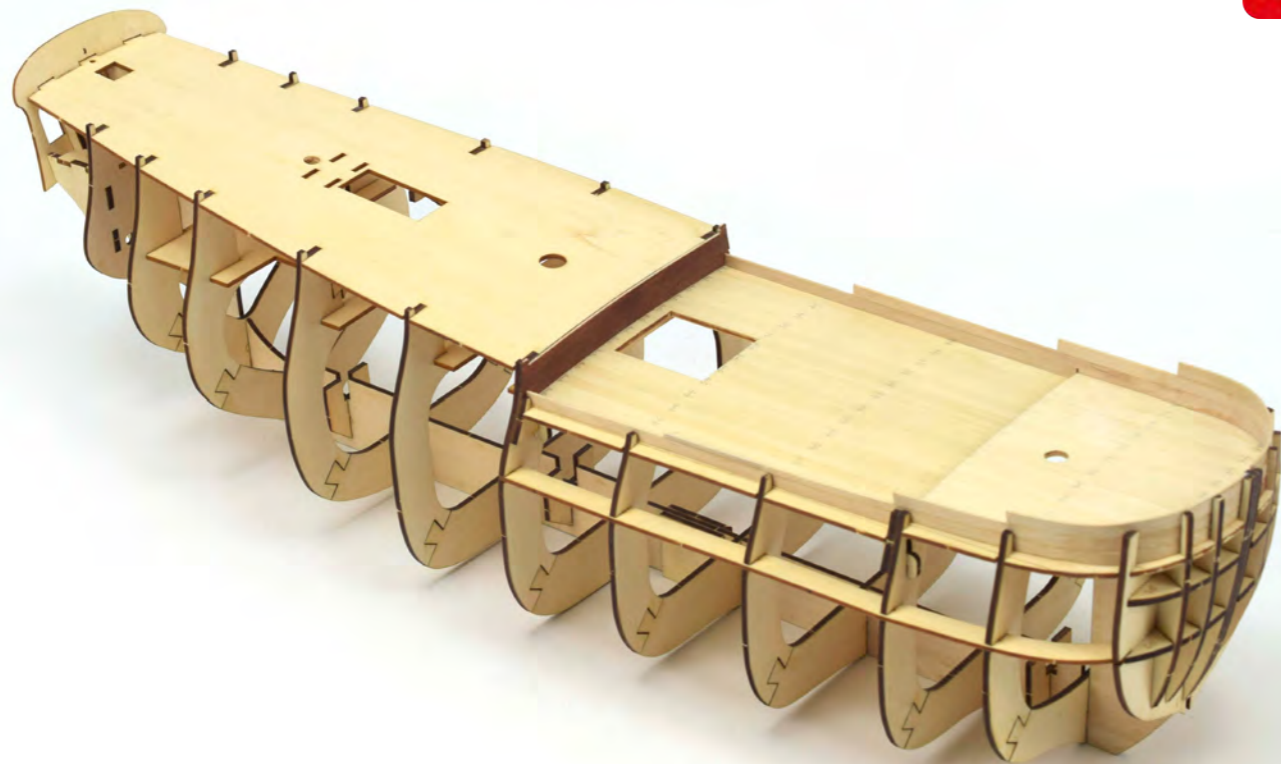

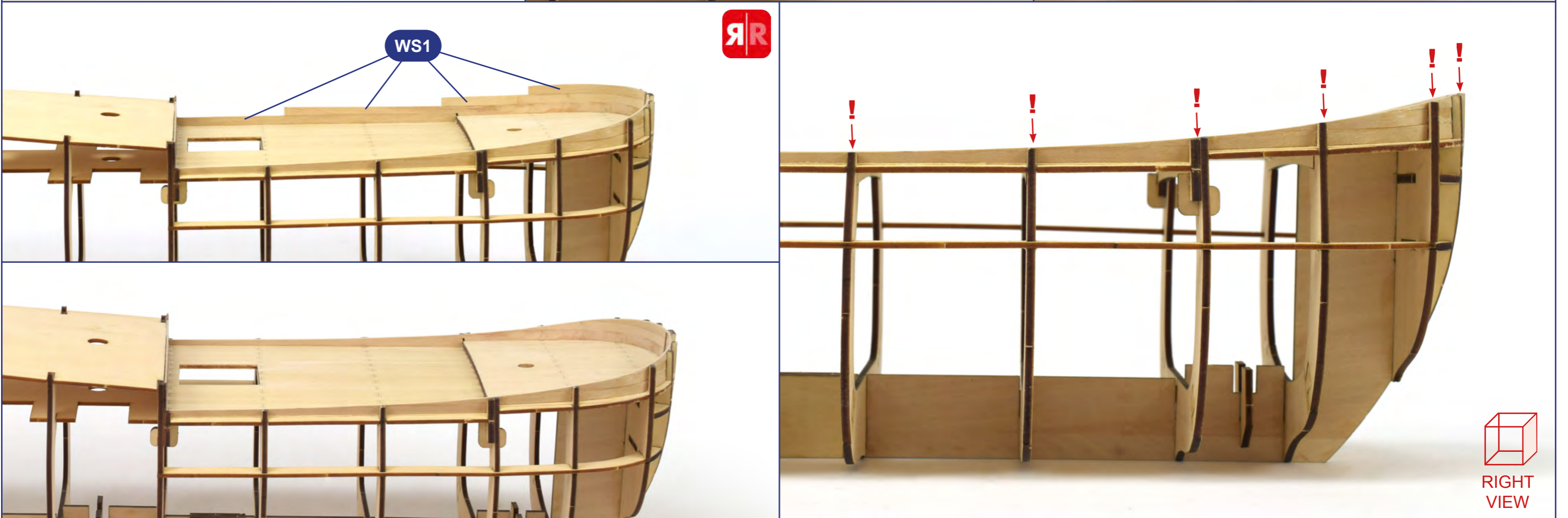
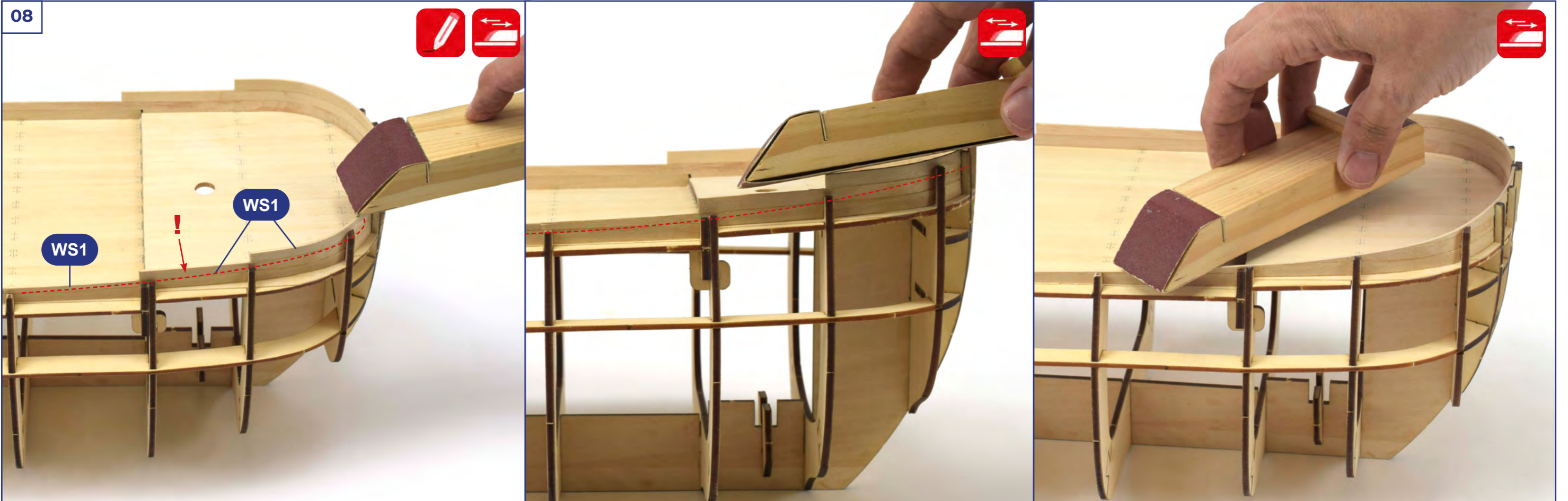

01

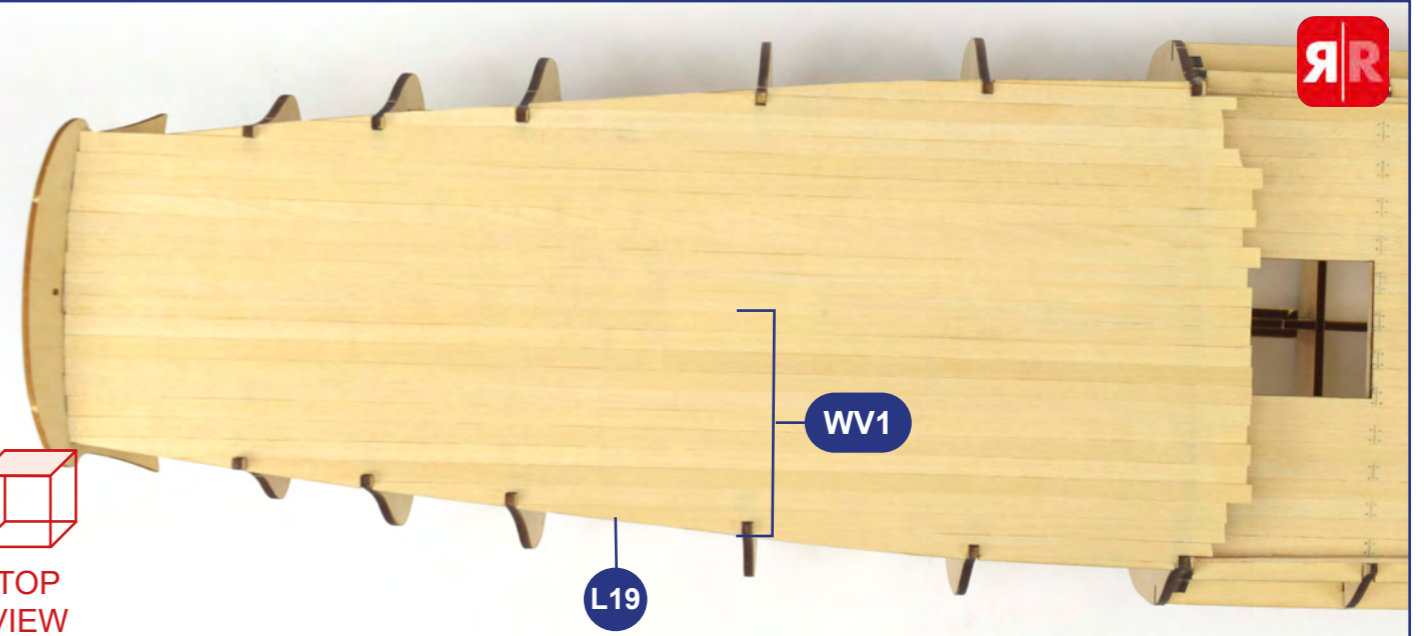
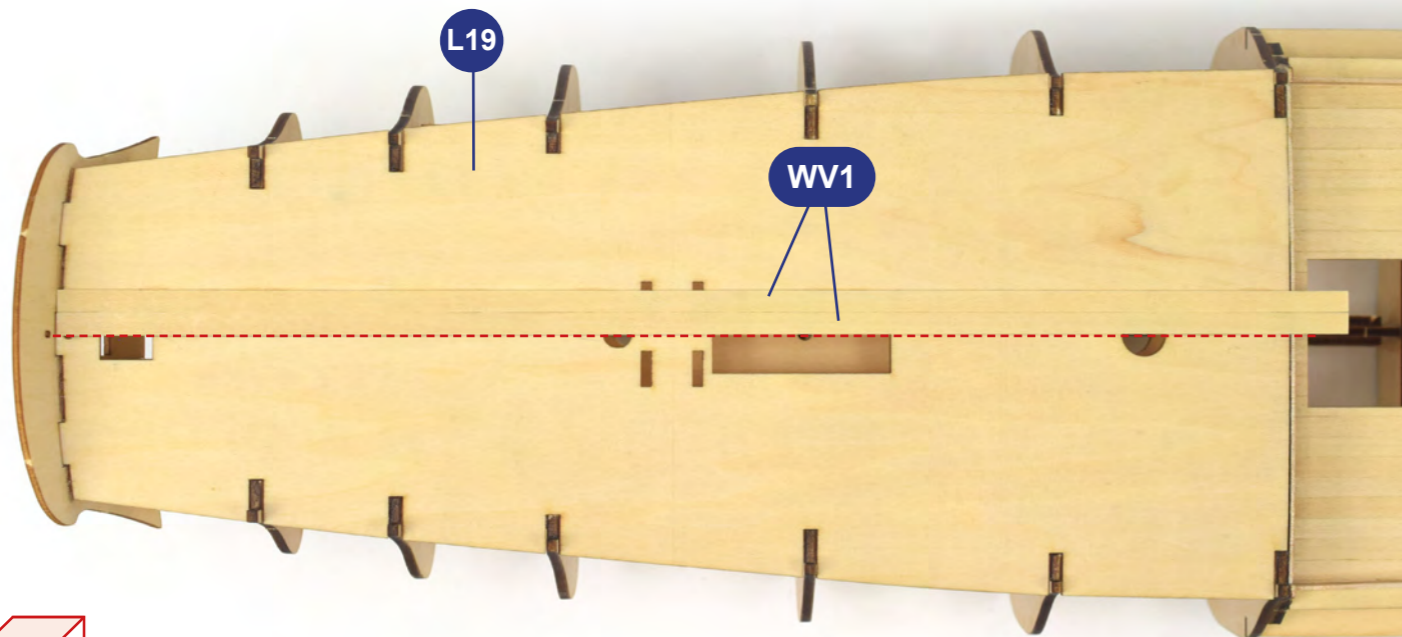
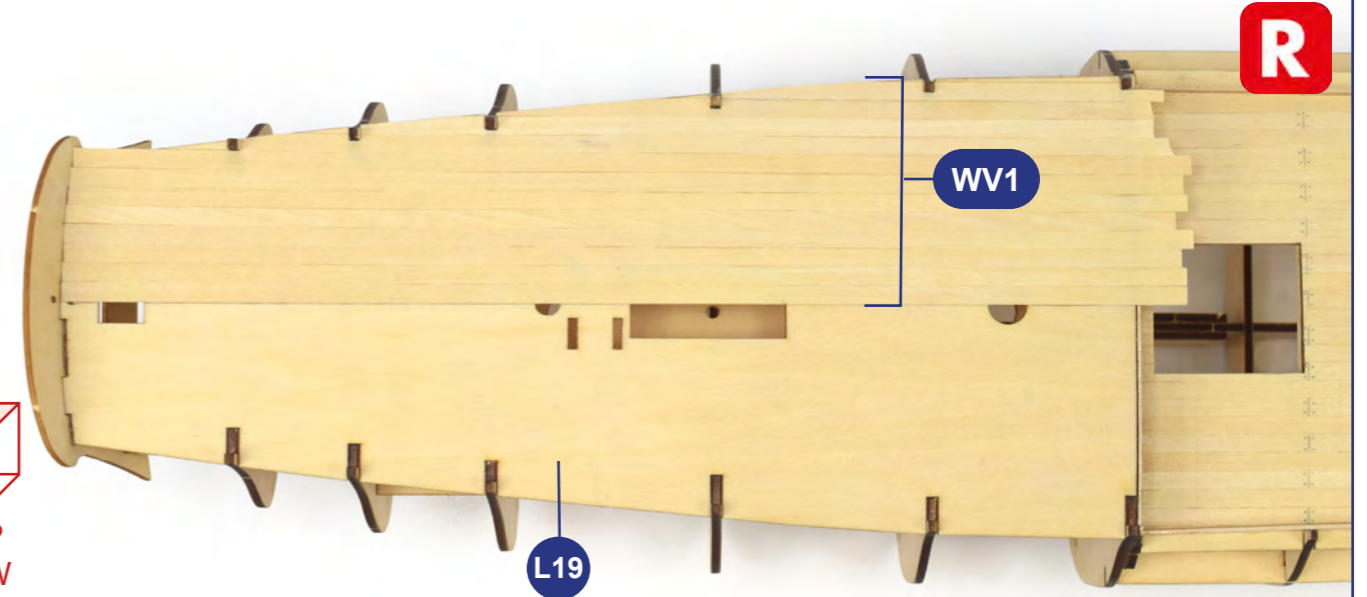
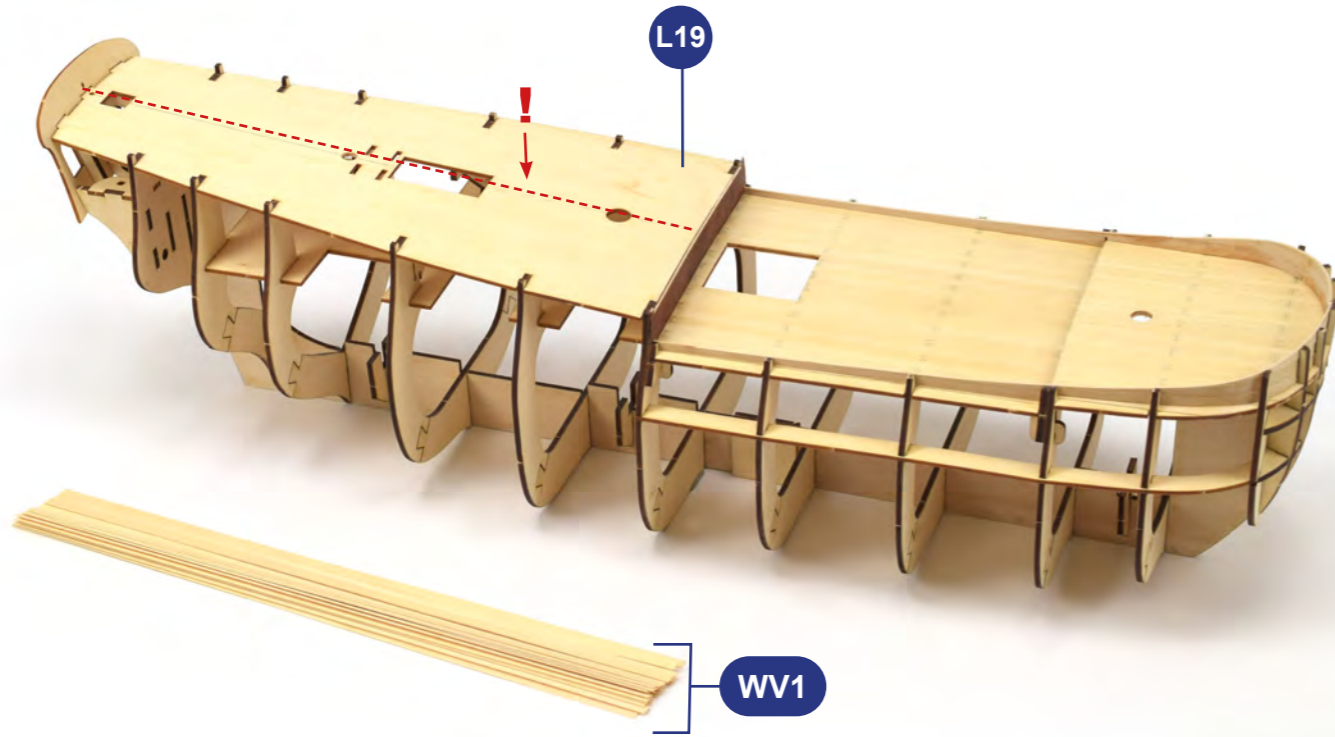

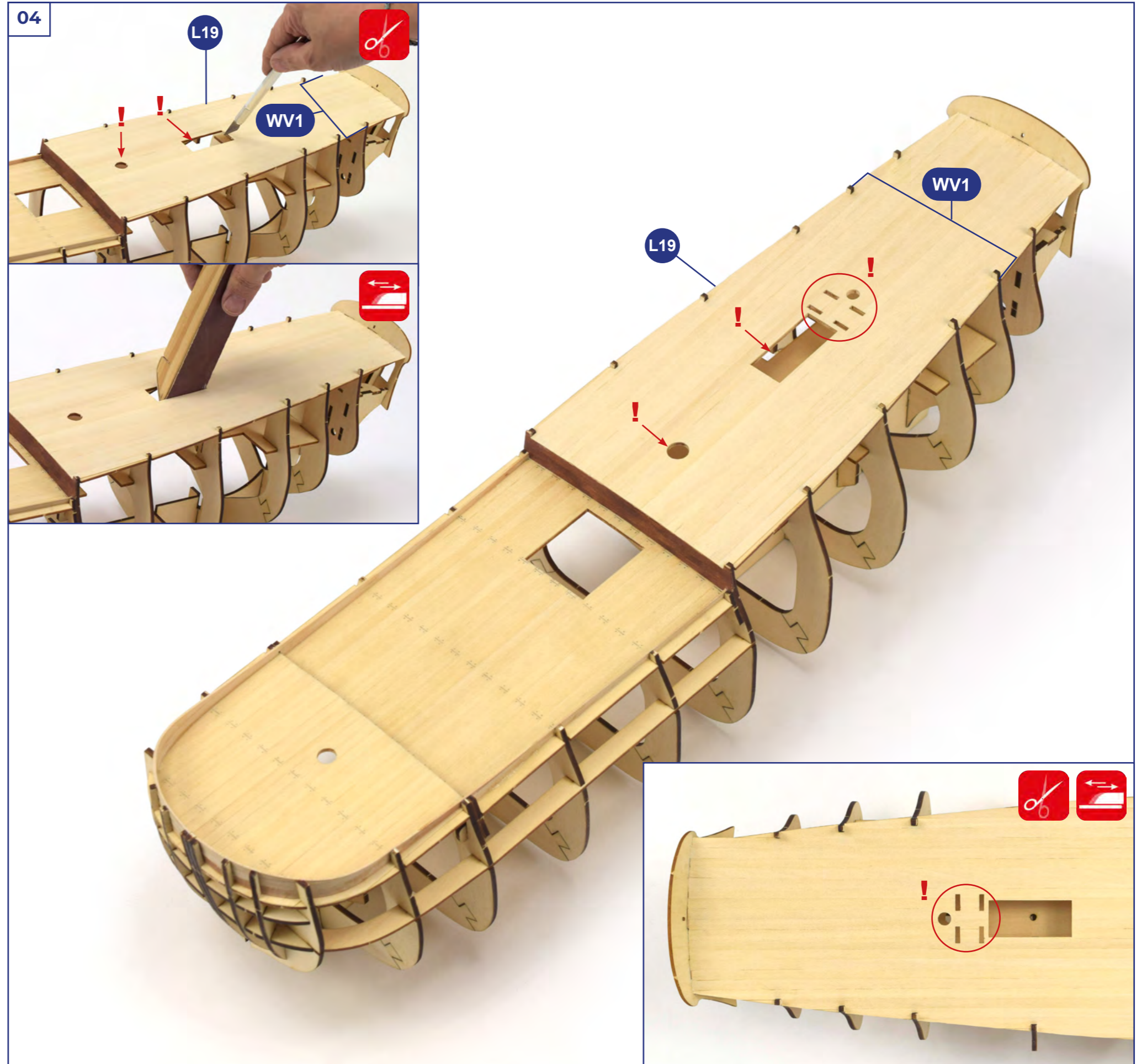
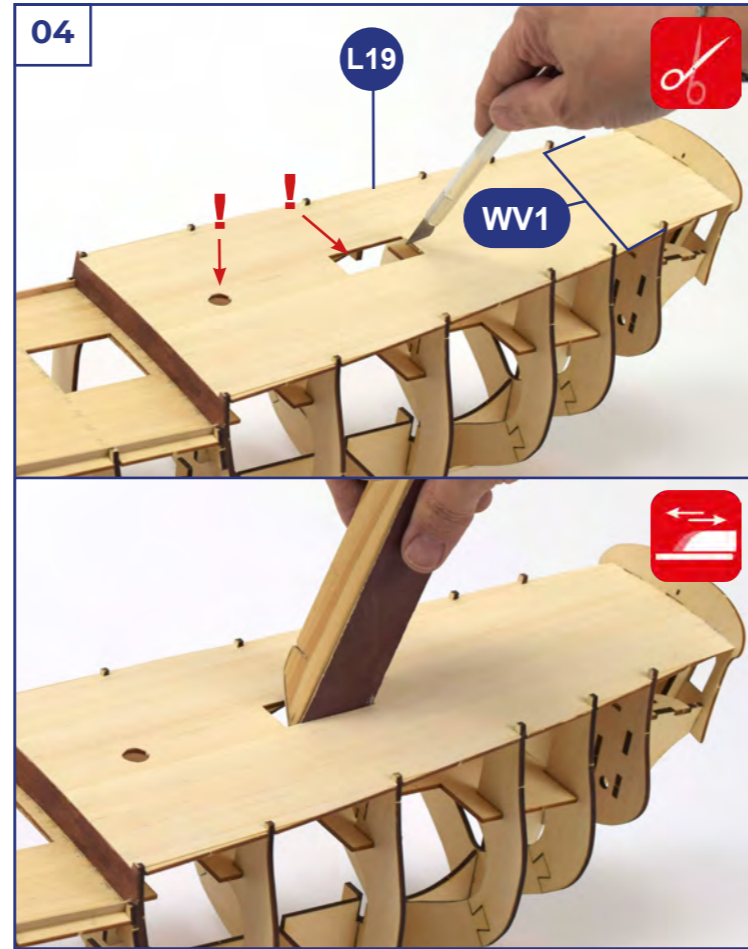
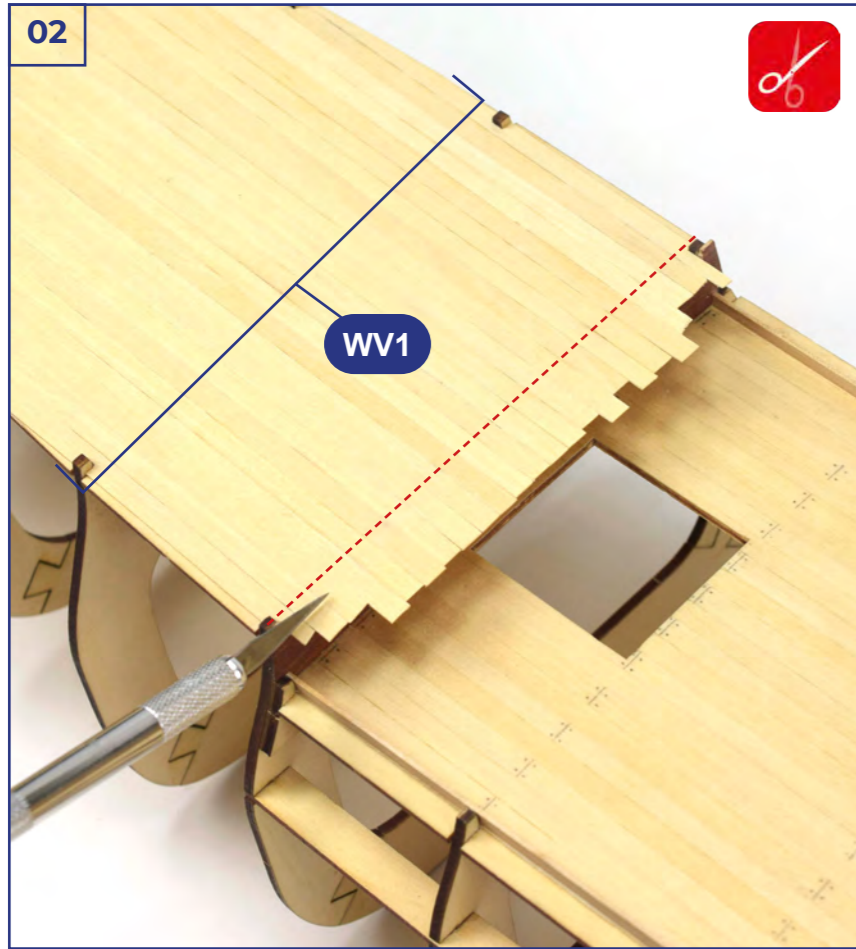

05

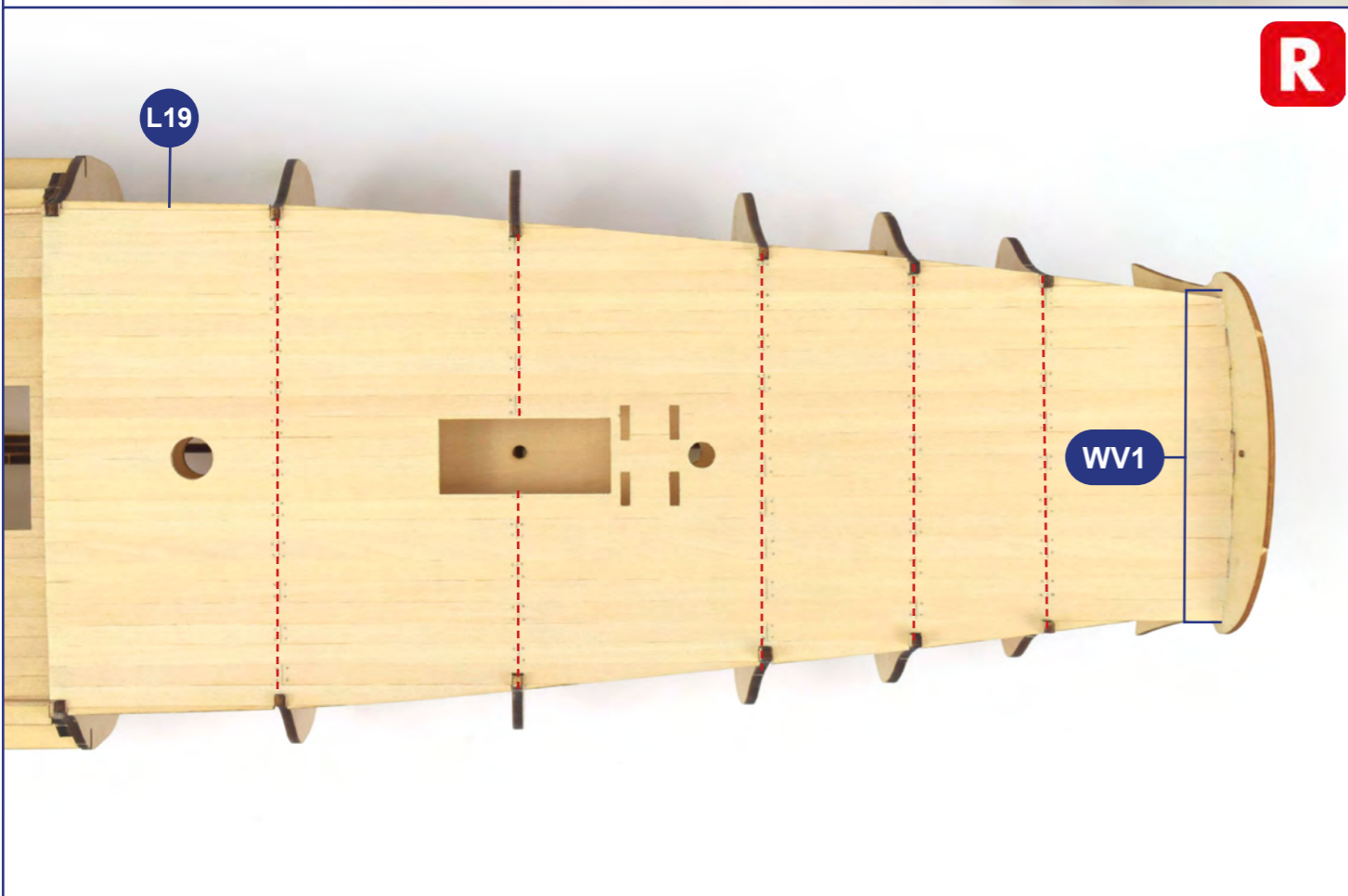
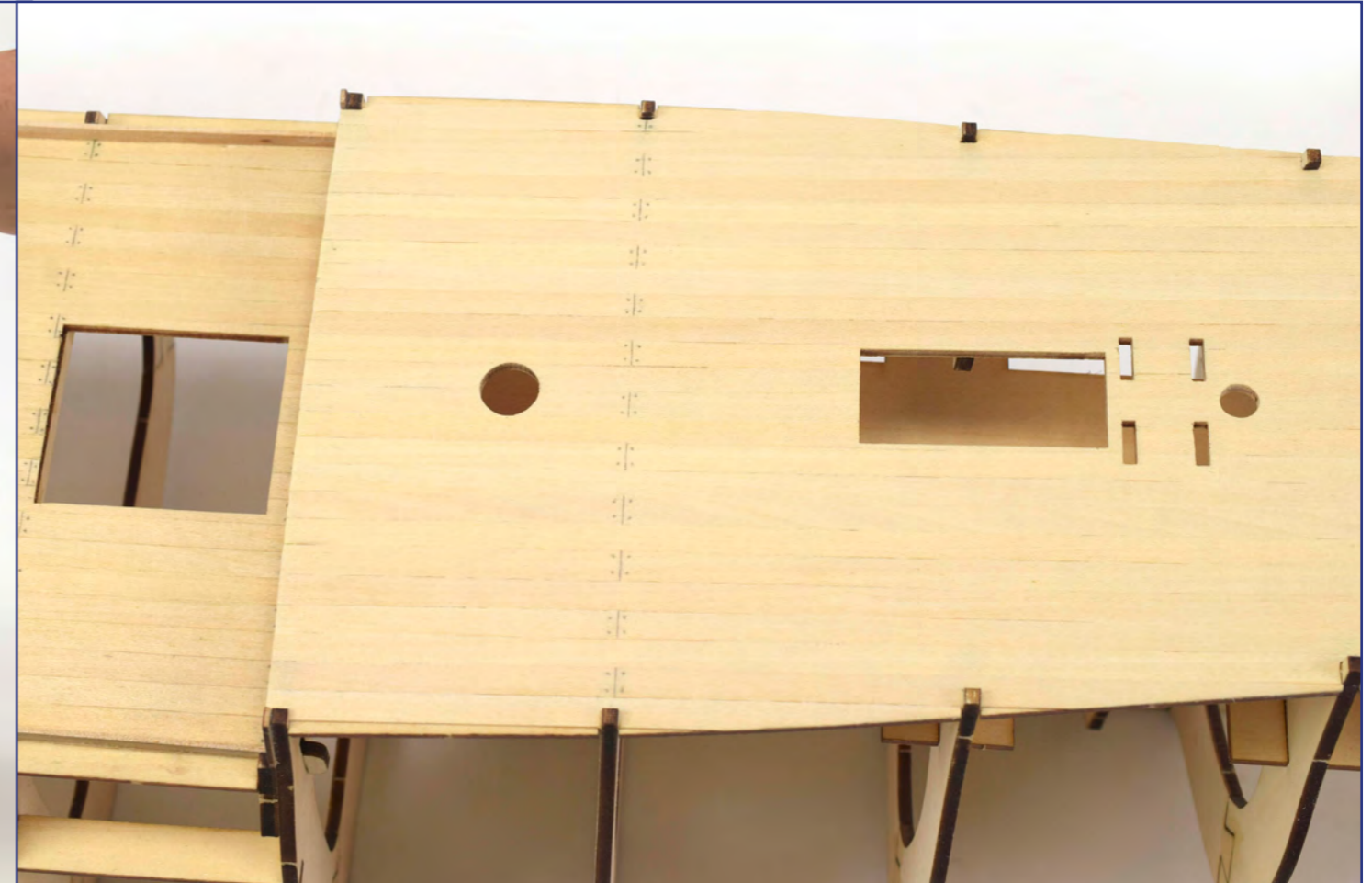
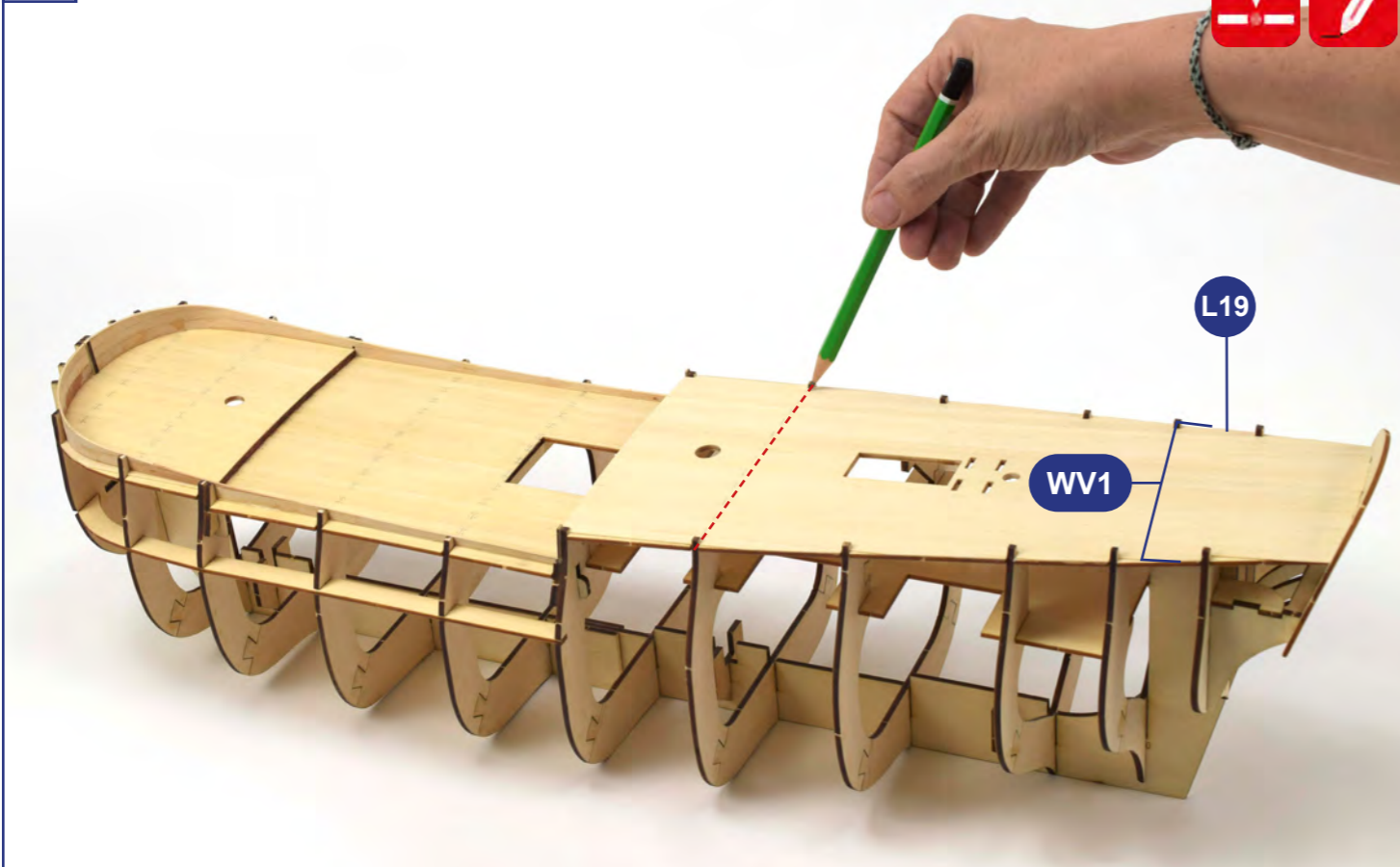

R



06

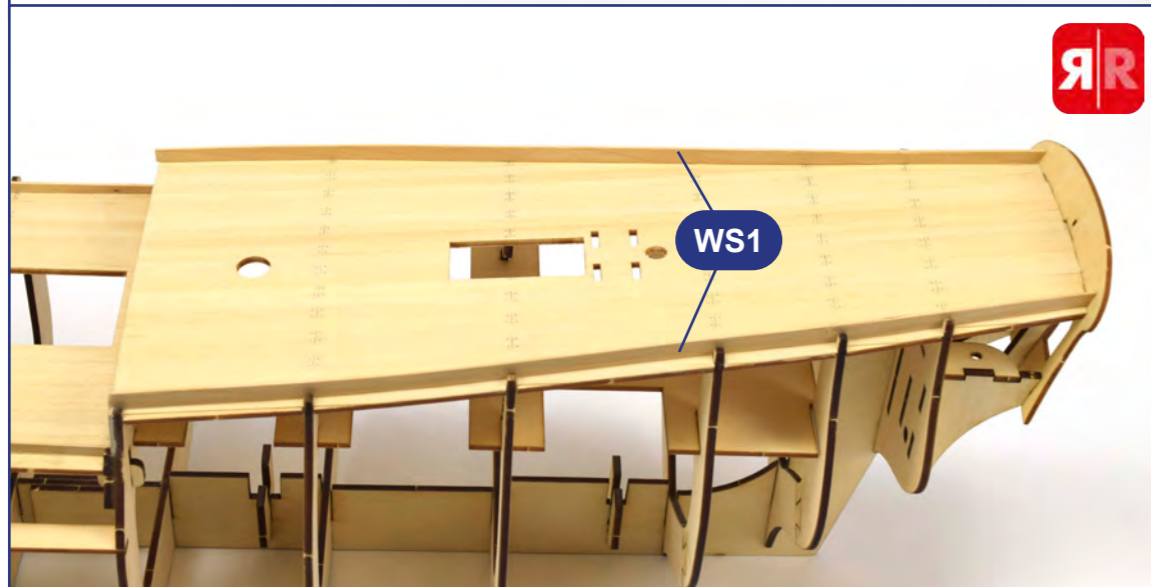
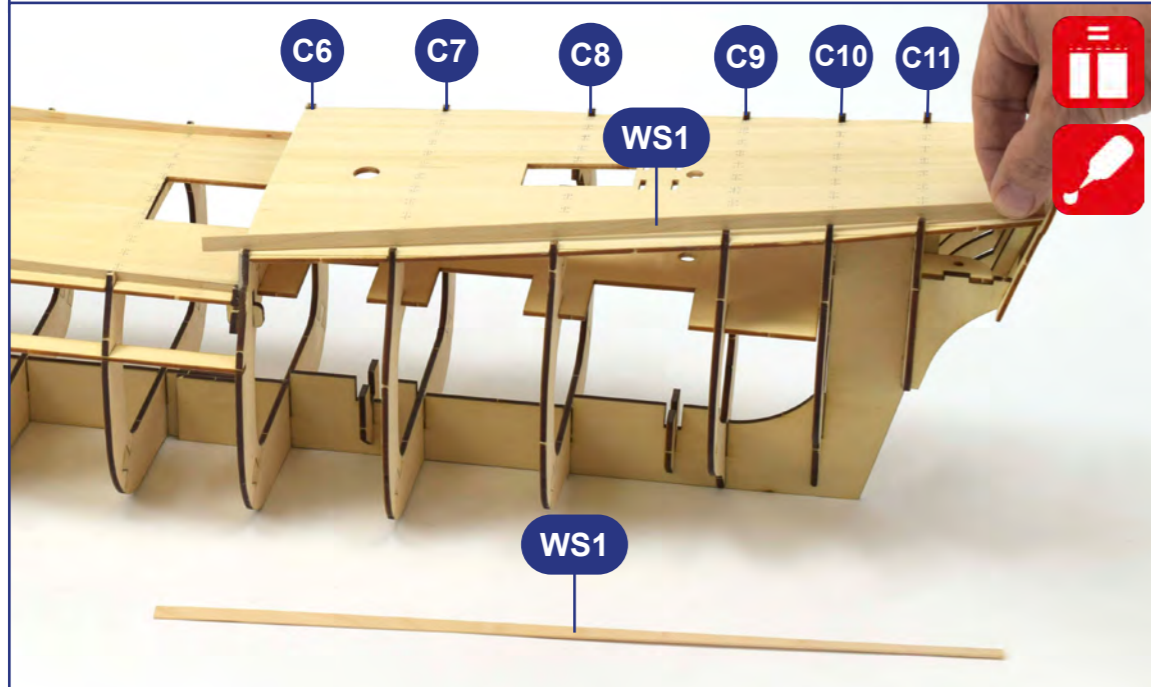
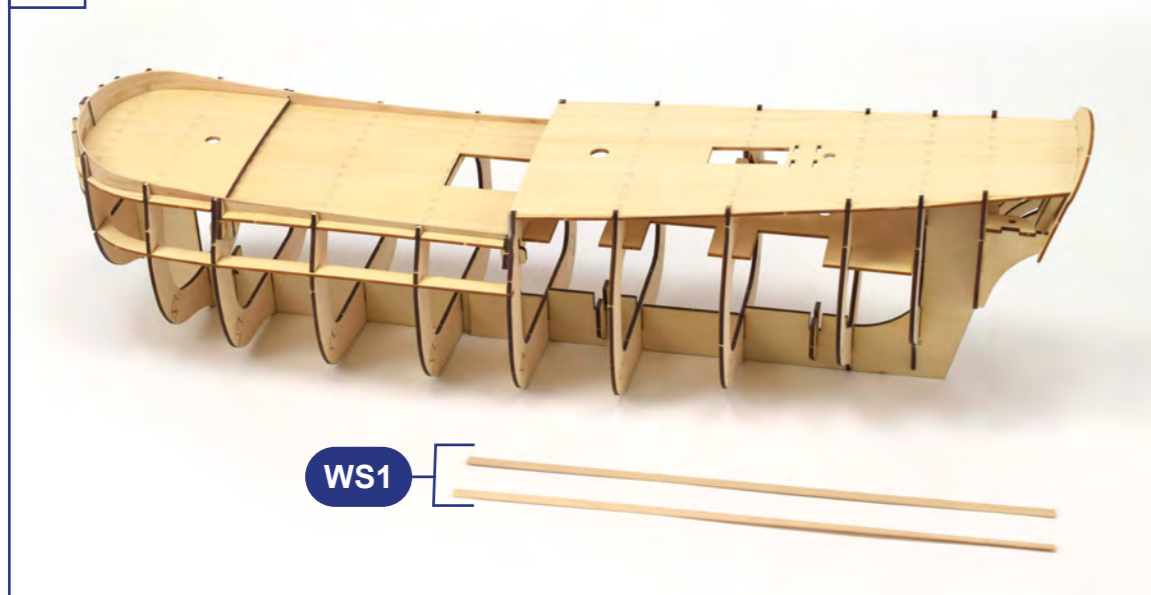

07

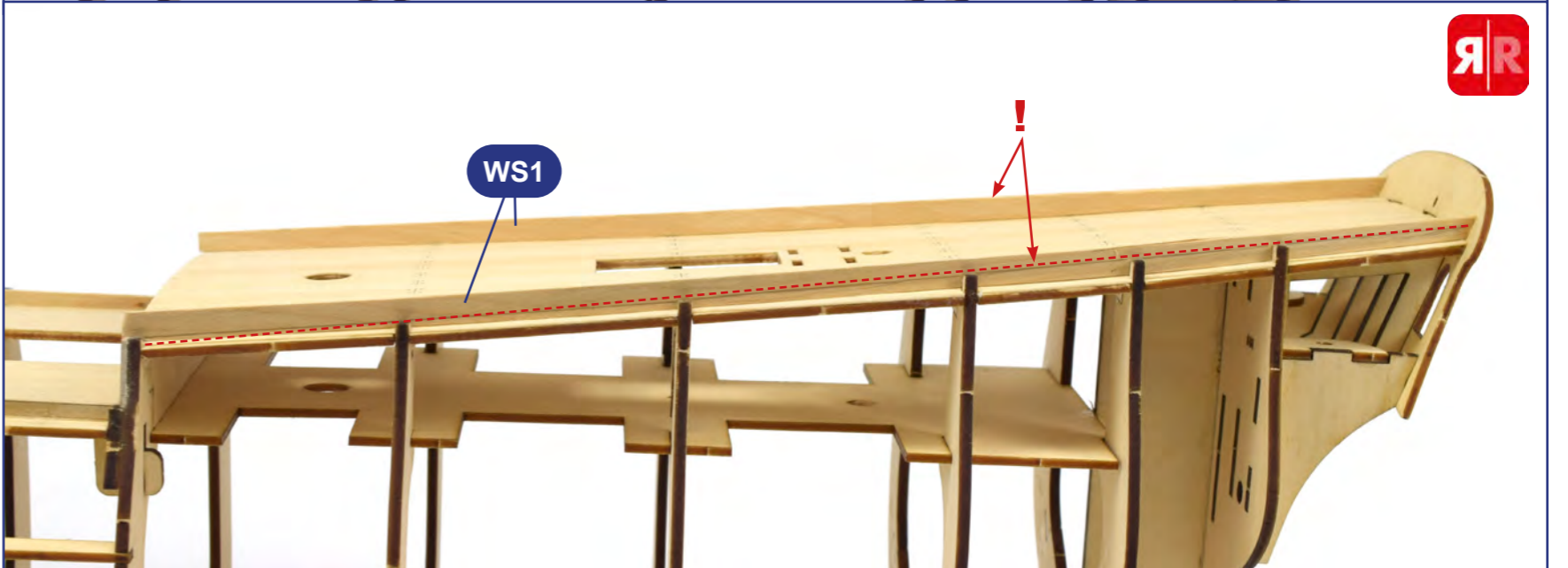
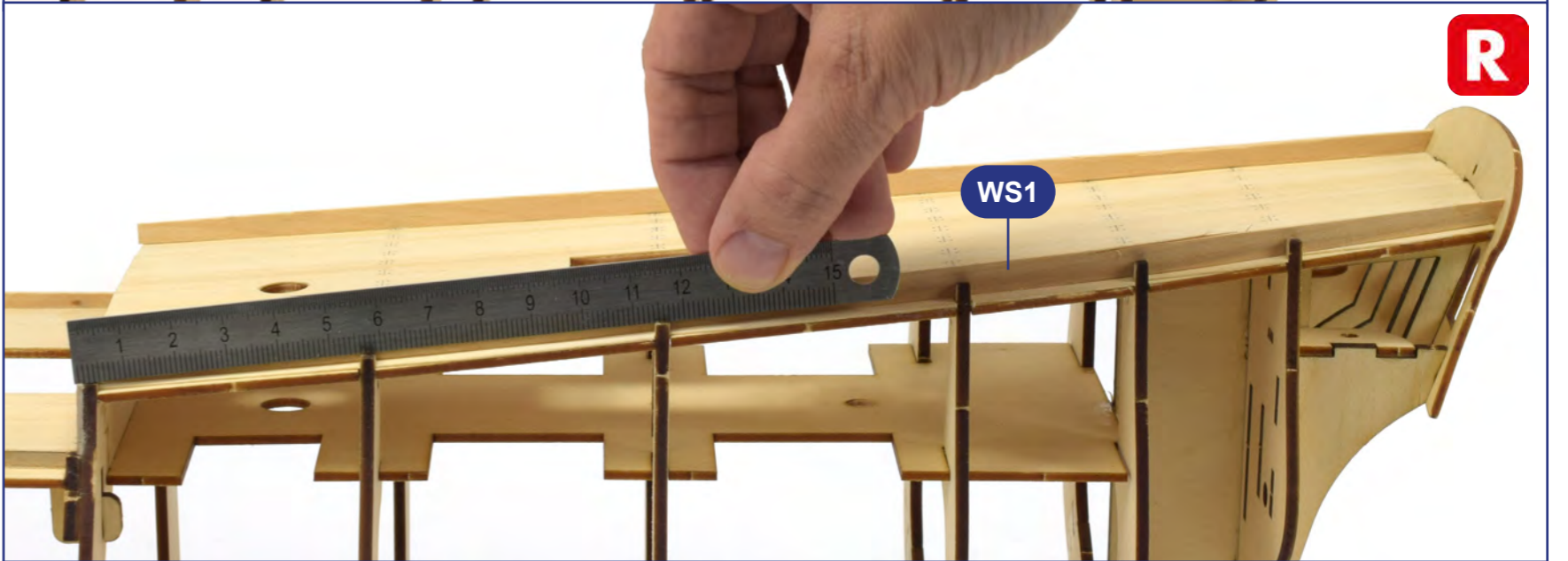
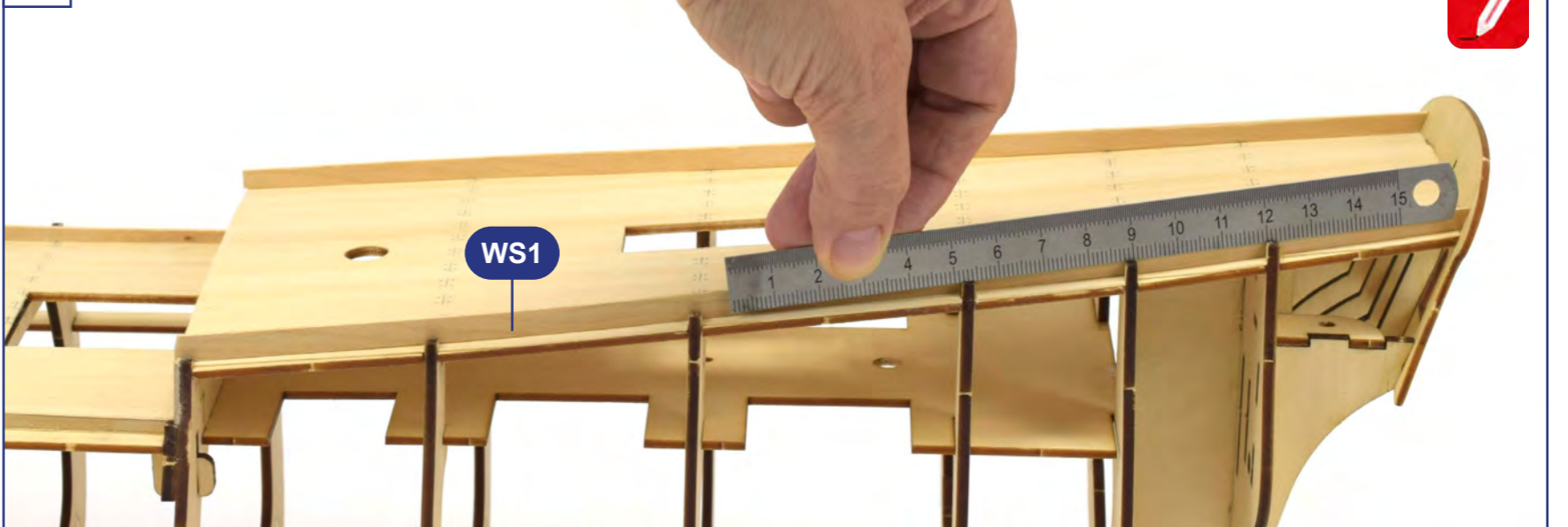

08

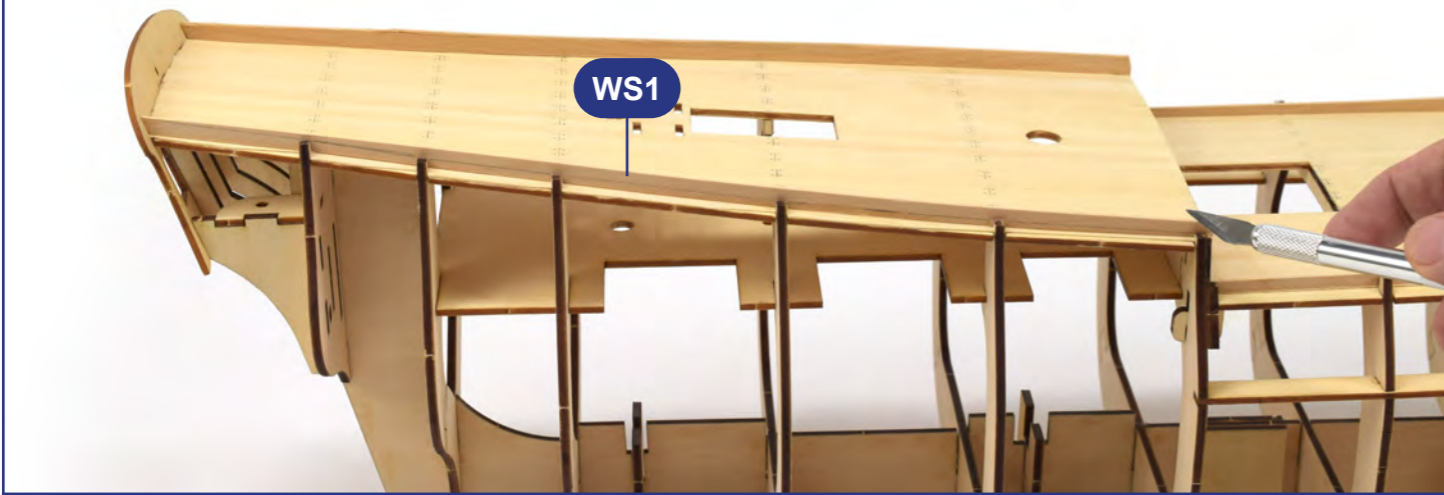

09

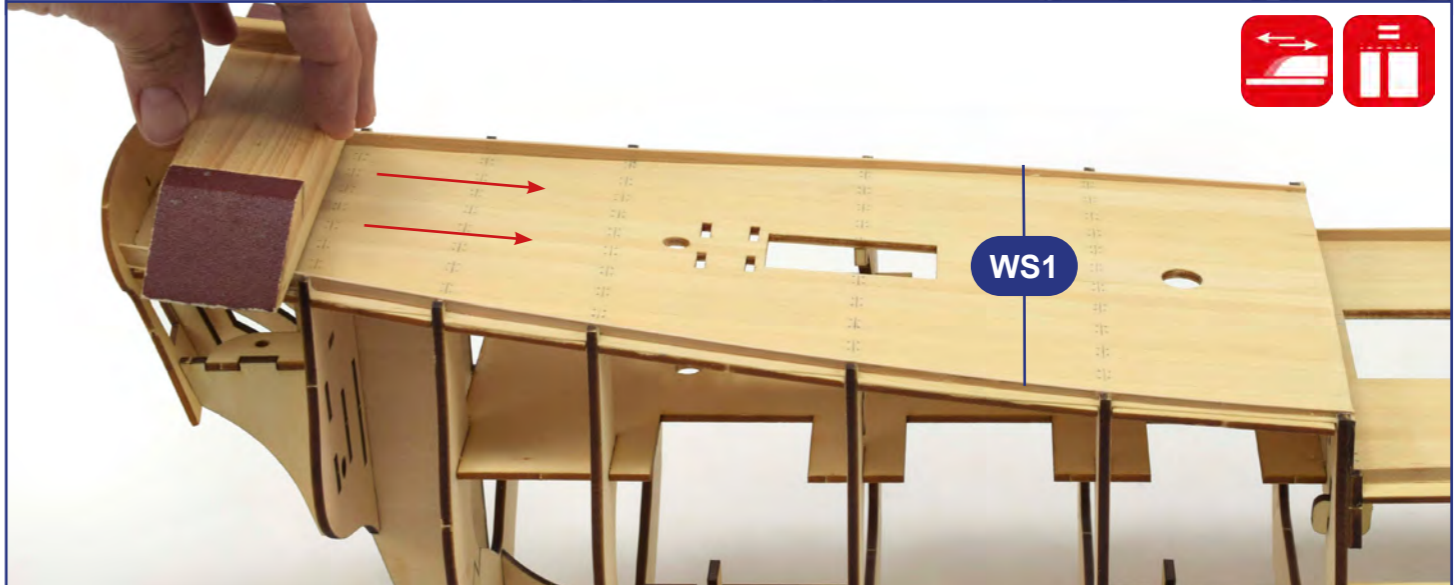
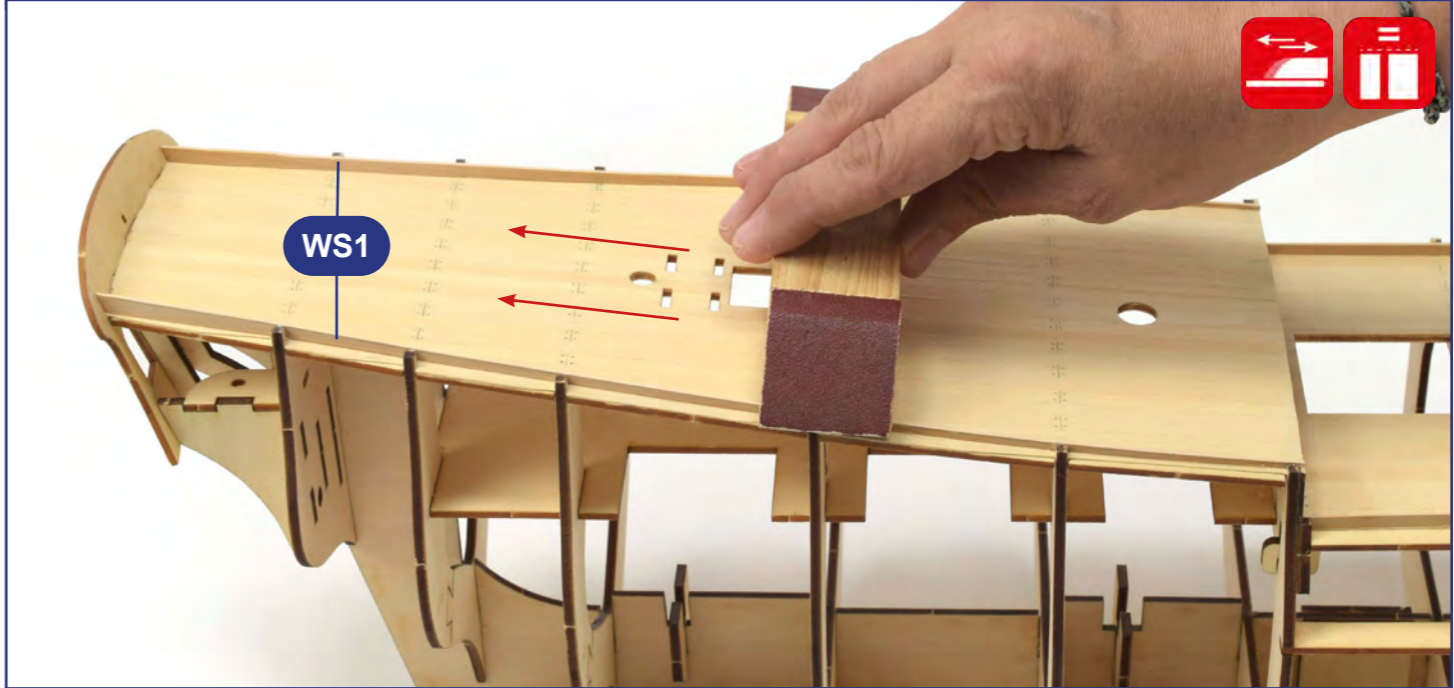
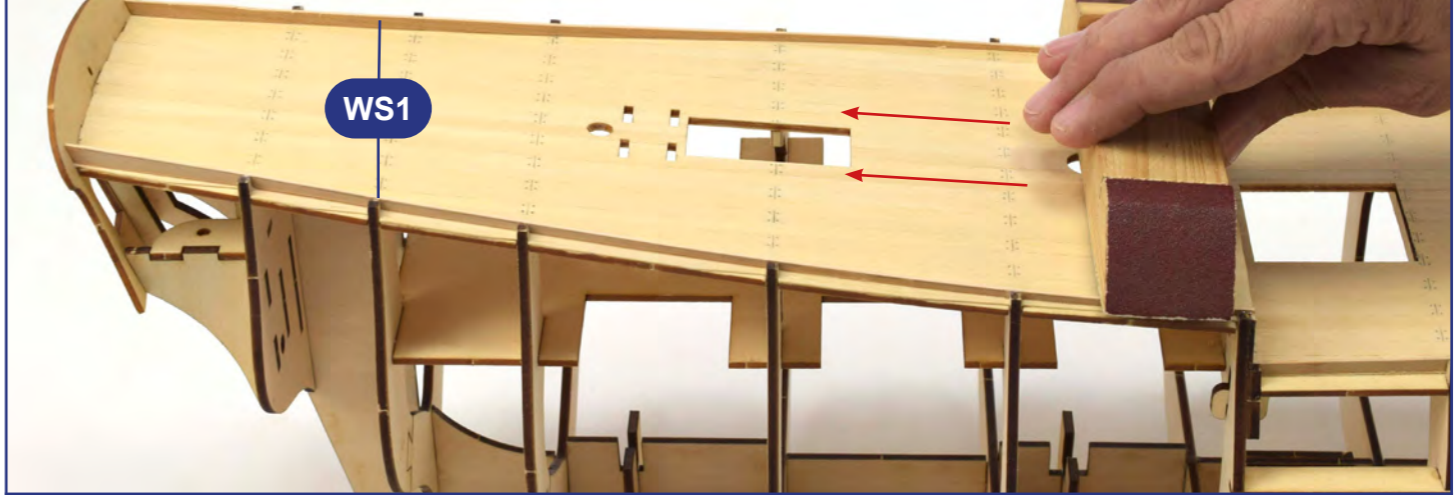

10

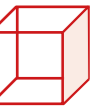

RIGHT
VIEW



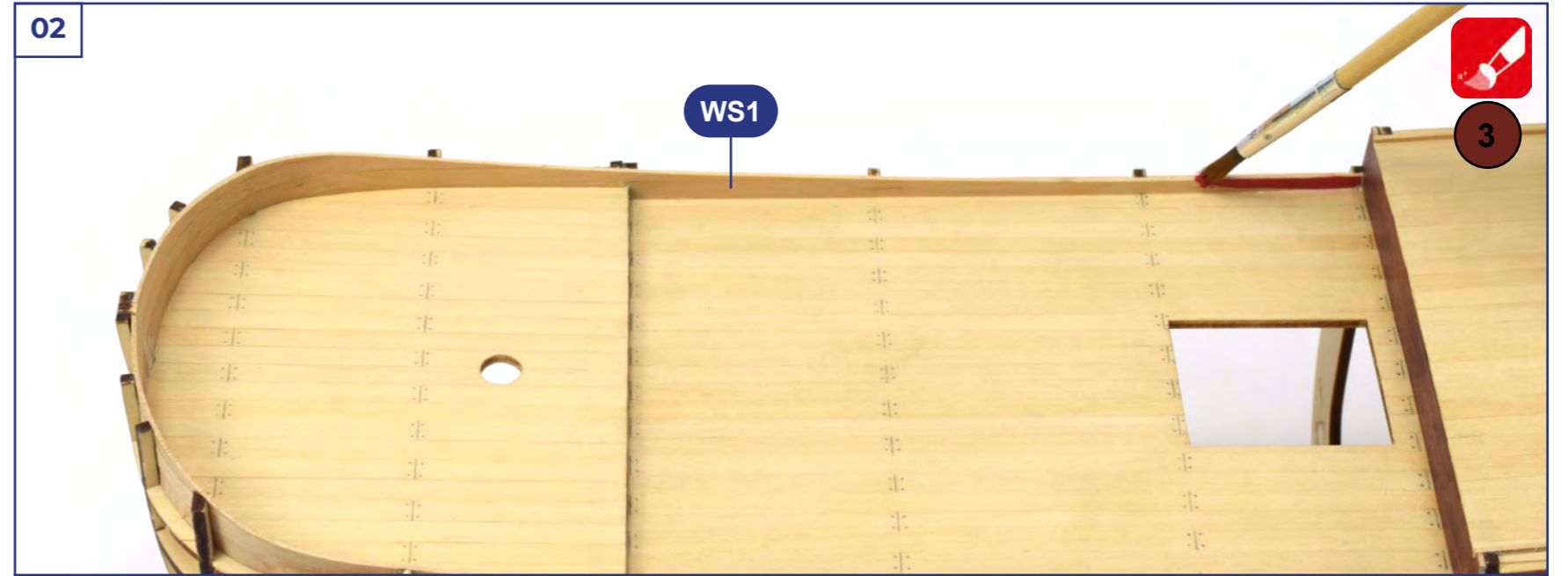

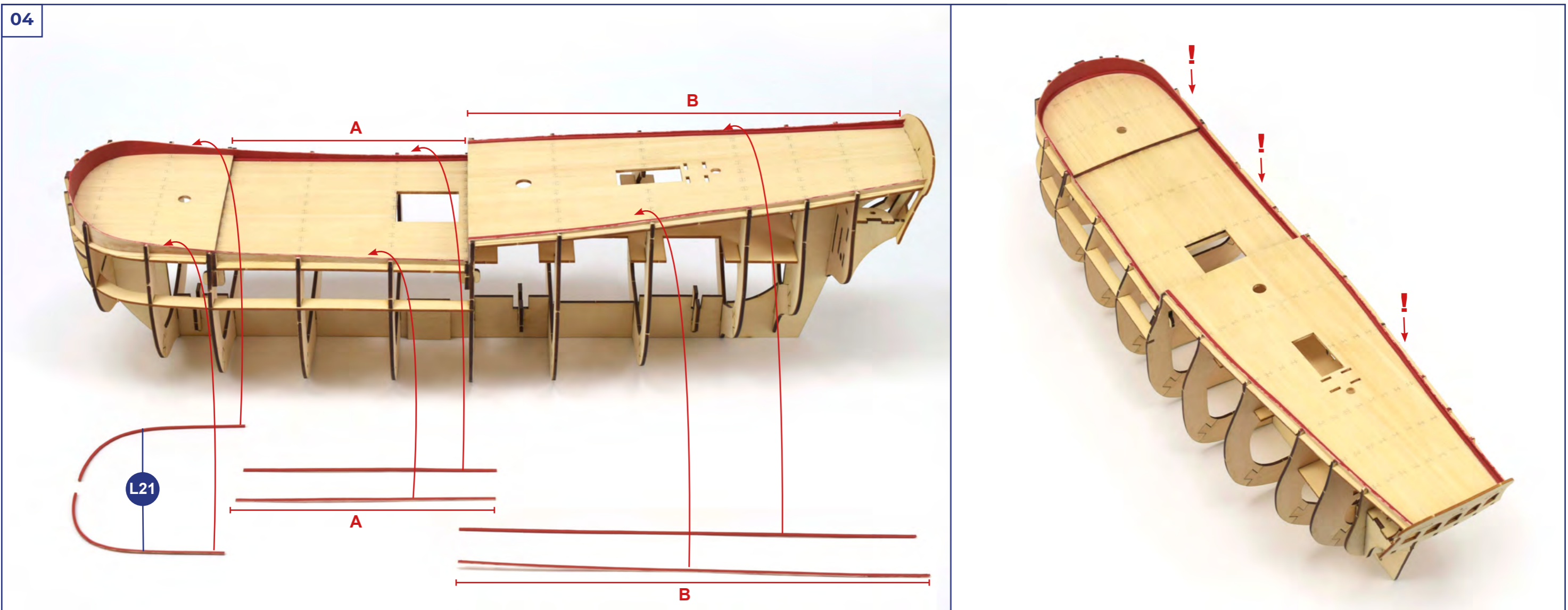
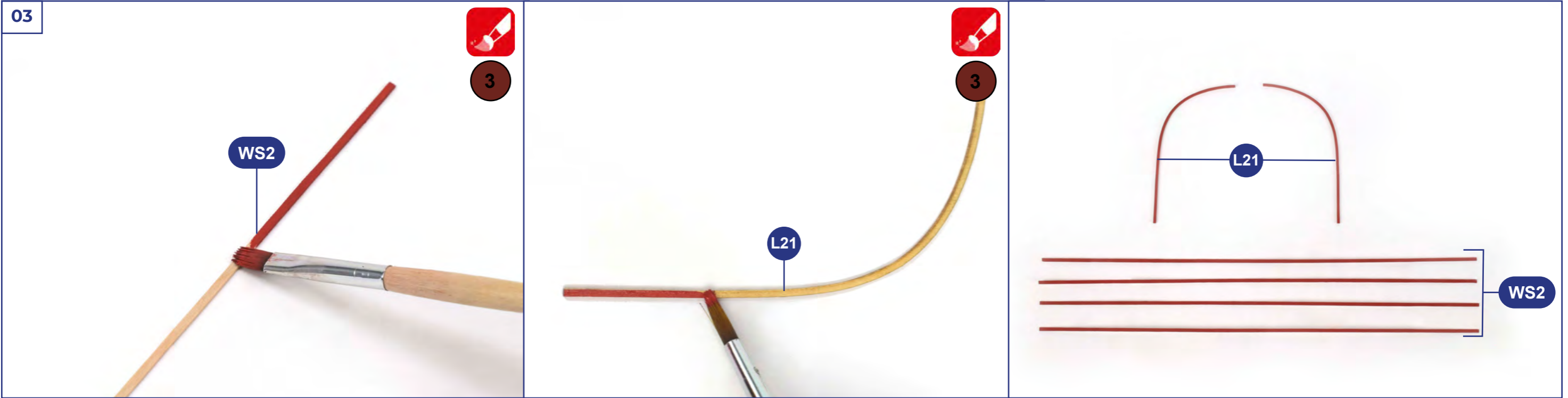

05

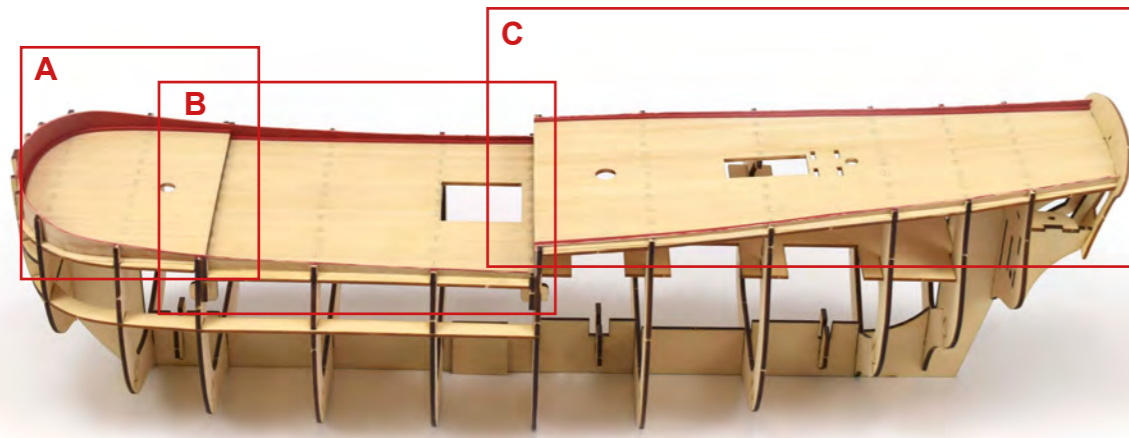

B

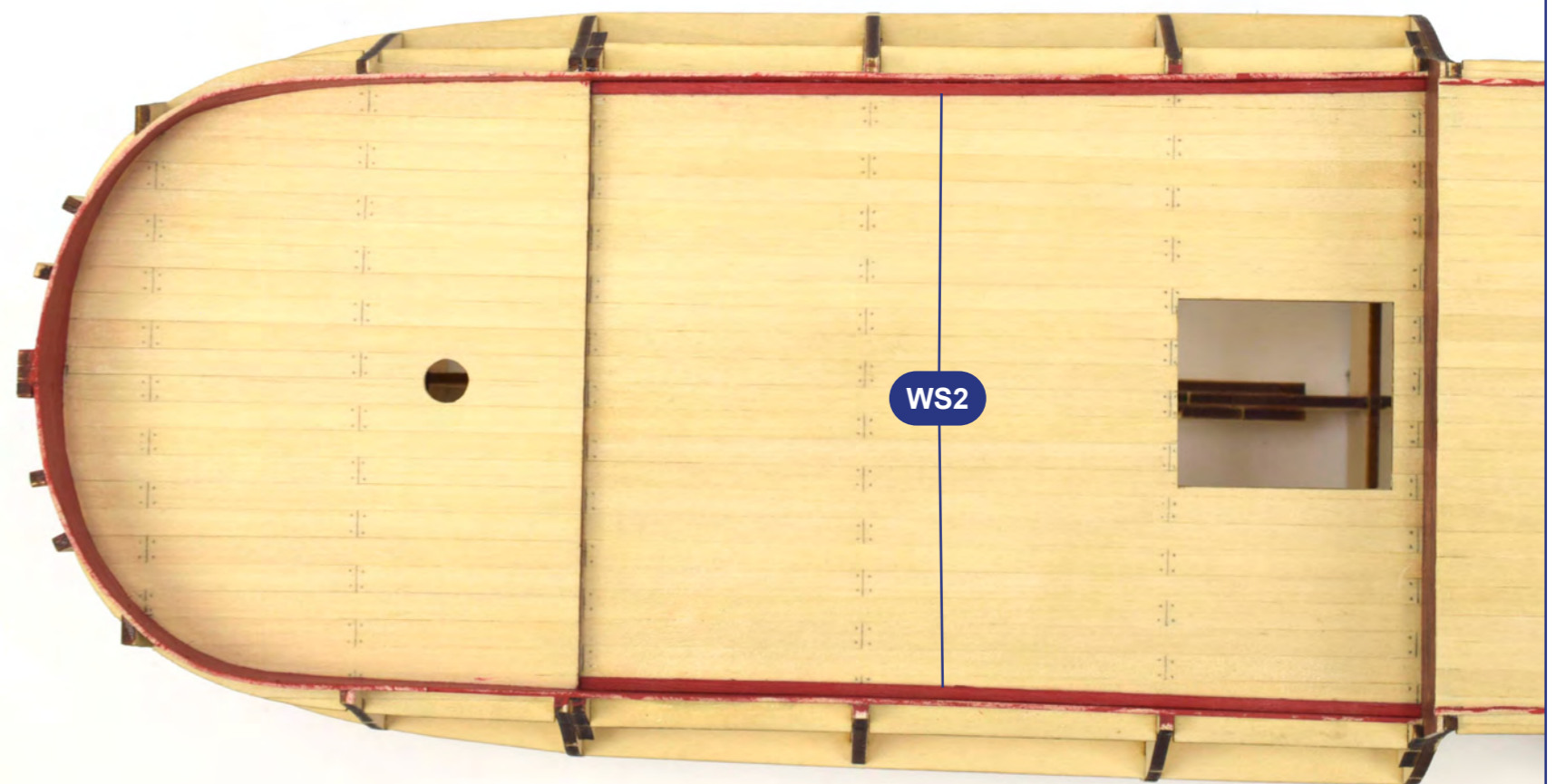

A



C

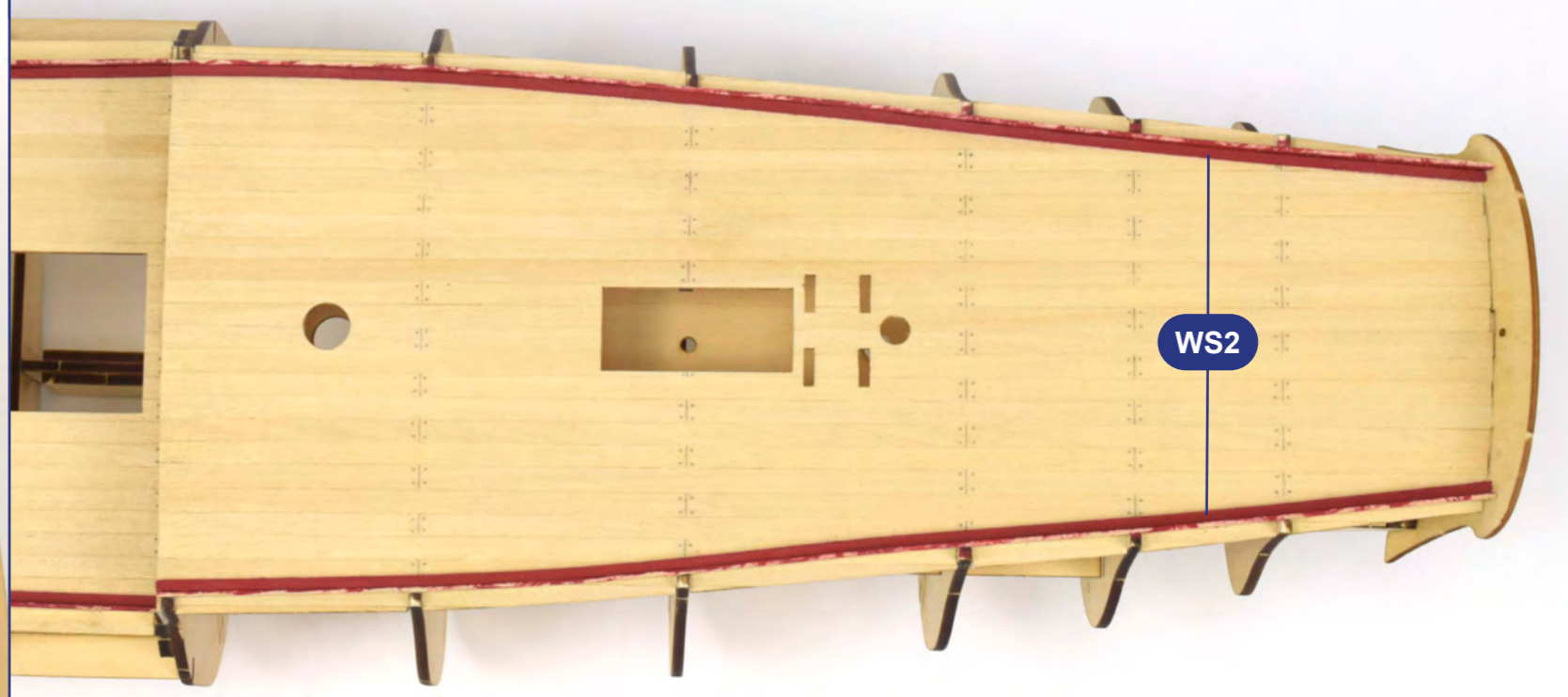

06

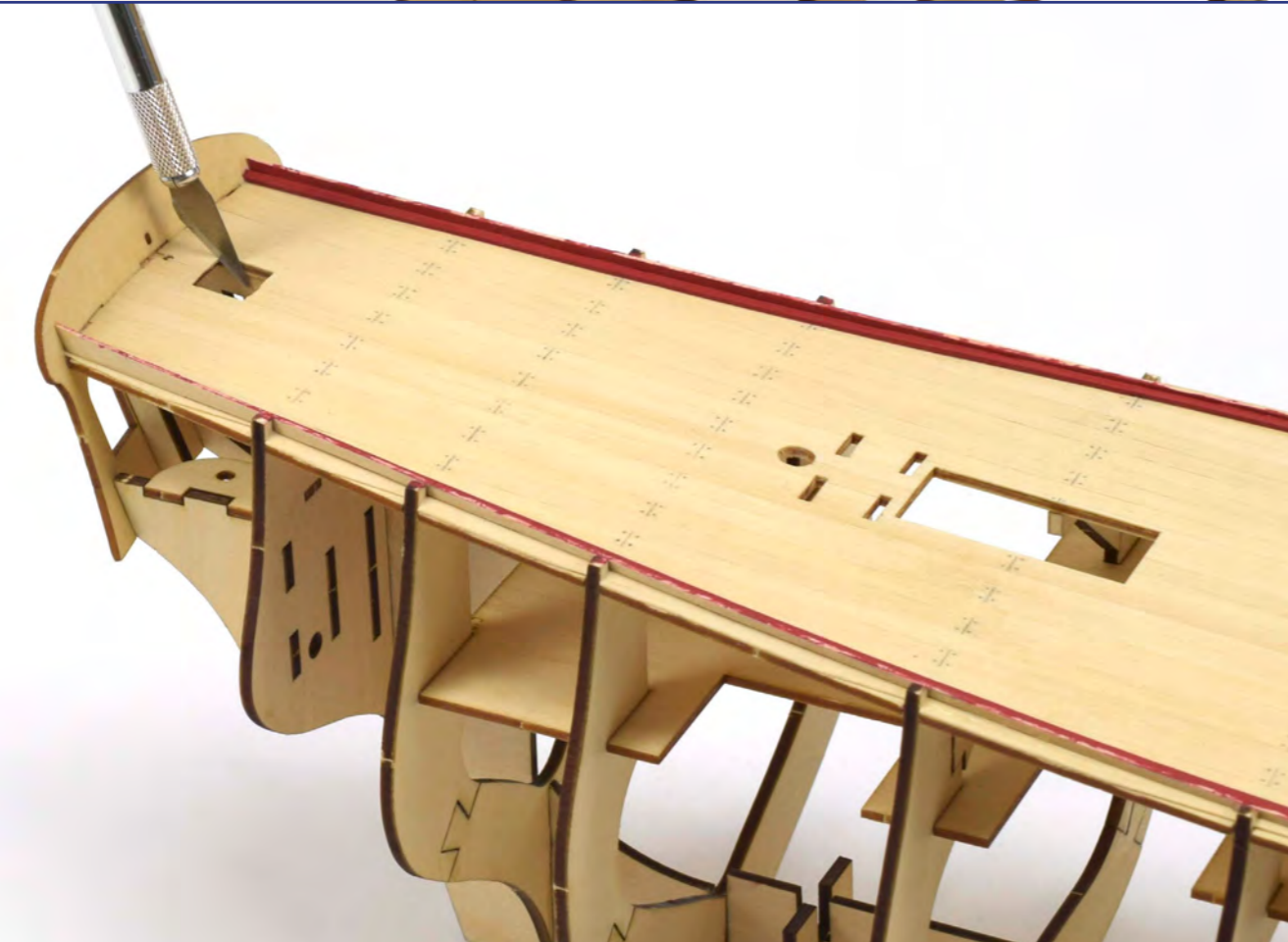

07

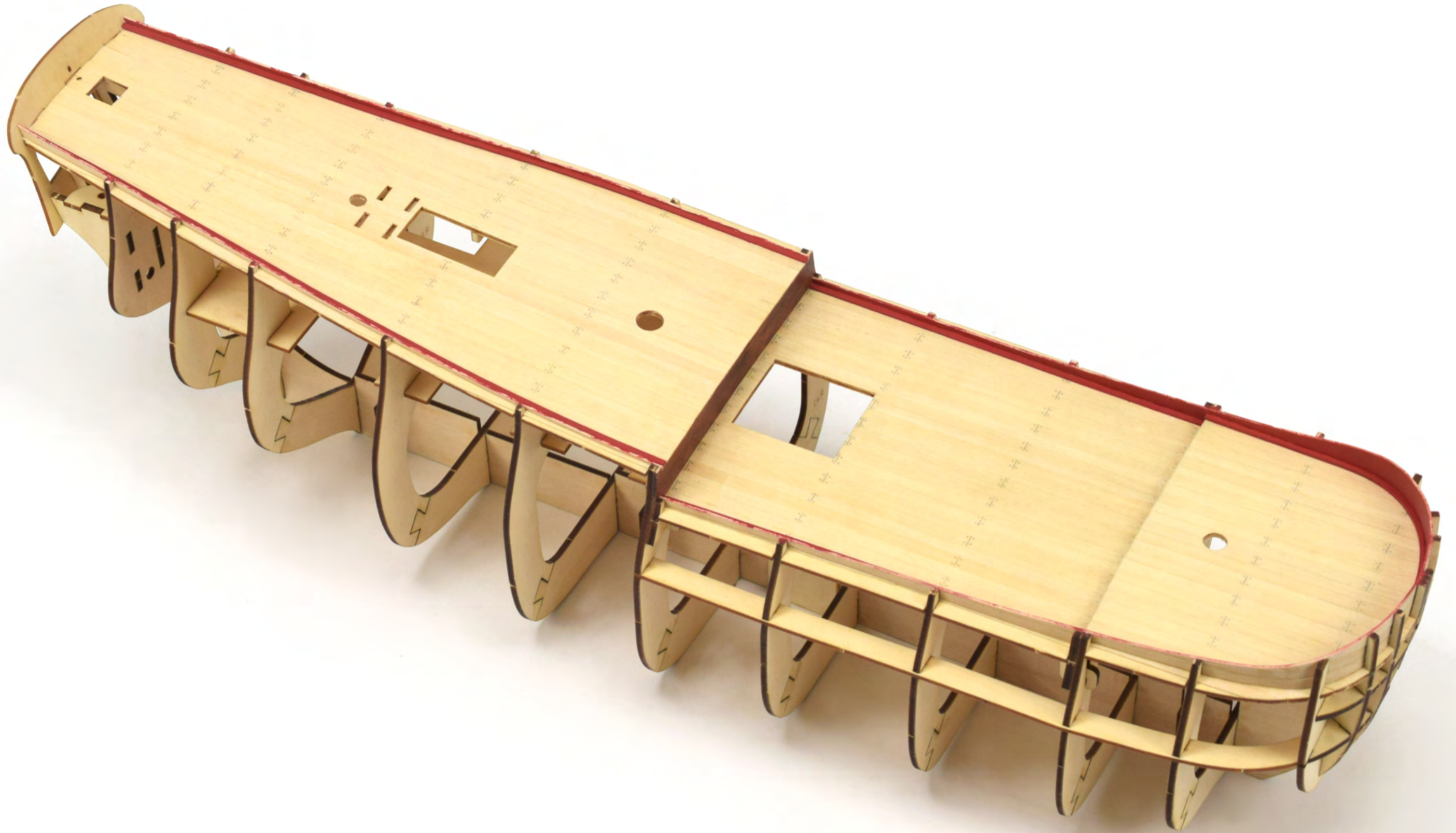

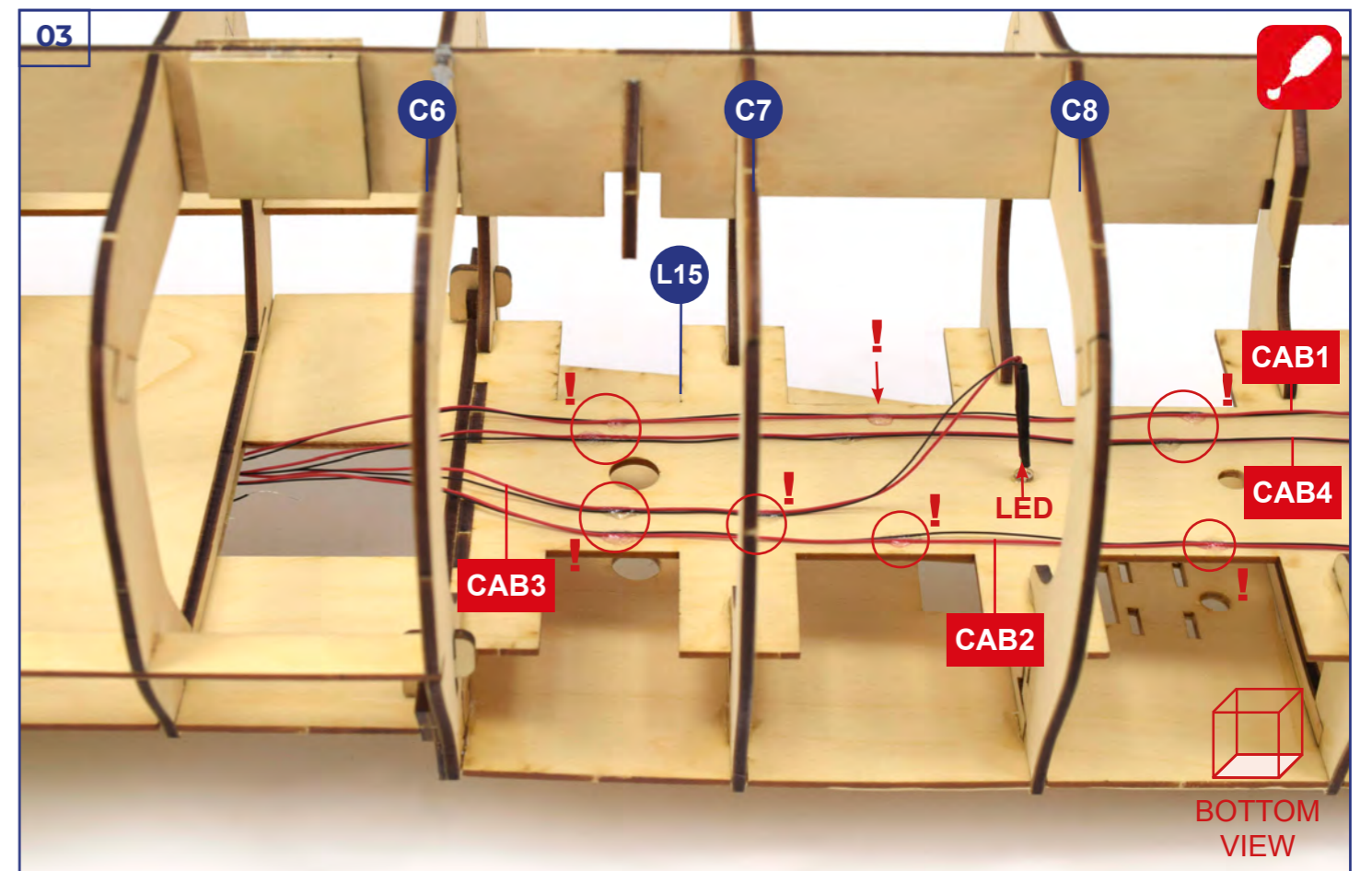
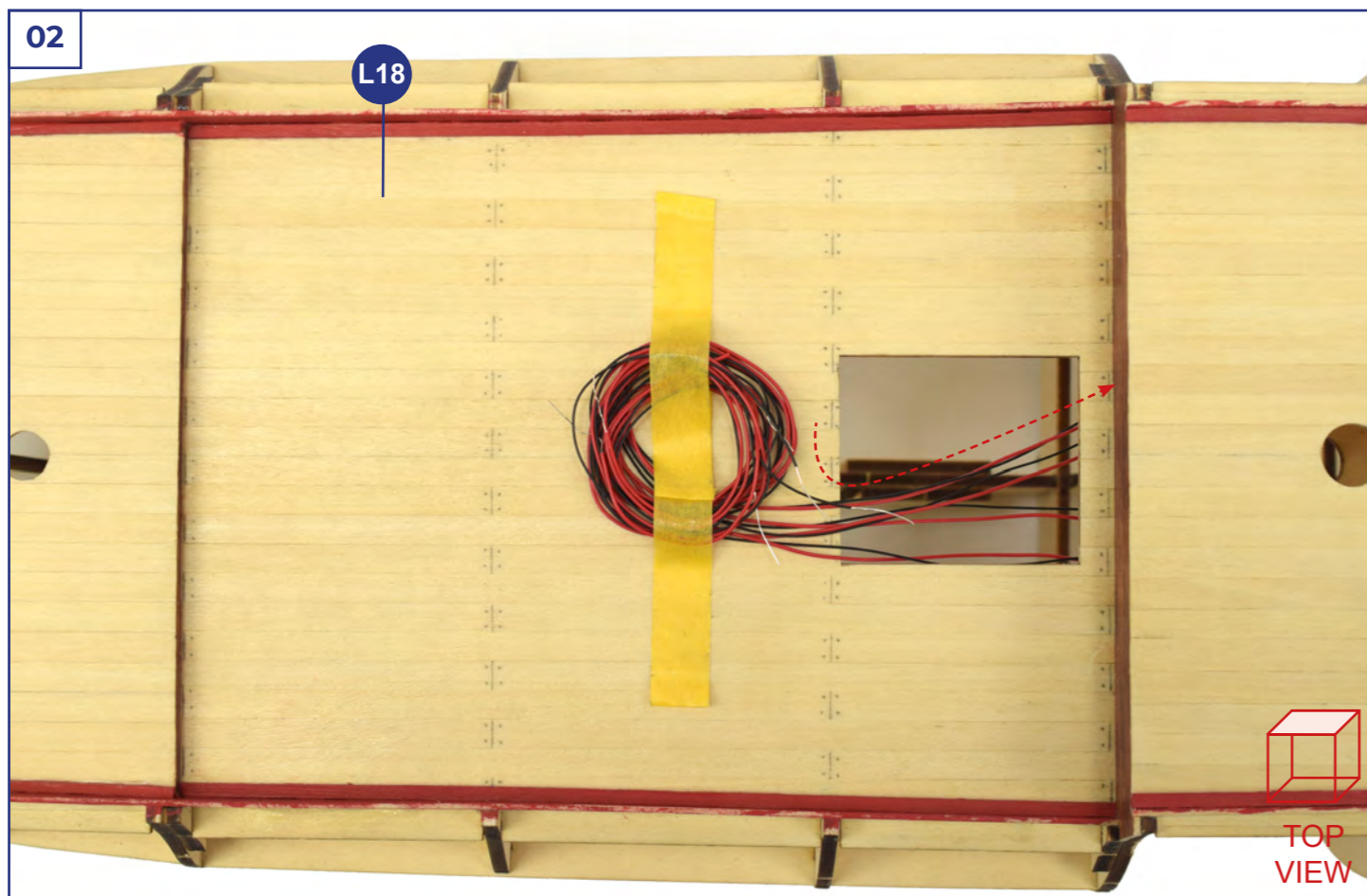
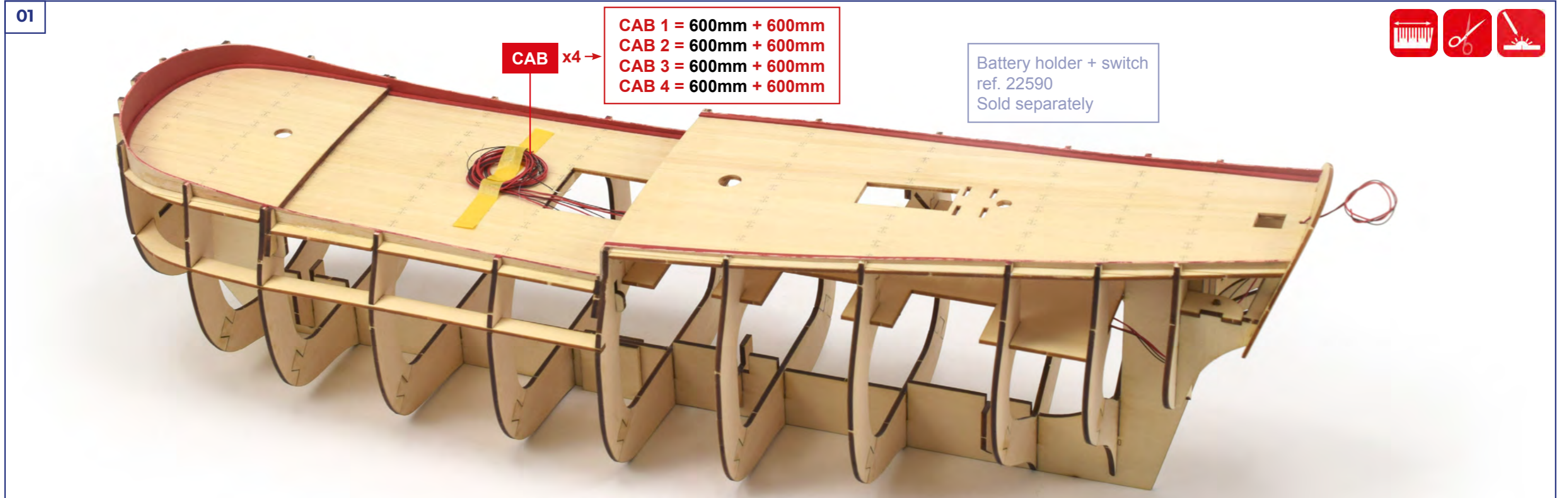

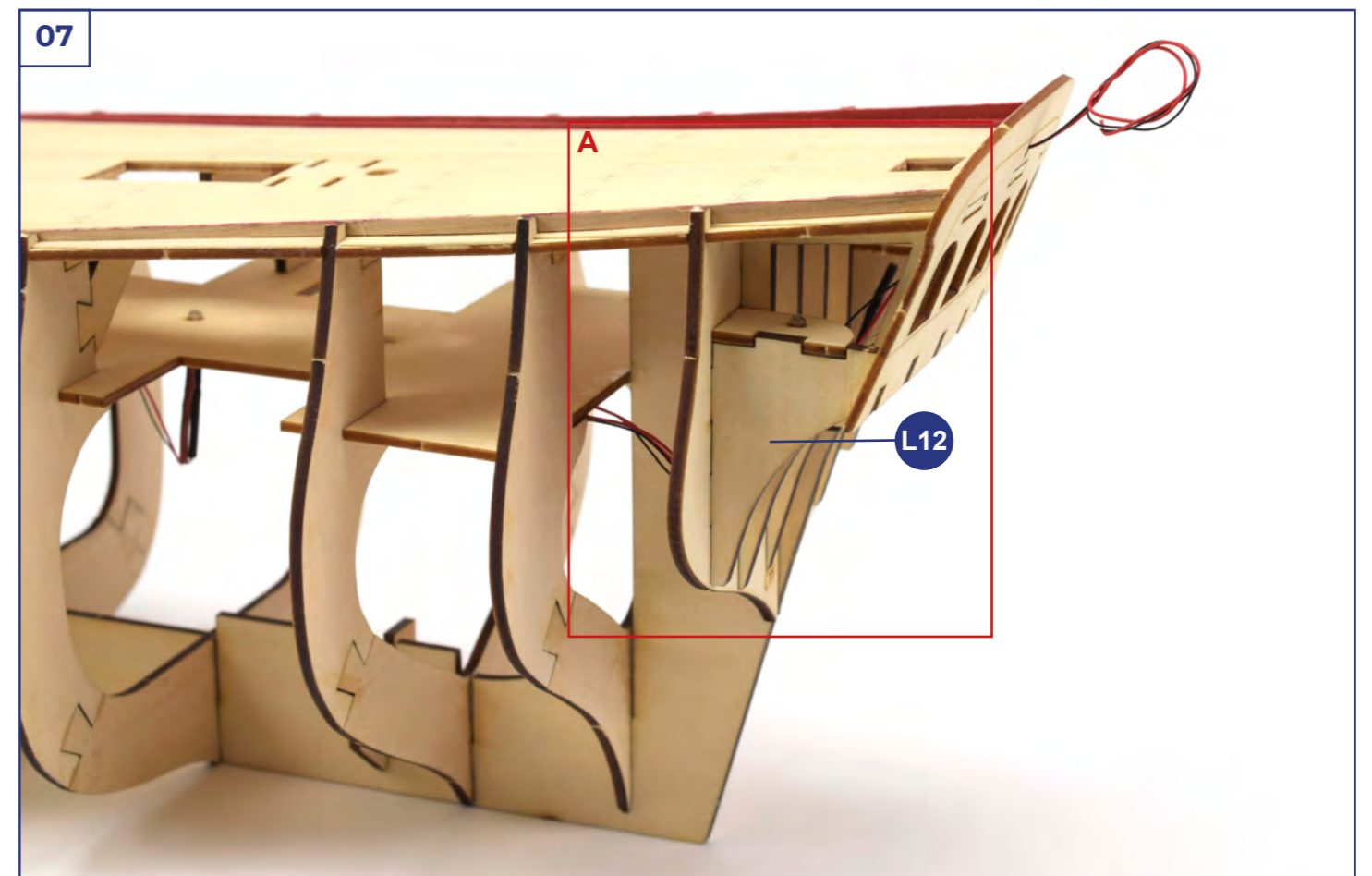
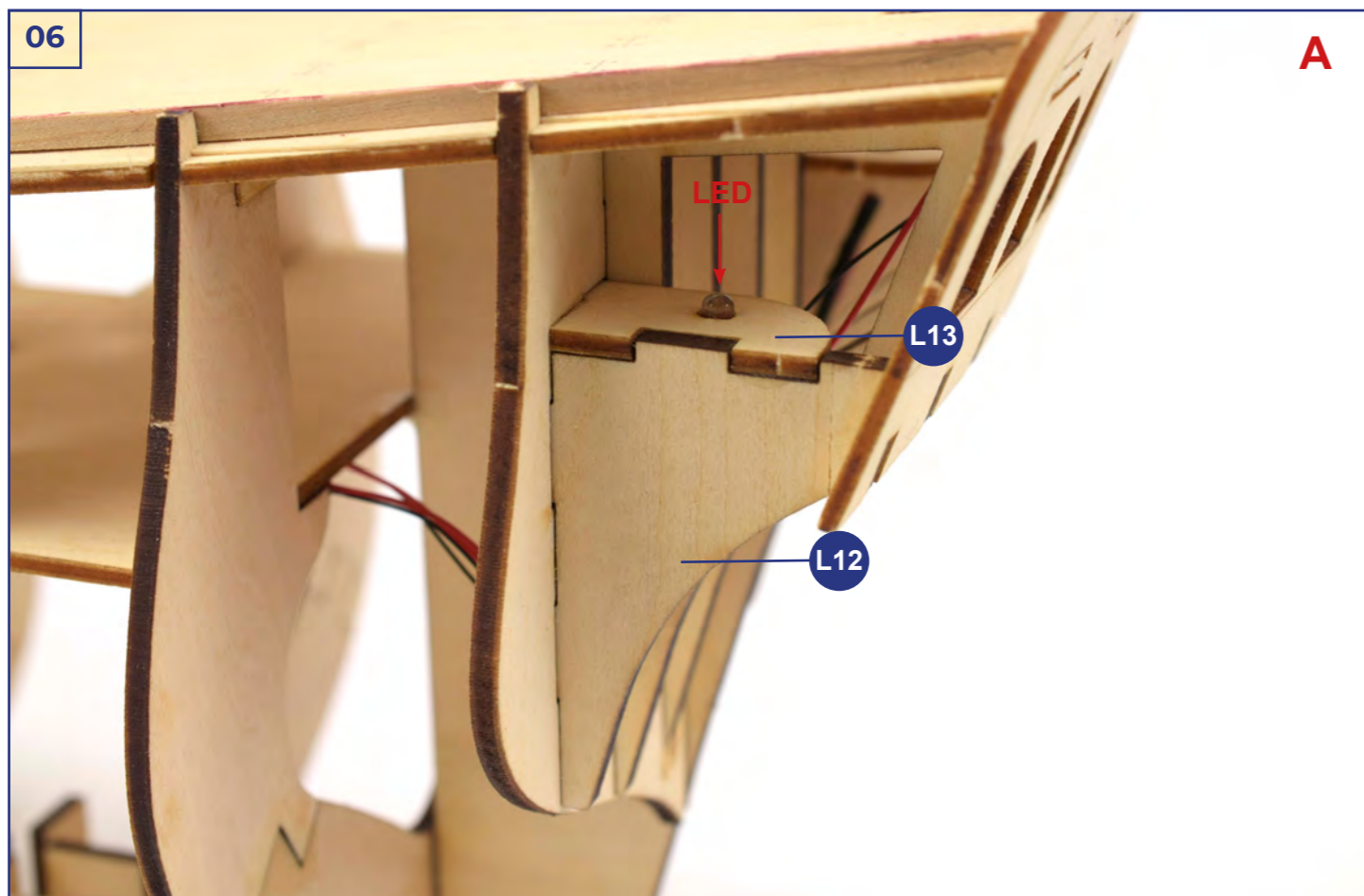
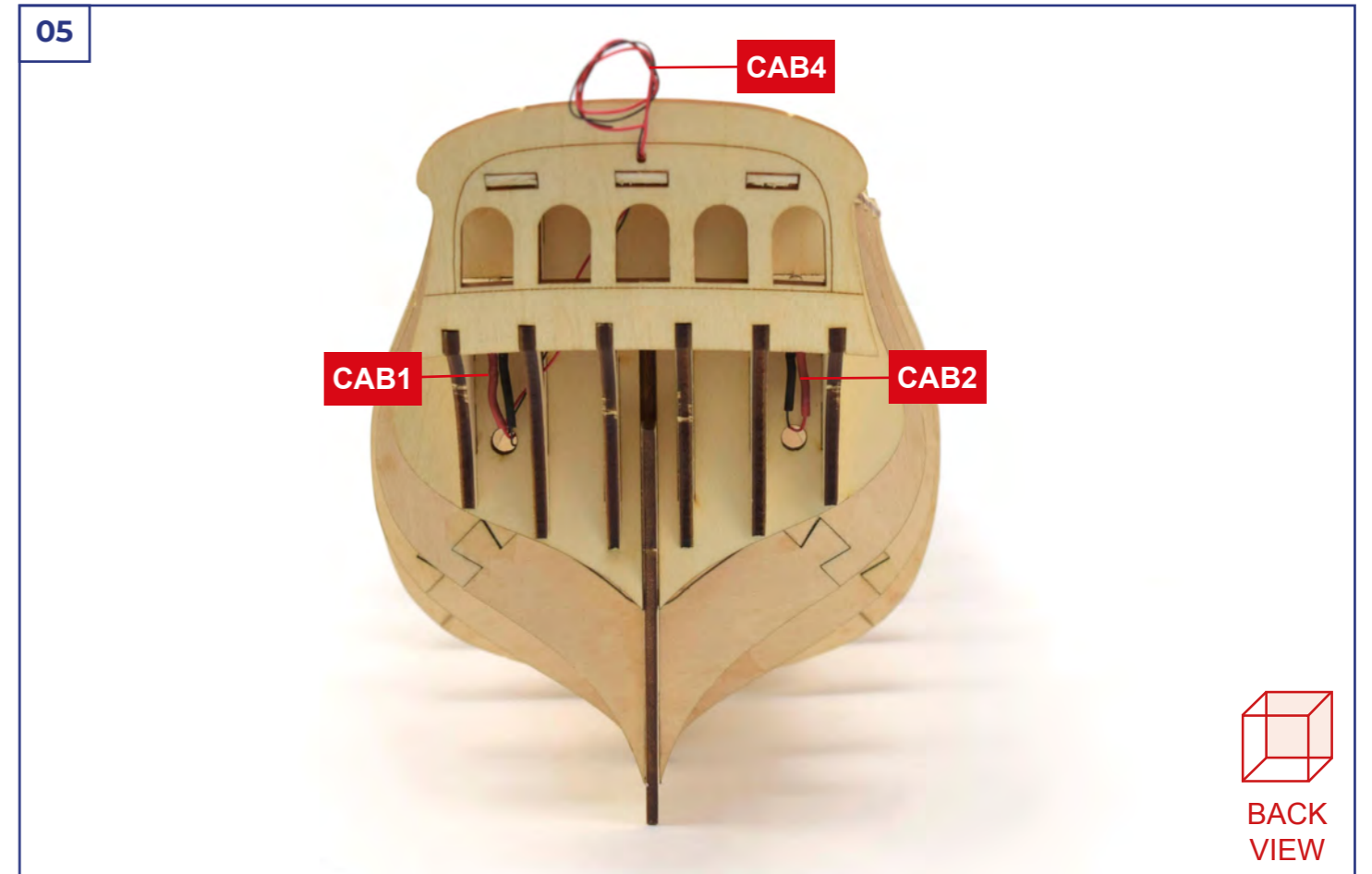
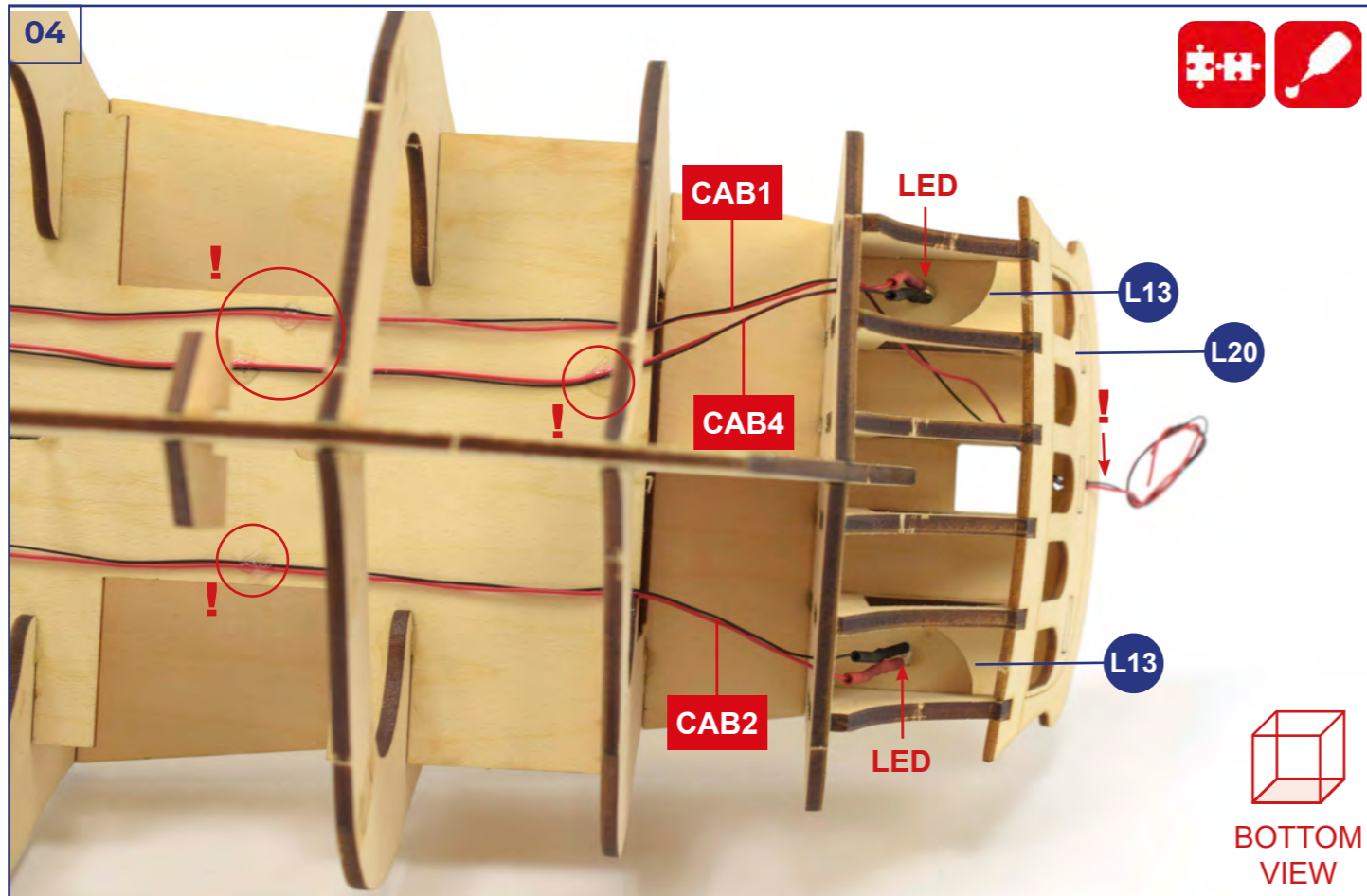

01

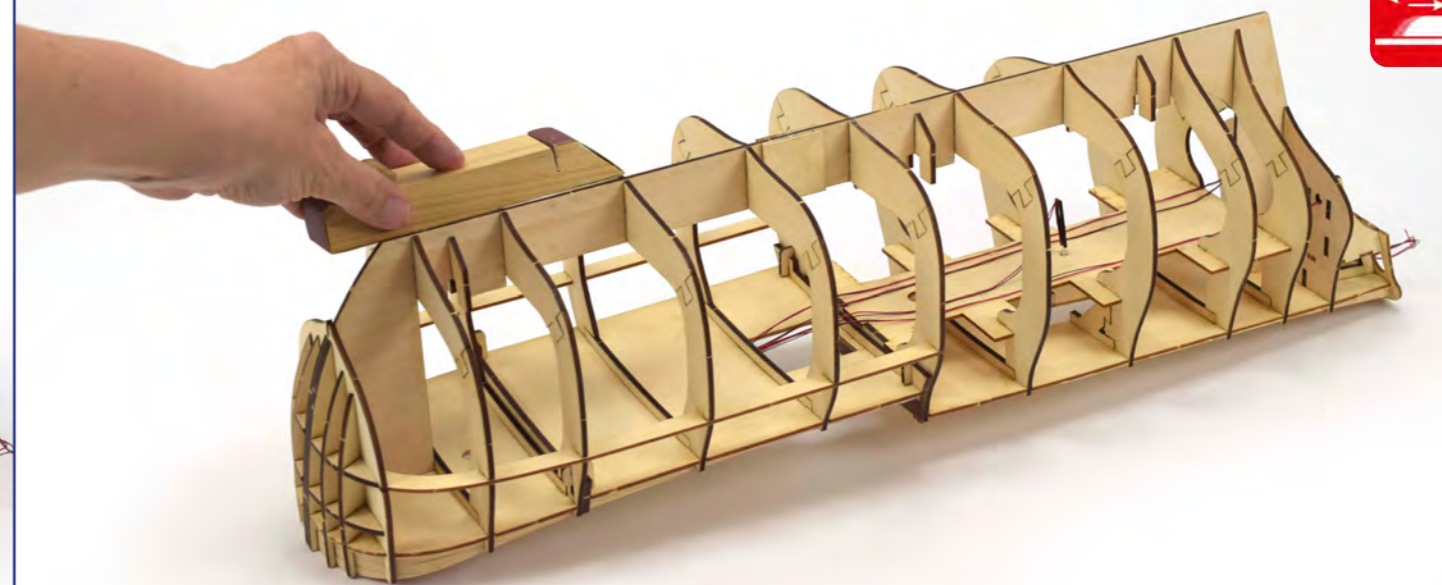
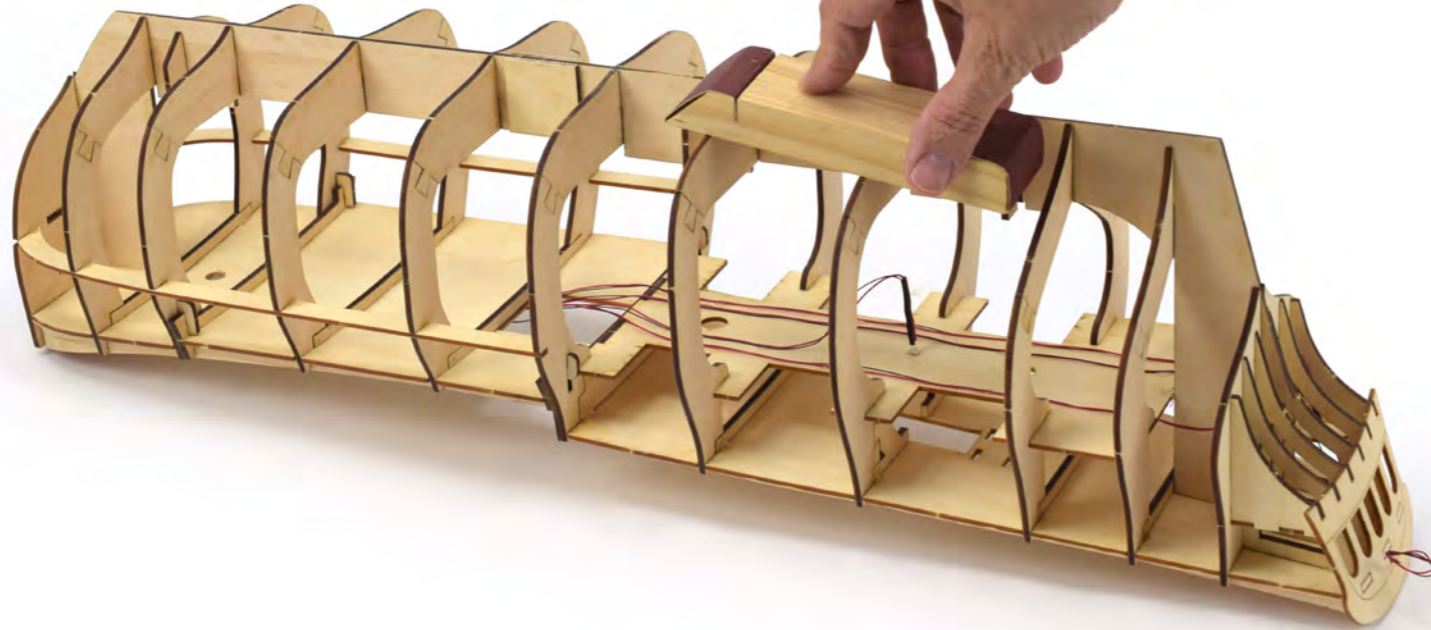
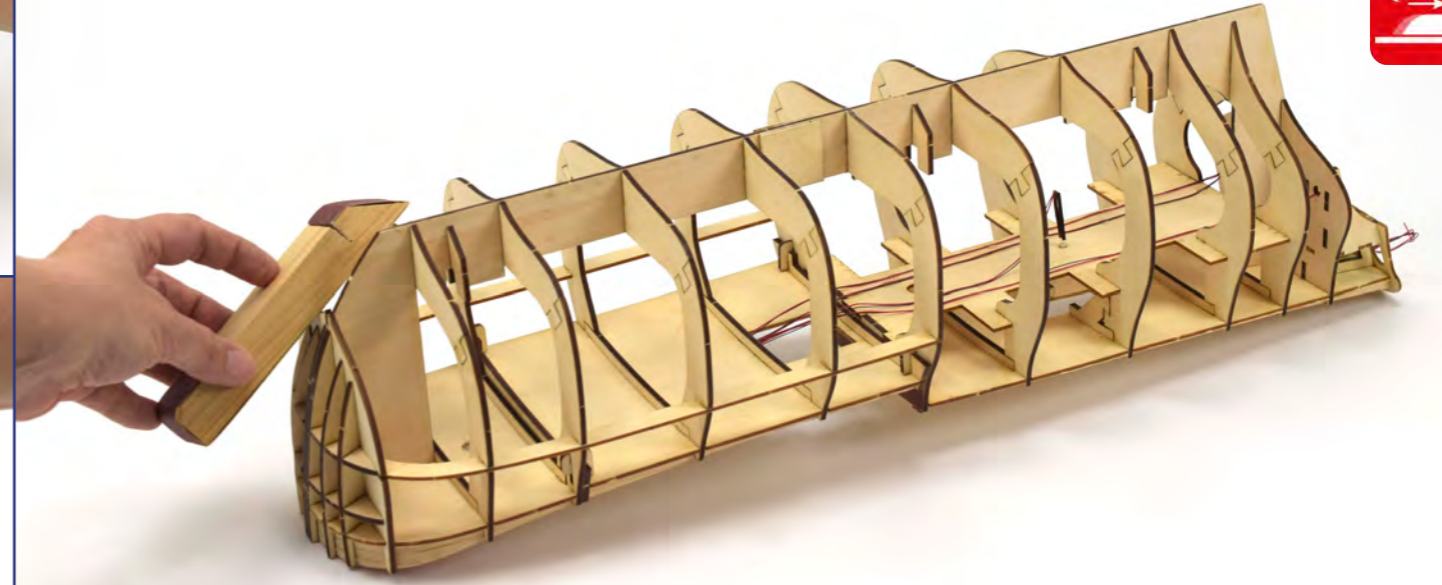
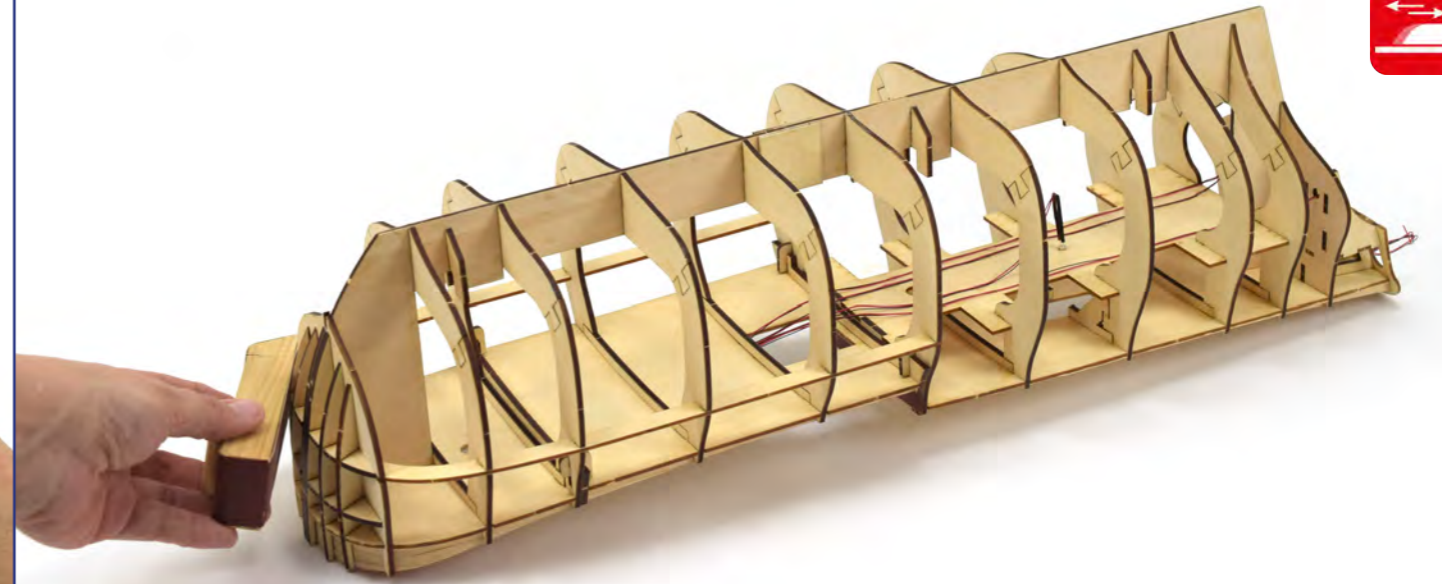

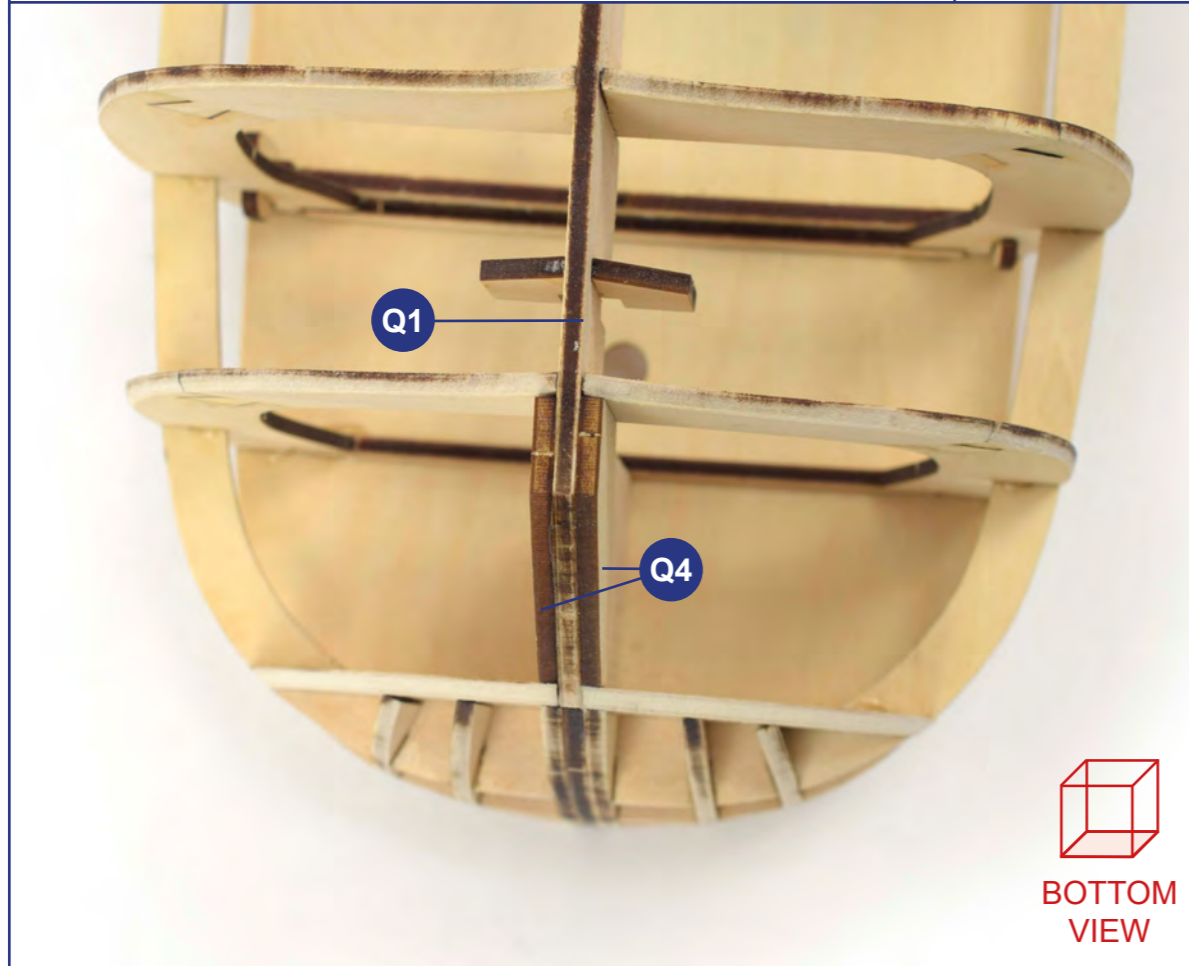
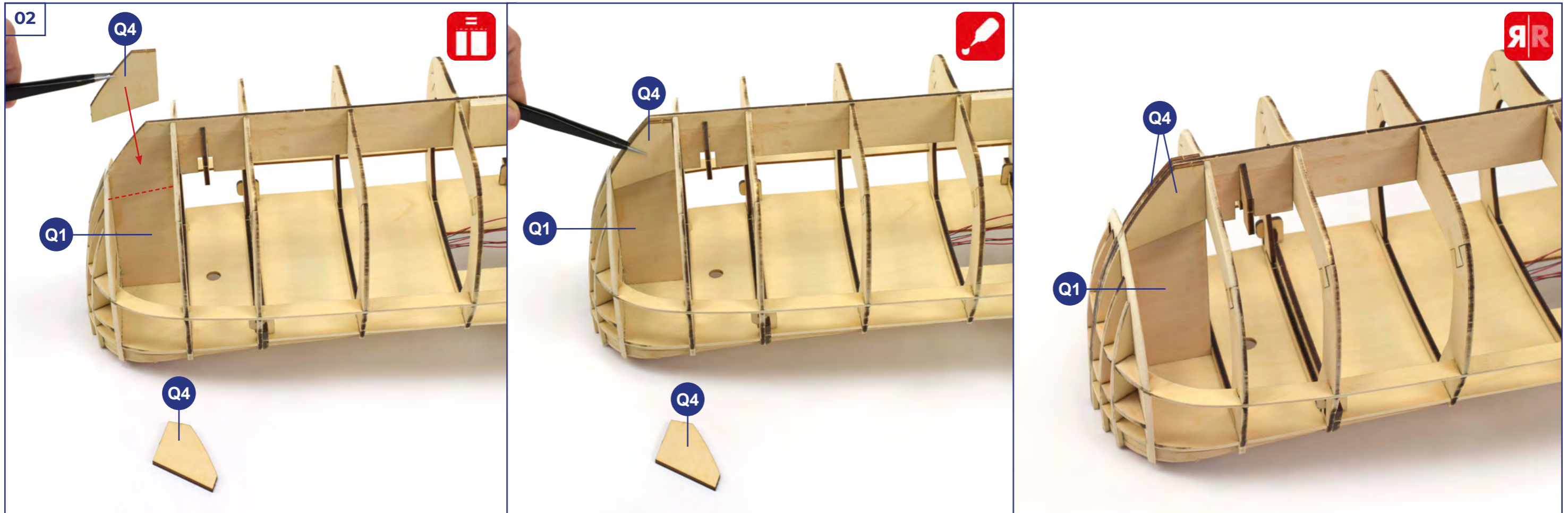

03

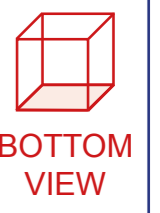
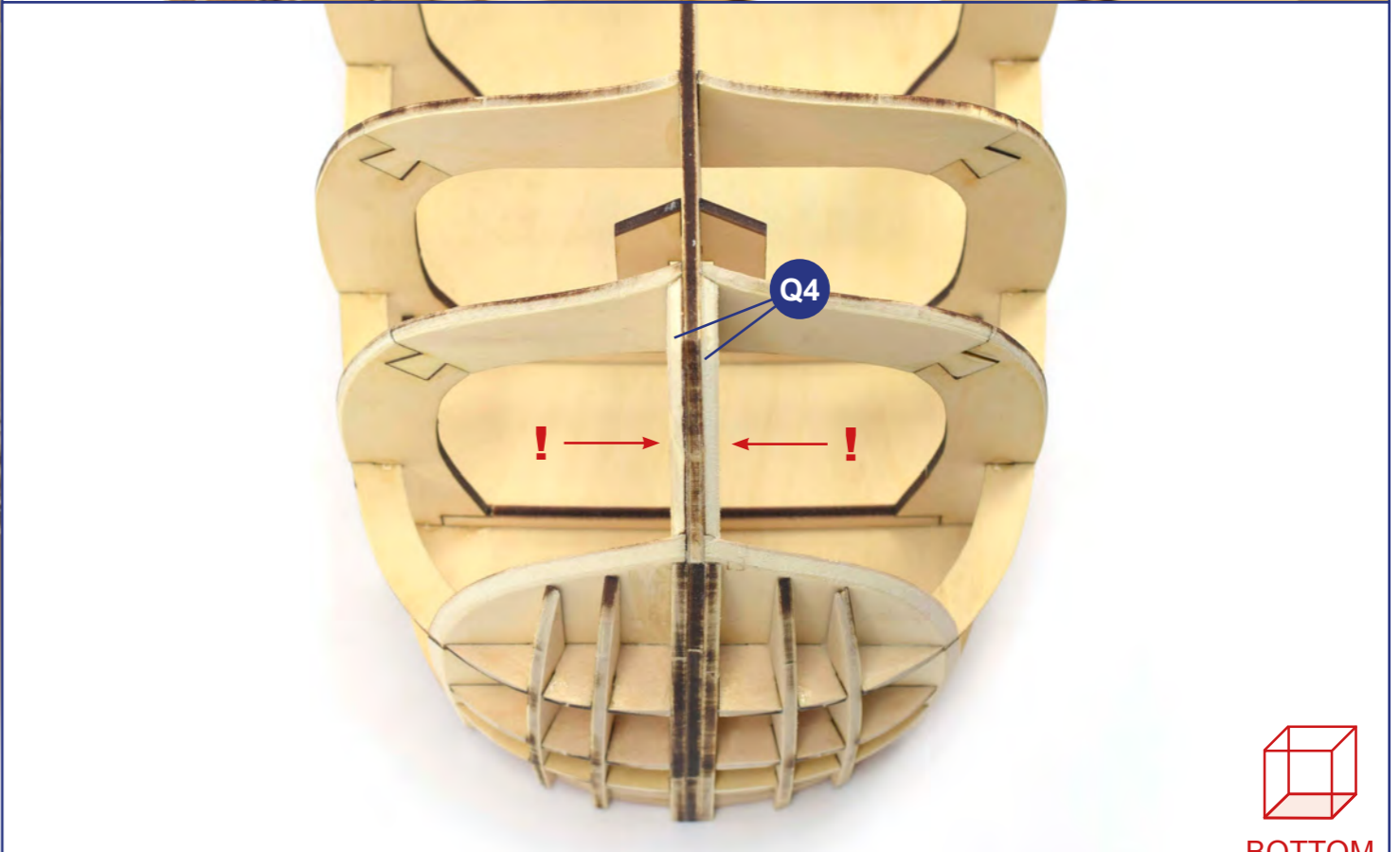
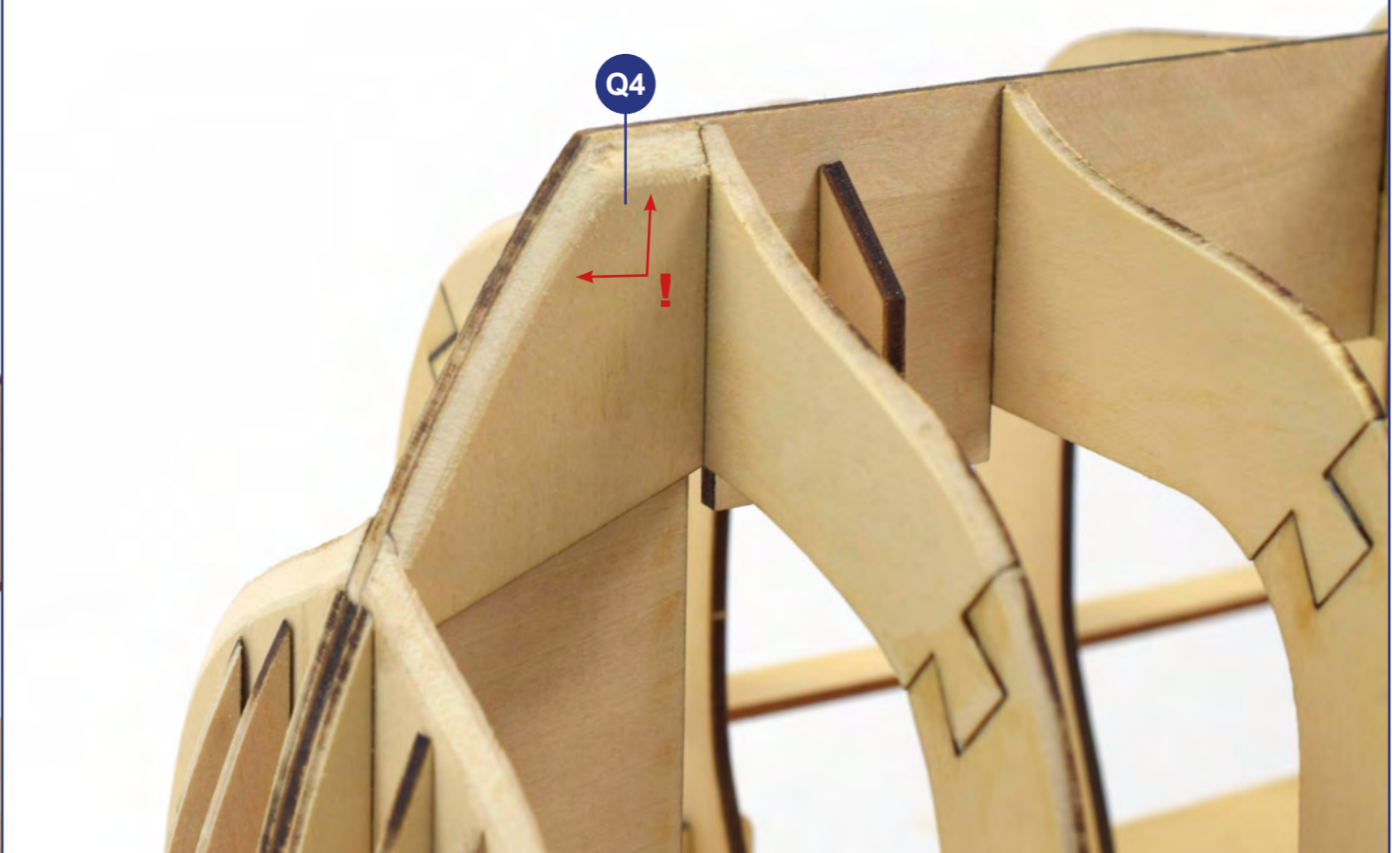
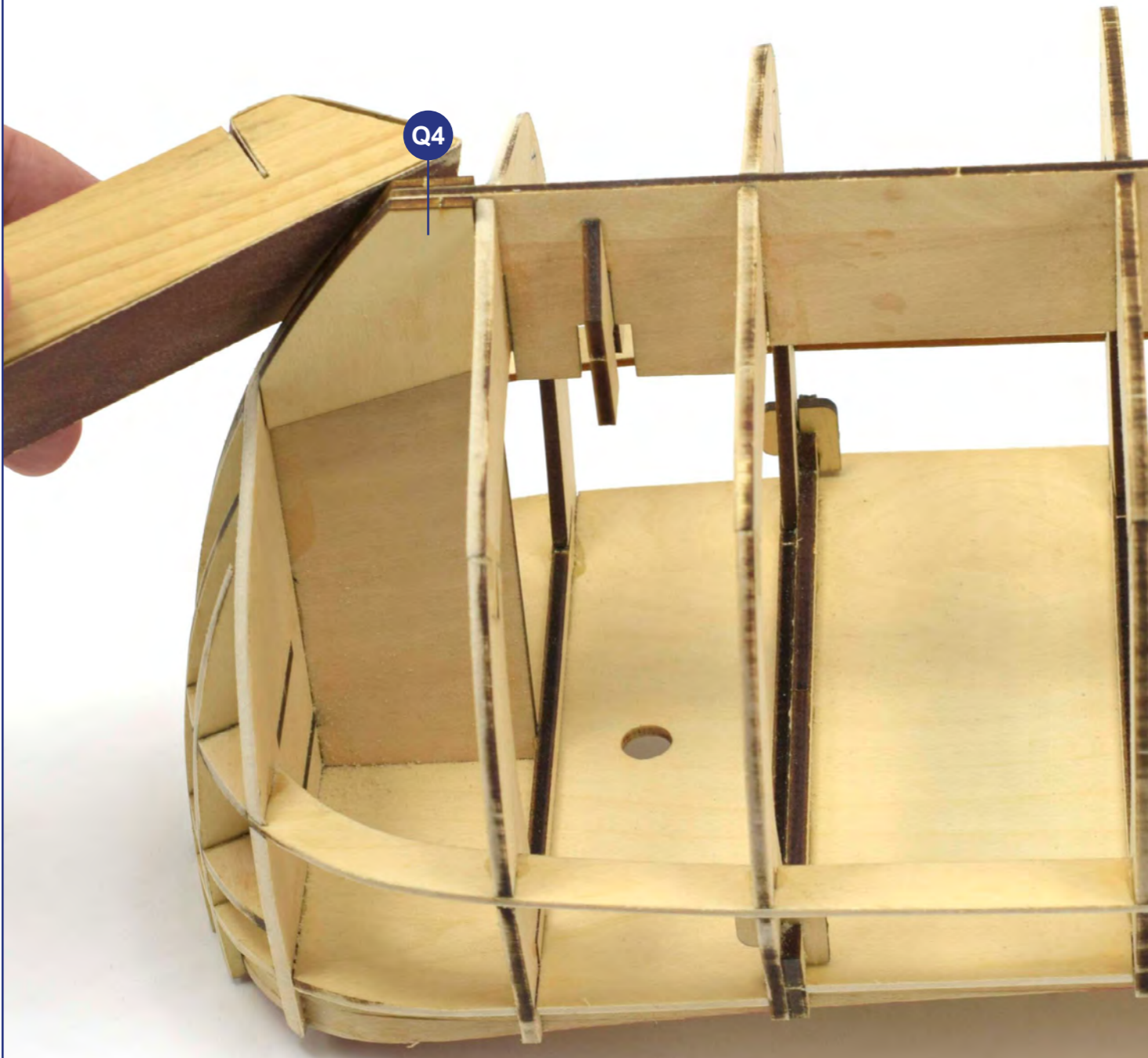

04

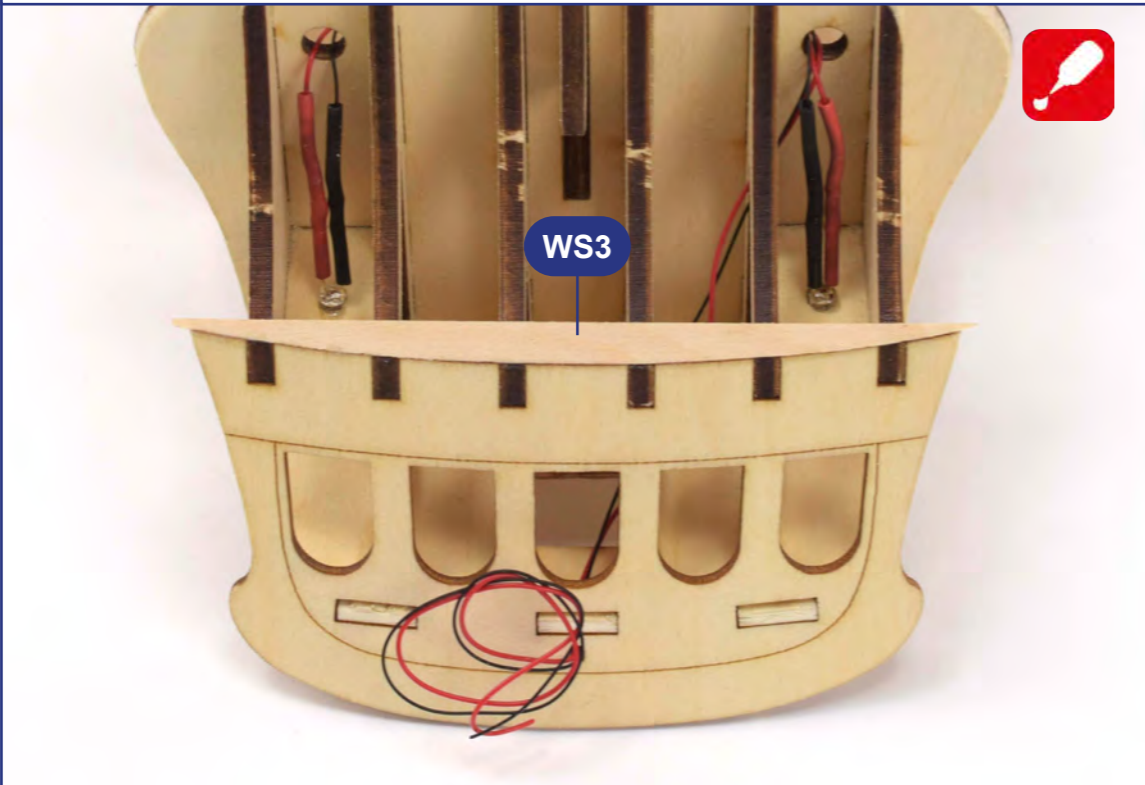
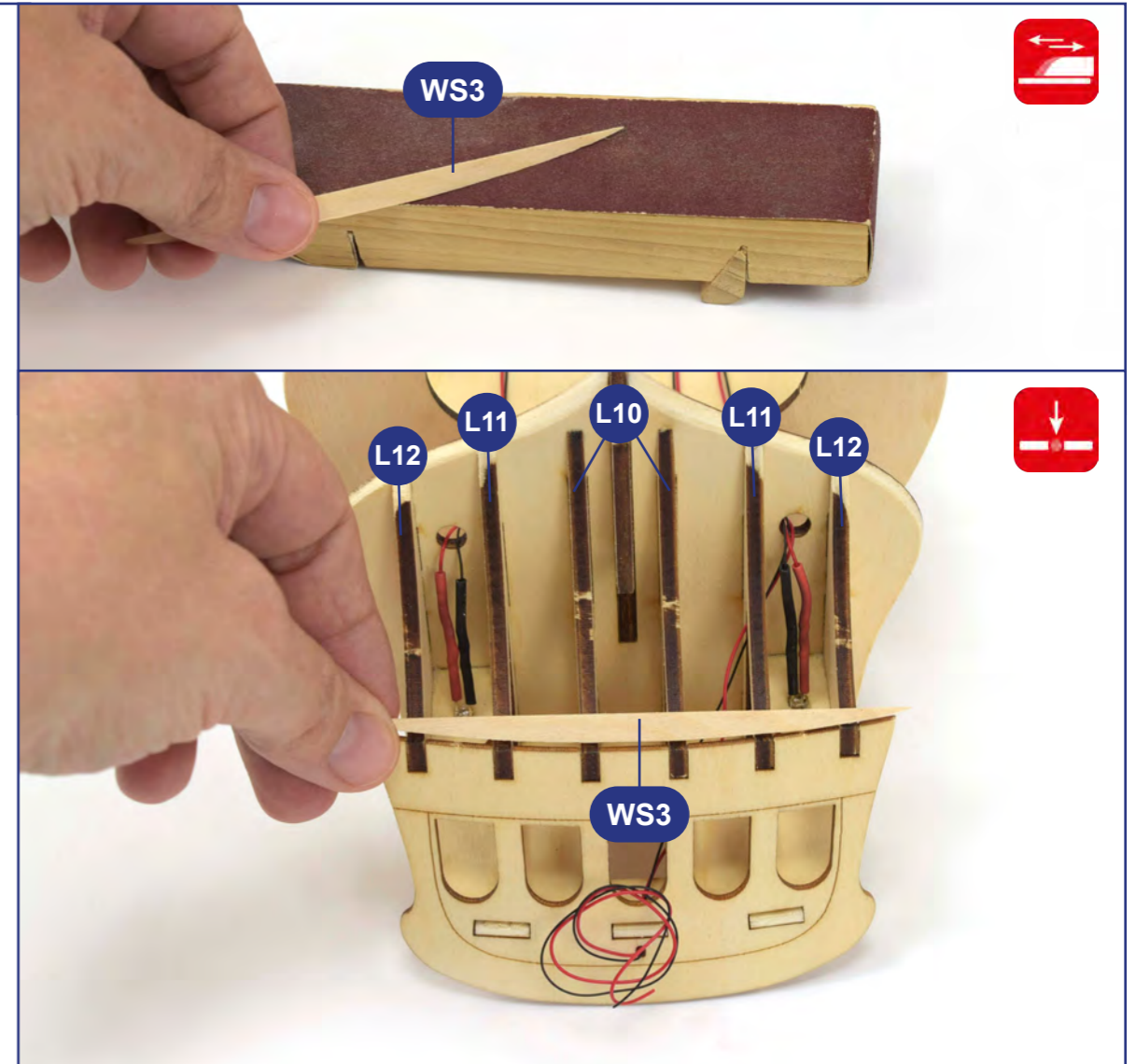
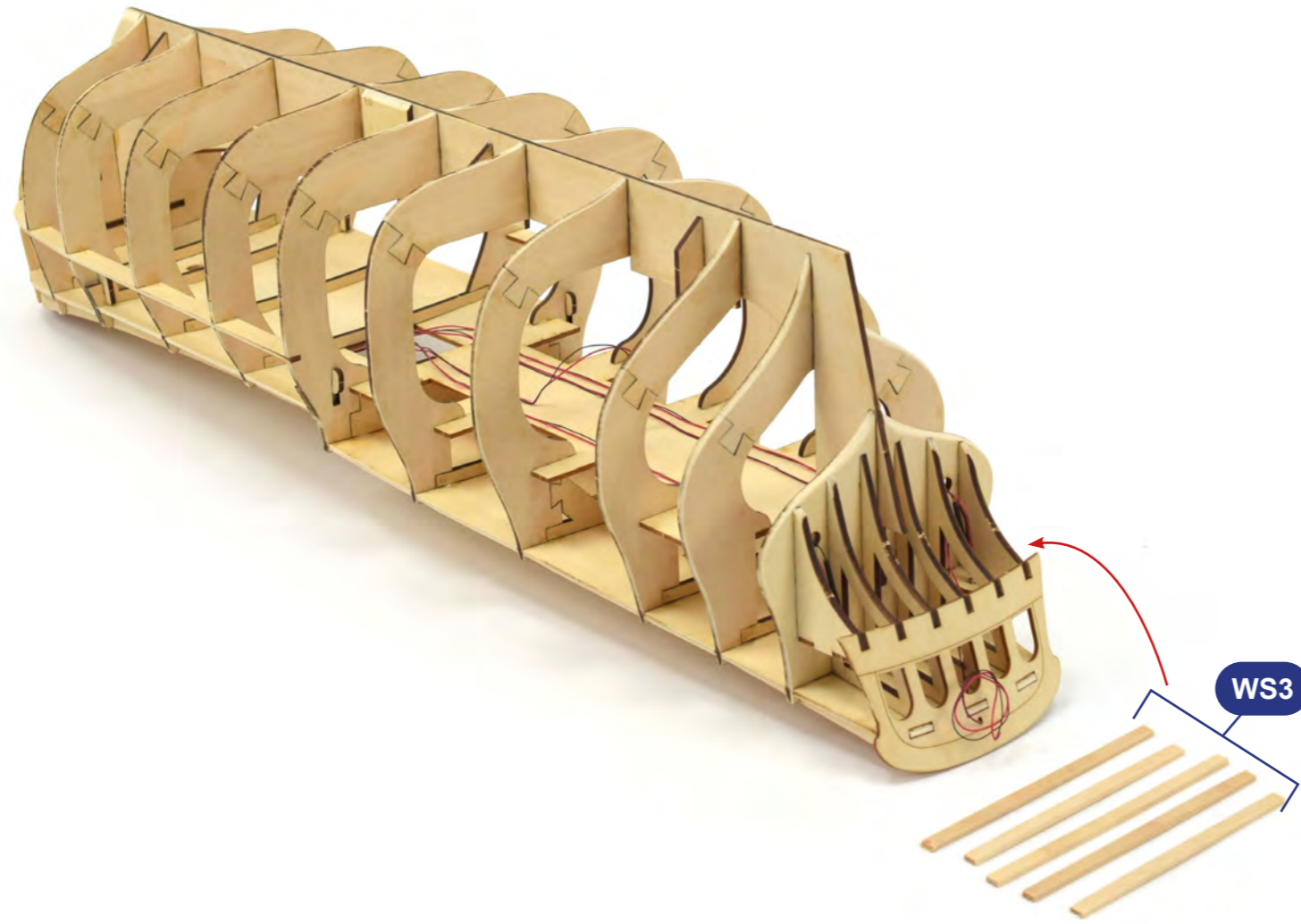

05



06

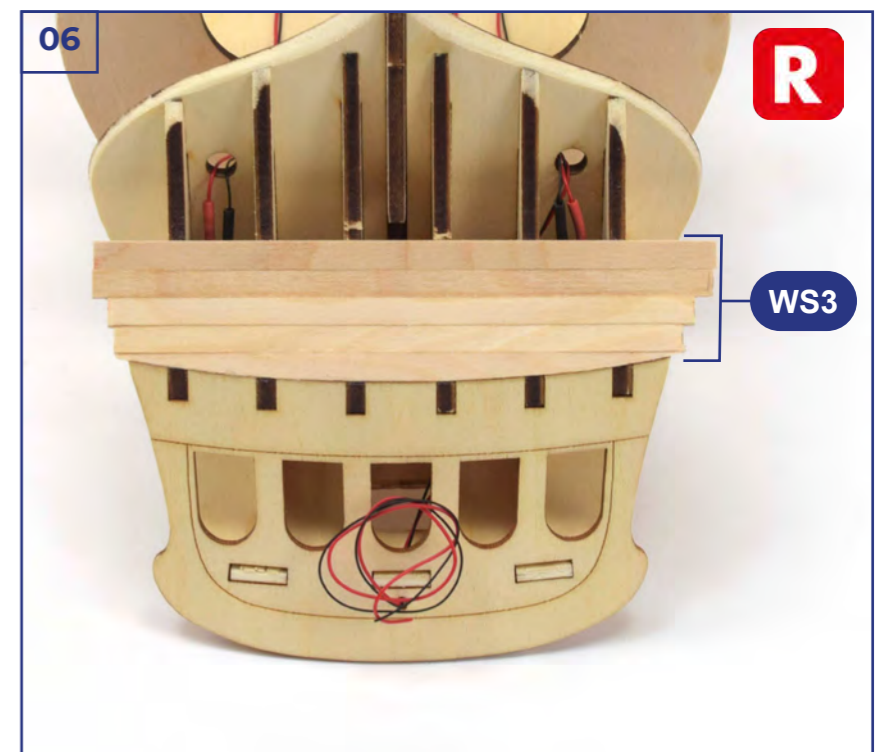

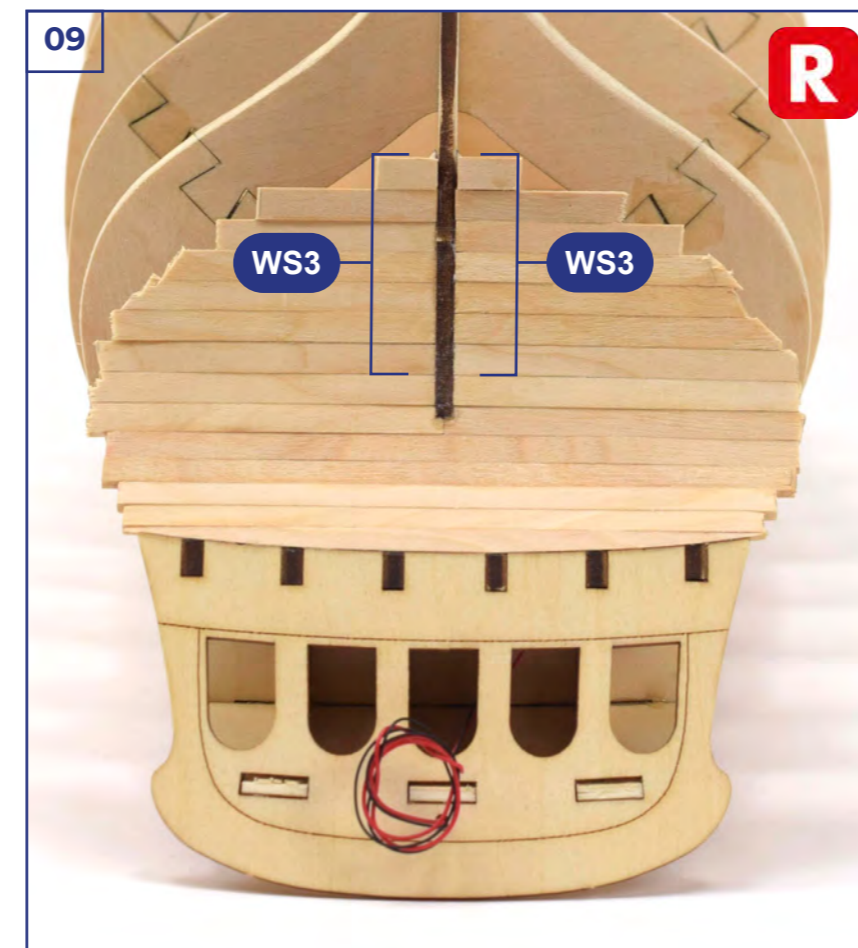
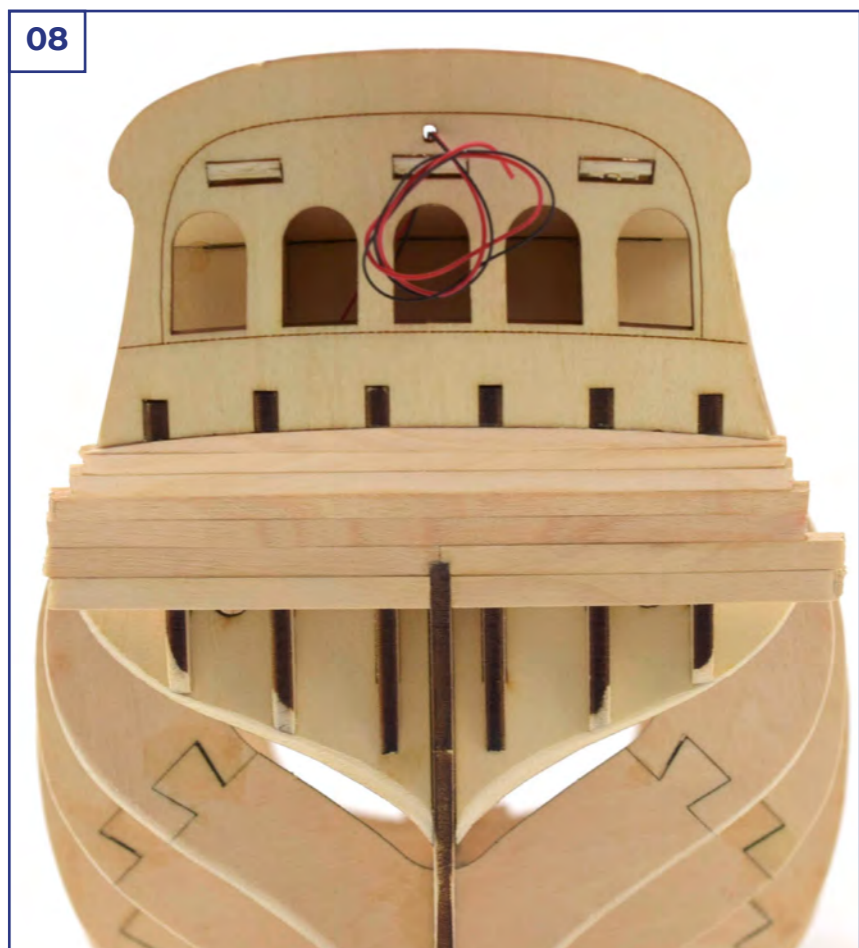
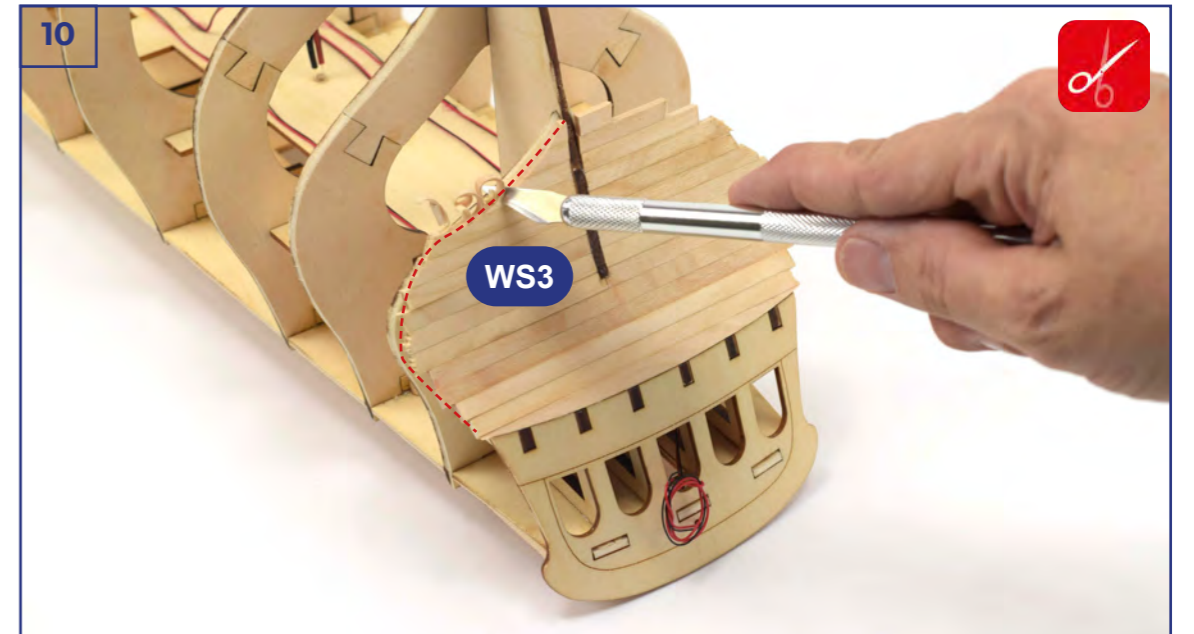

11

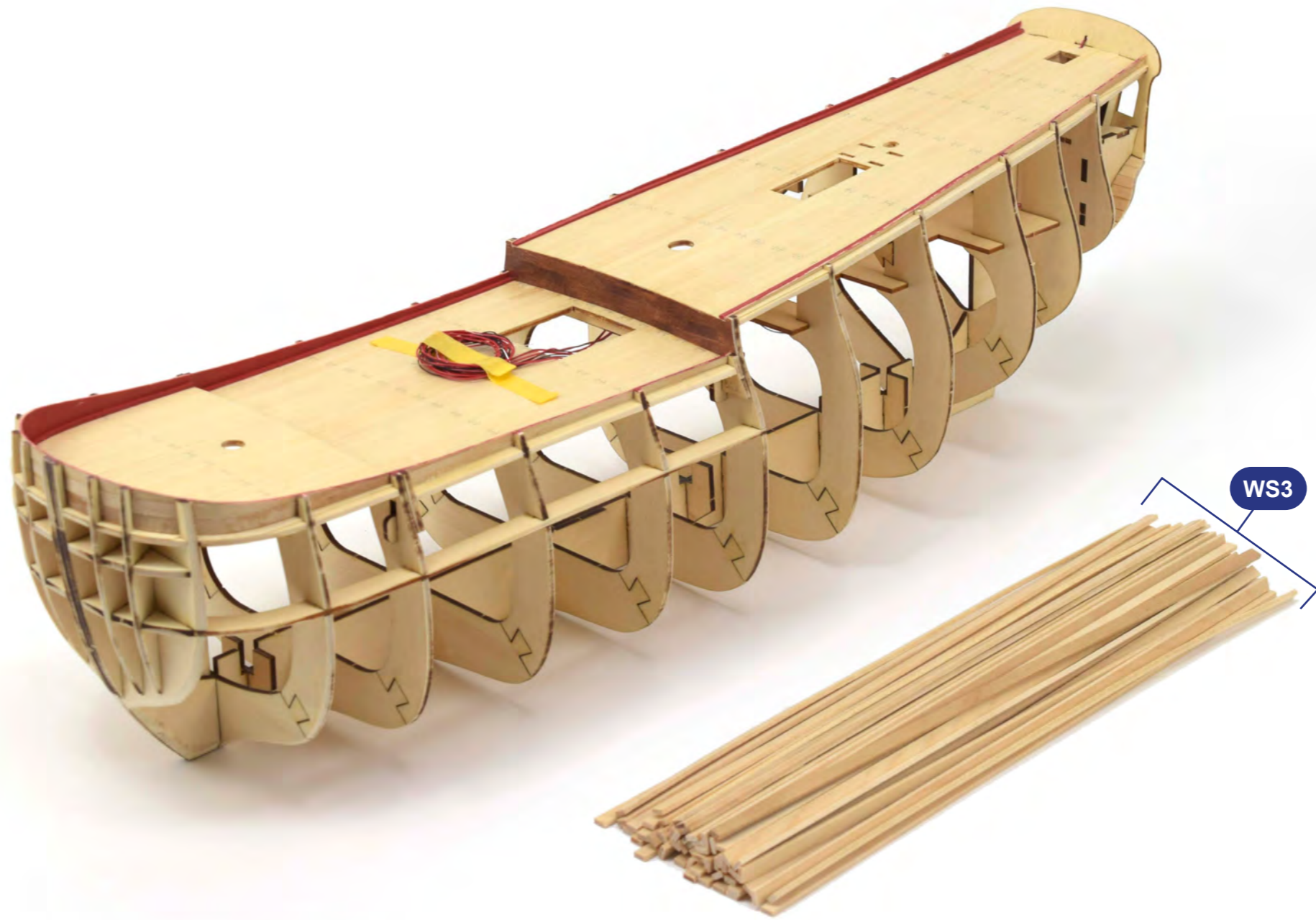

12



13

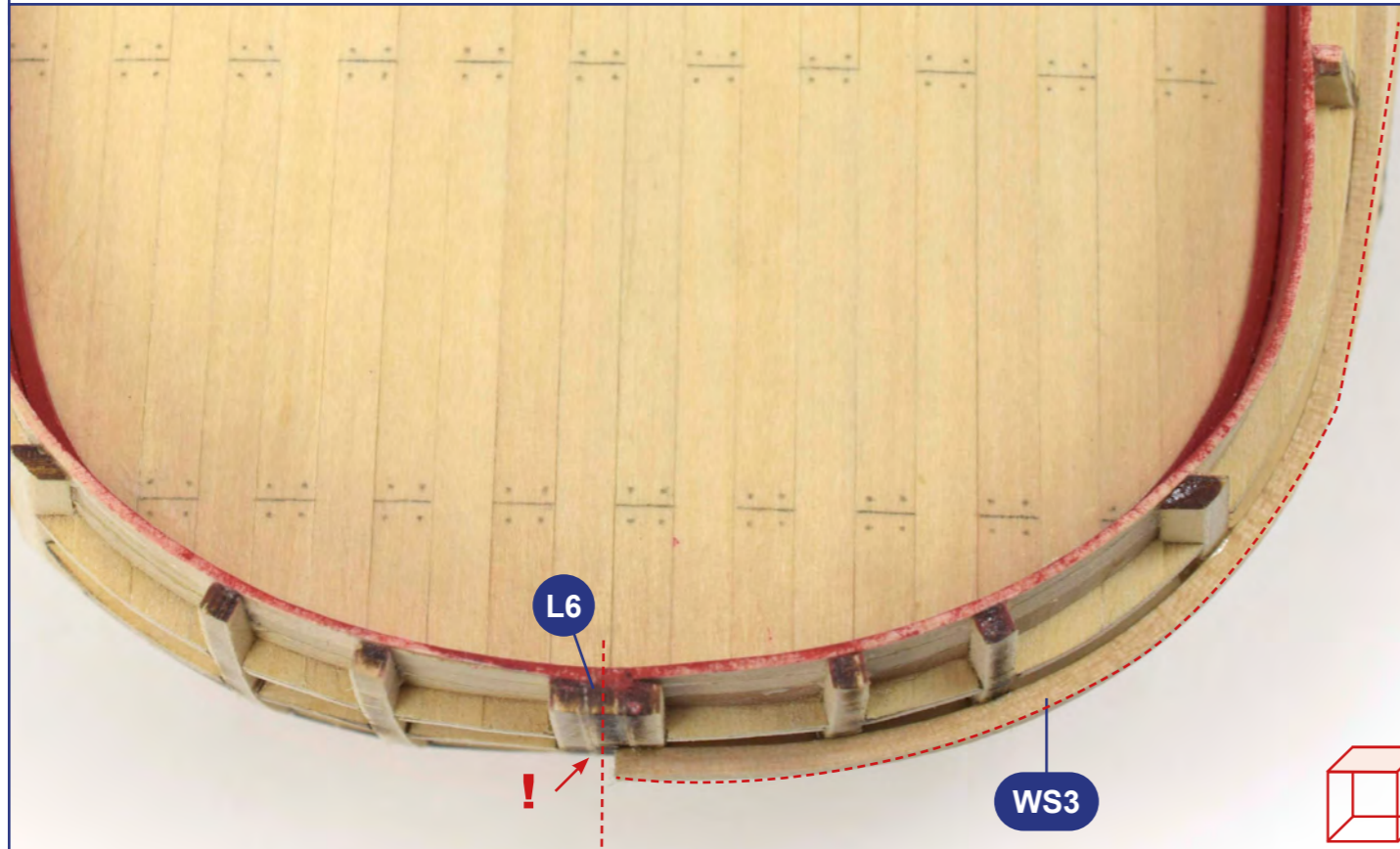
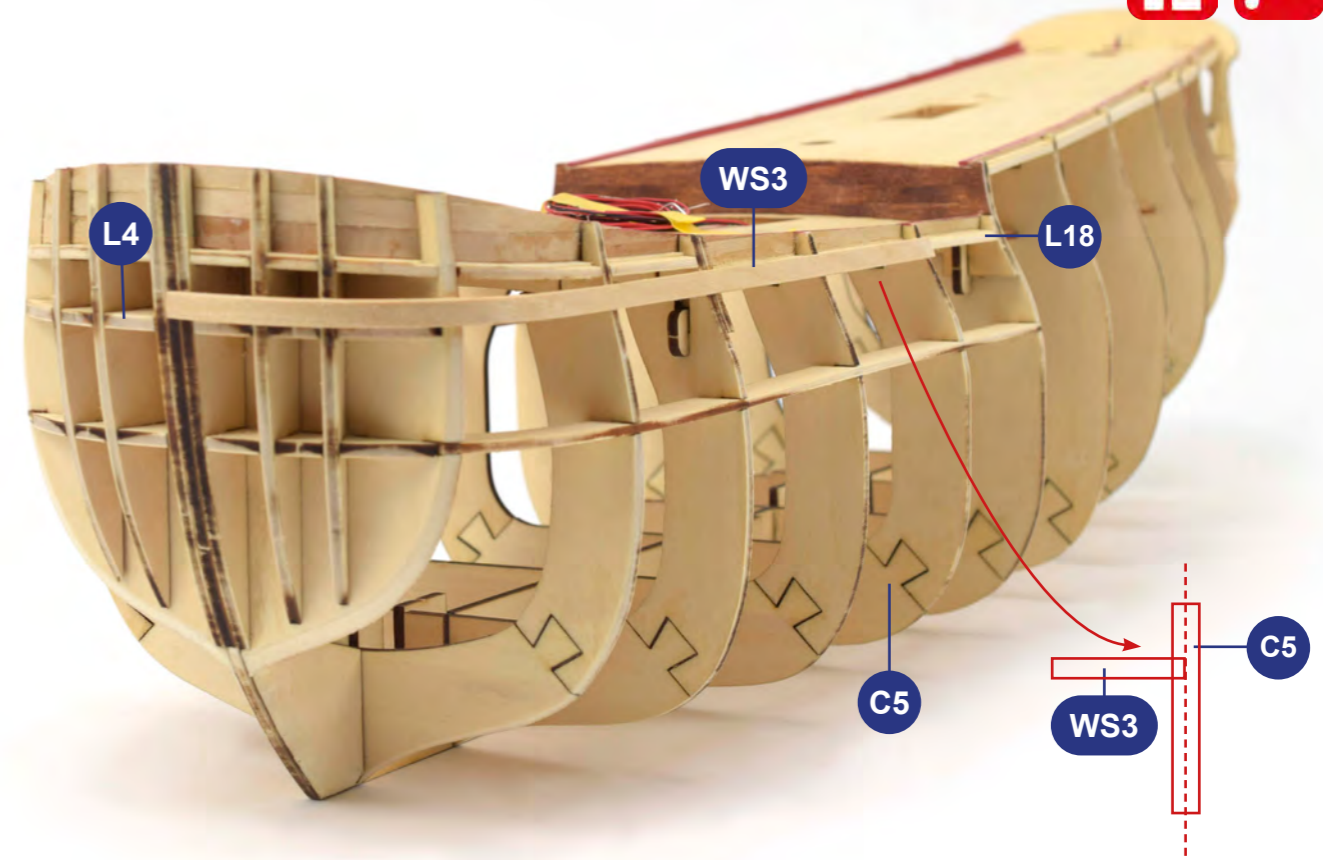
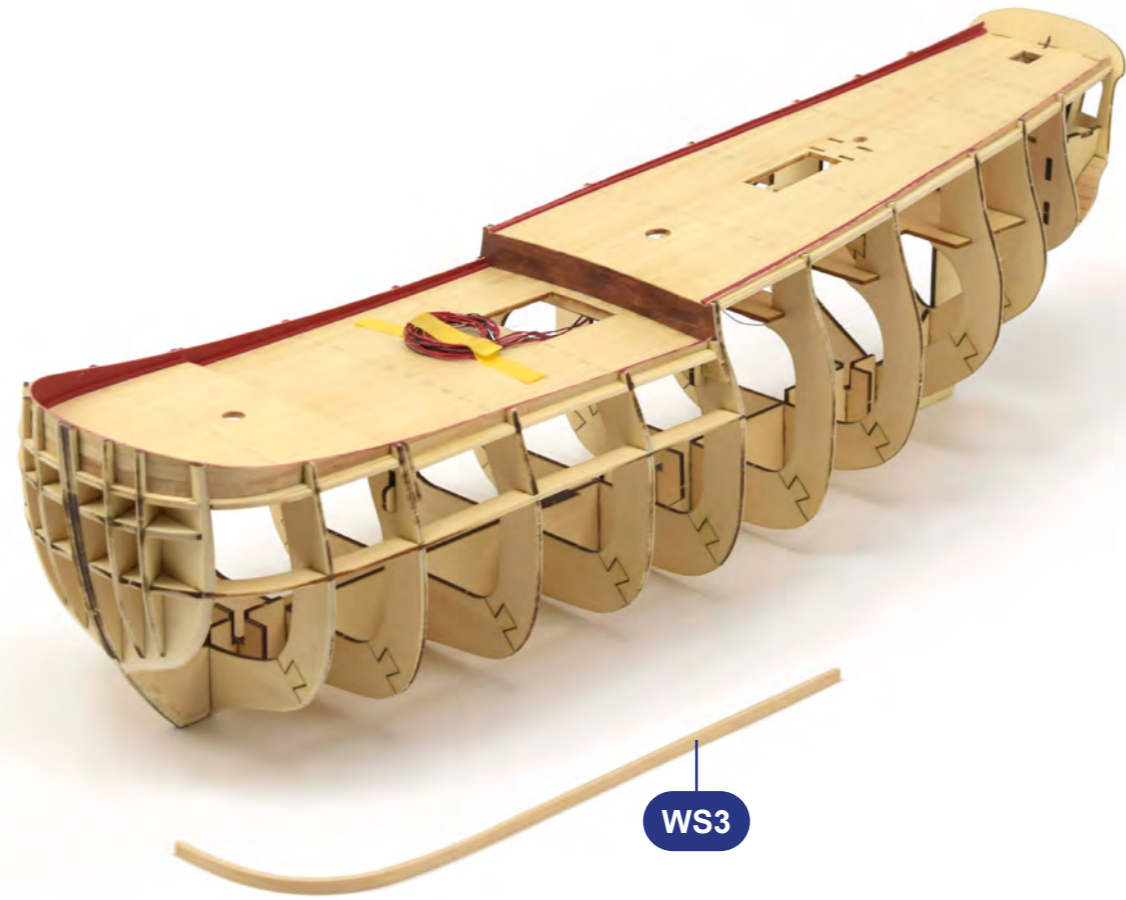

TOP VIEW

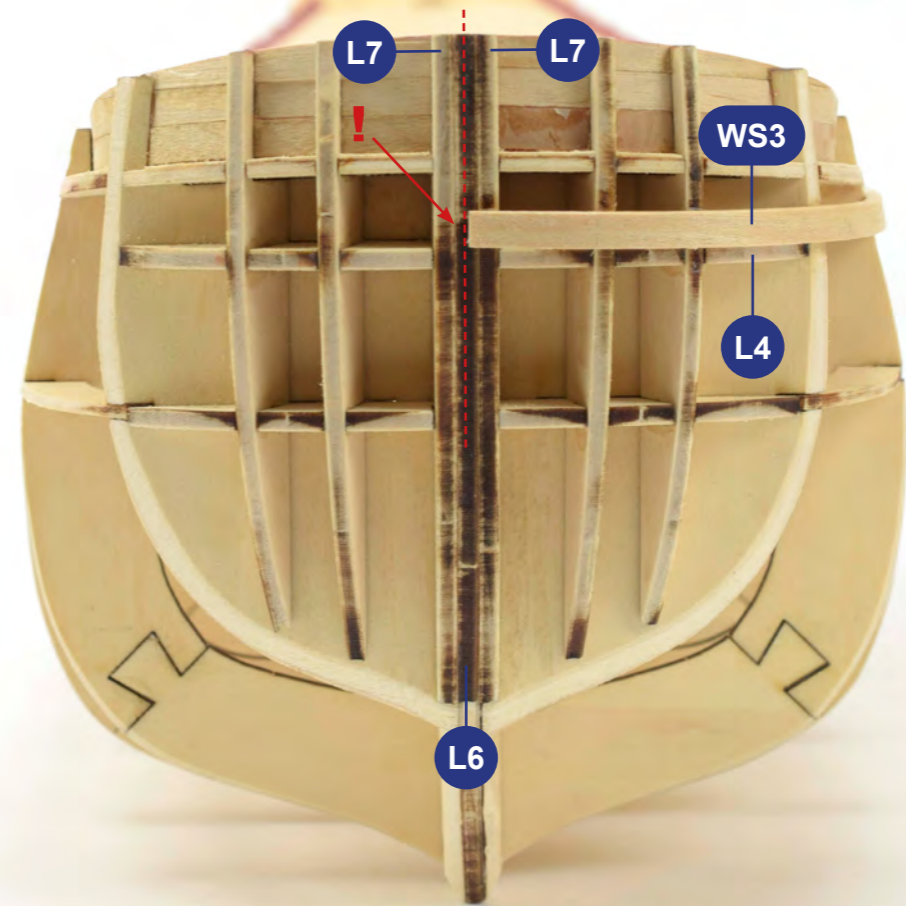

FRONT VIEW

14

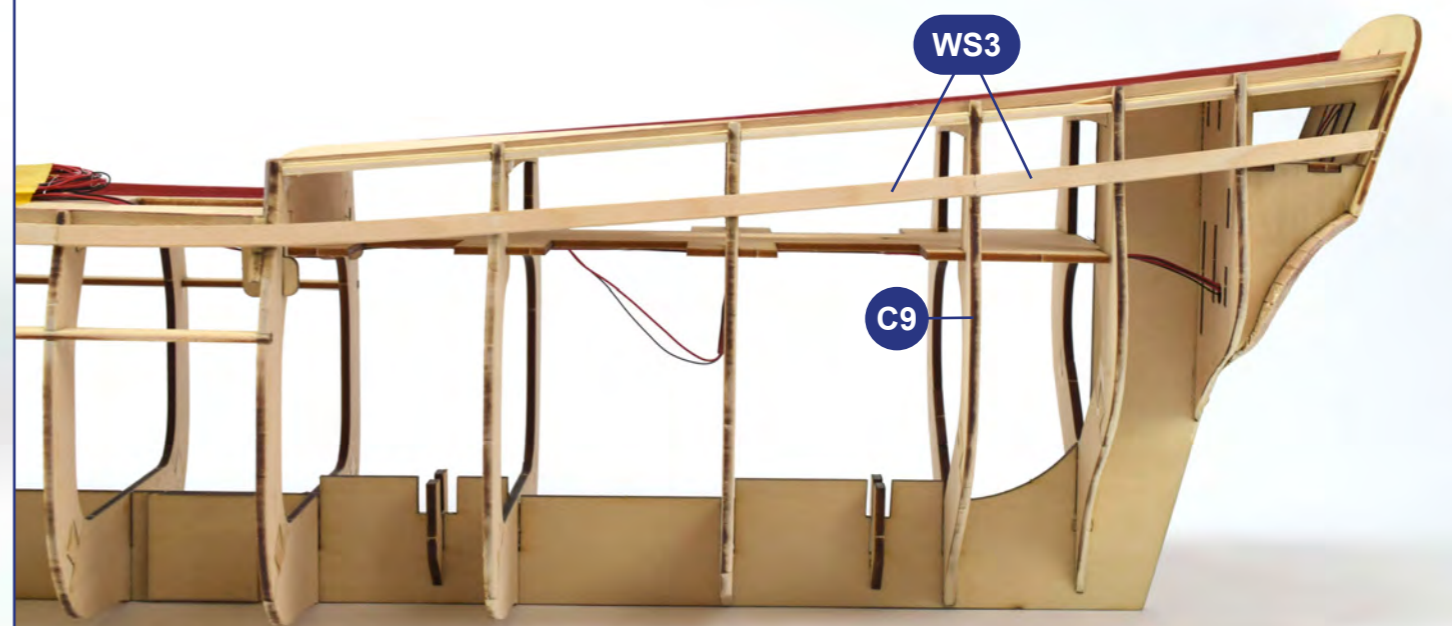
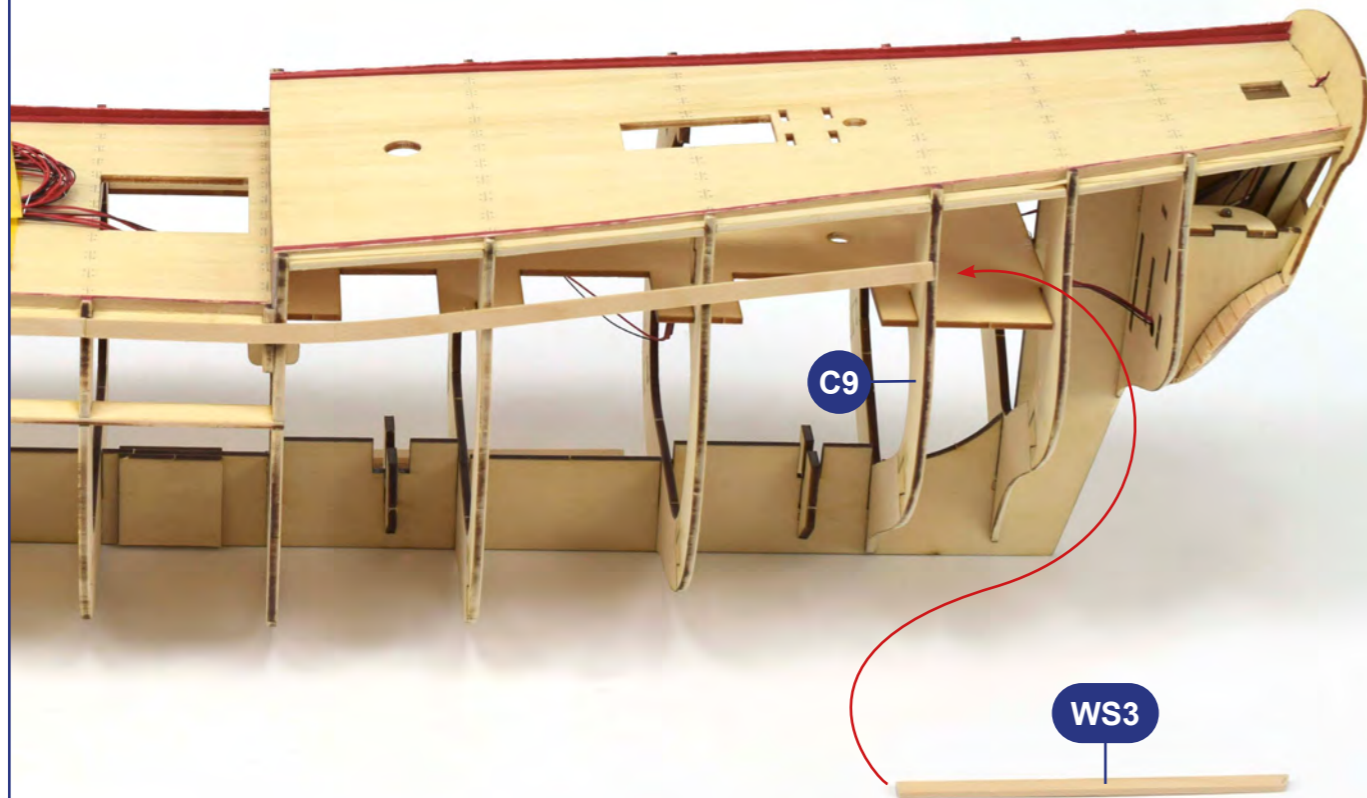
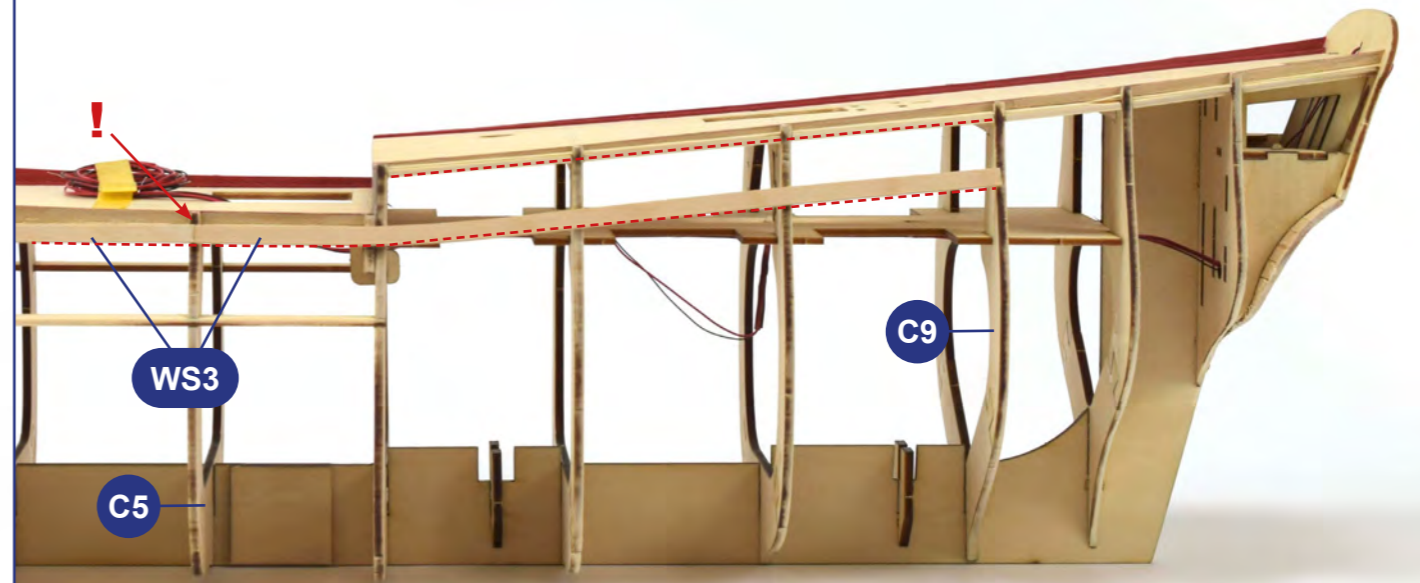
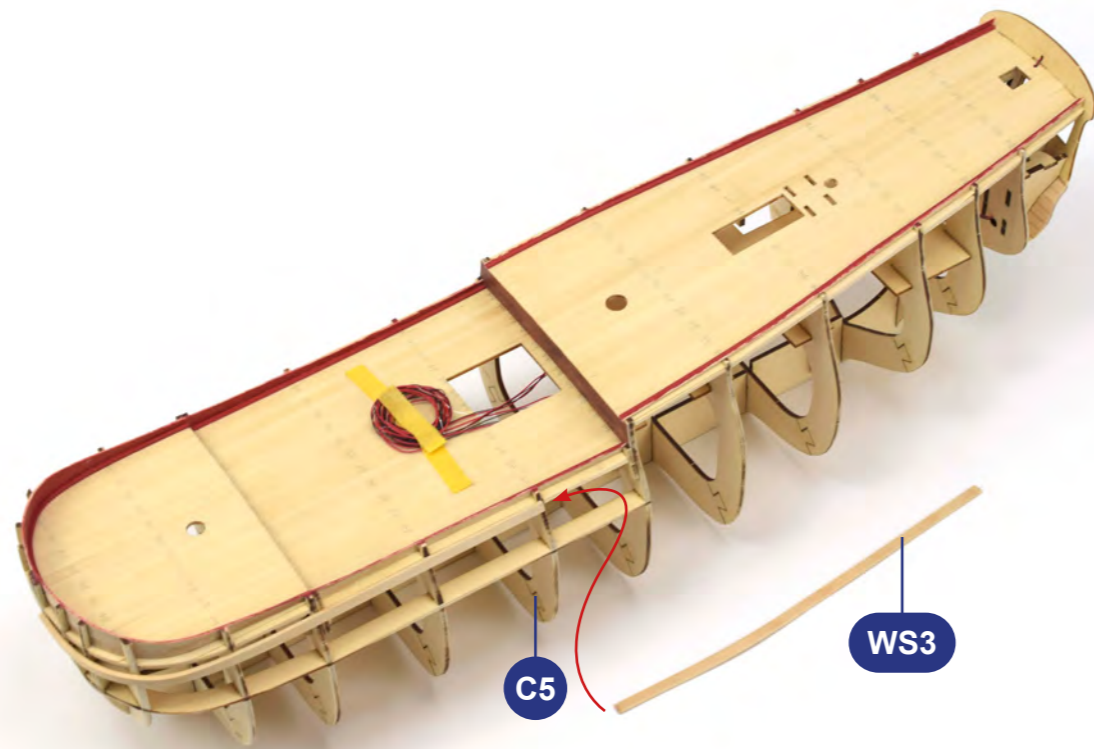

15

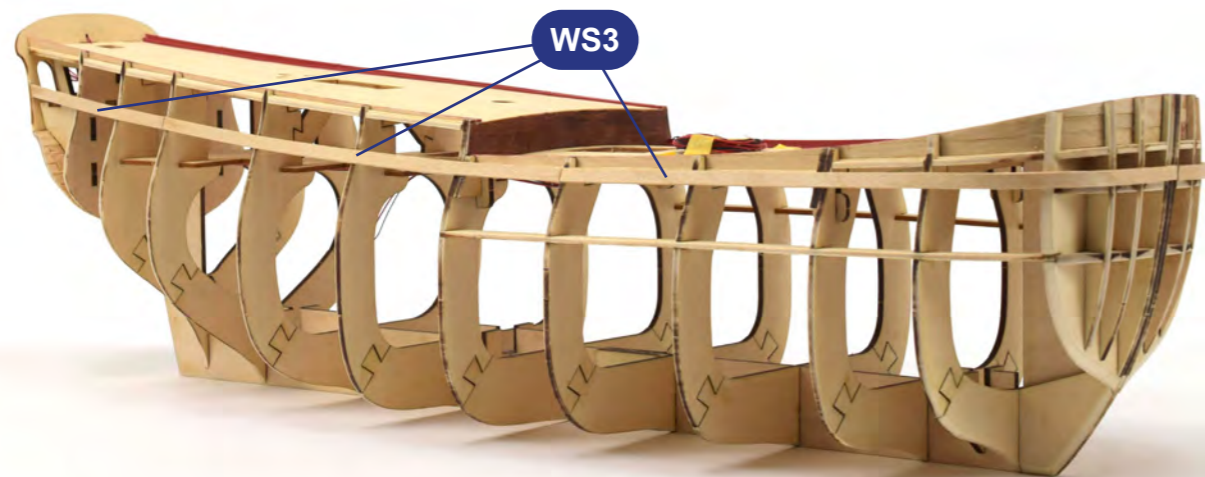
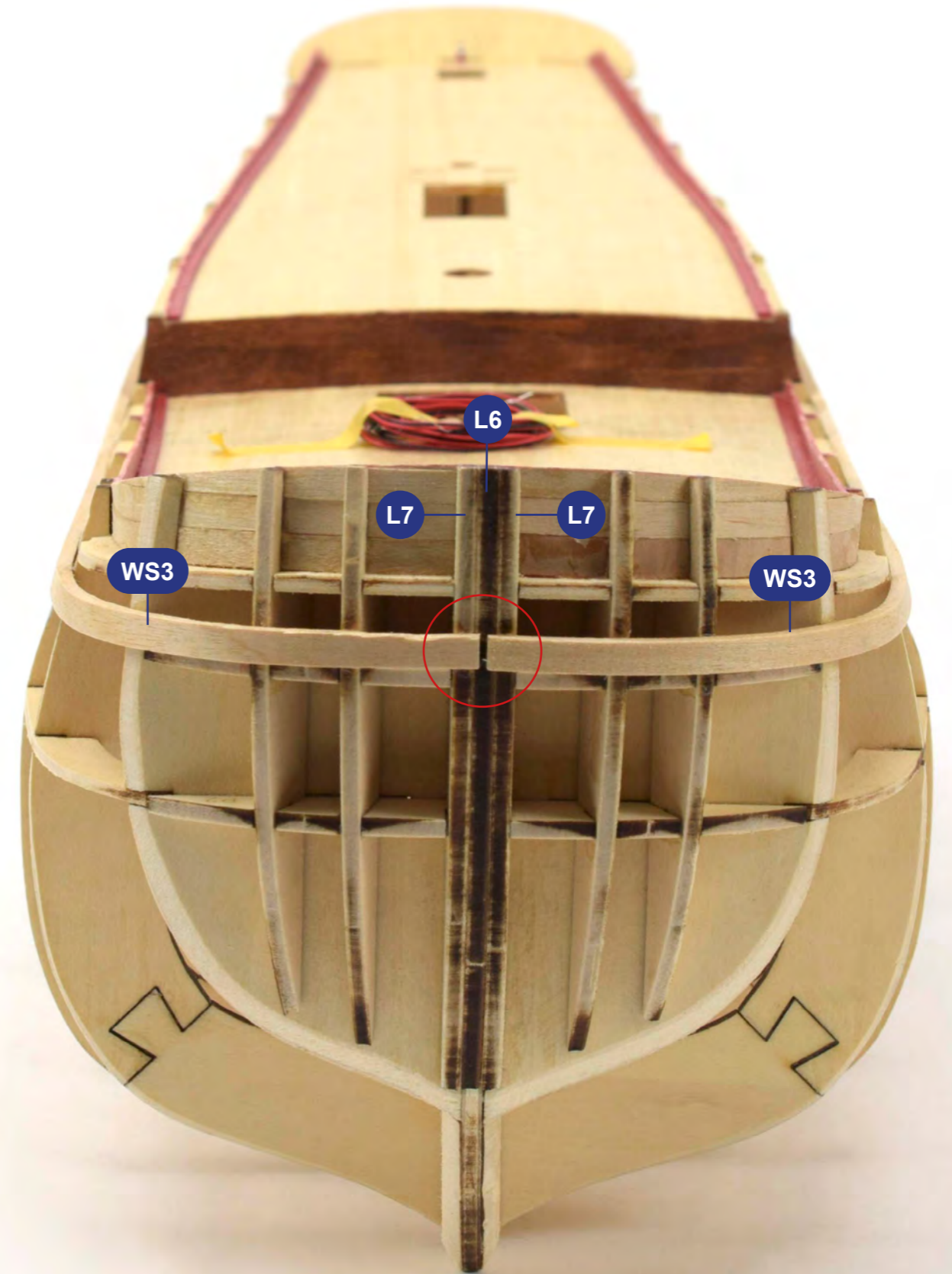
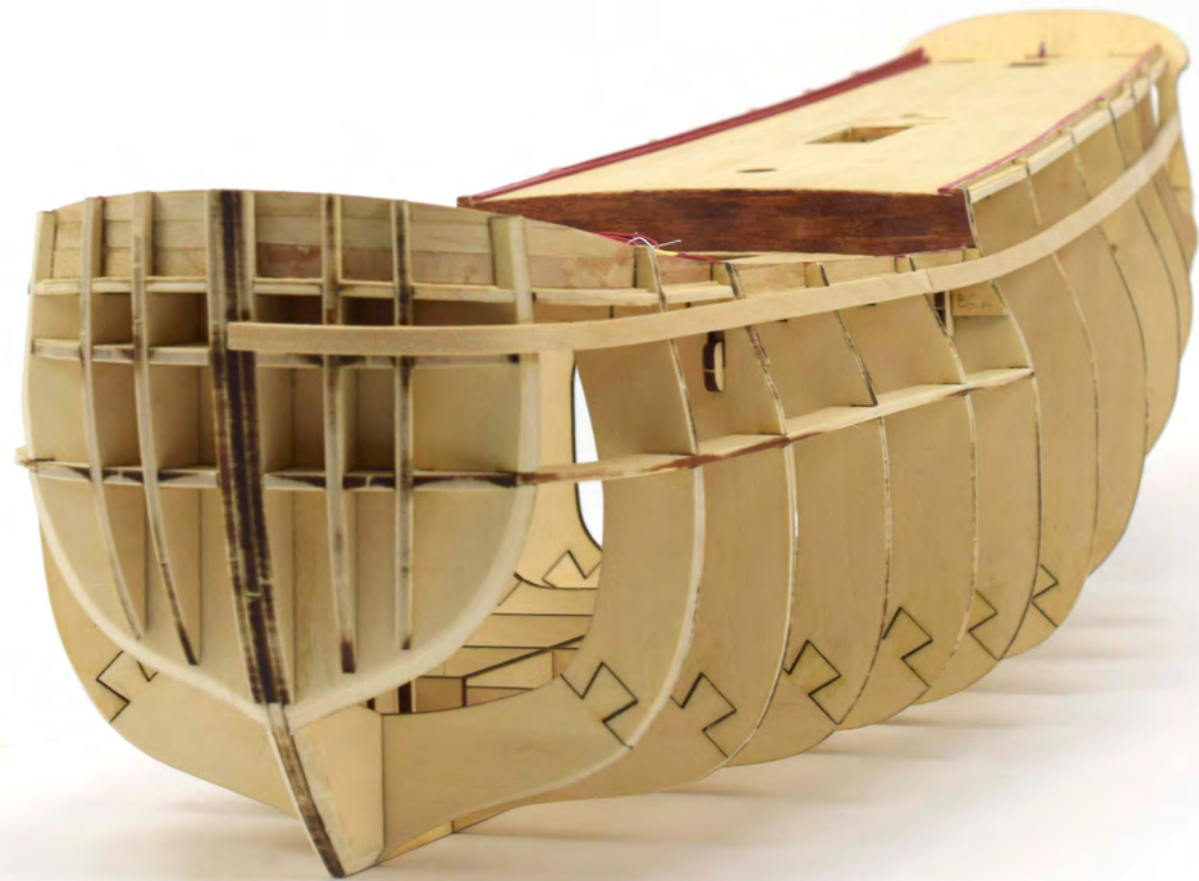

16

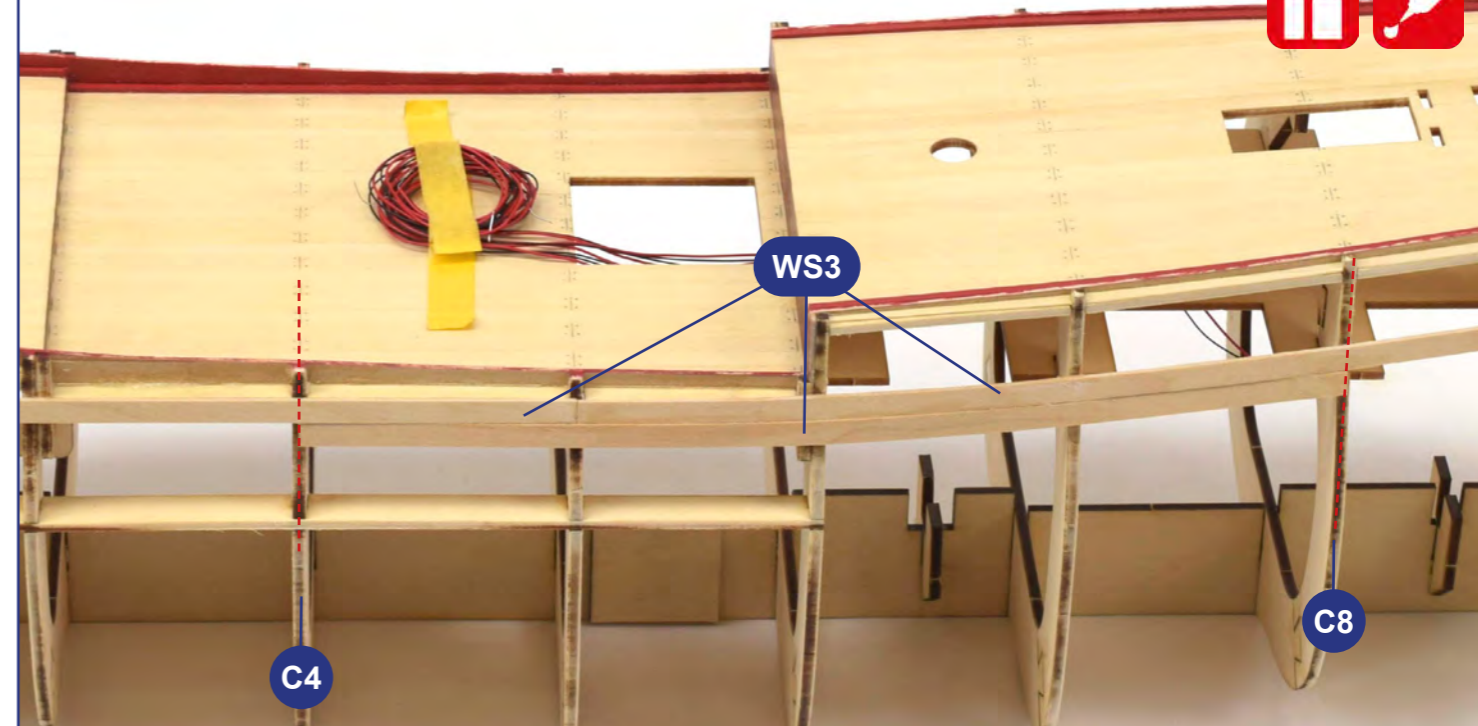
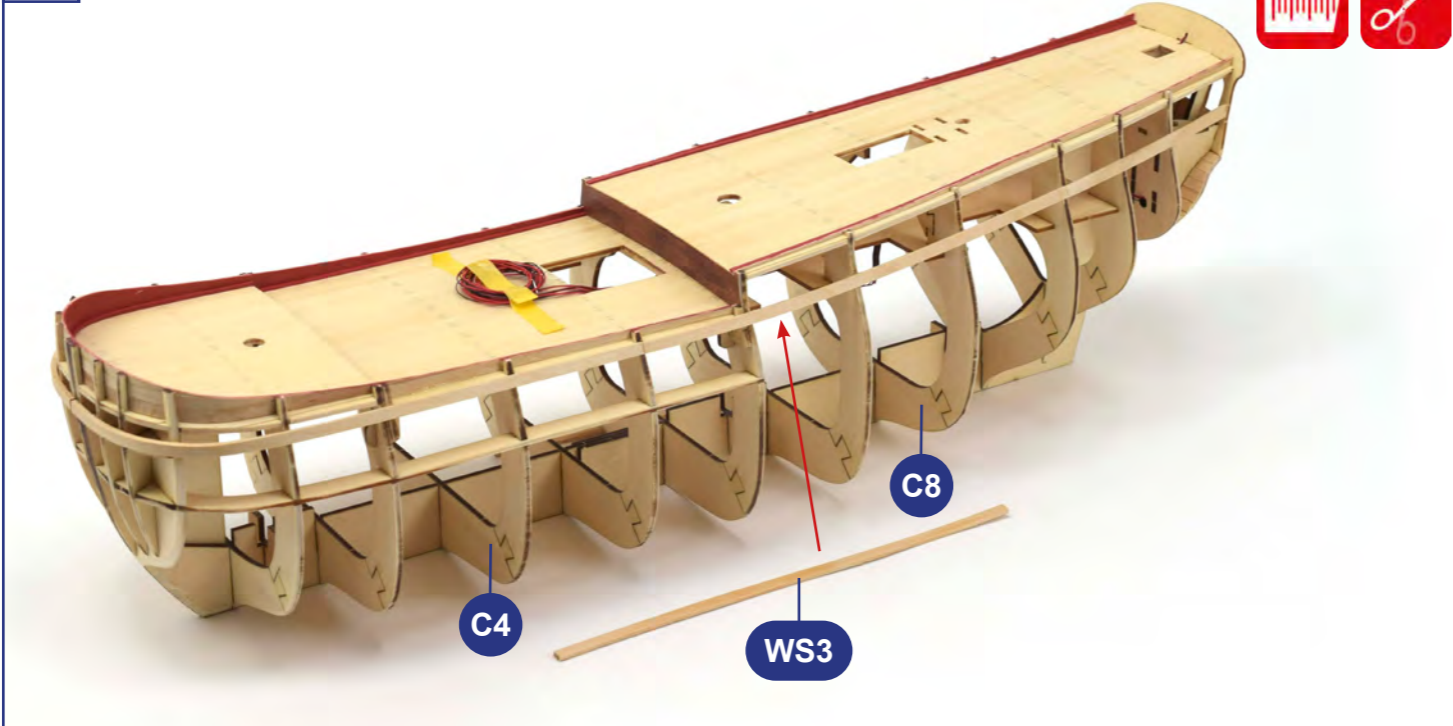

LEFT VIEW

17

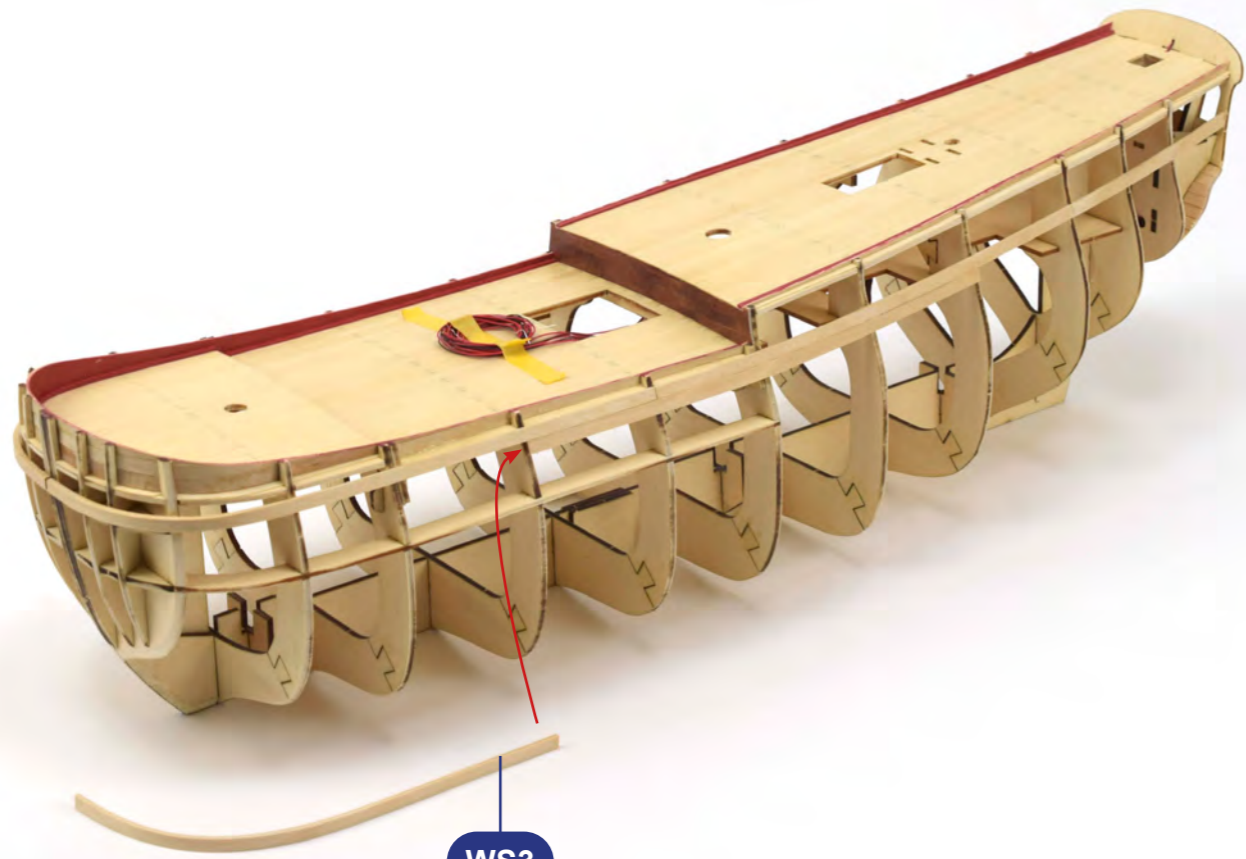

WS3

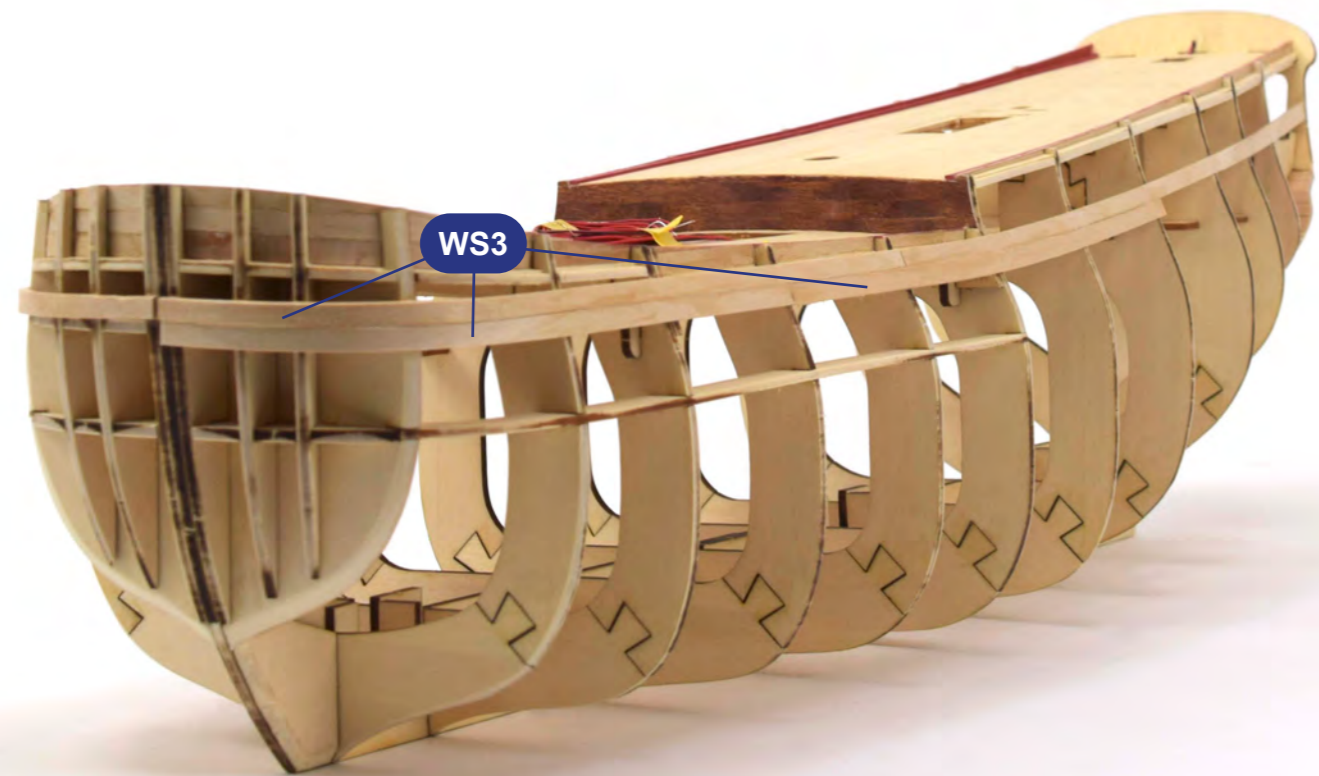

WS3

WS3



FRONT VIEW

18

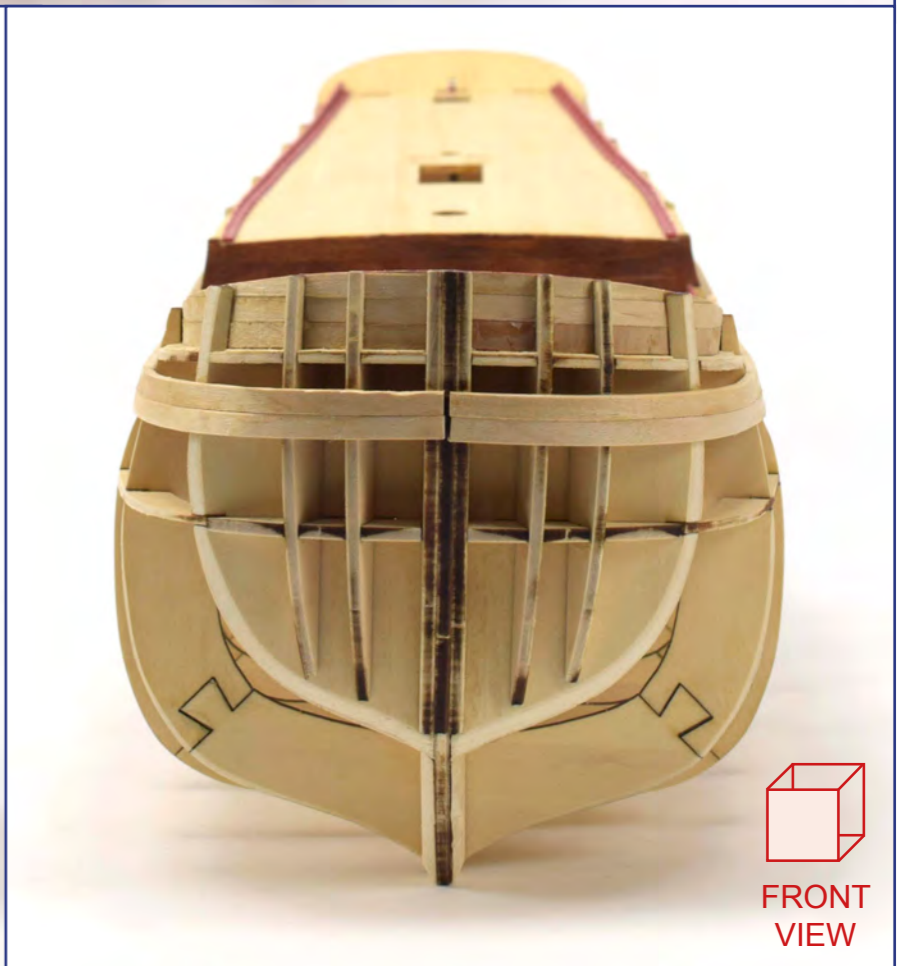
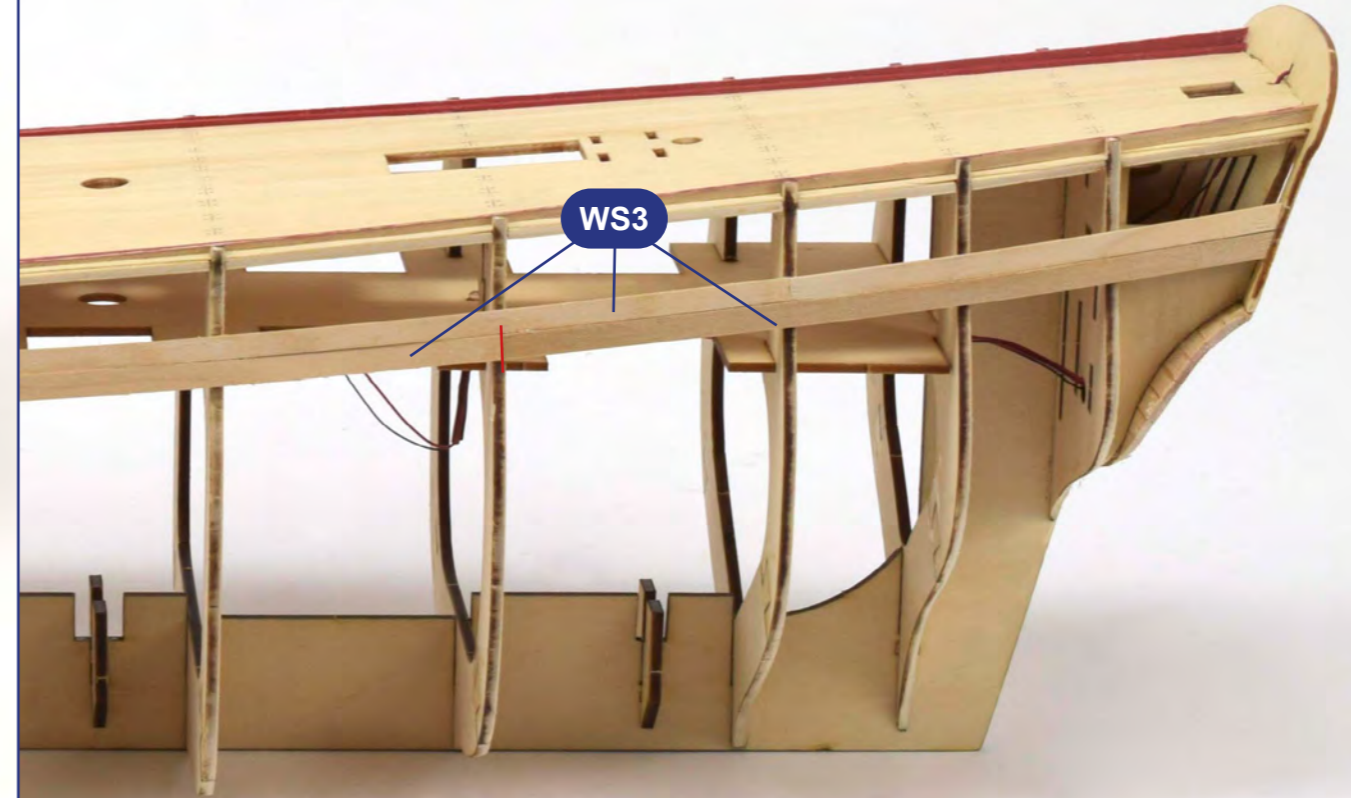
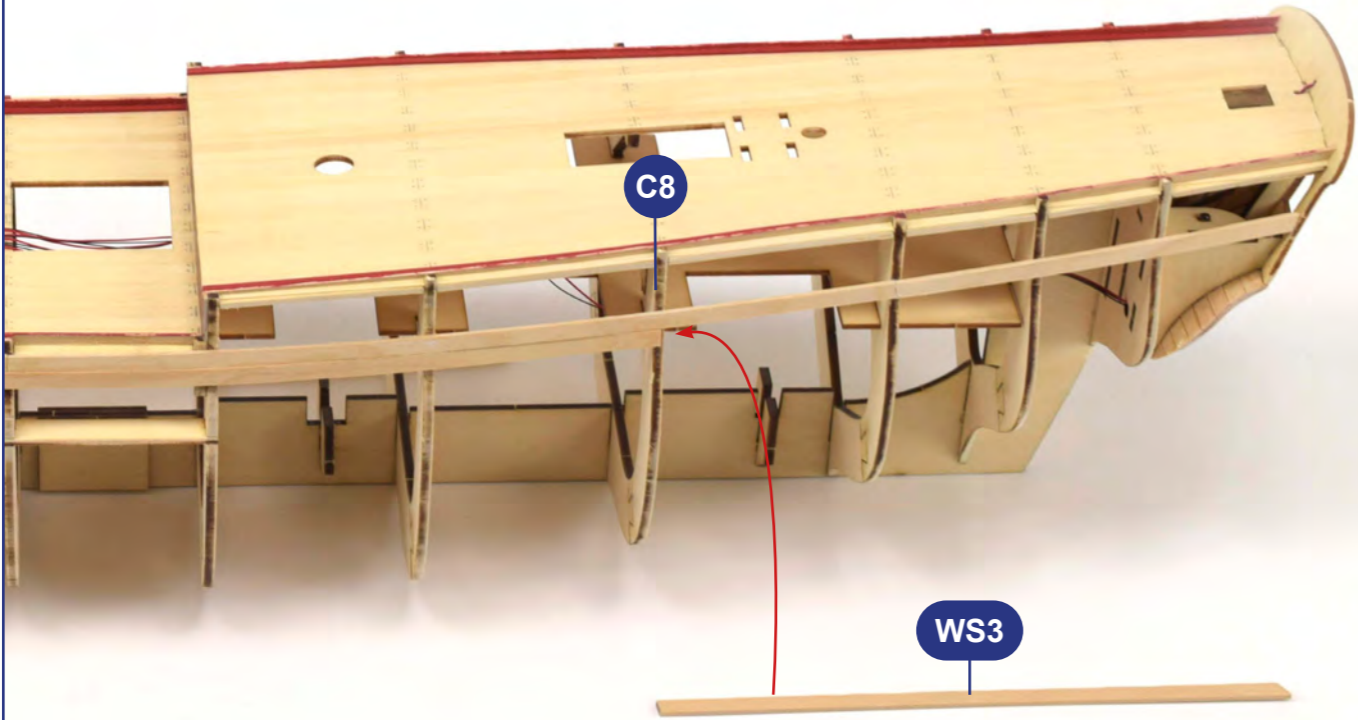

19

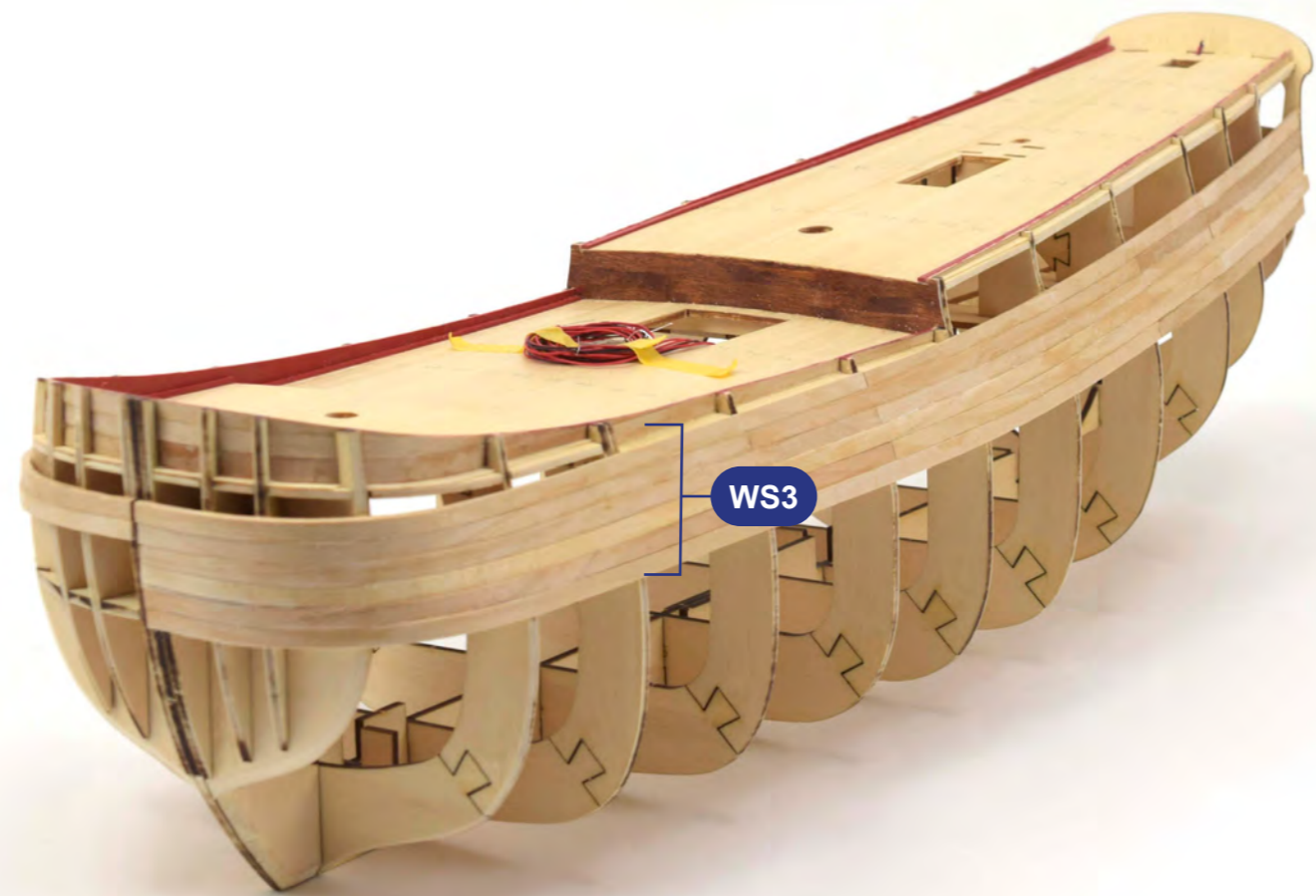

R

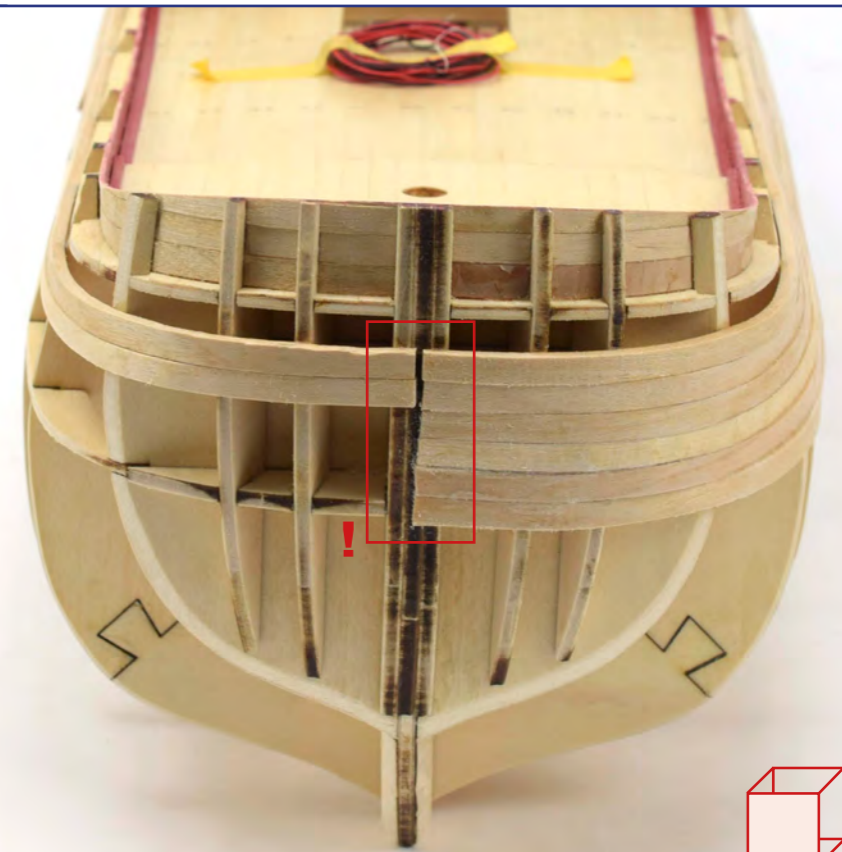

FRONT VIEW

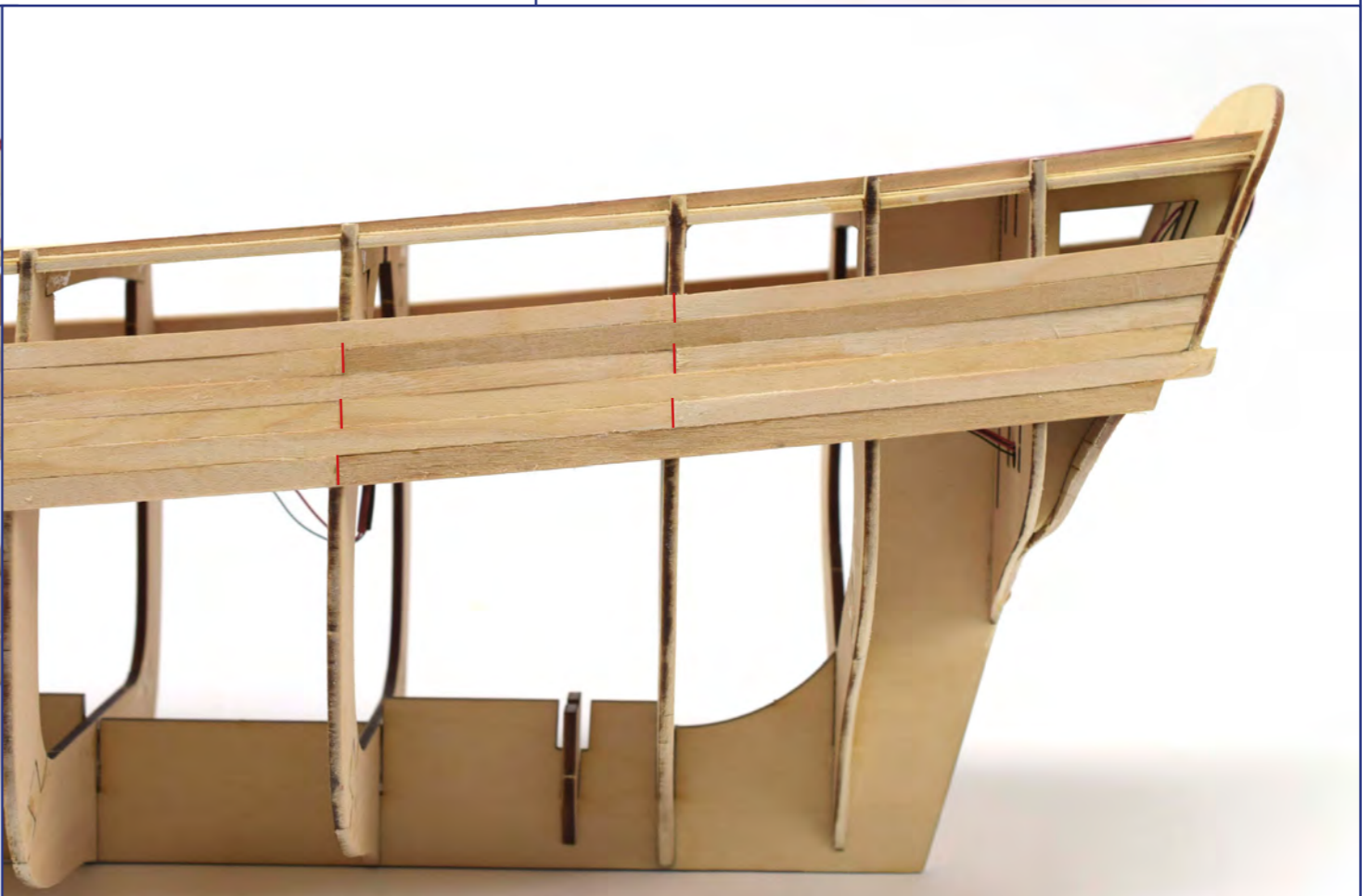

20



21

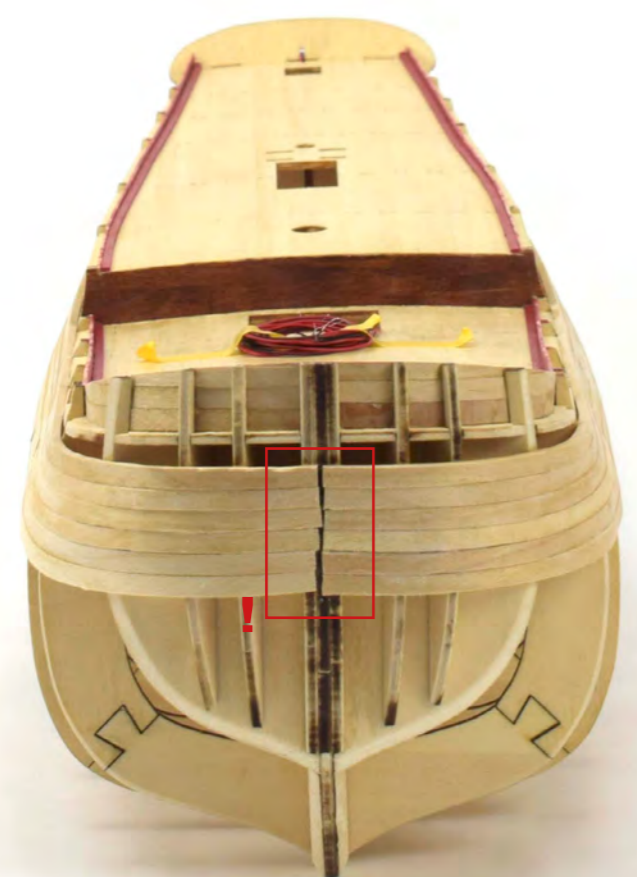
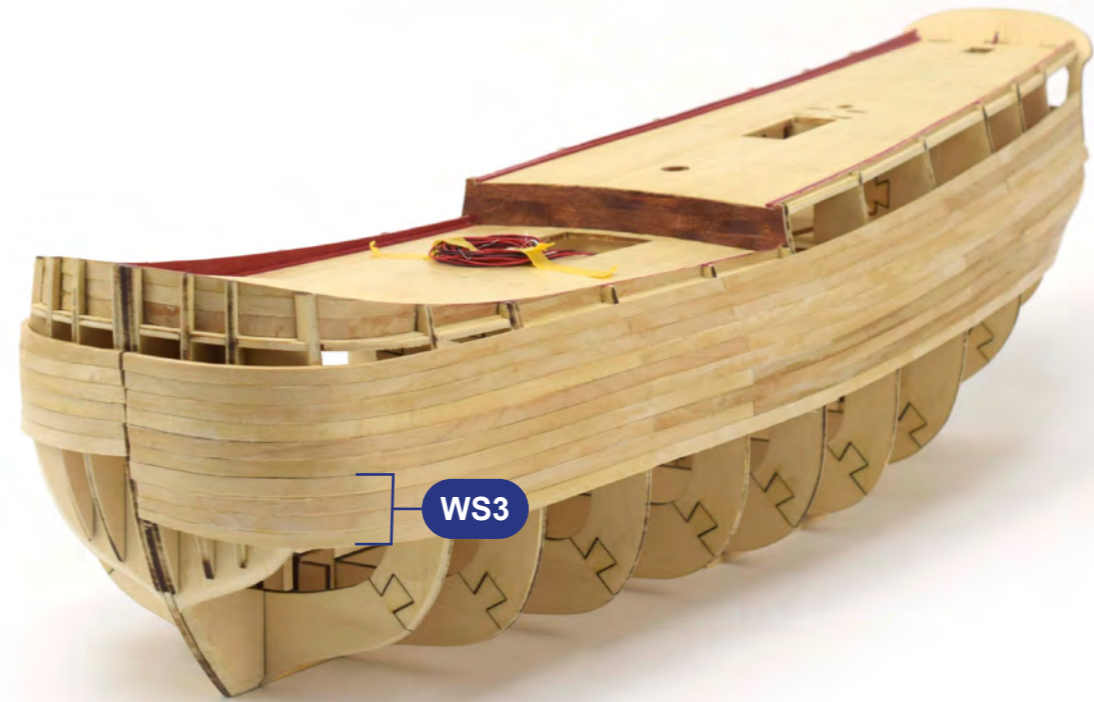

22



23

R

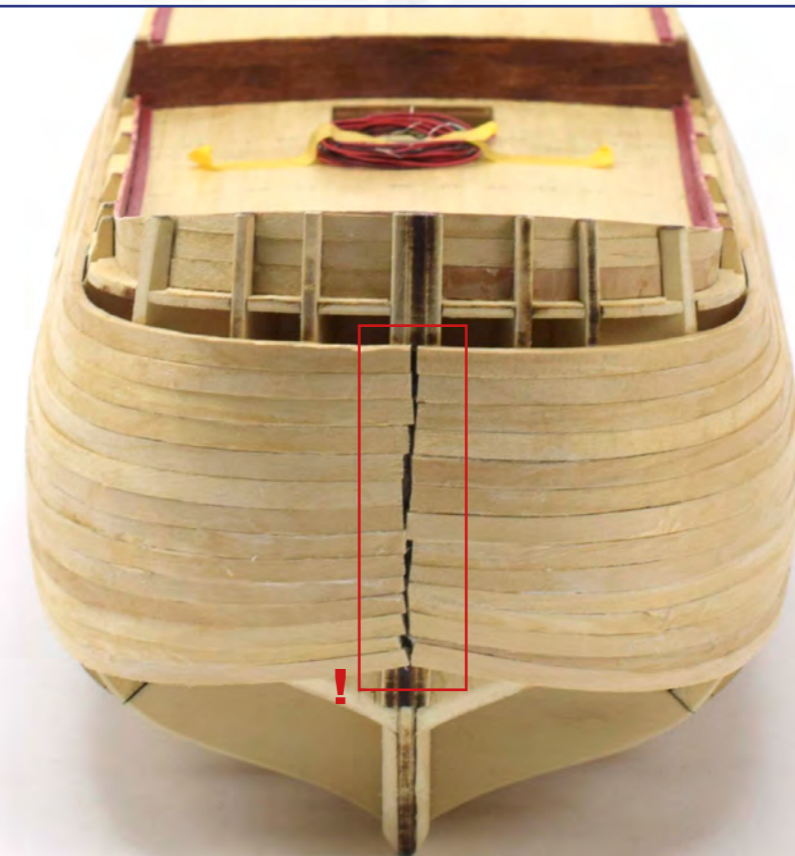

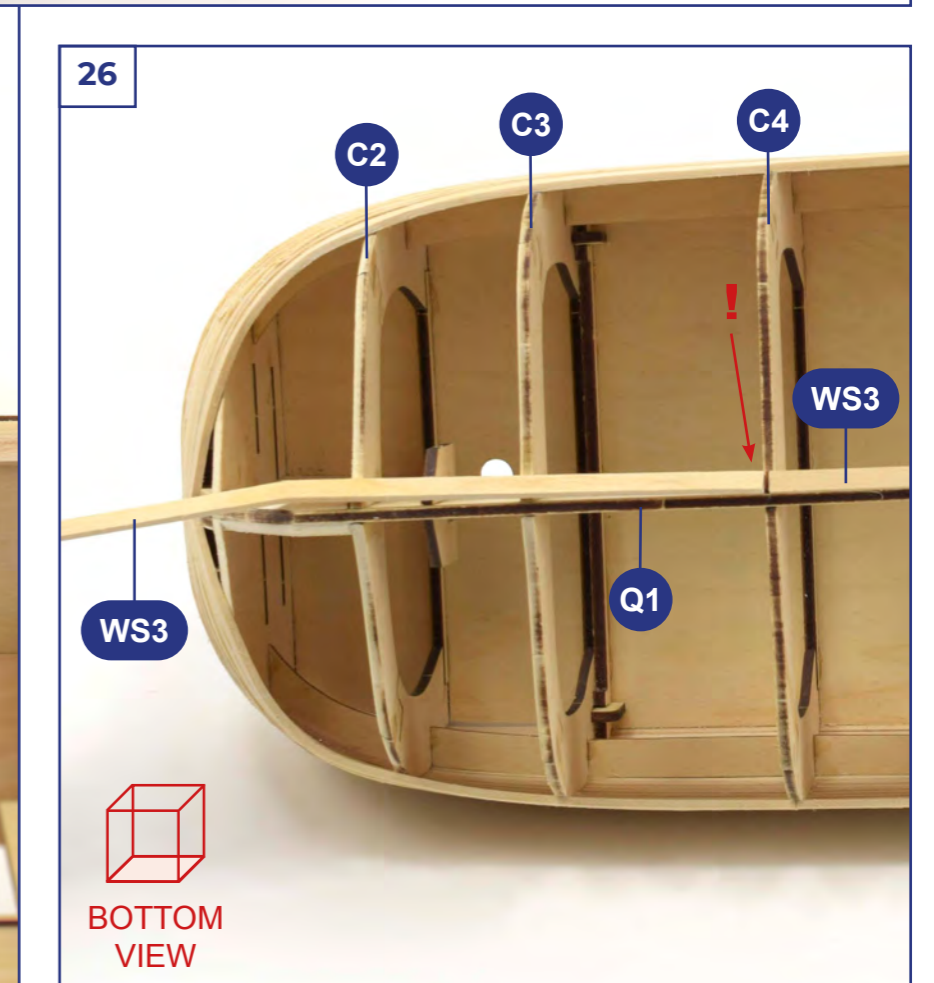
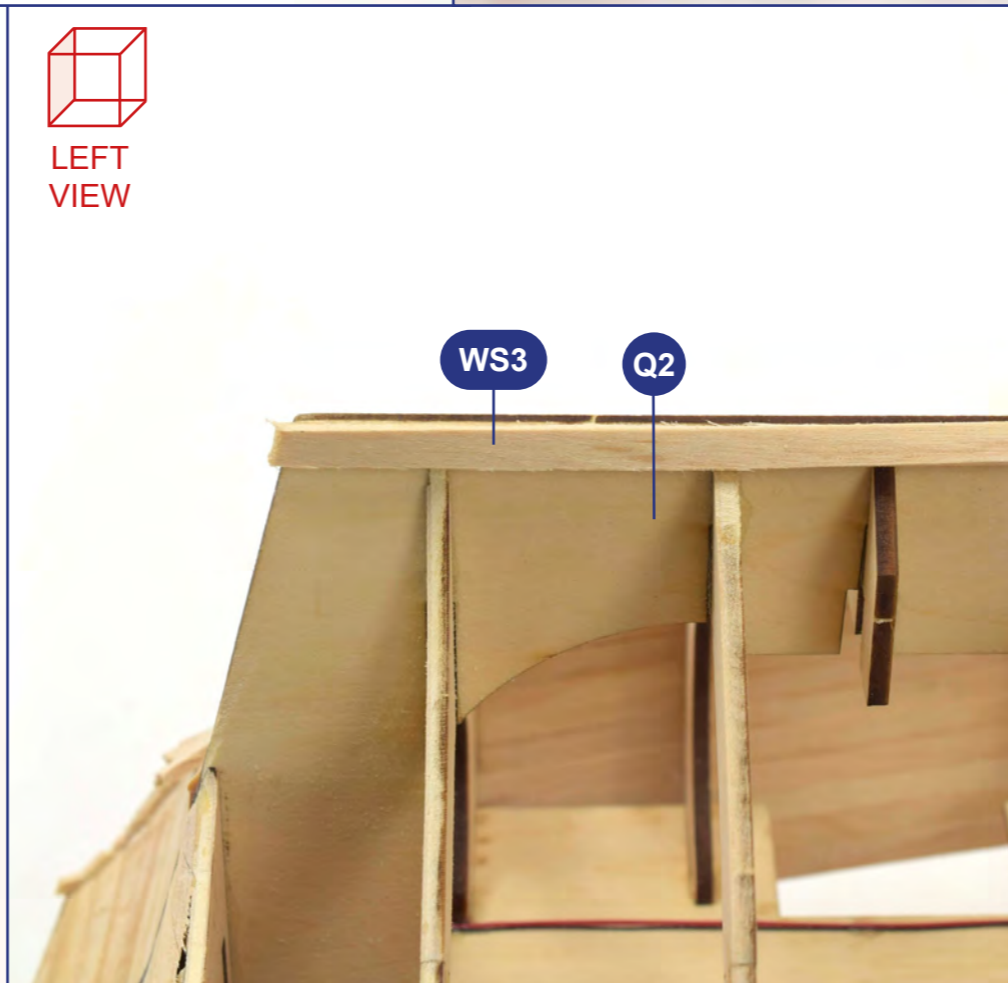
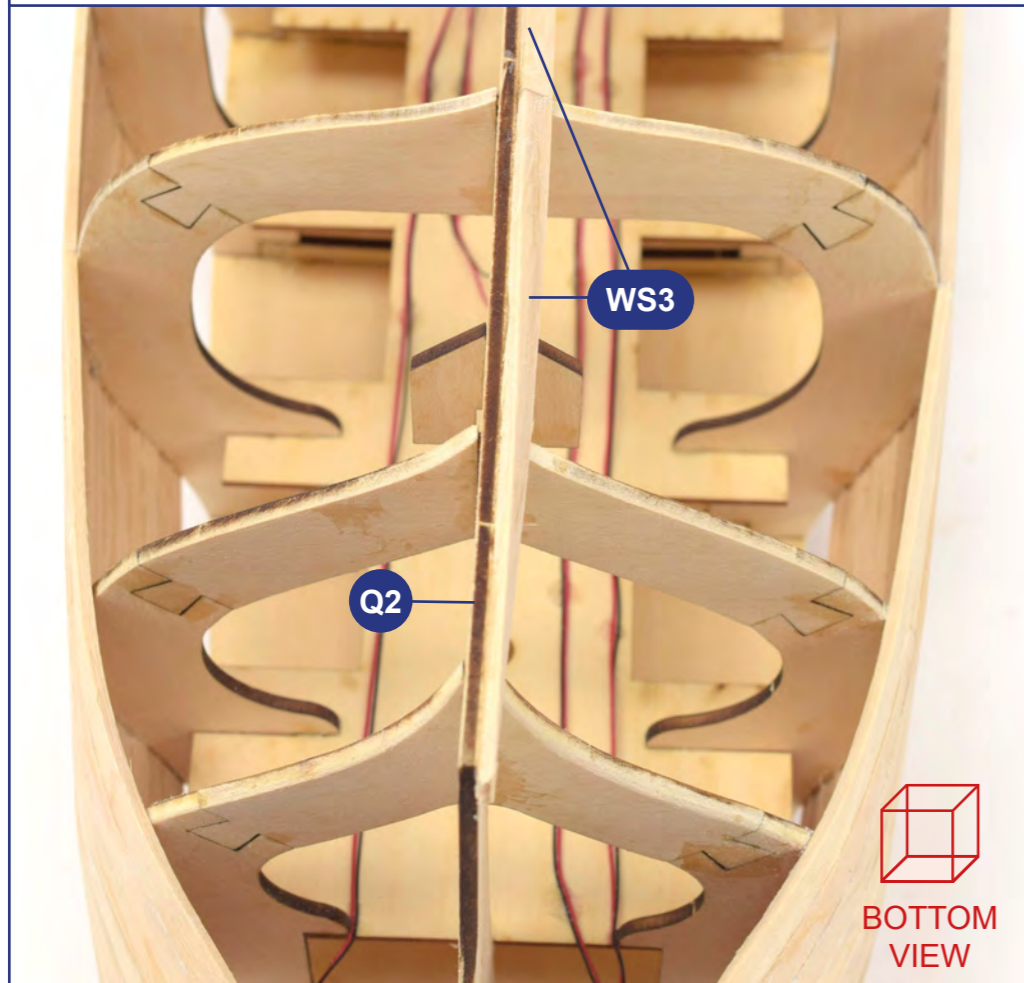
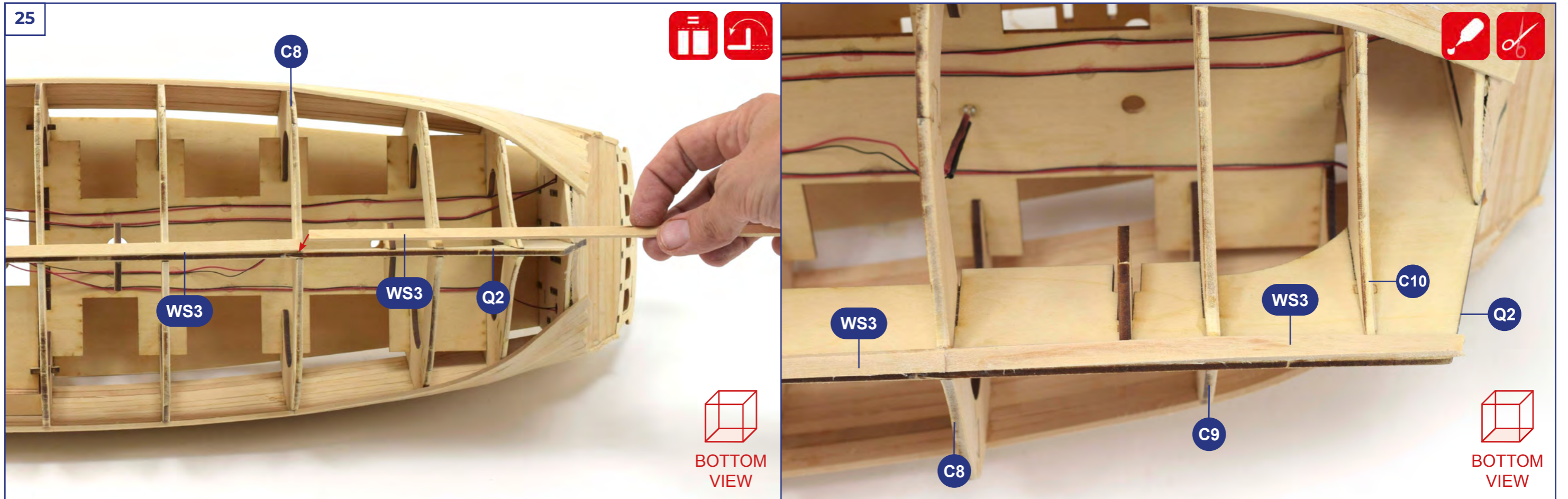

27

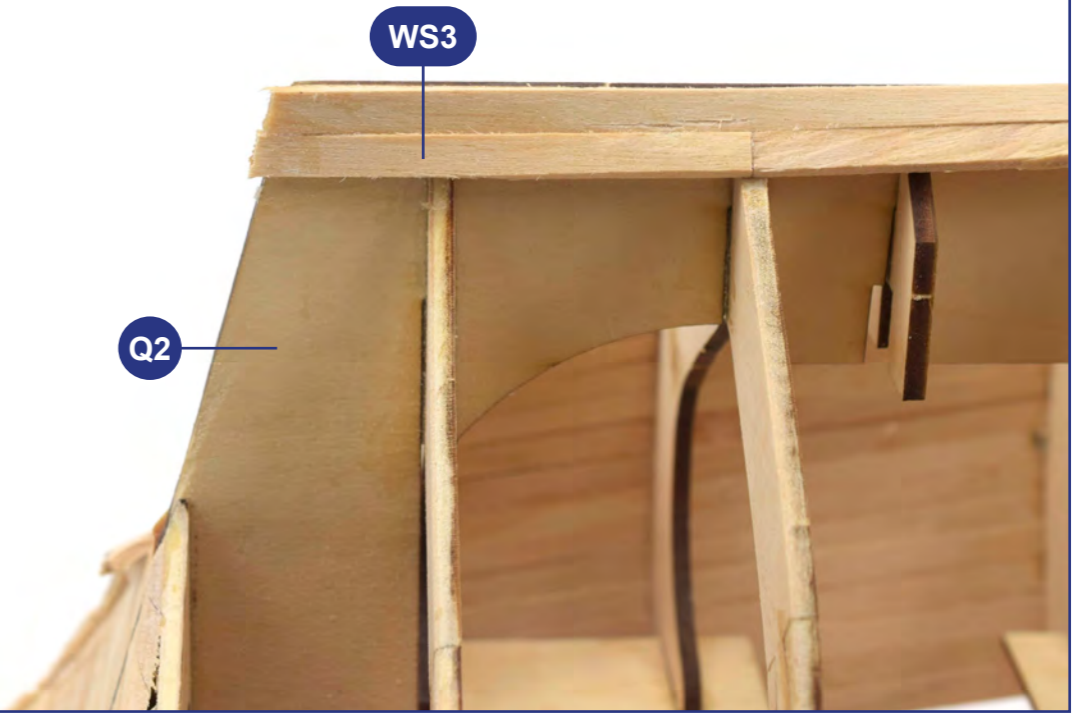
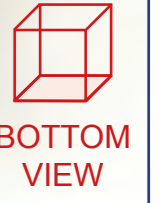

28

R

WS3



WS3



WS3

BOTTOM
VIEW

FRONT
VIEW

29

R

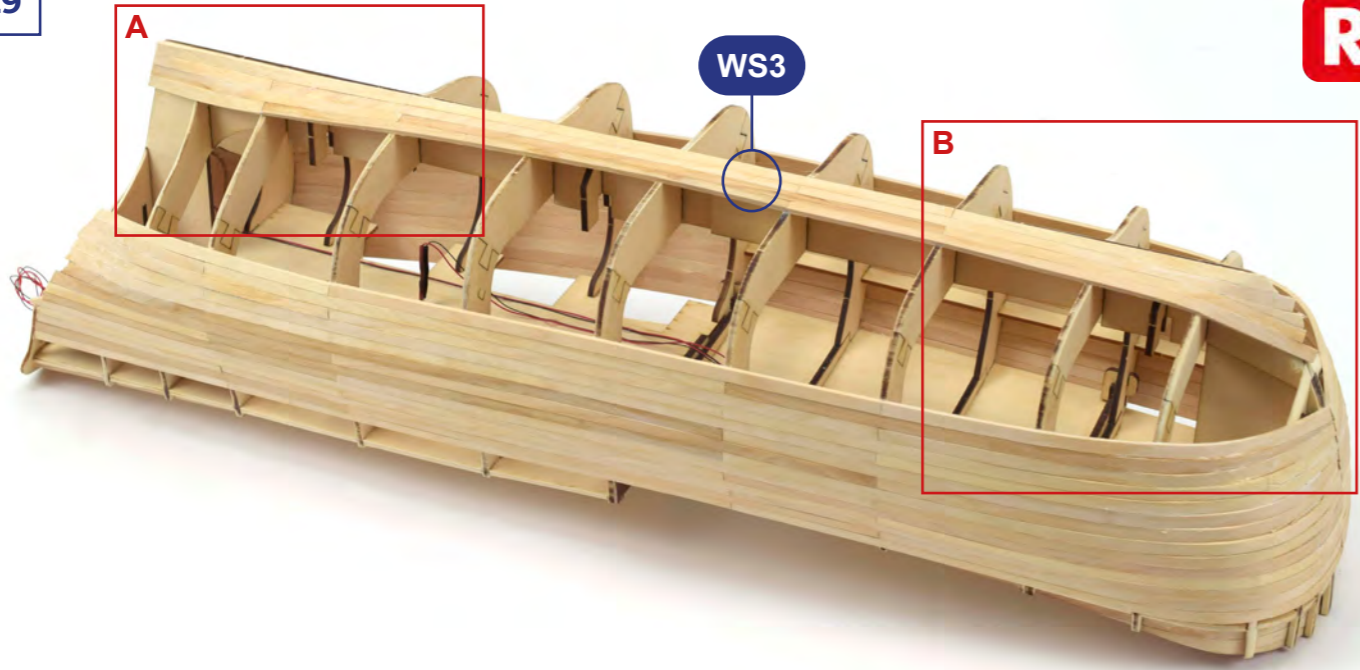

30

R

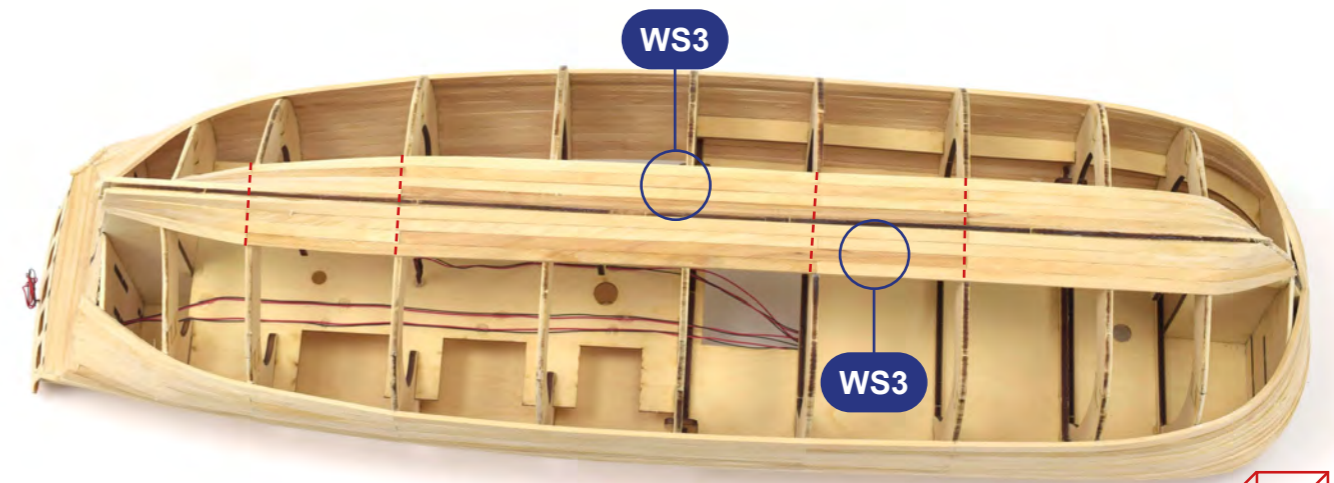

BOTTOM VIEW

A

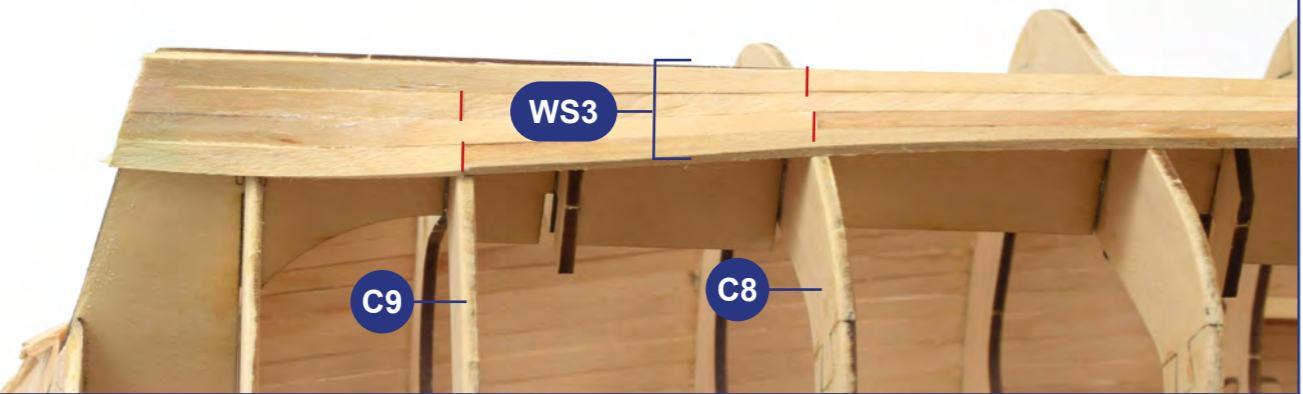

B

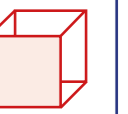
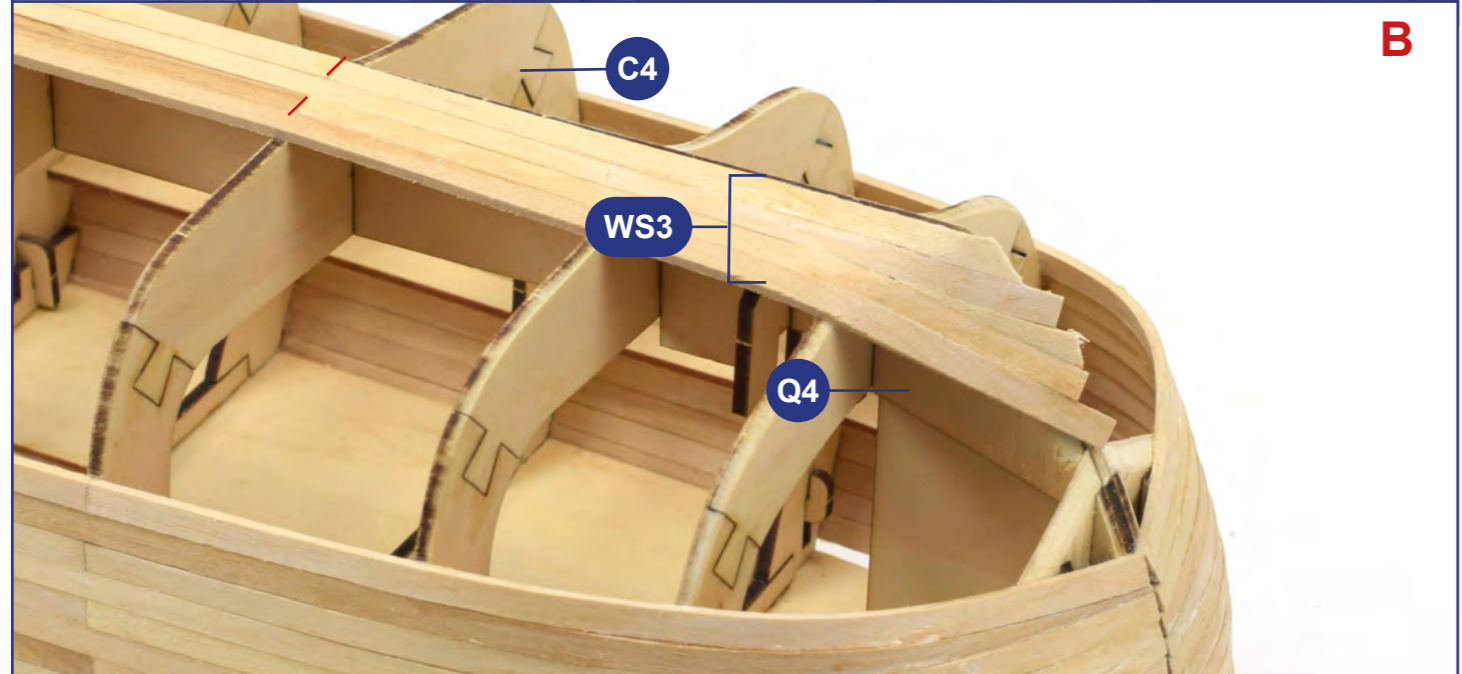

FRONT VIEW

31

R

A



A

WS3

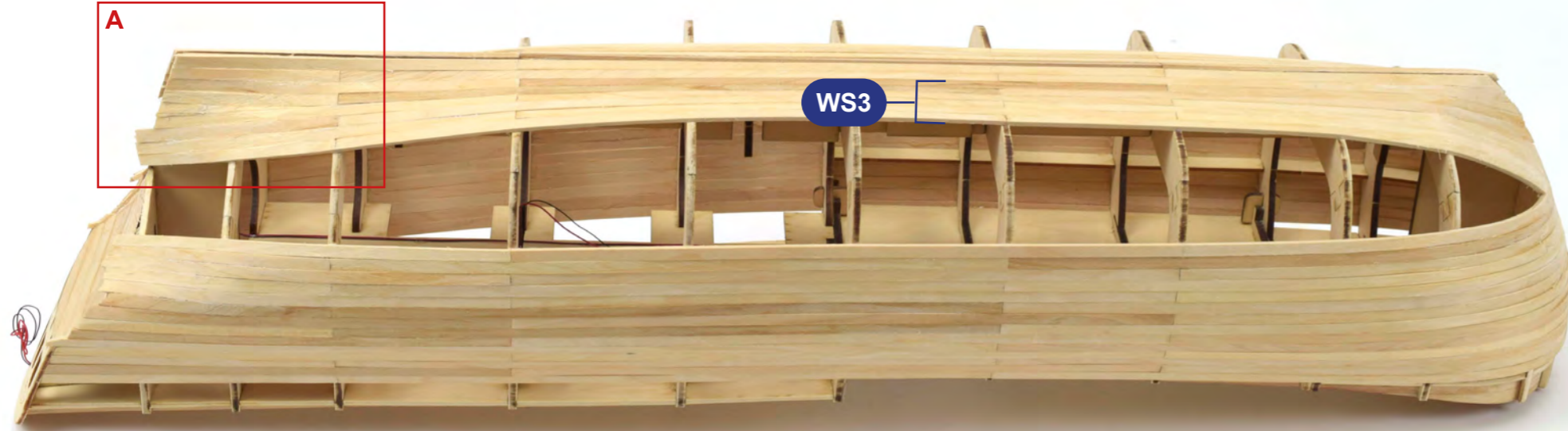

WS3

C9

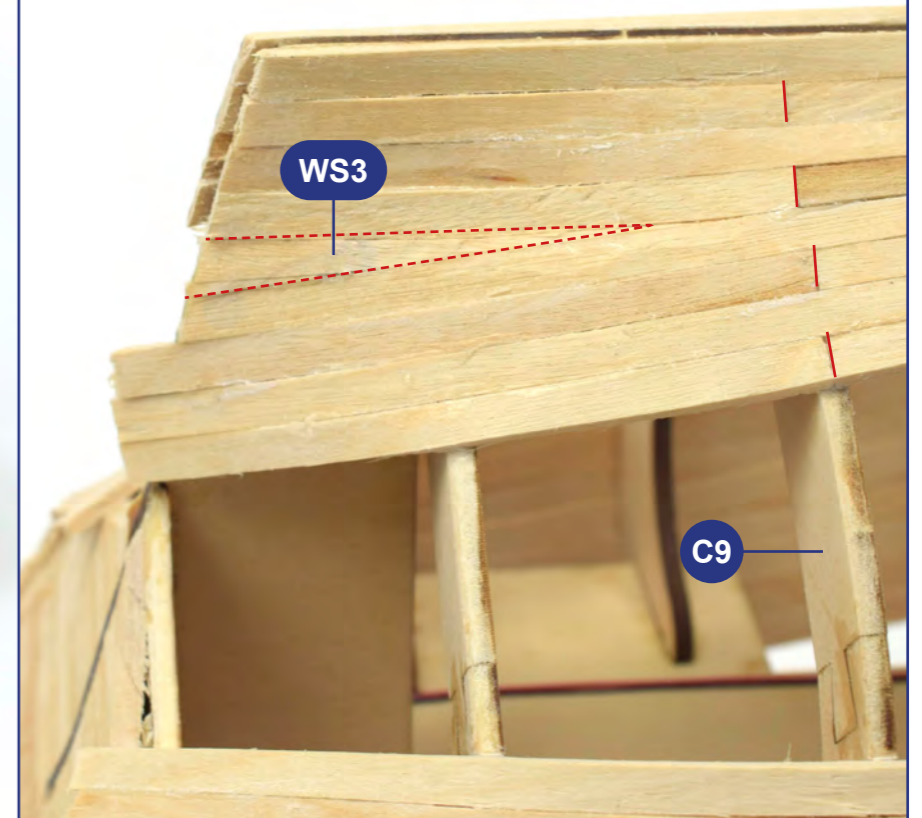

BOTTOM VIEW

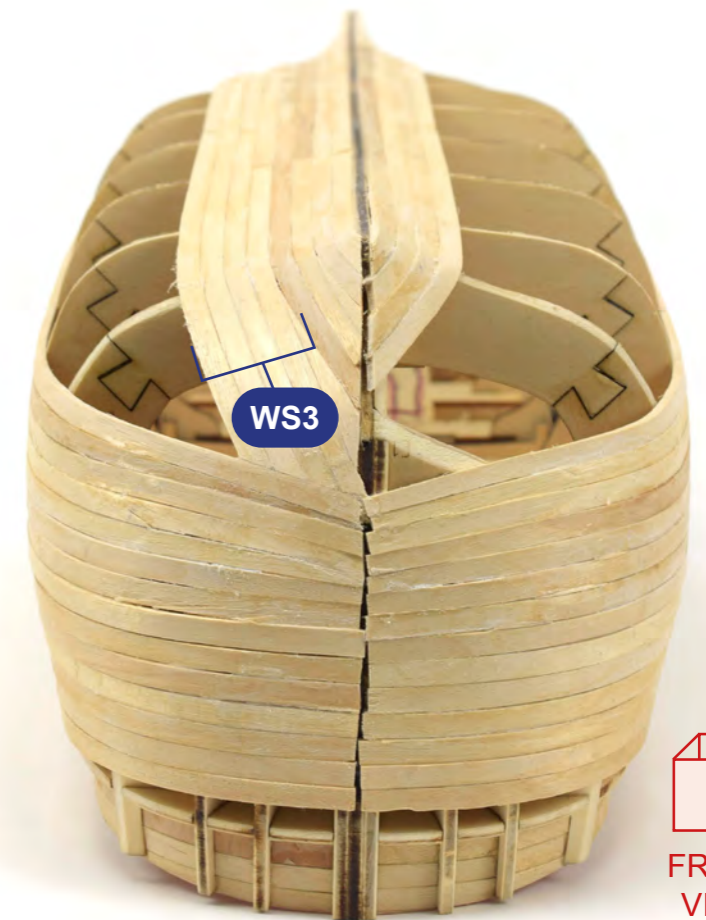

FRONT VIEW

32



33

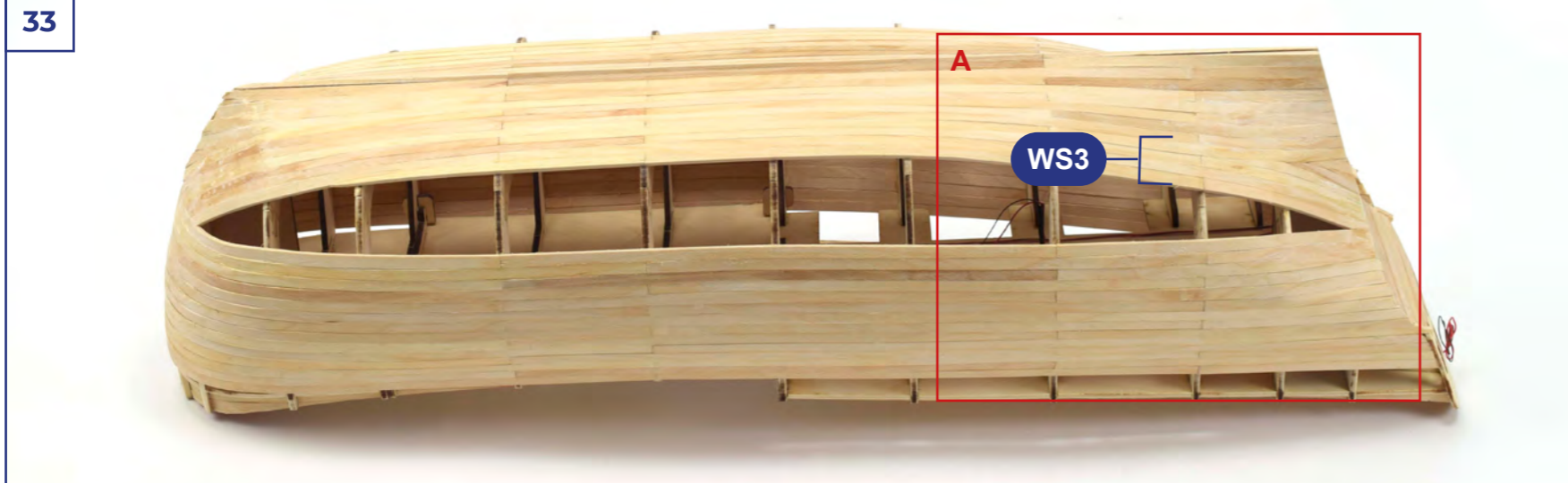

34

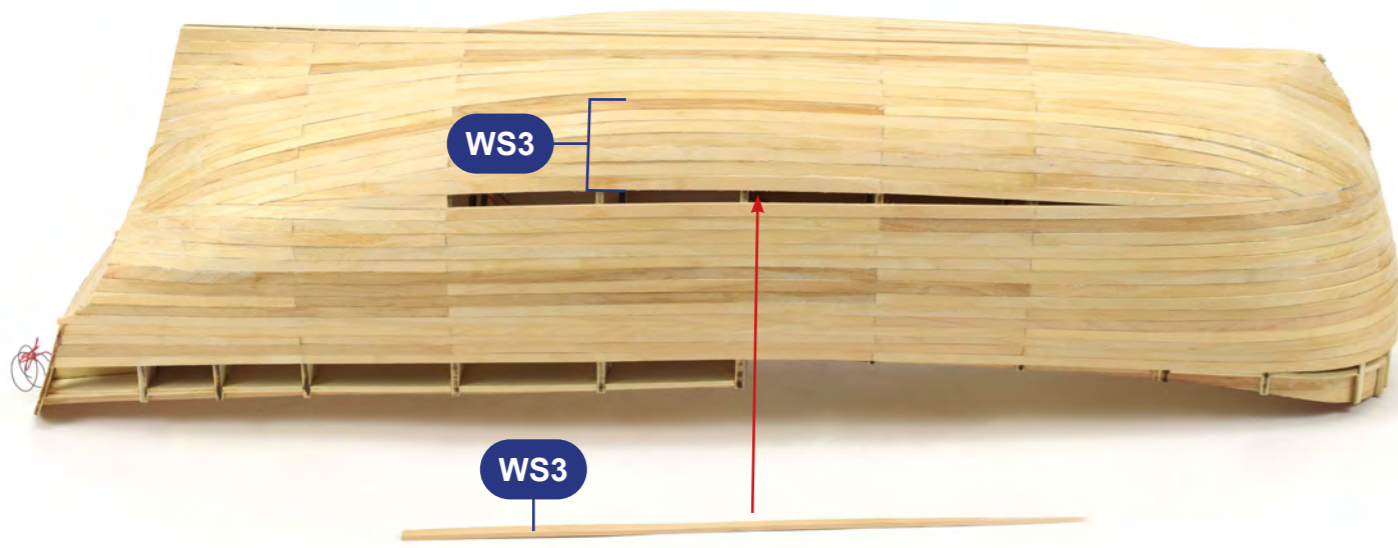

LEFT VIEW

35



FRONT VIEW

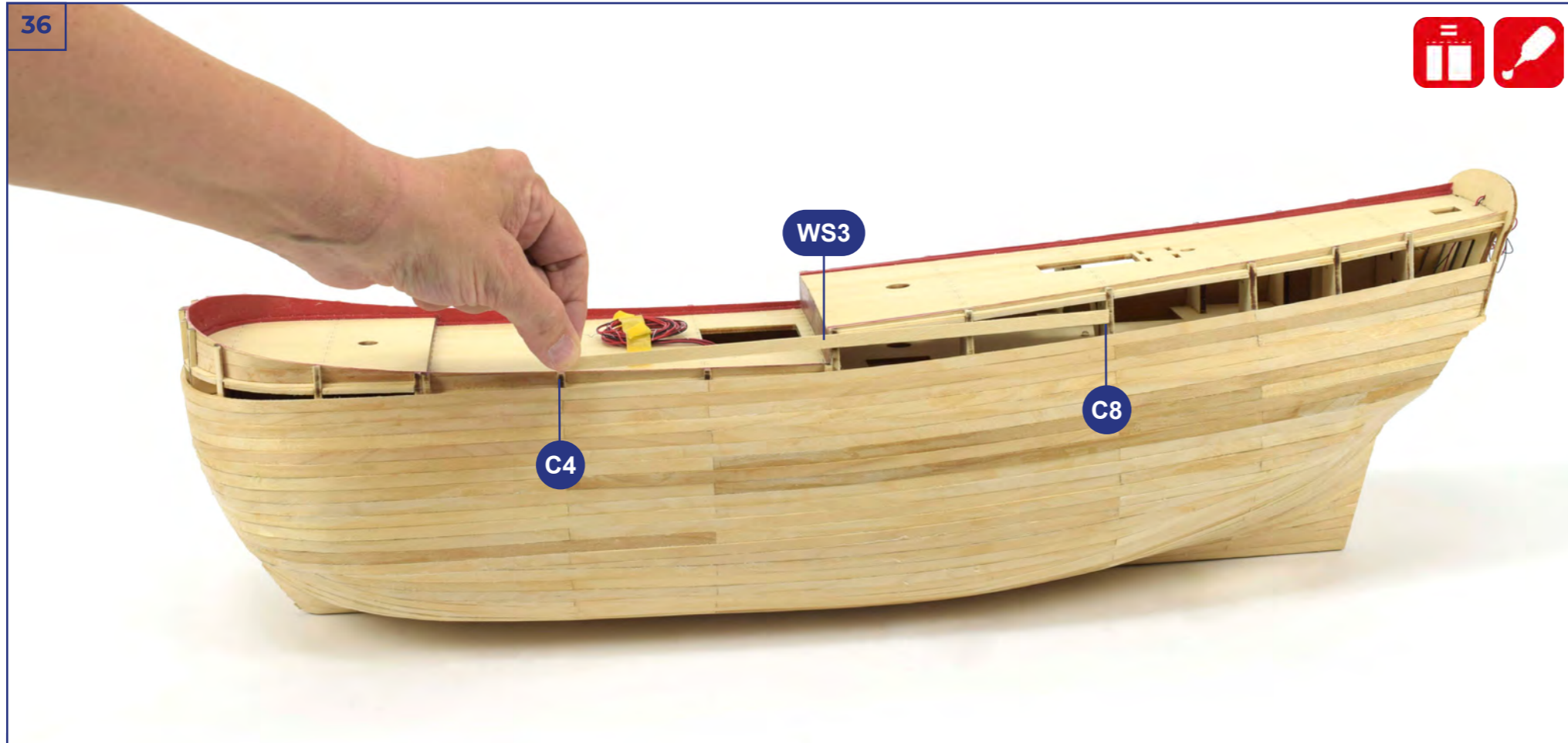

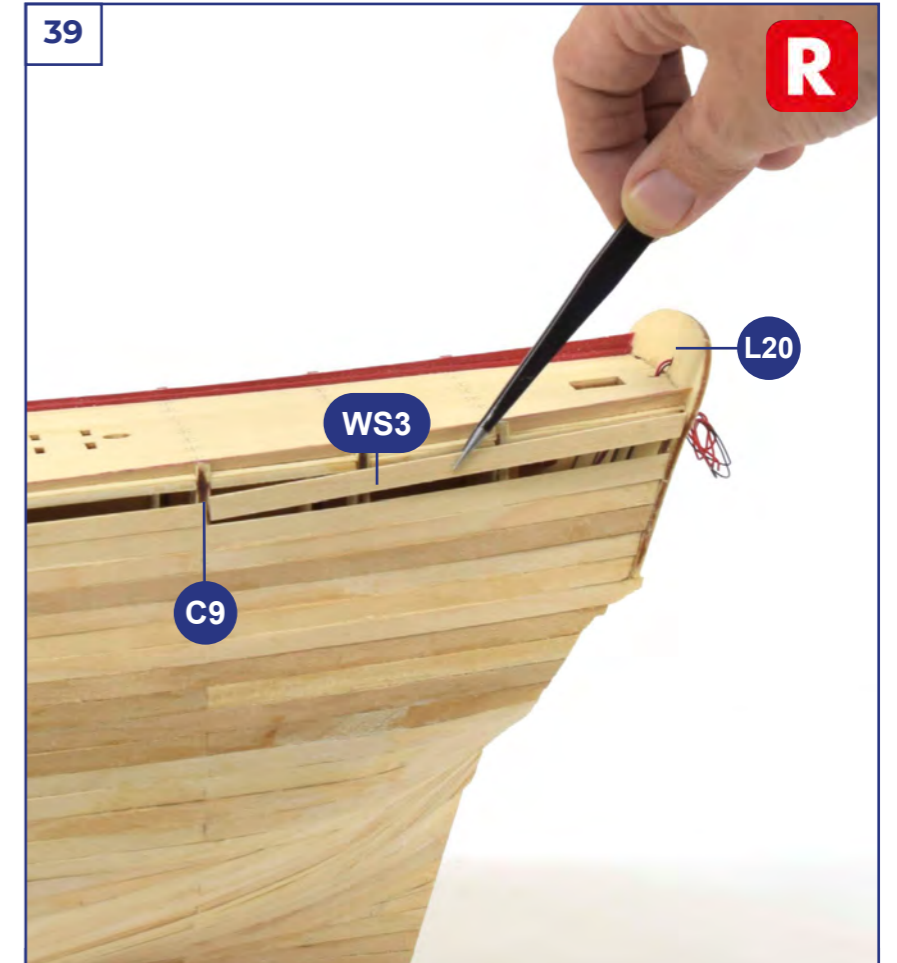
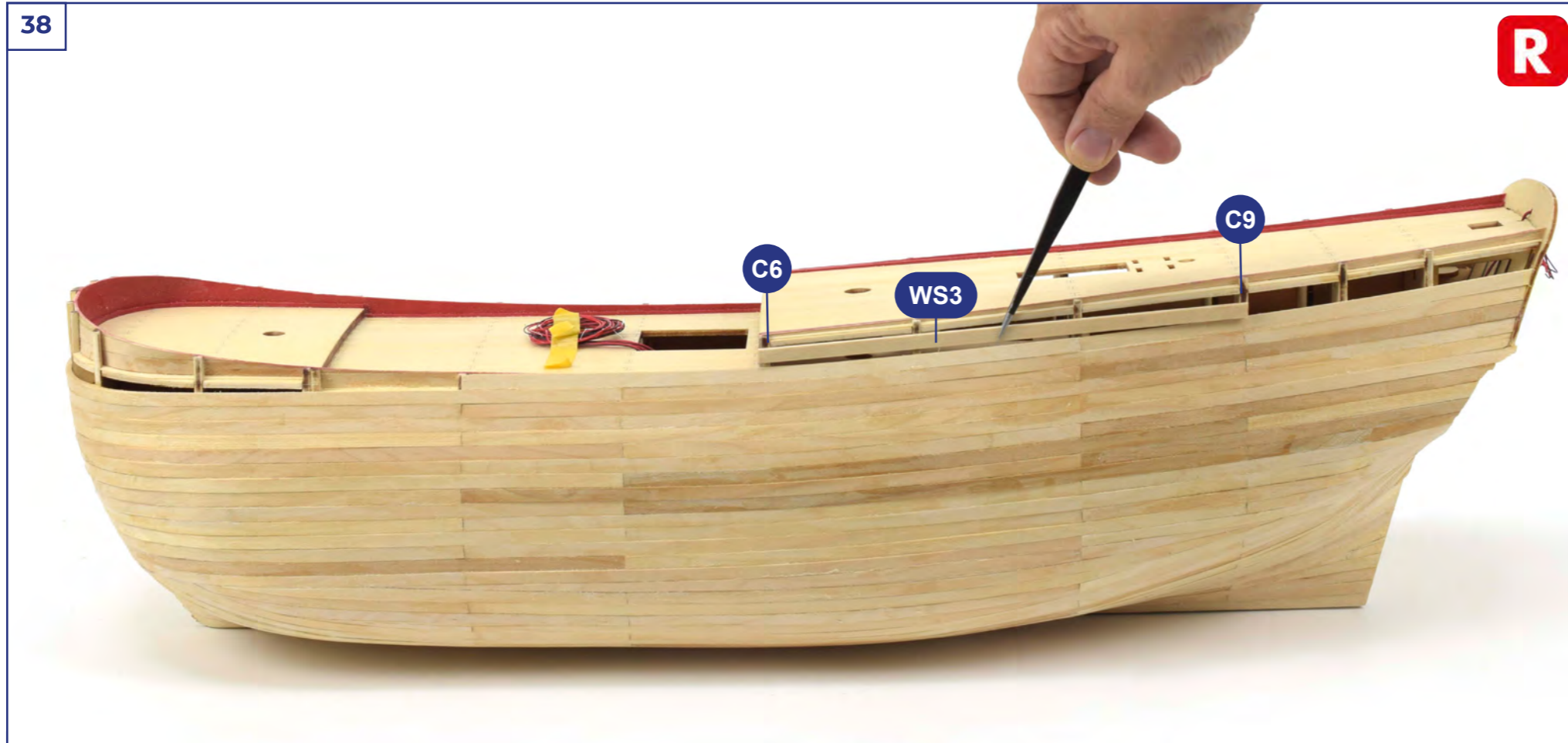

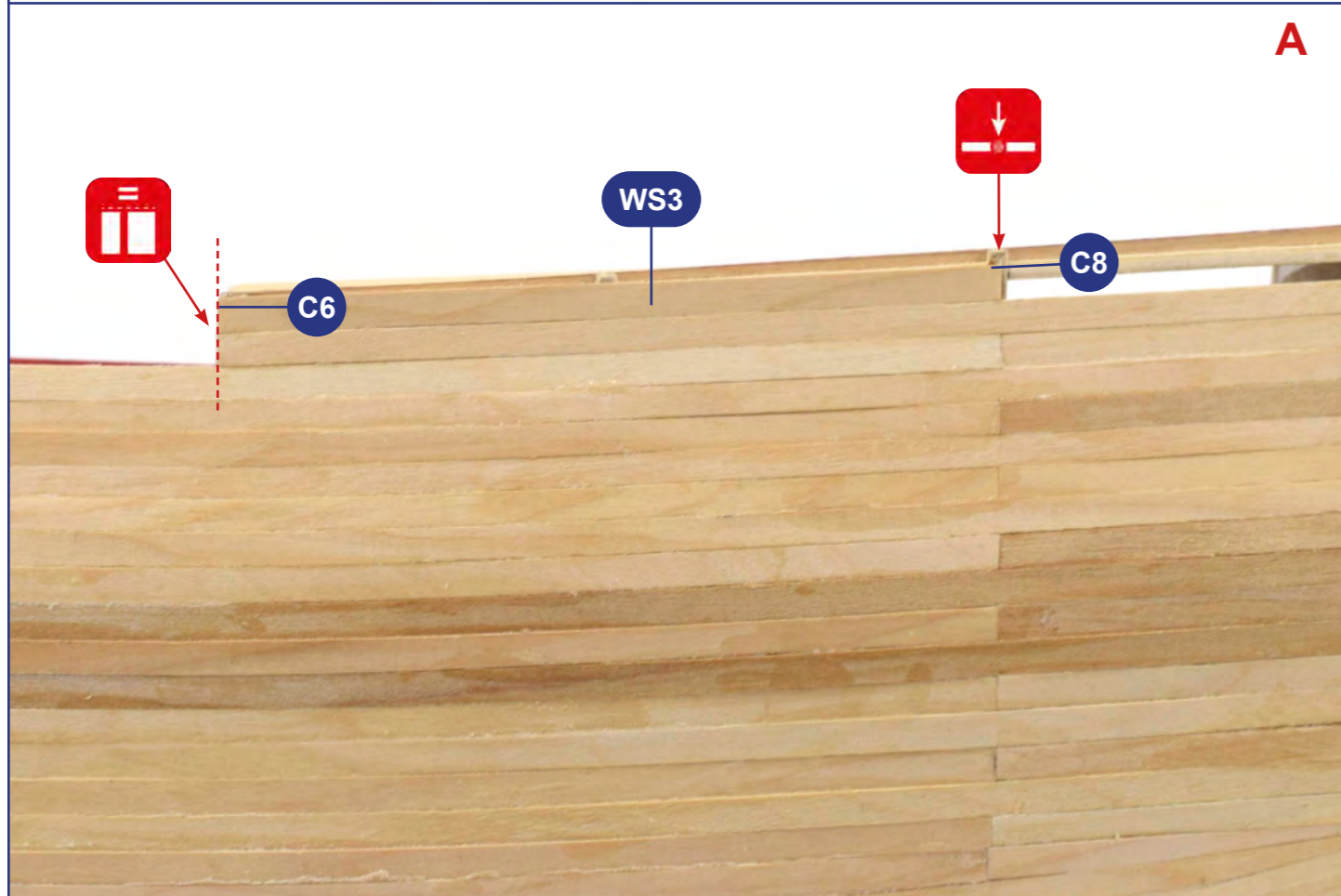
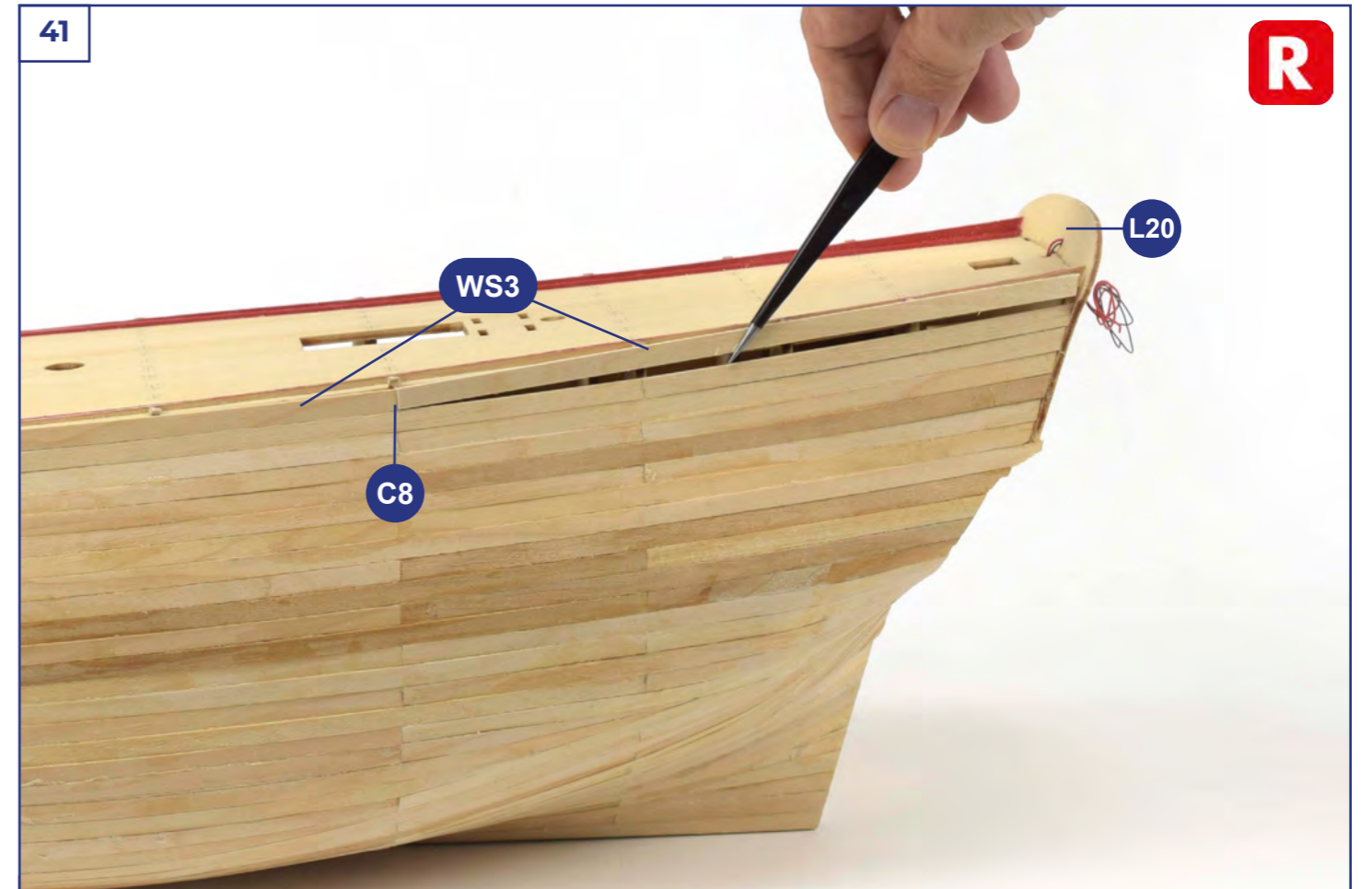
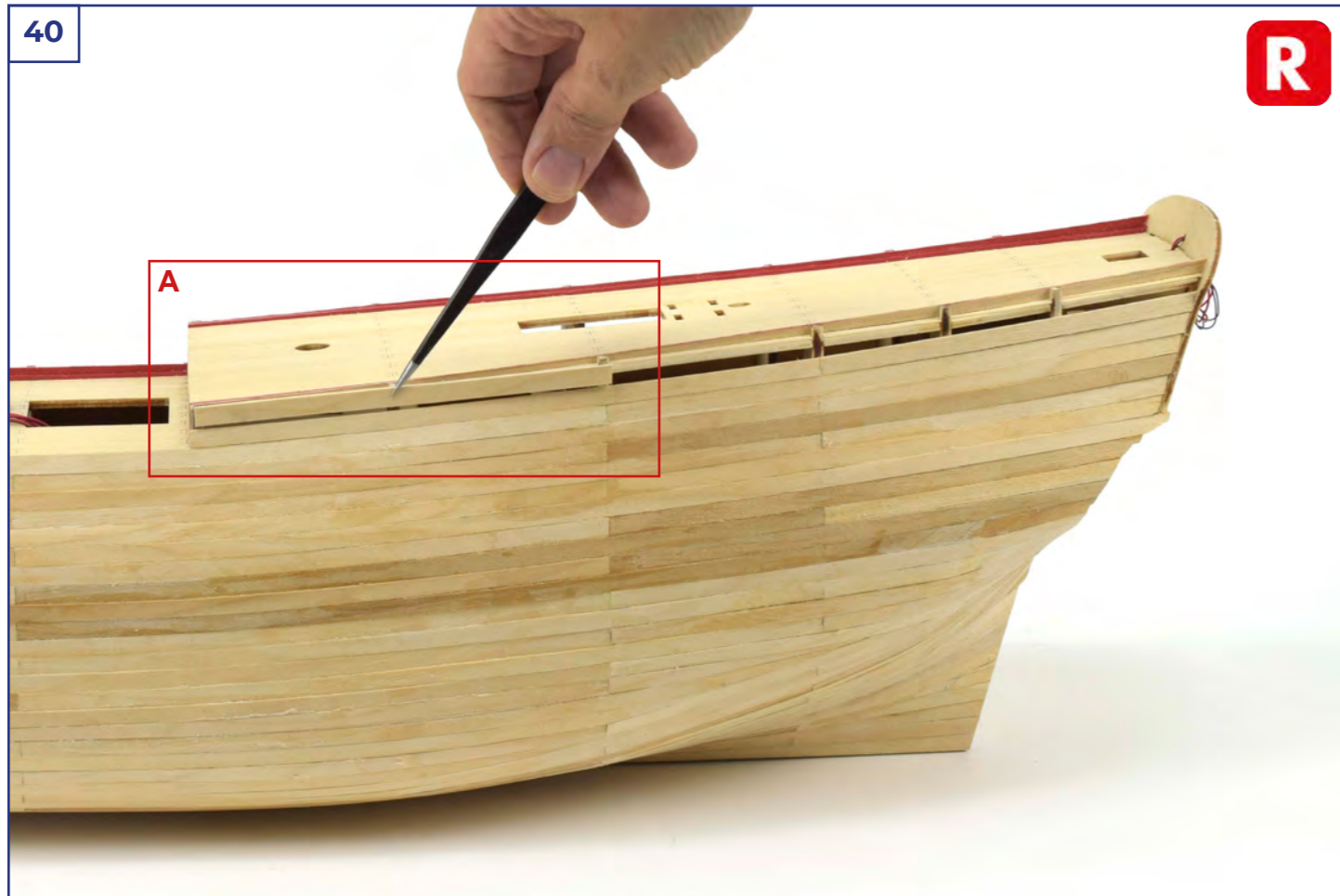

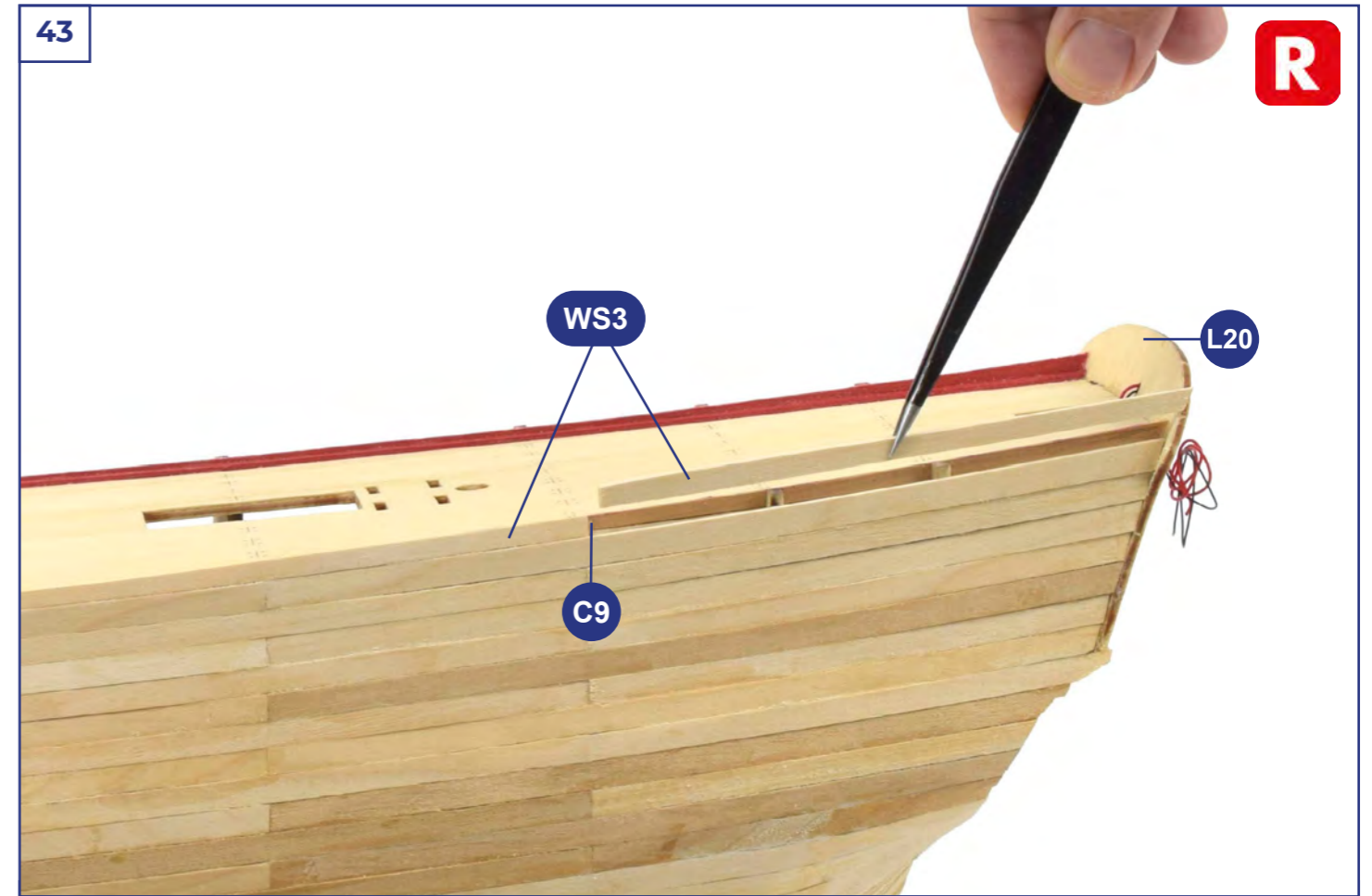
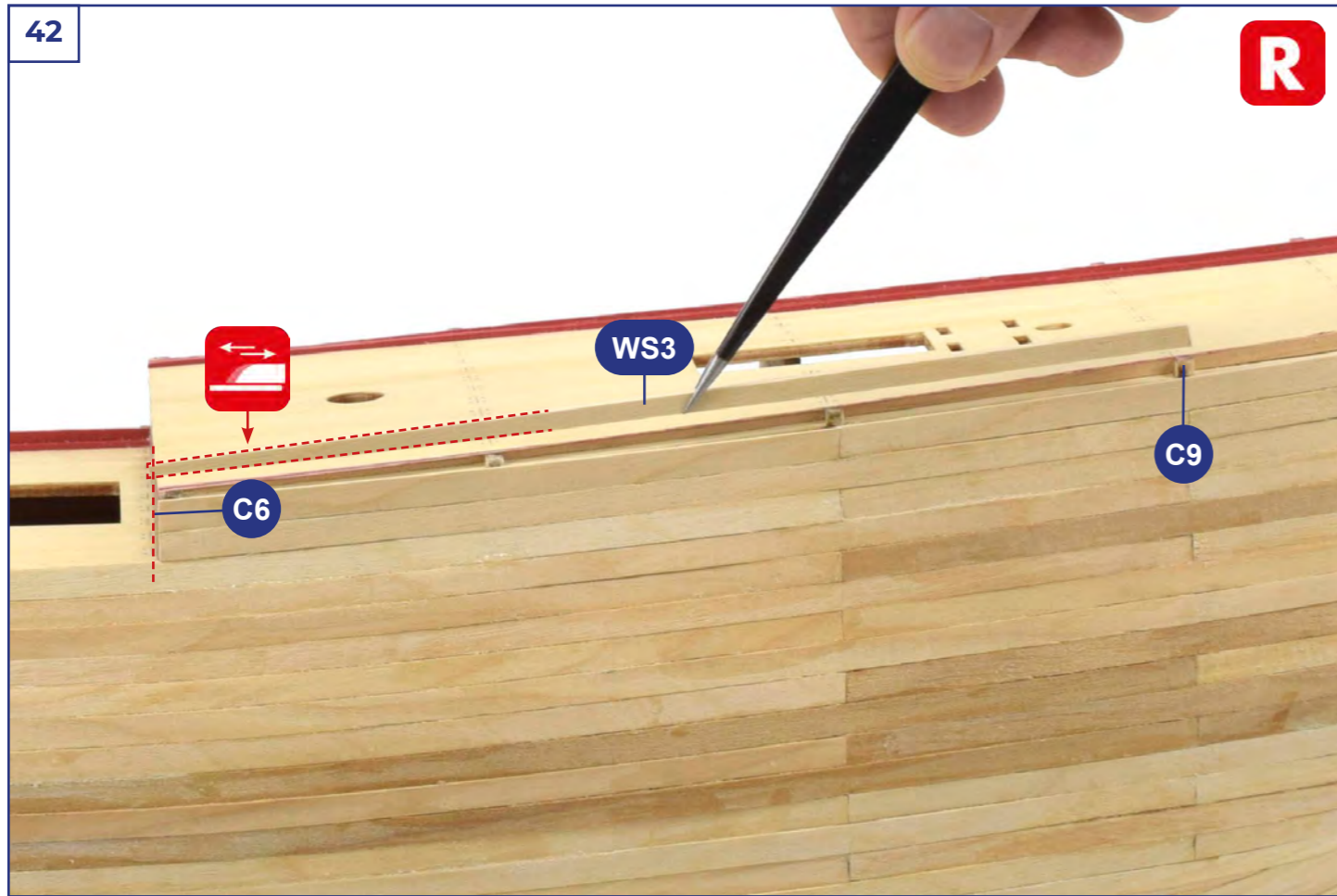

44

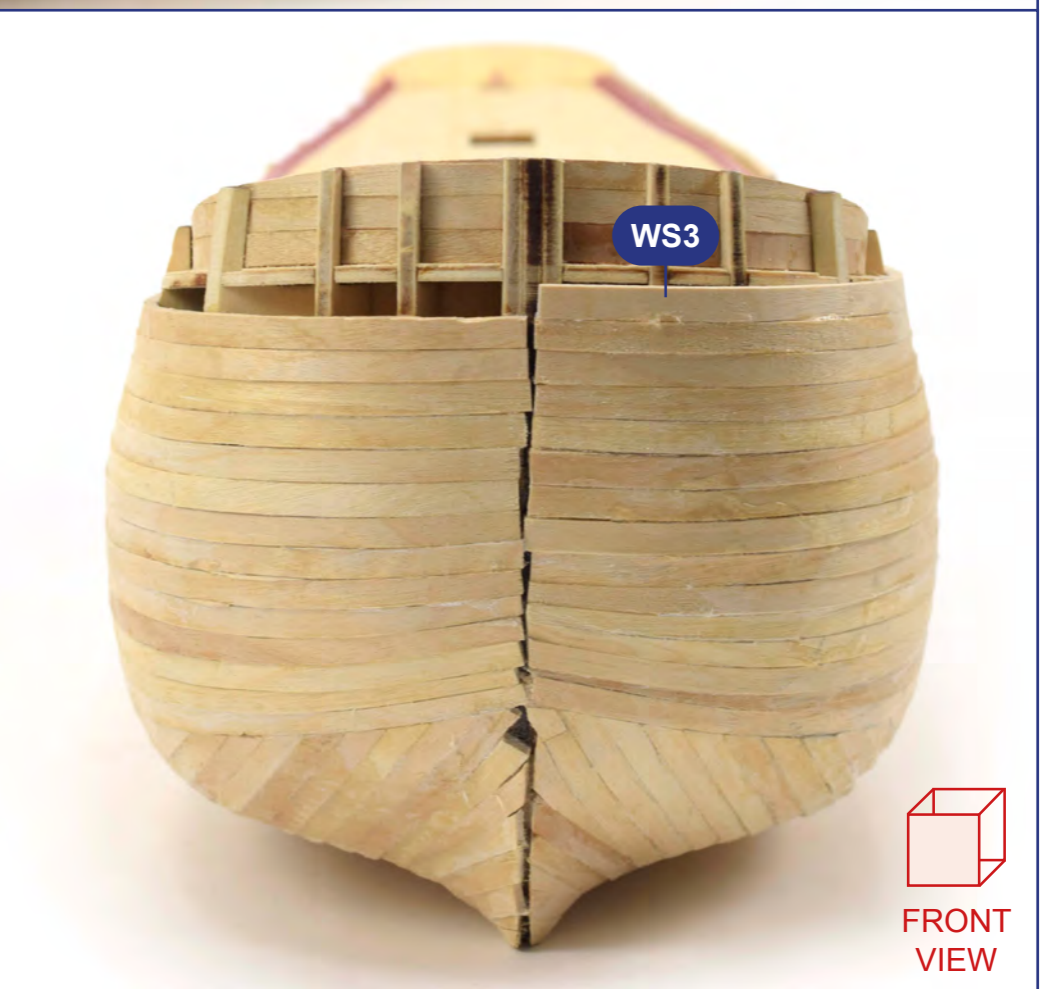
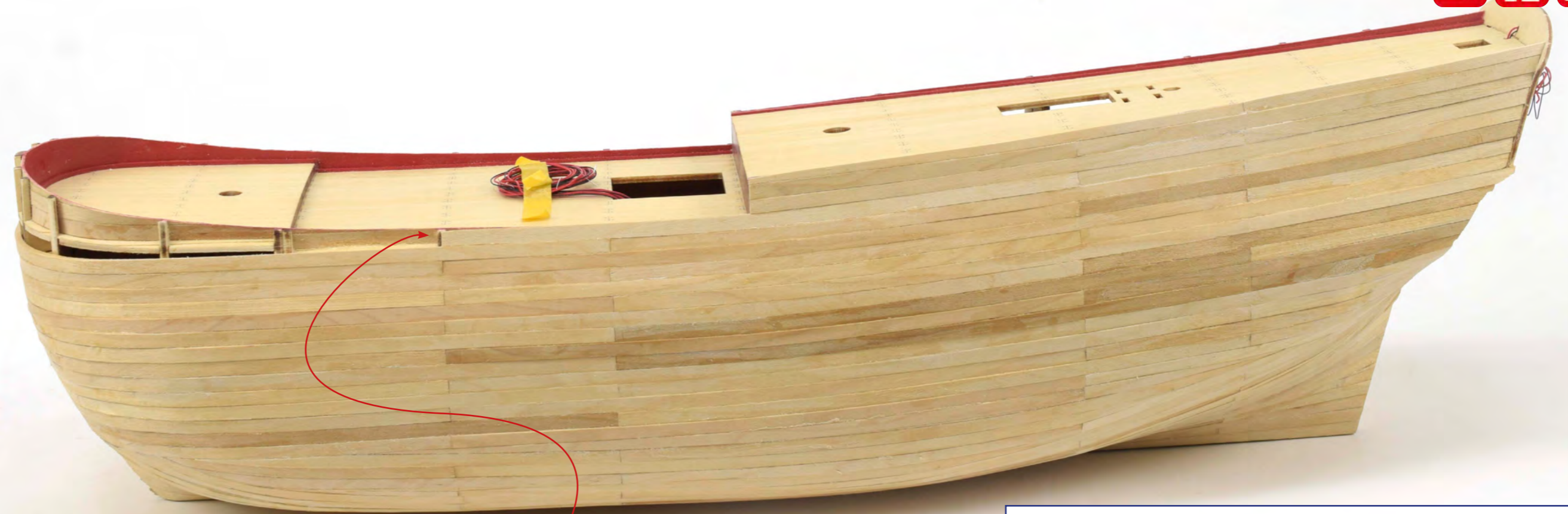

FRONT VIEW

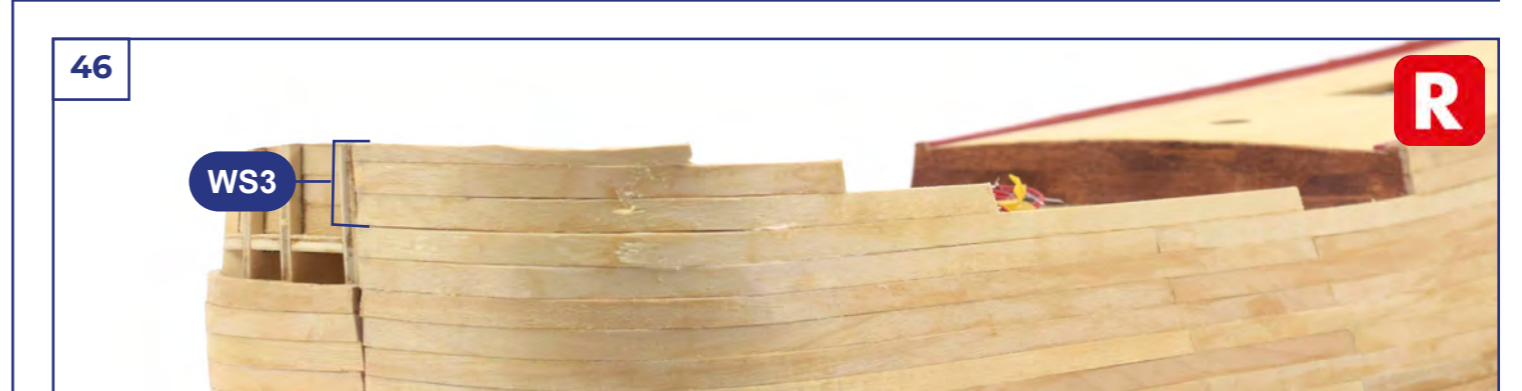
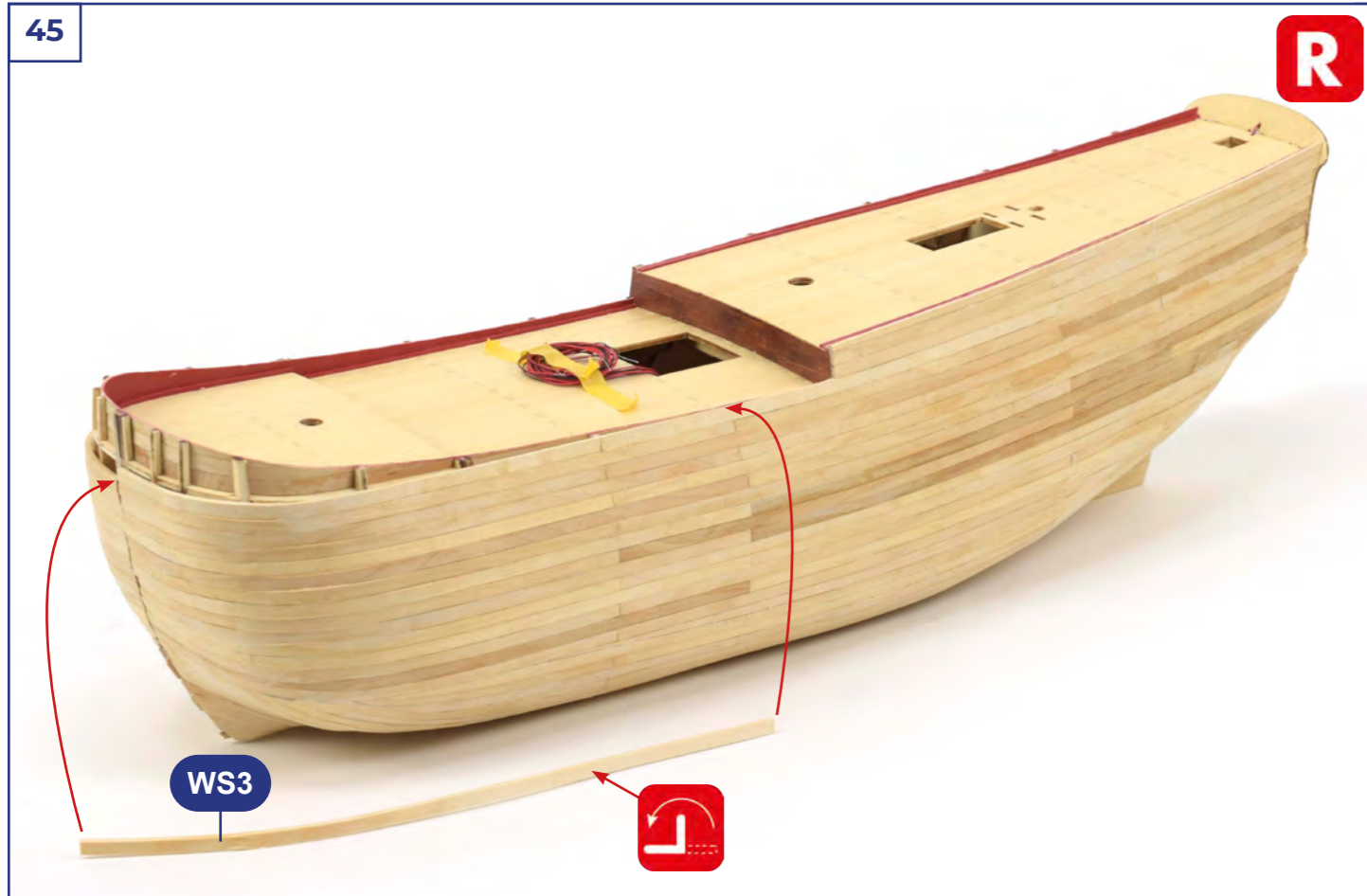

48

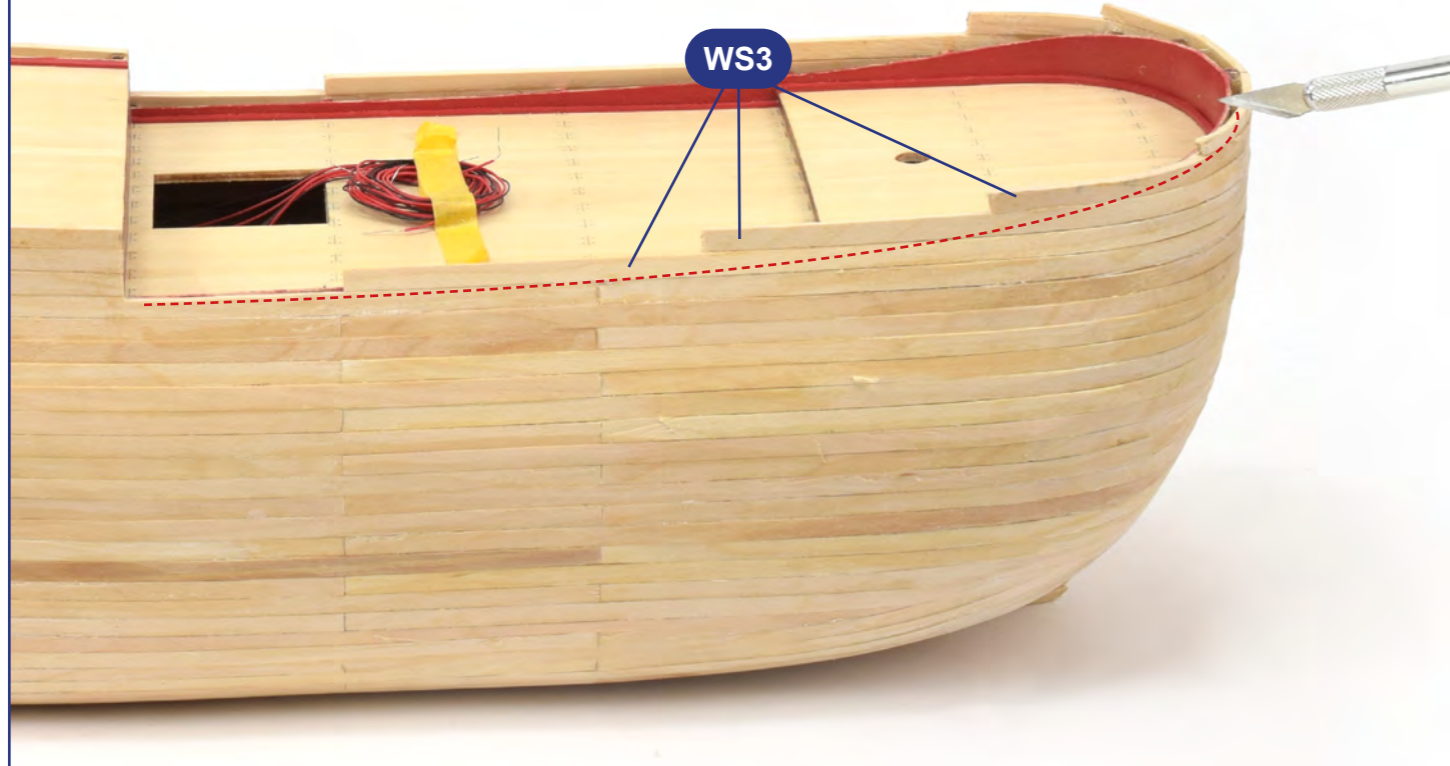

49



50



51



52



01

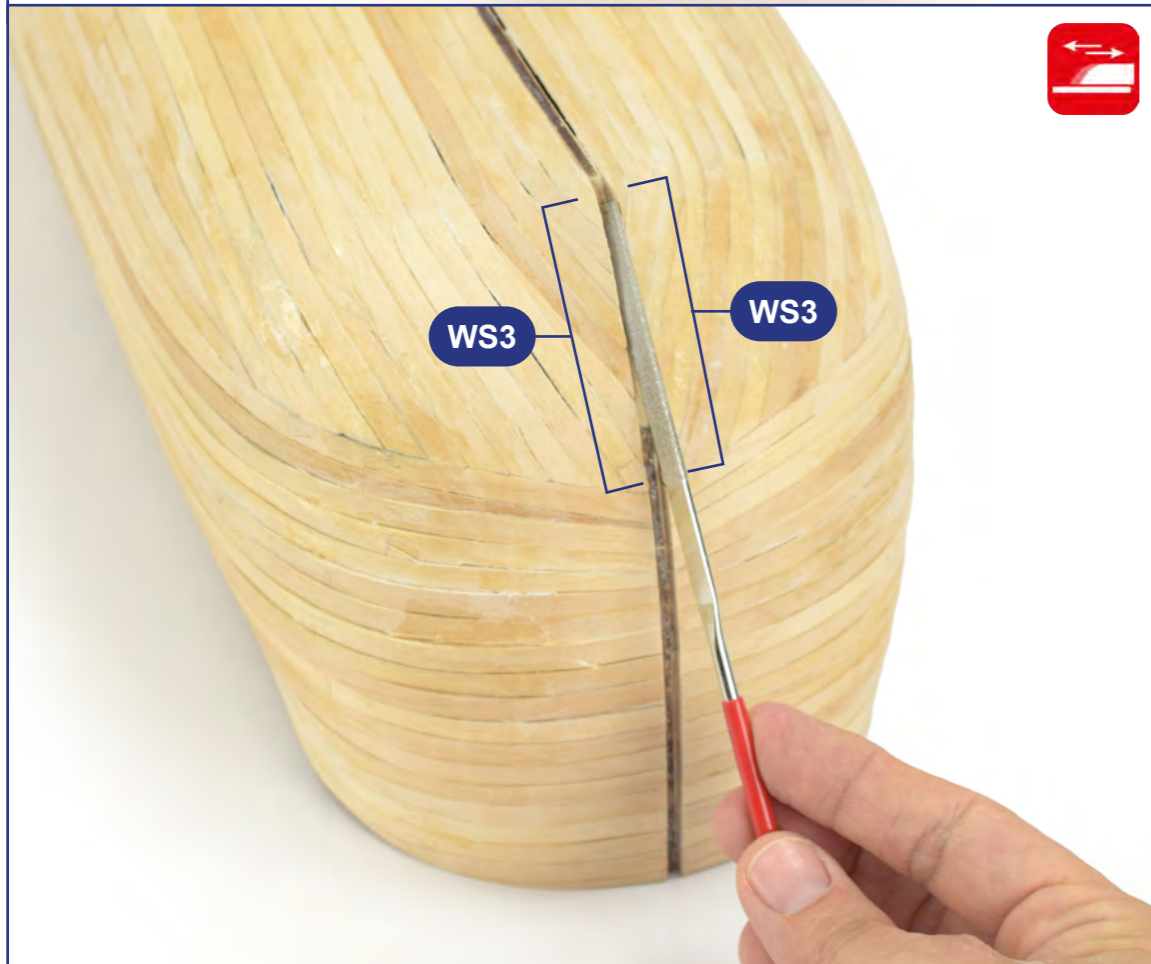
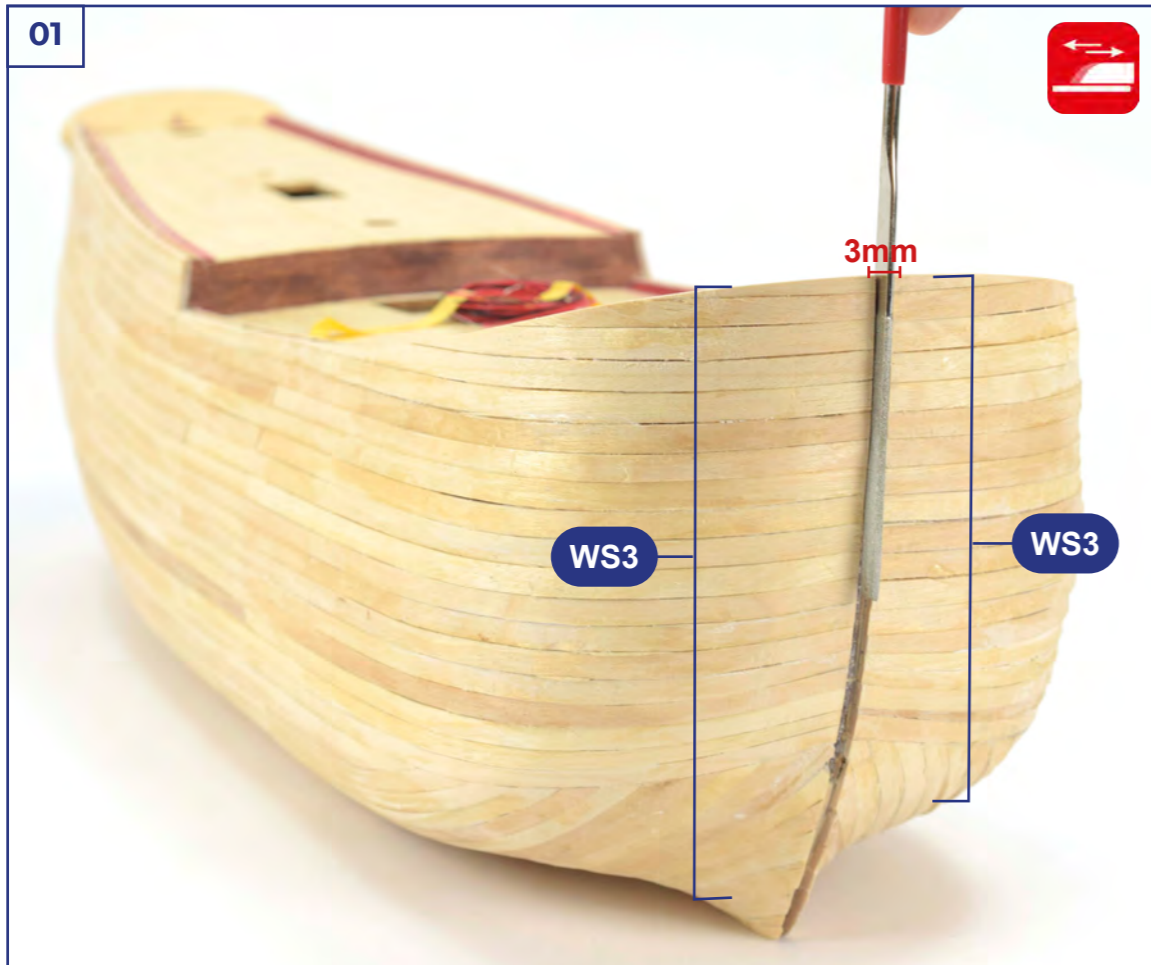

02

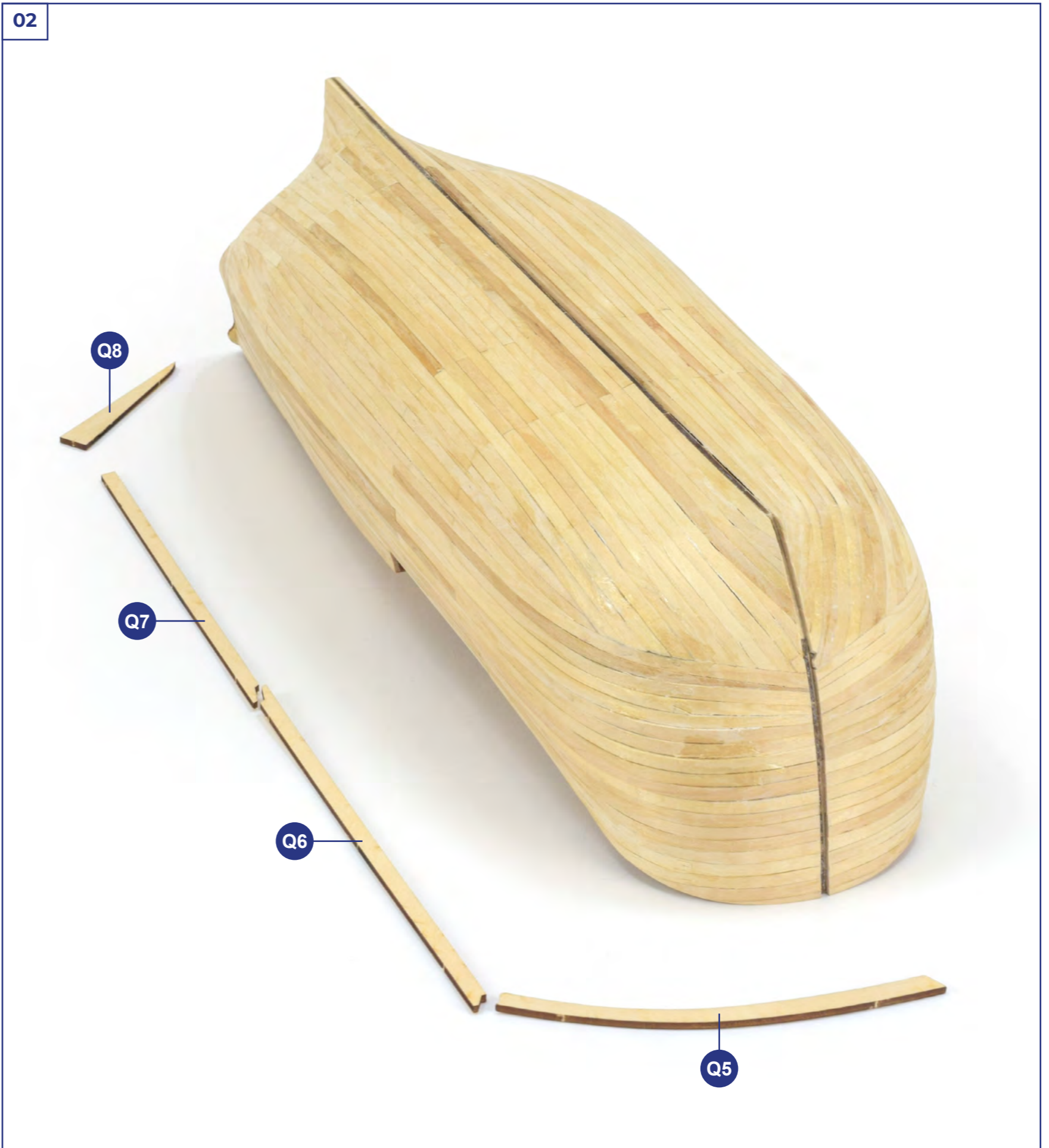

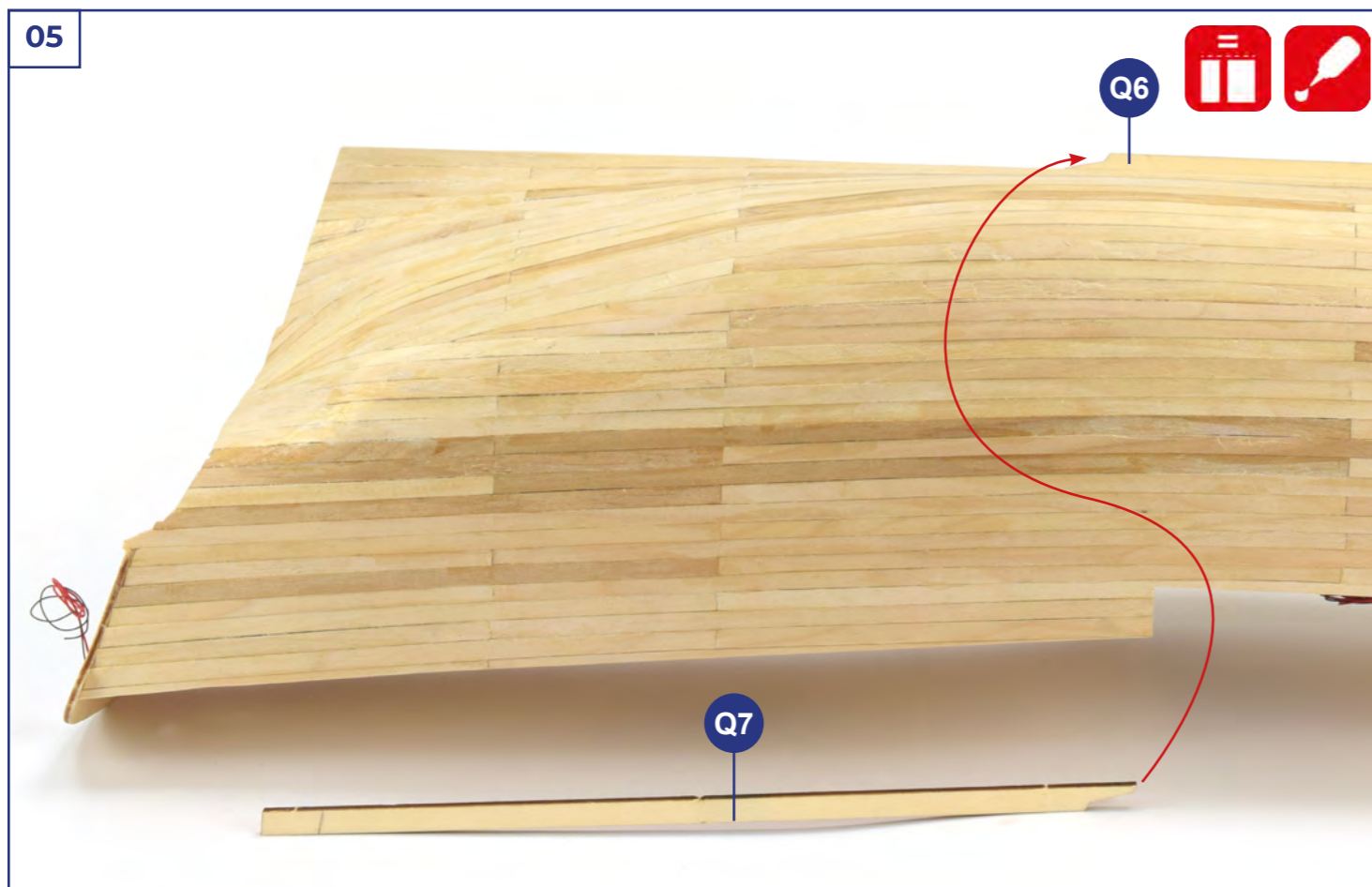

06

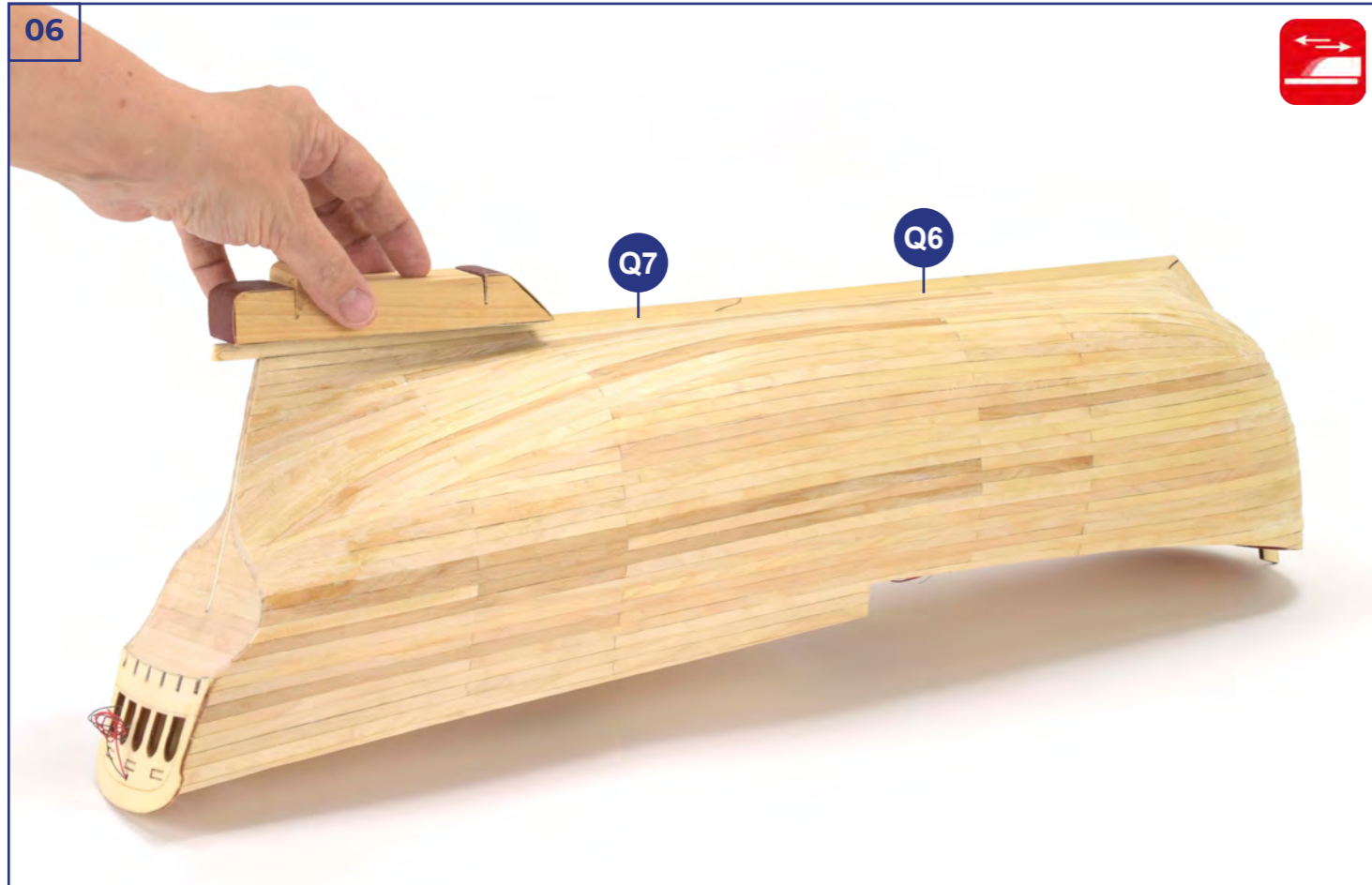

07

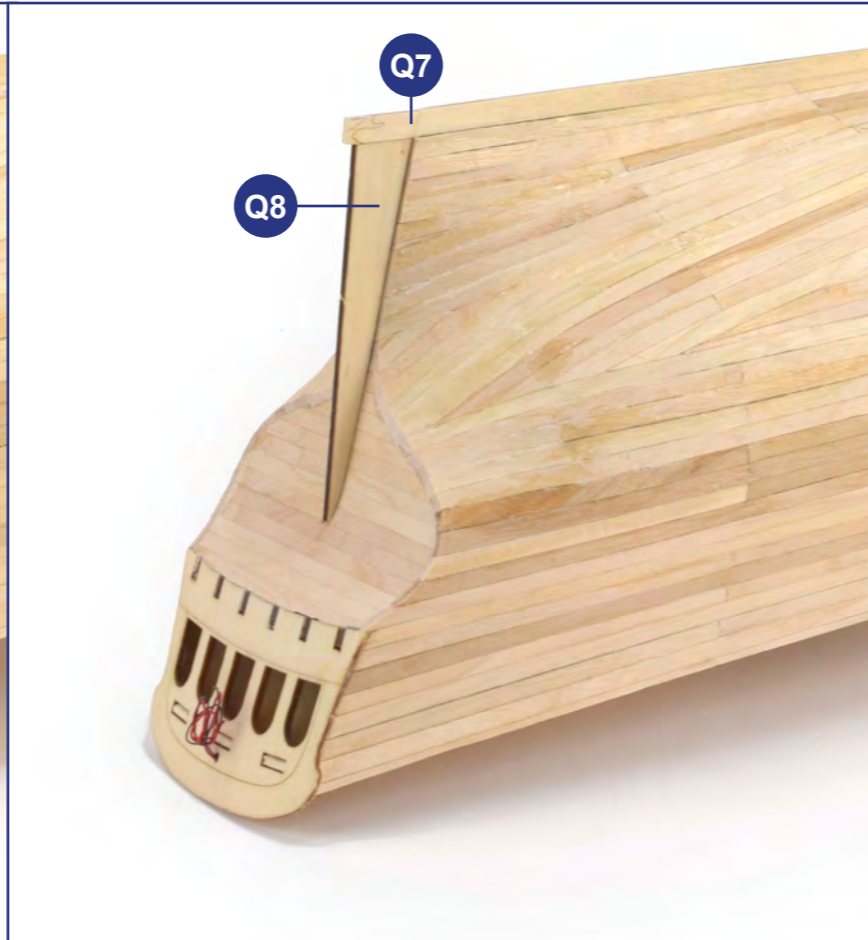

08



09

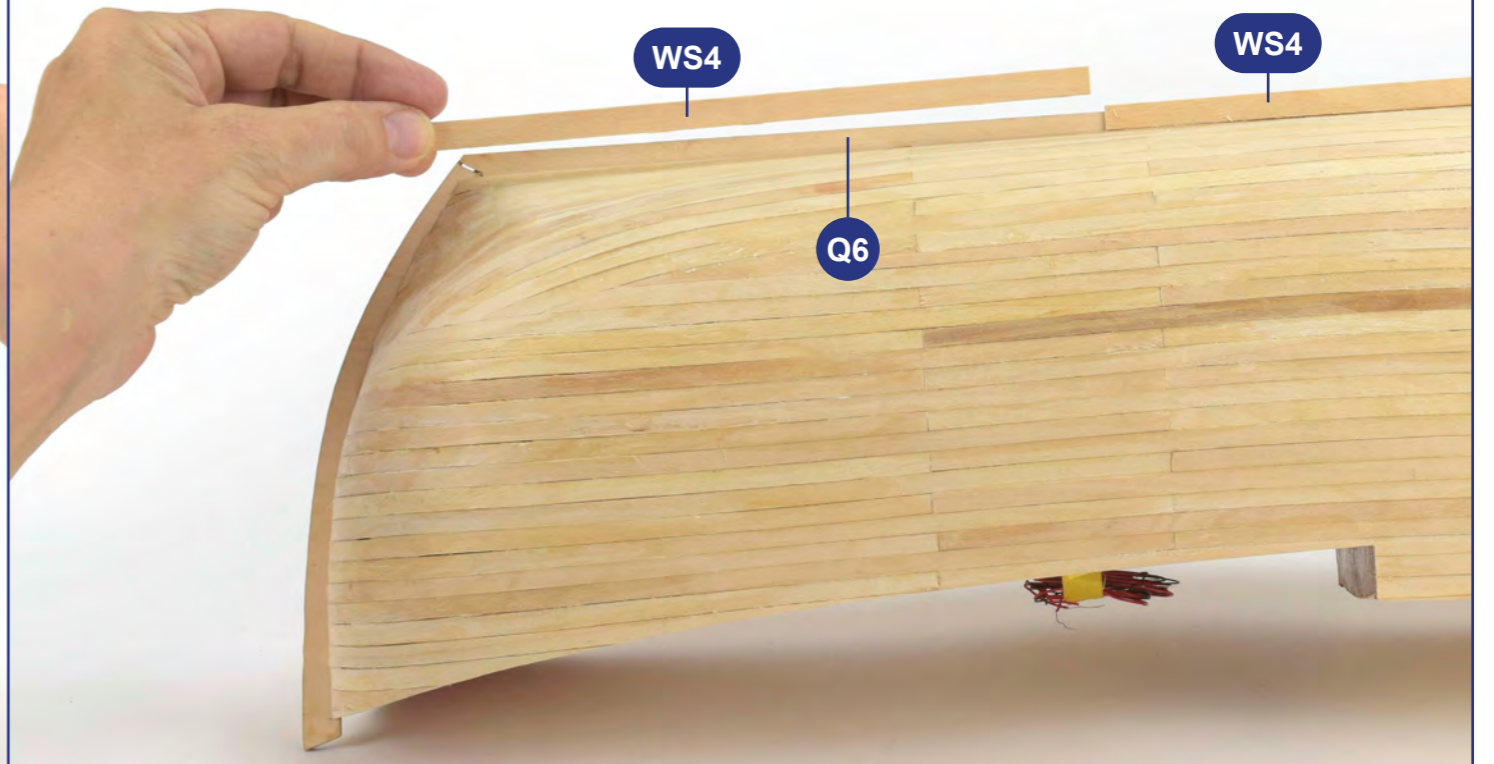
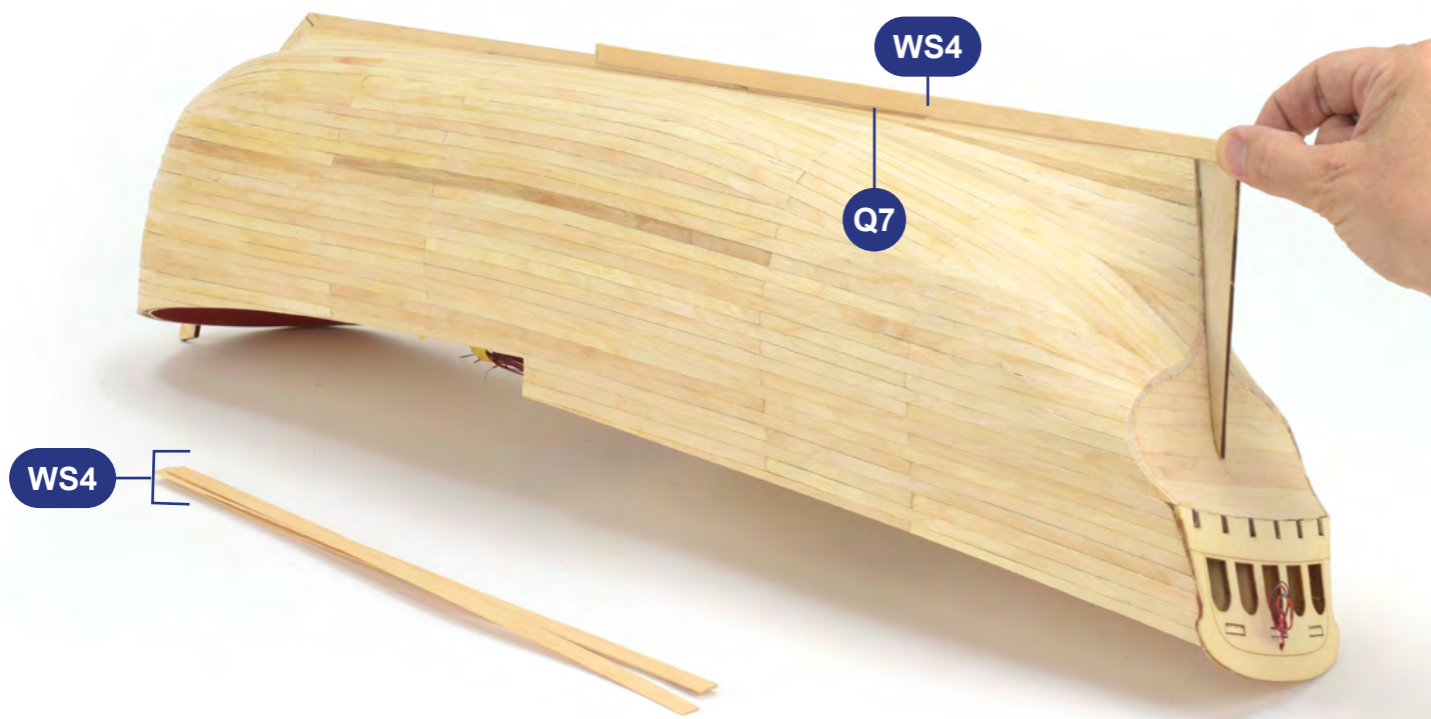

10

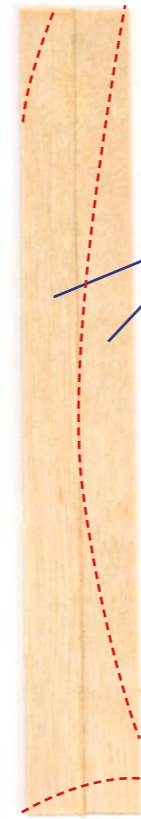
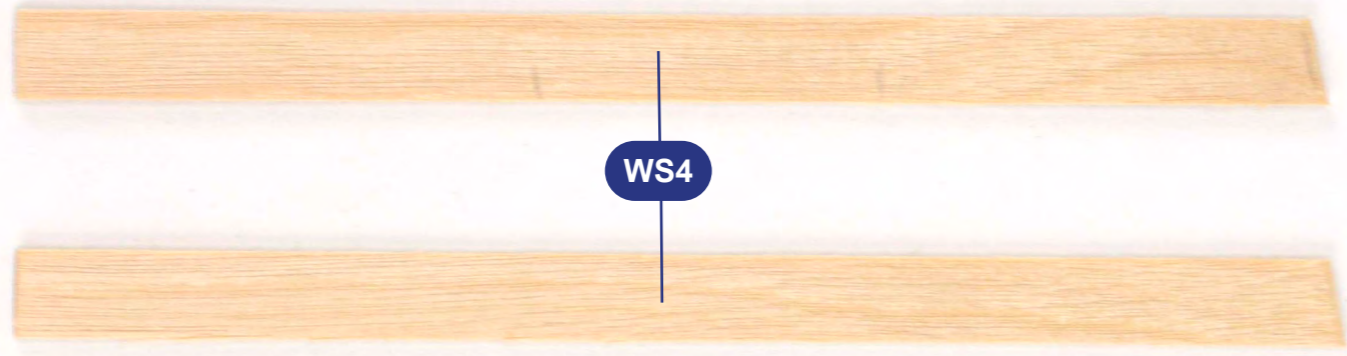

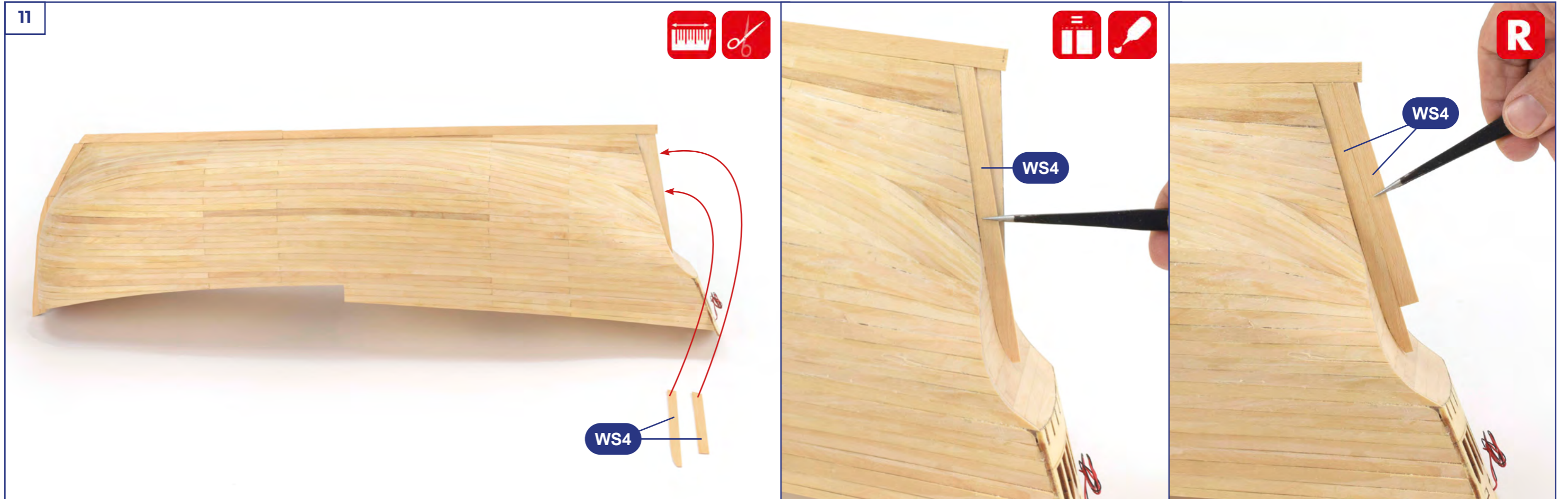

01

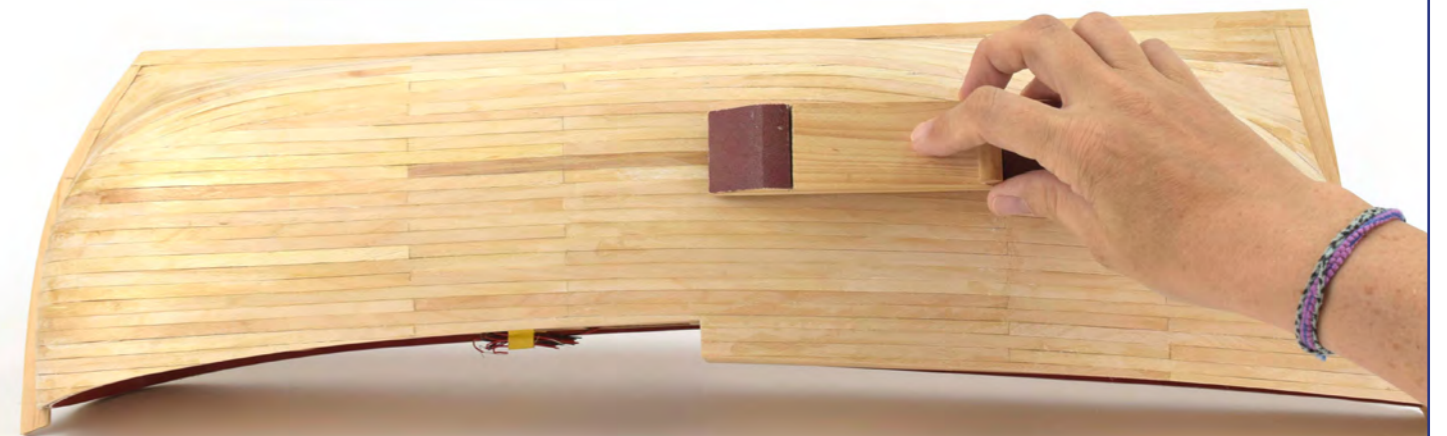

02



03

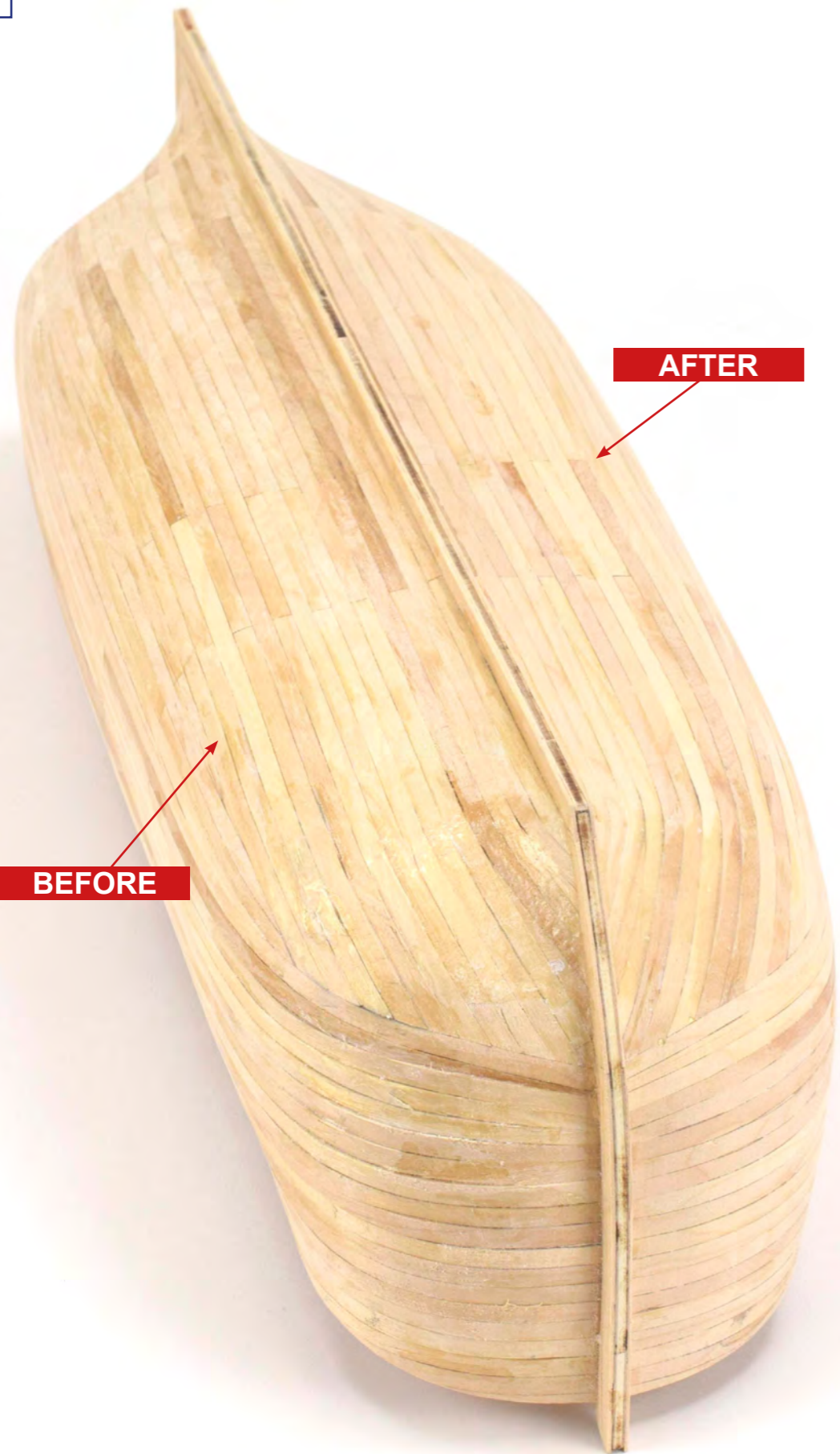

04



05



06



07



08



09

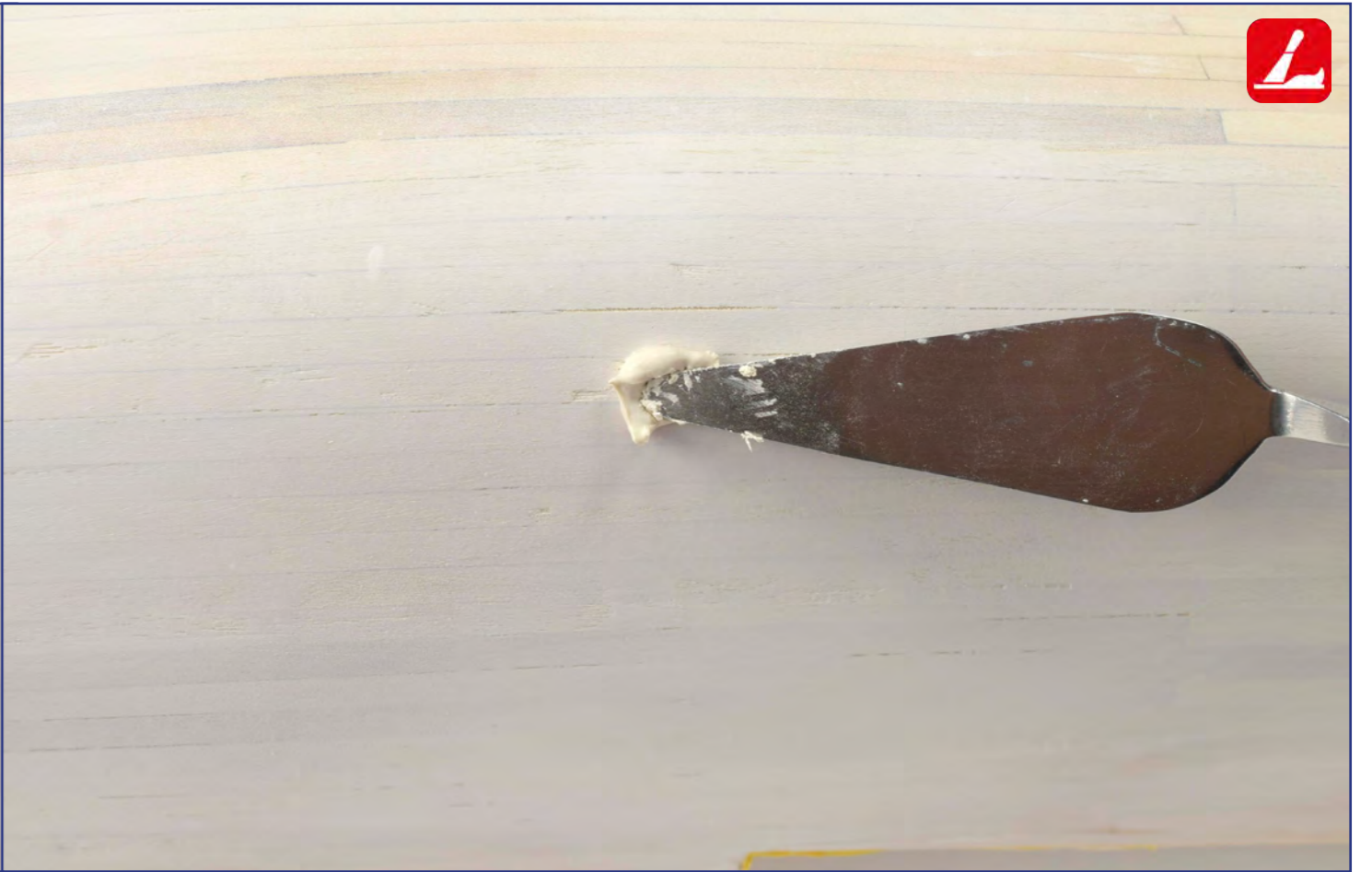
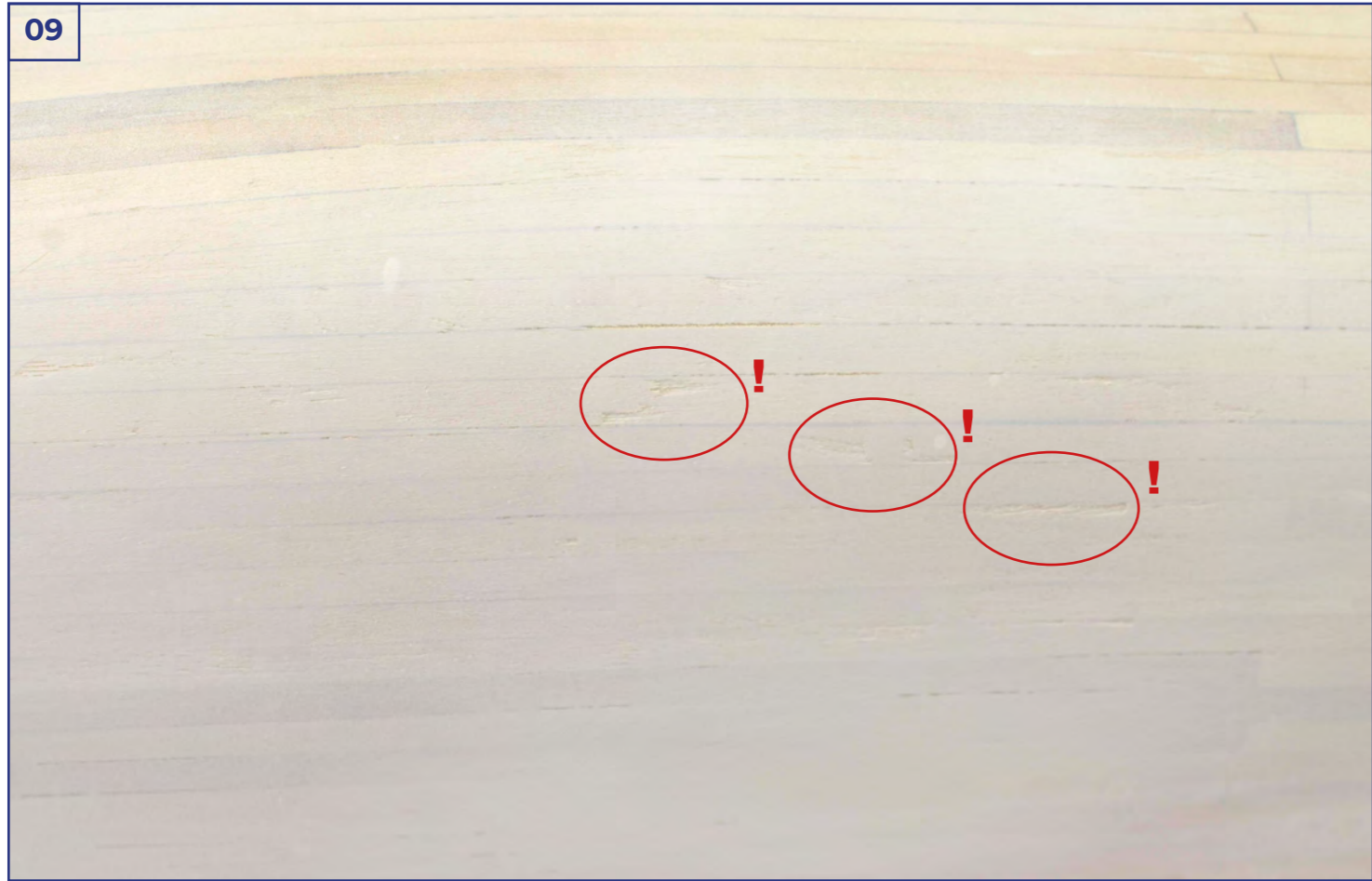

10

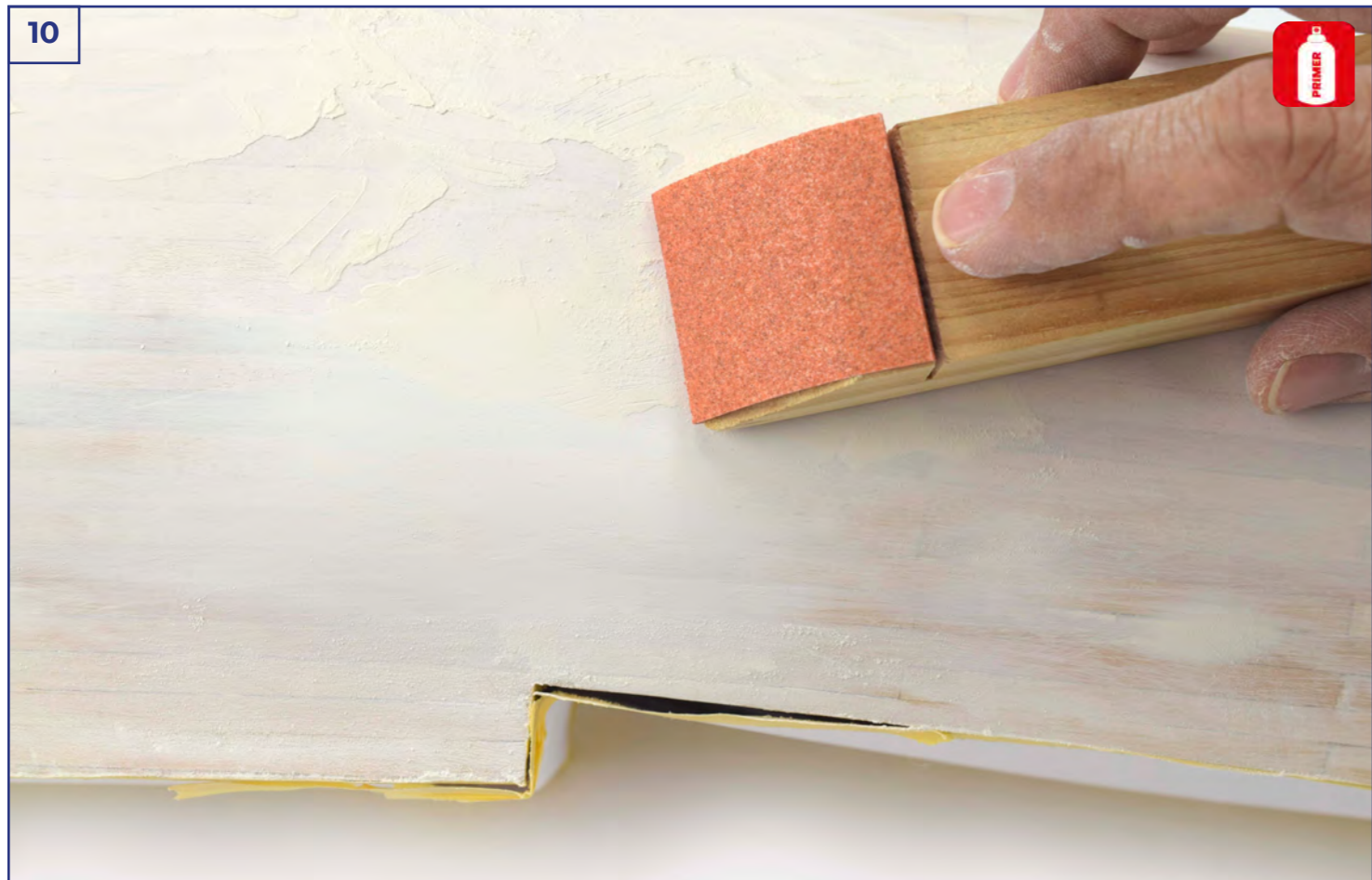

01



TEMPLATE 1L

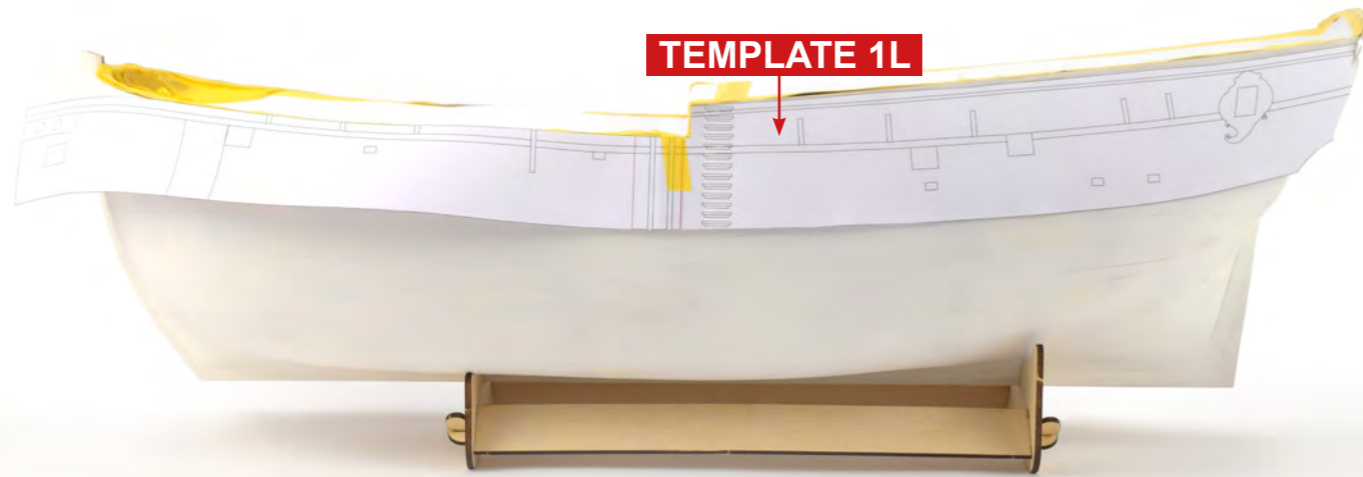

TEMPLATE 1L

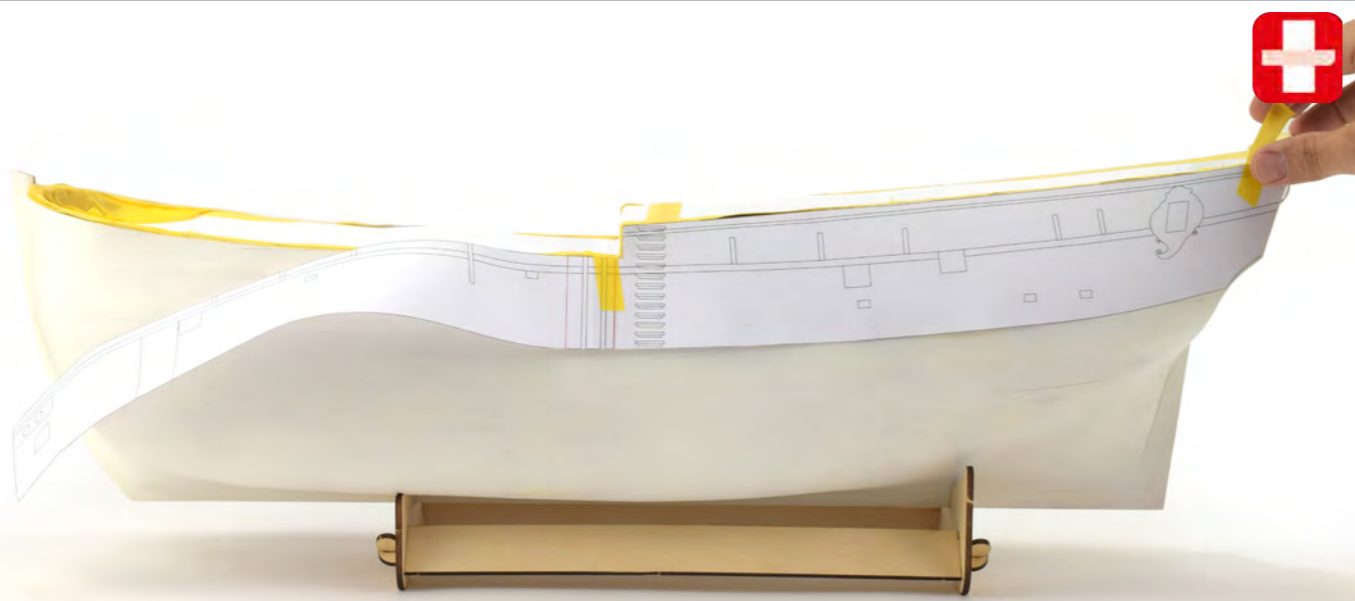

02

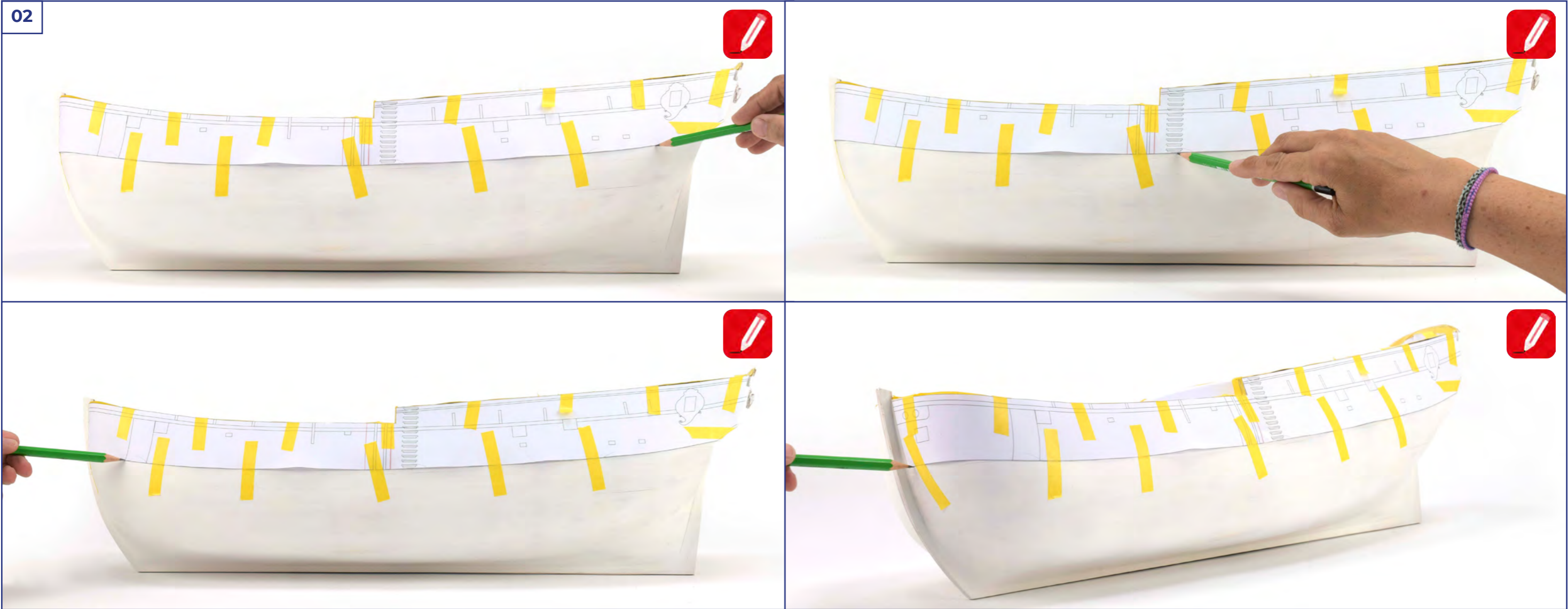

03

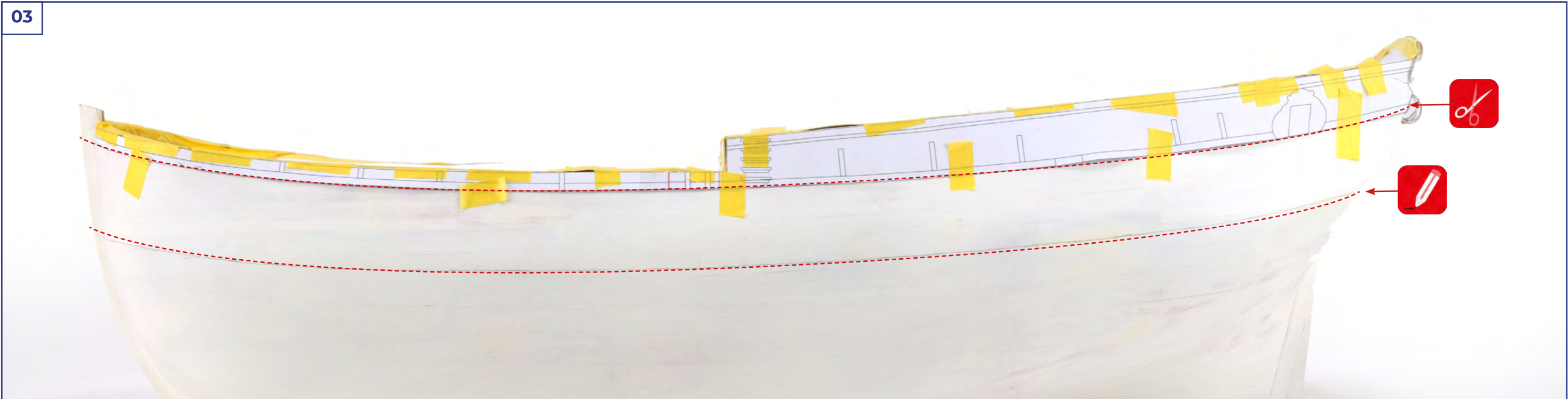

04



TEMPLATE 1L

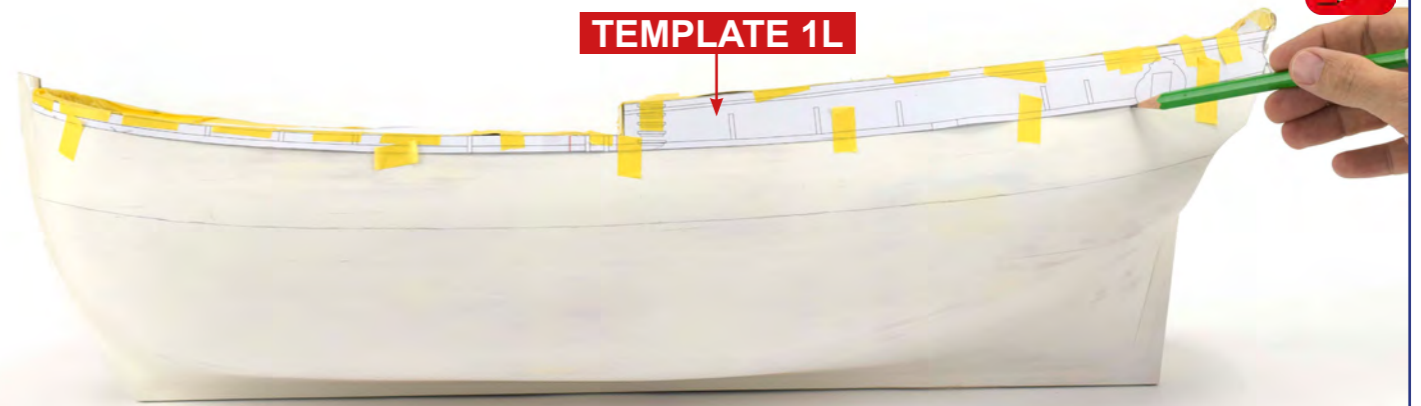

05

TEMPLATE 1L

DO NOT THROW AWAY
NO TIRAR
NE PAS JETER

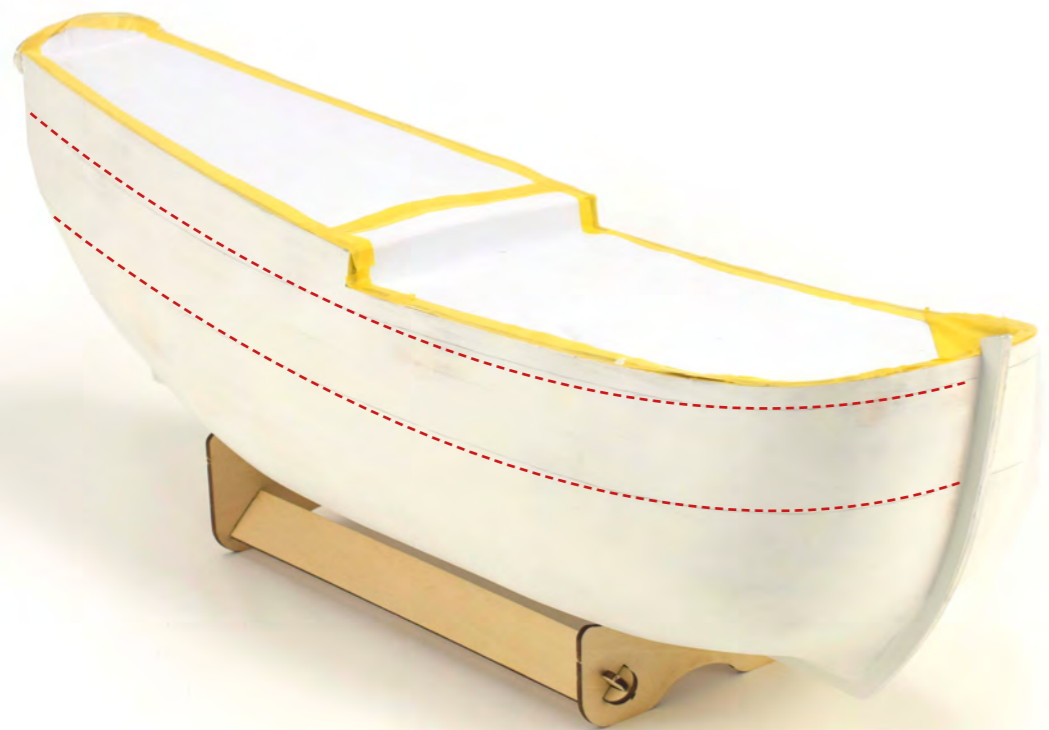
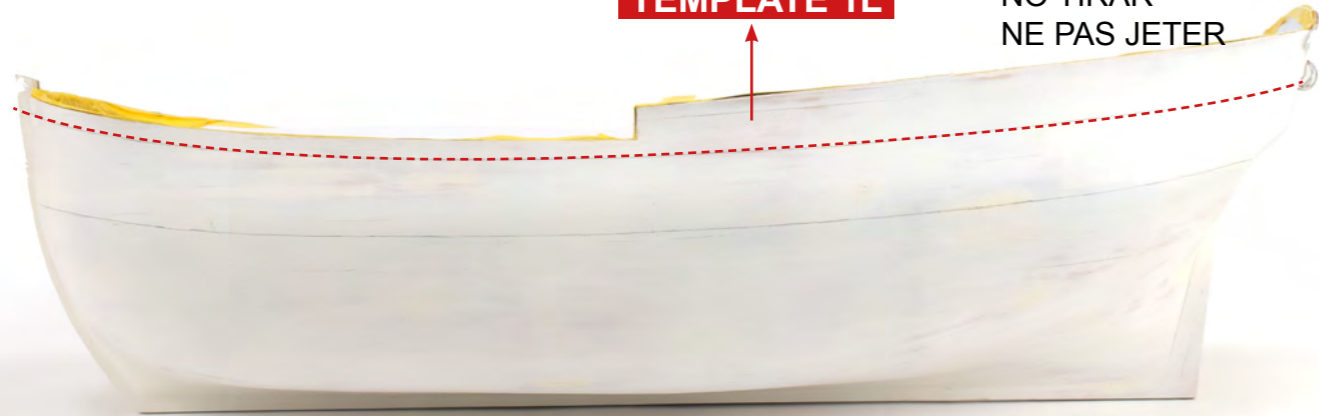

FRONT VIEW

06



1

07

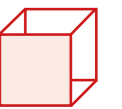
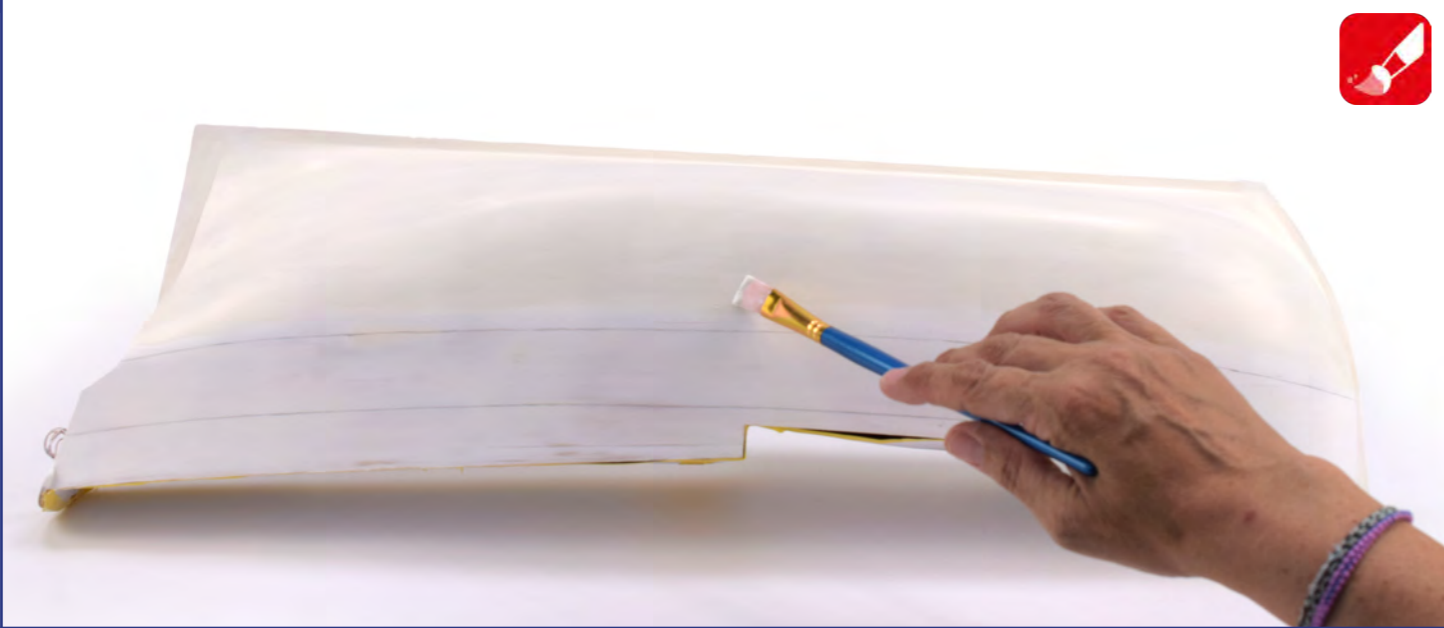

FRONT
VIEW

01

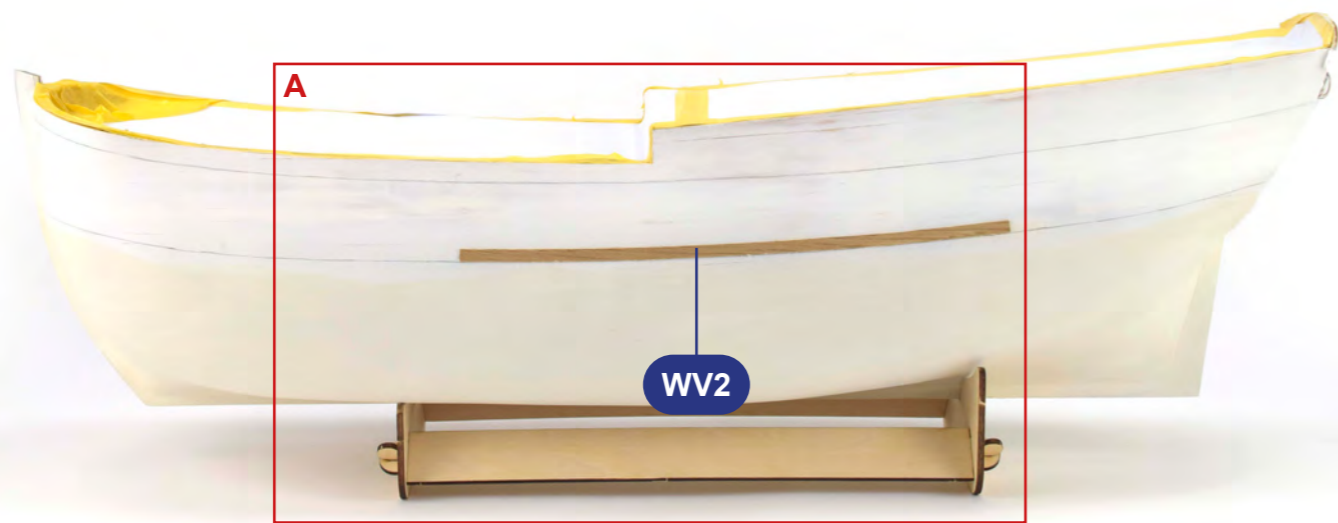
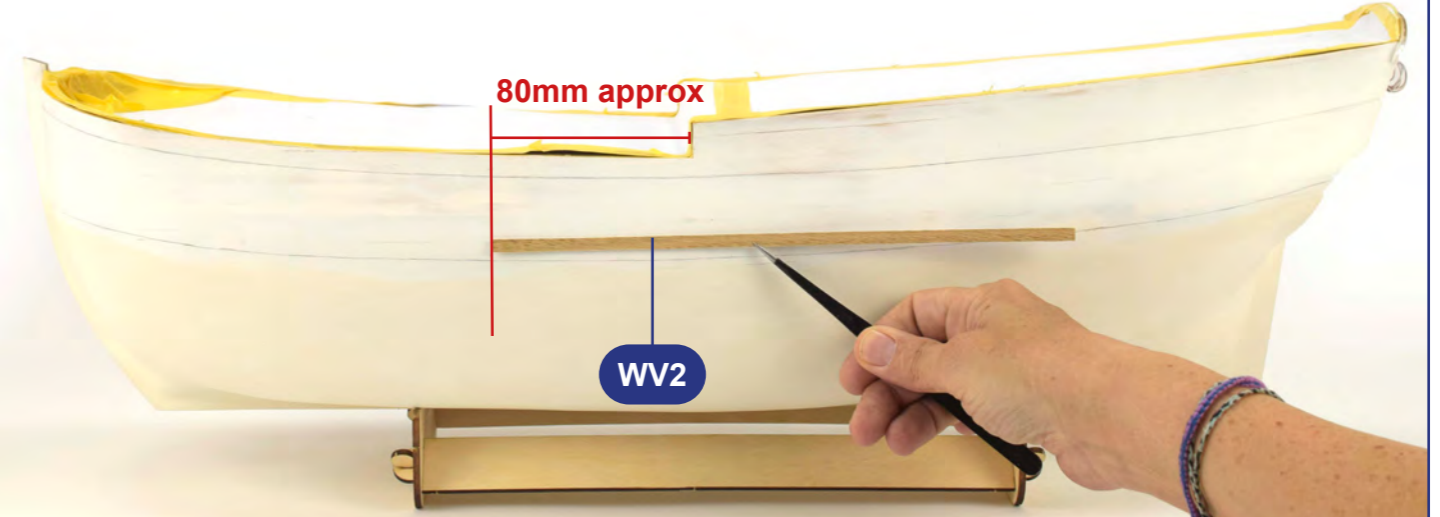

02

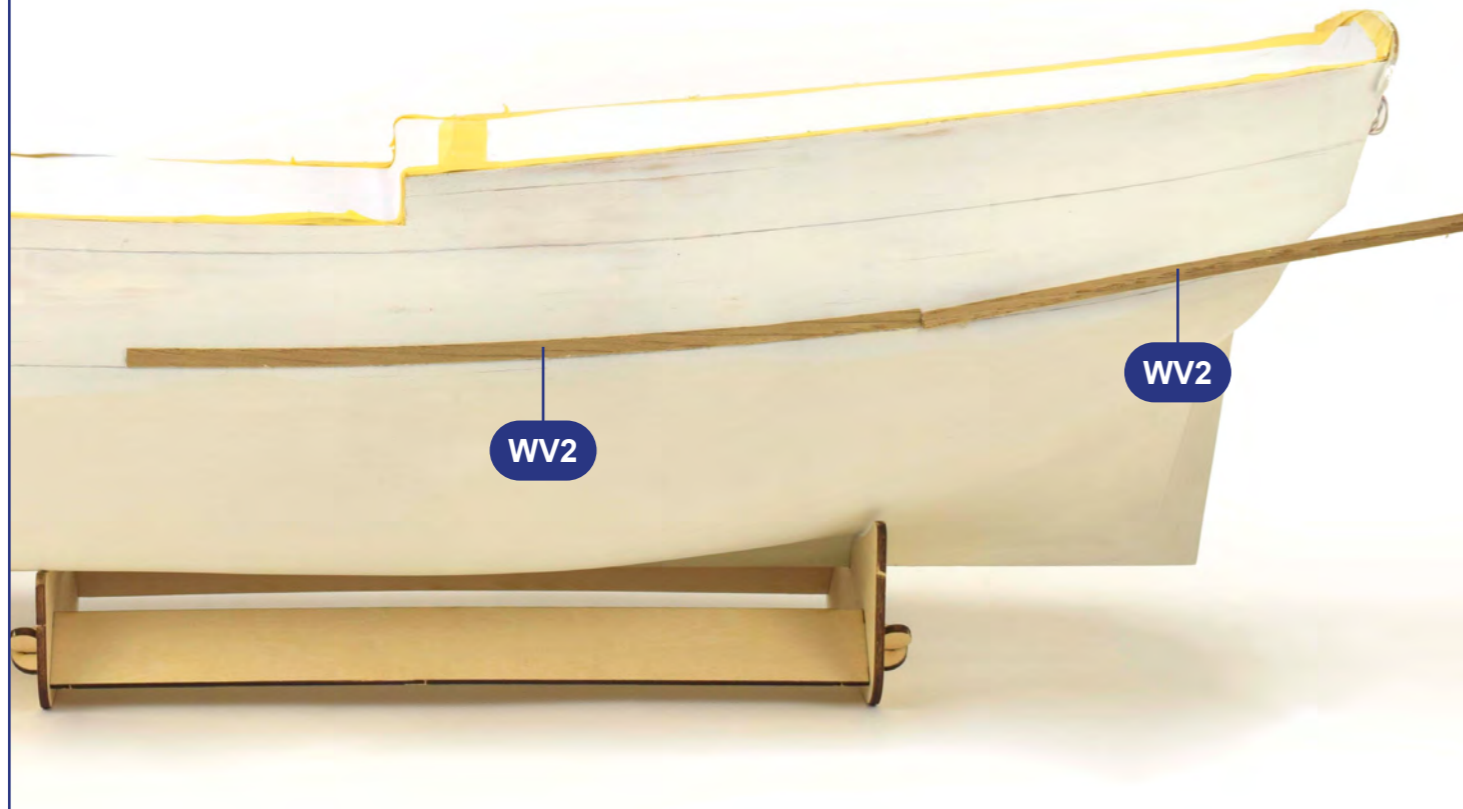

03

R



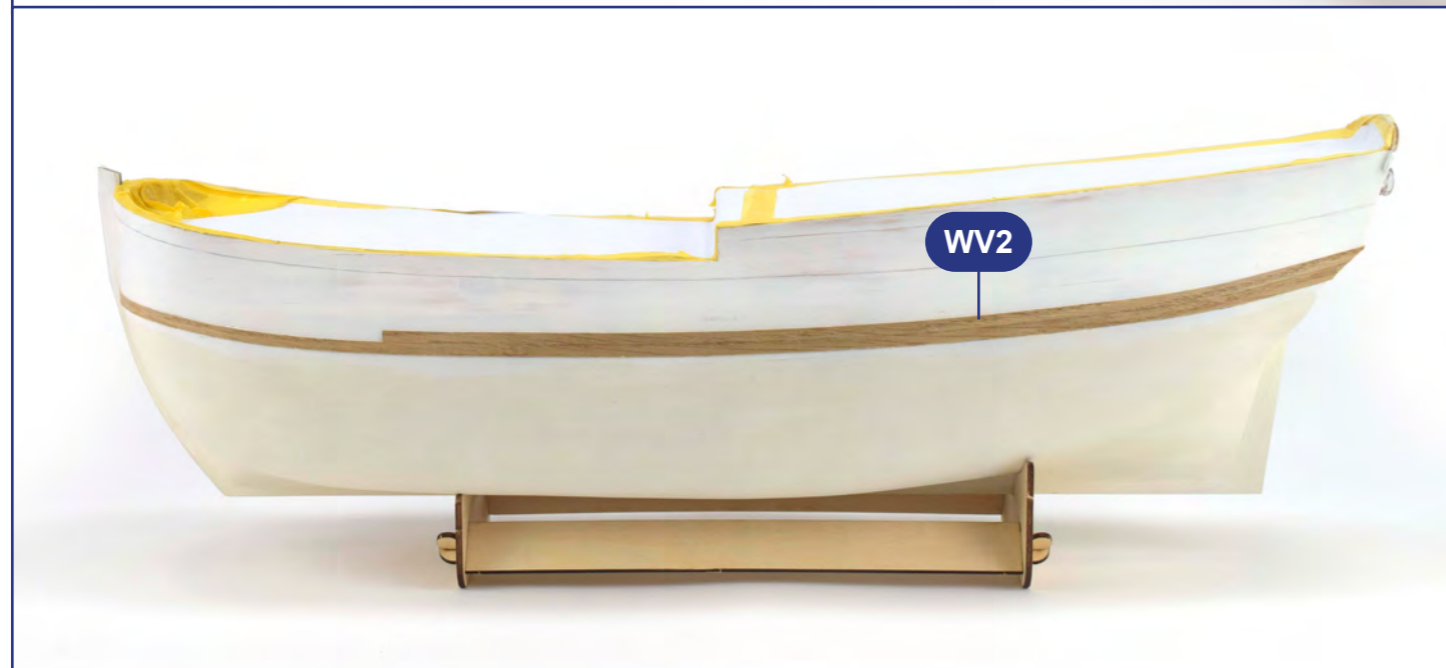
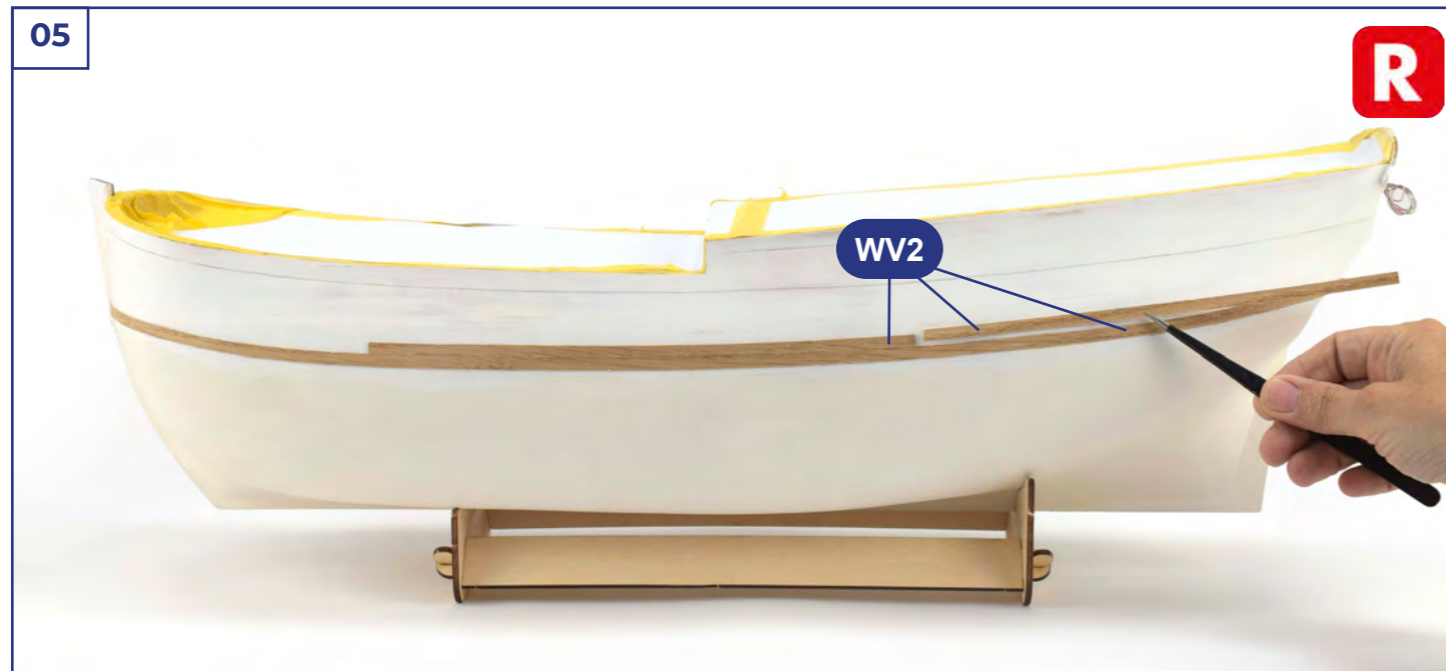
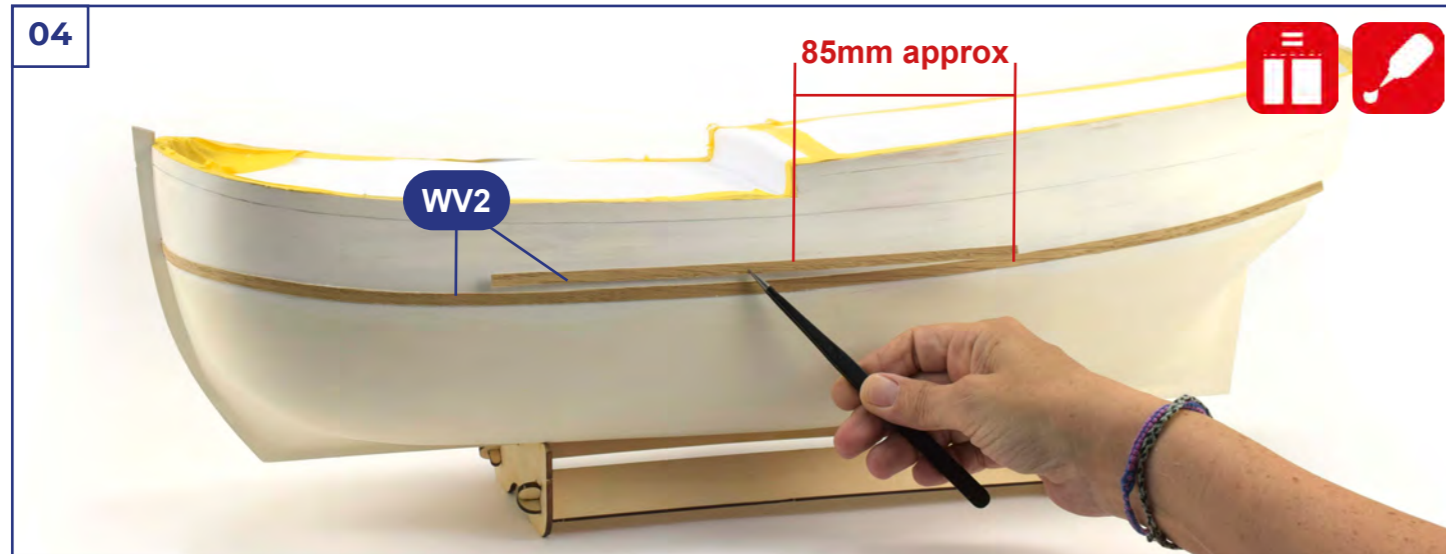

07

R



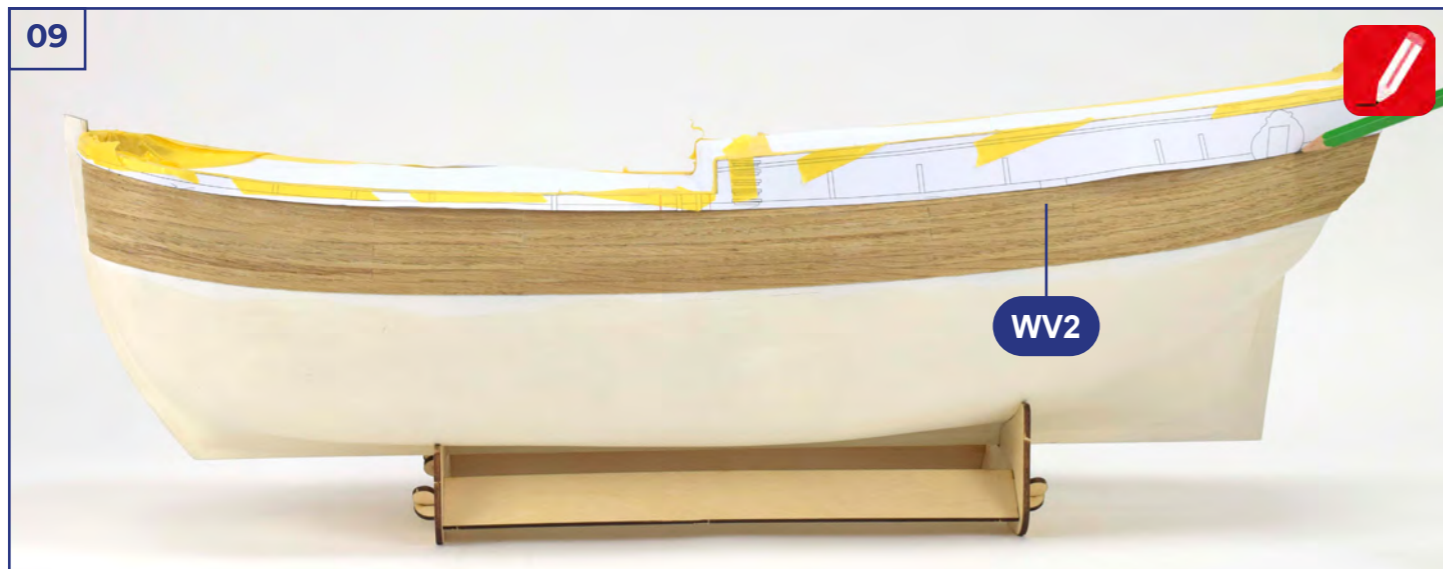
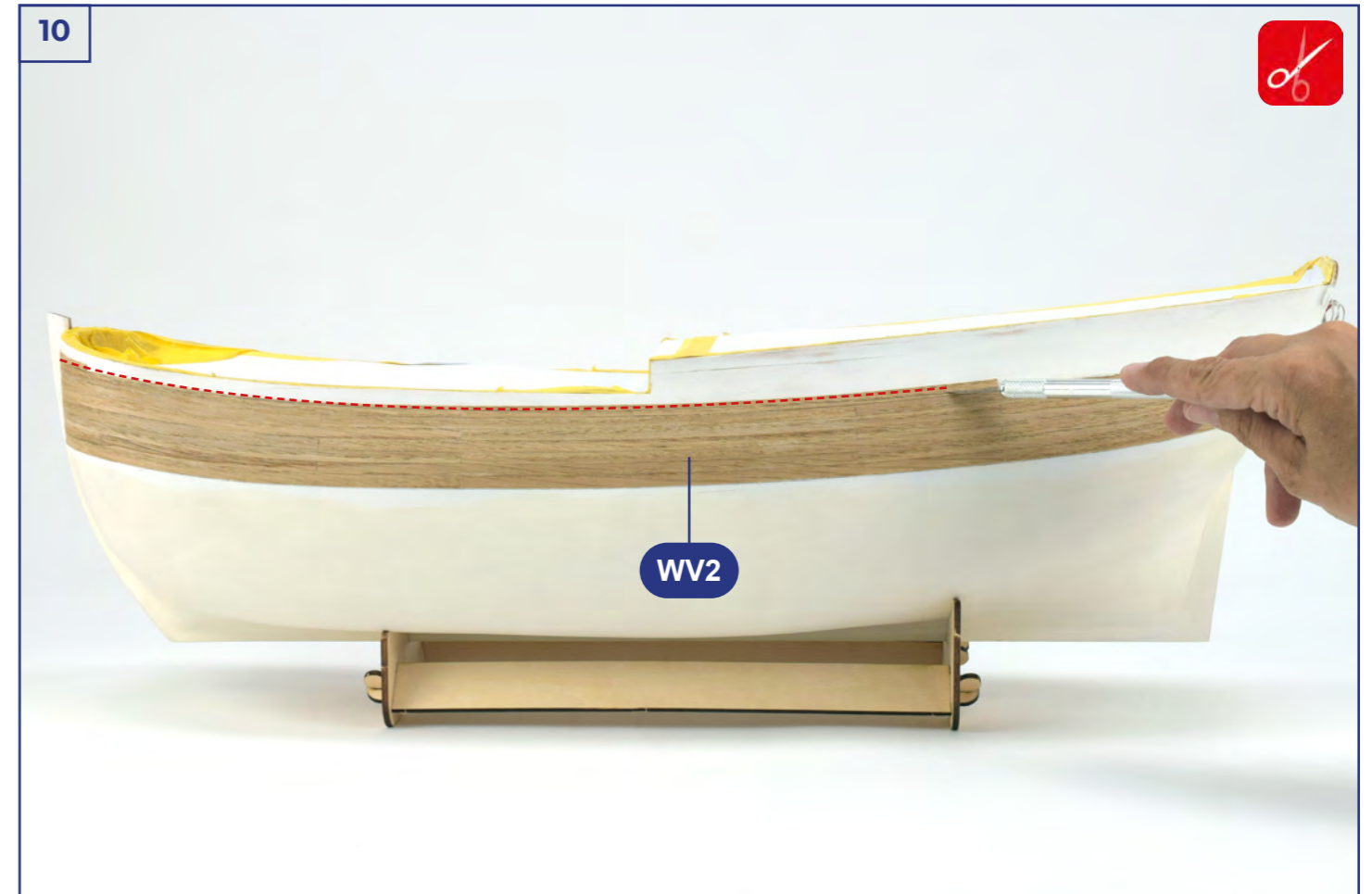
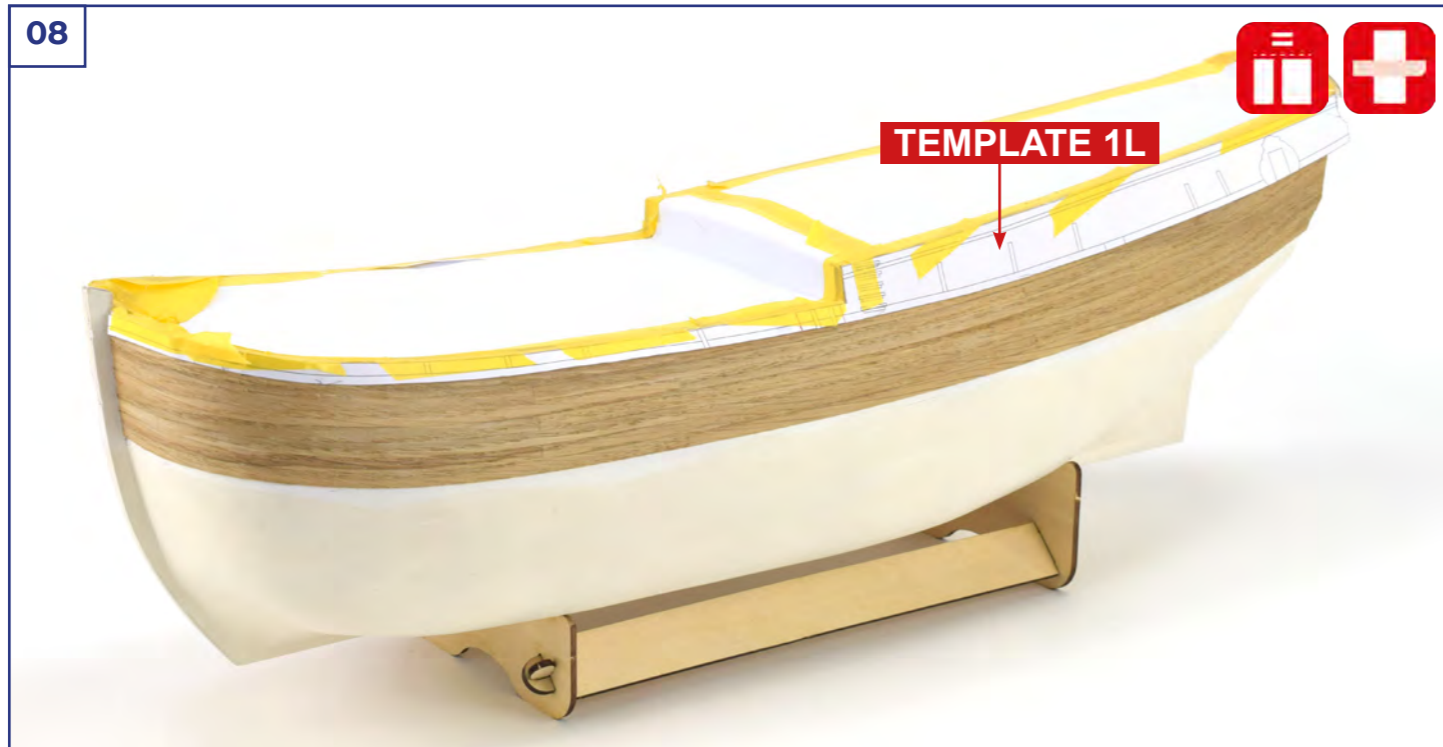

11

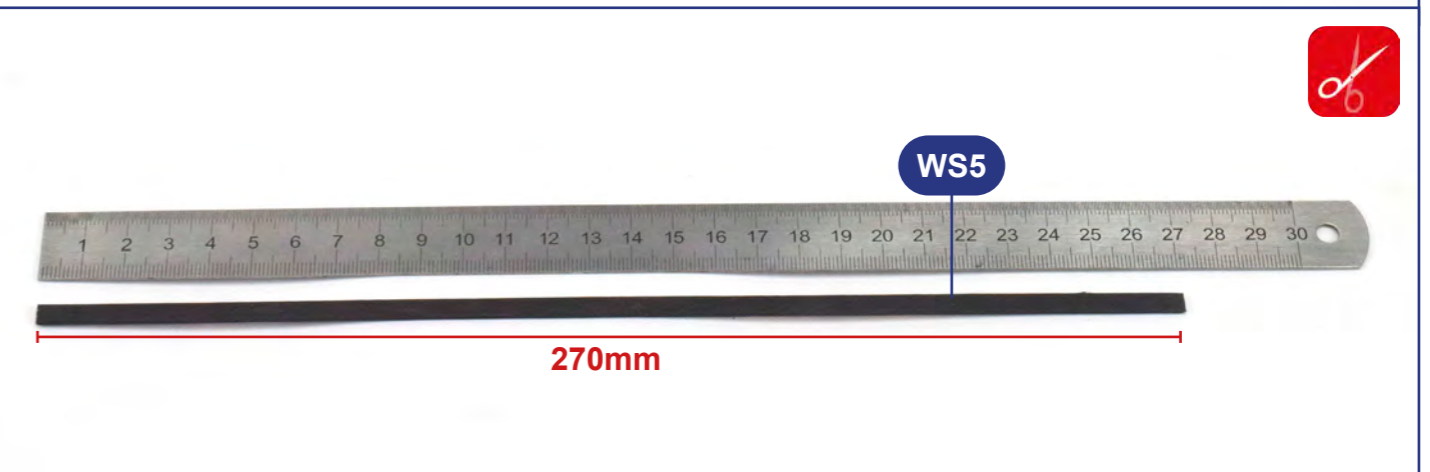
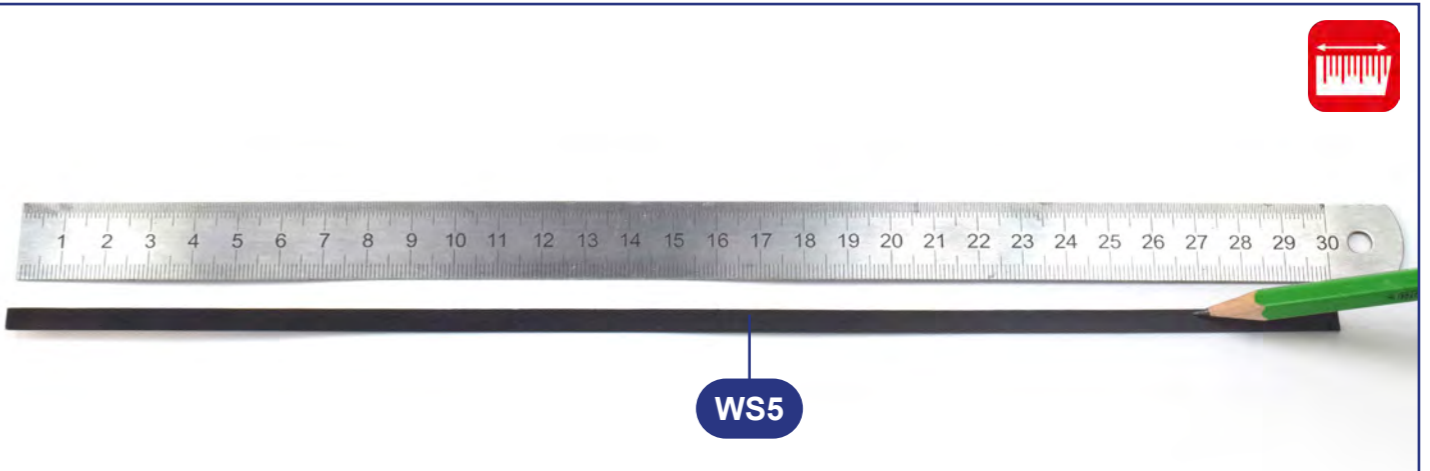
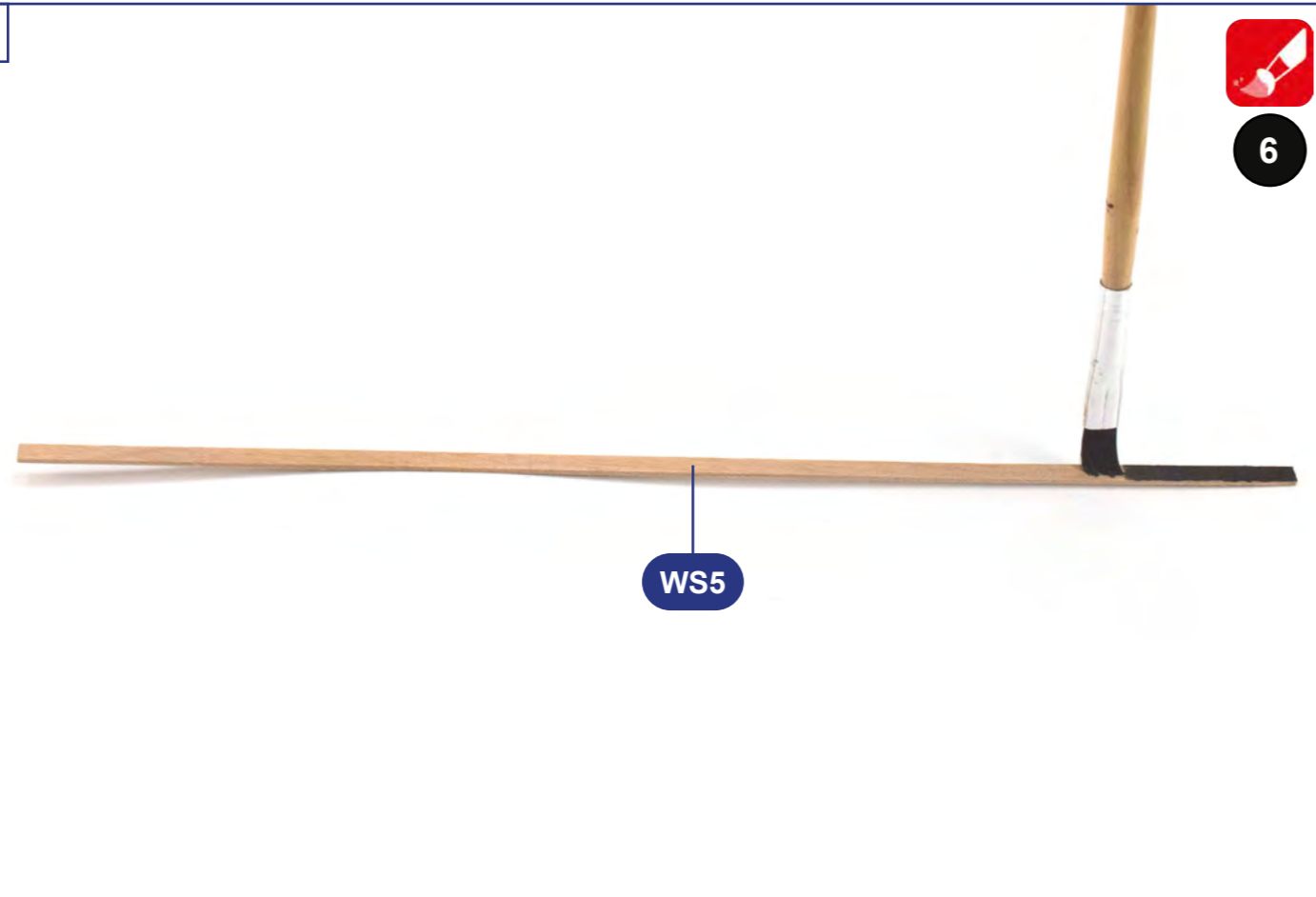

12

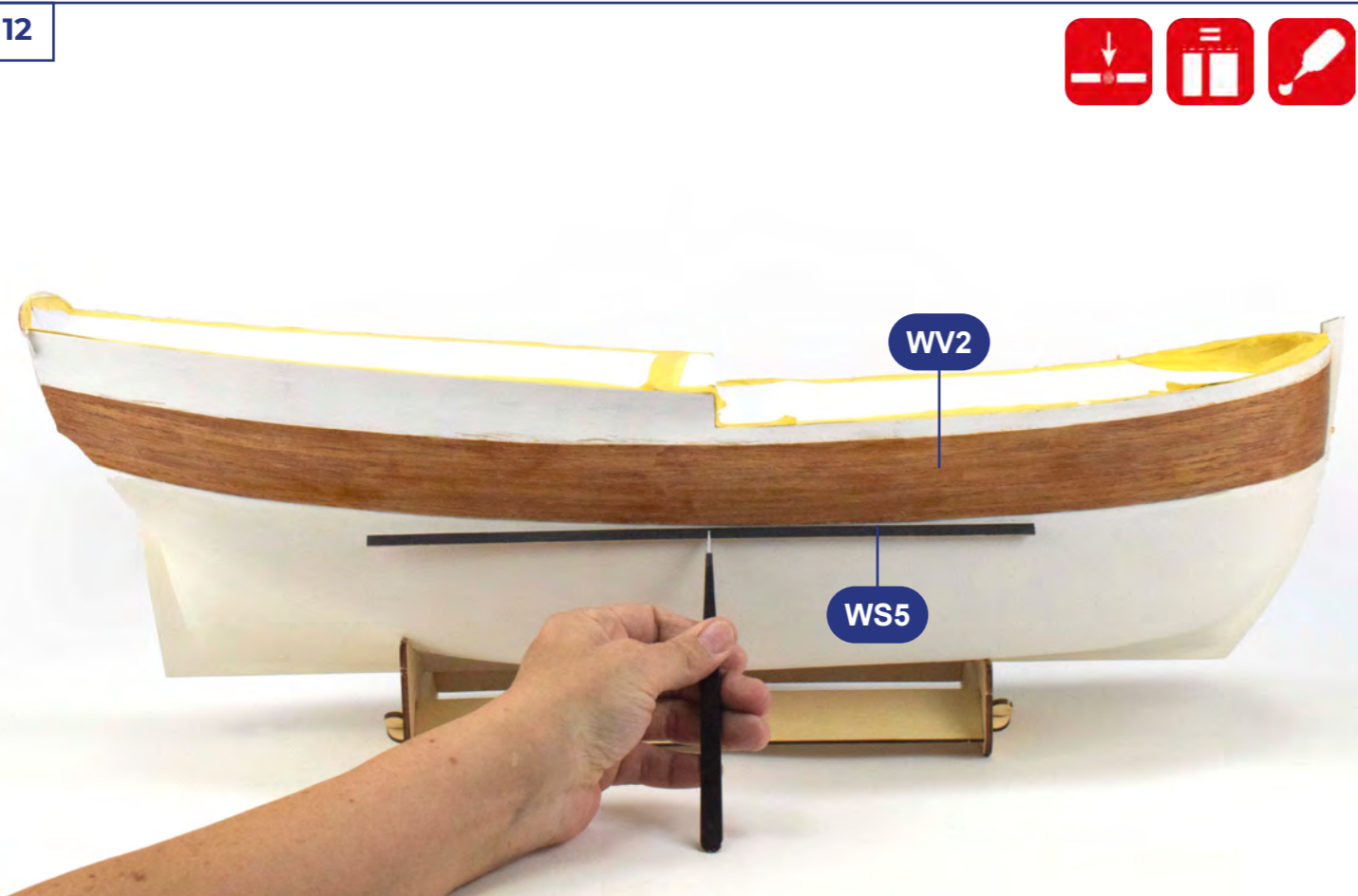

13



14

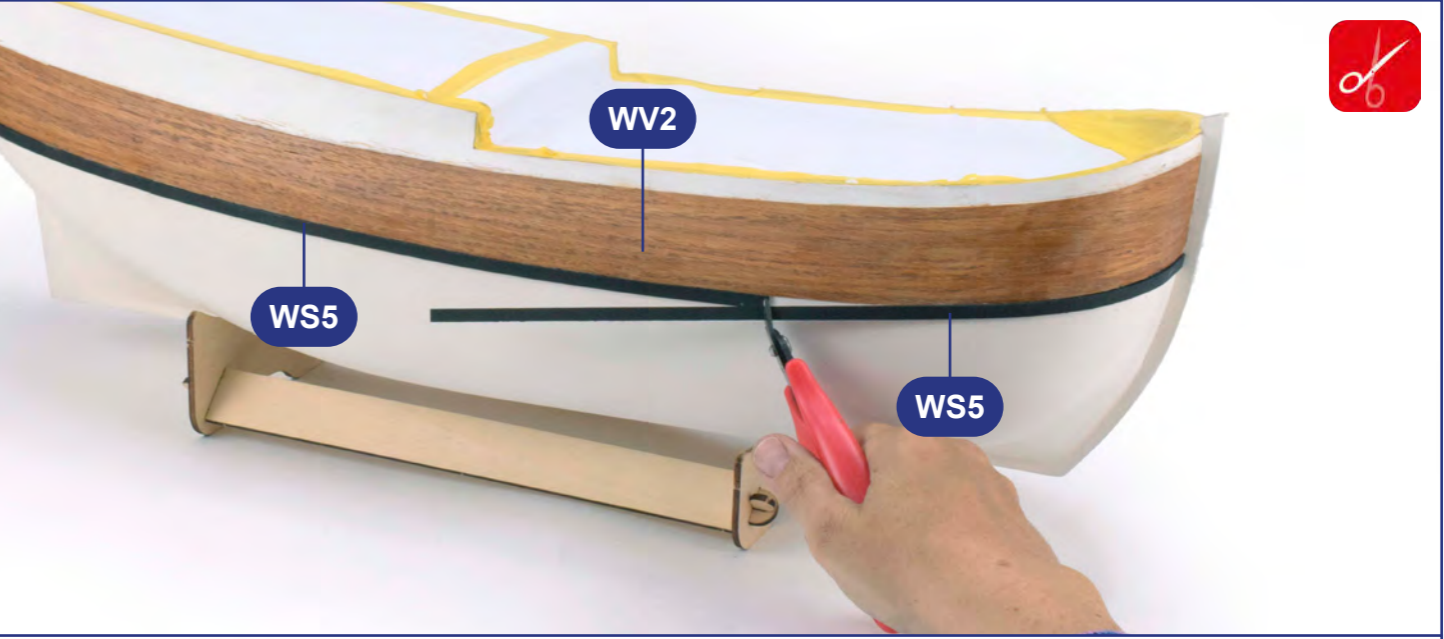
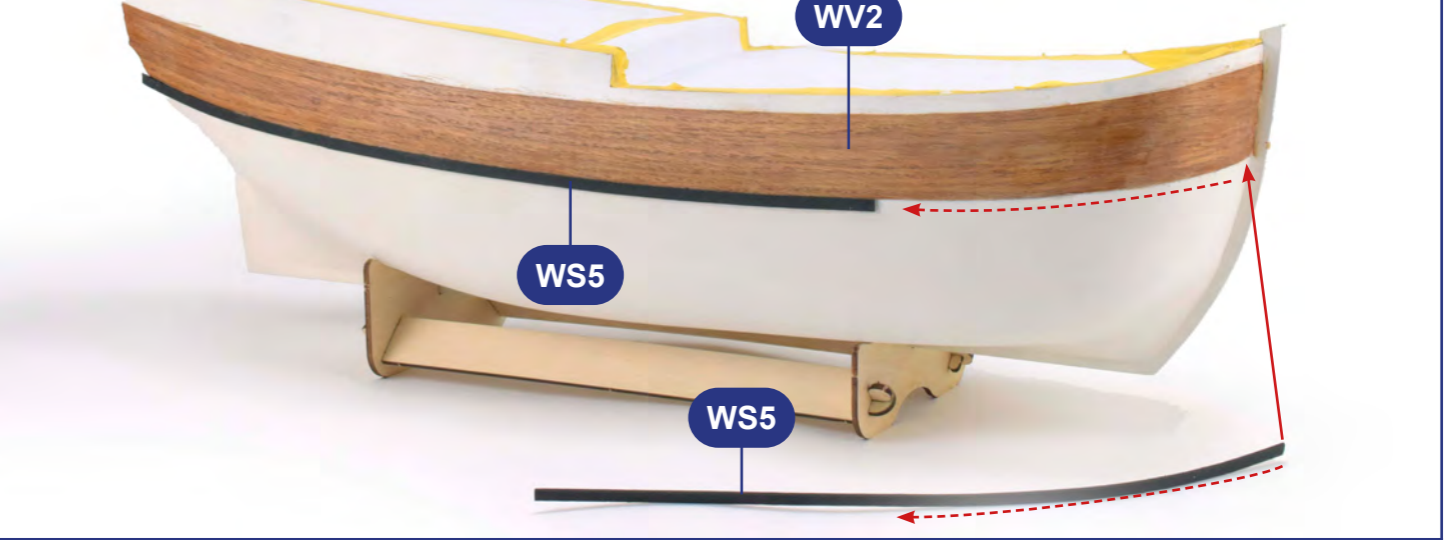

15

R



RIGHT VIEW

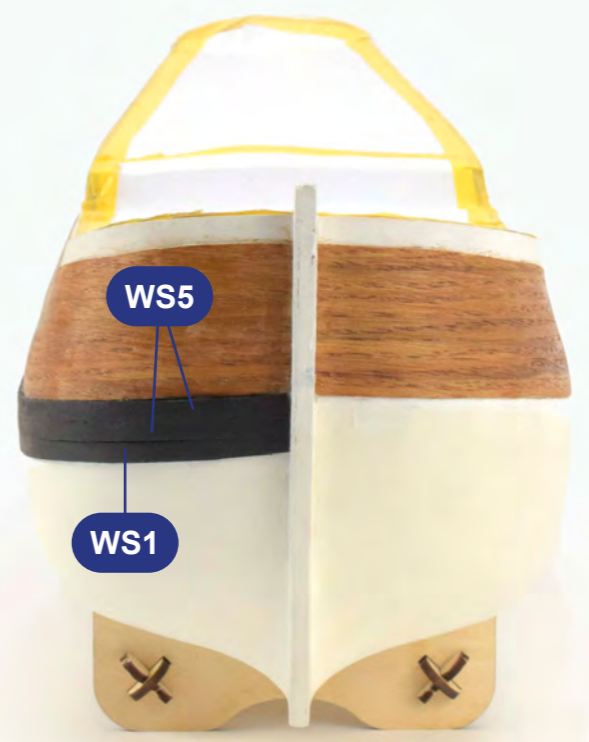

FRONT VIEW



16

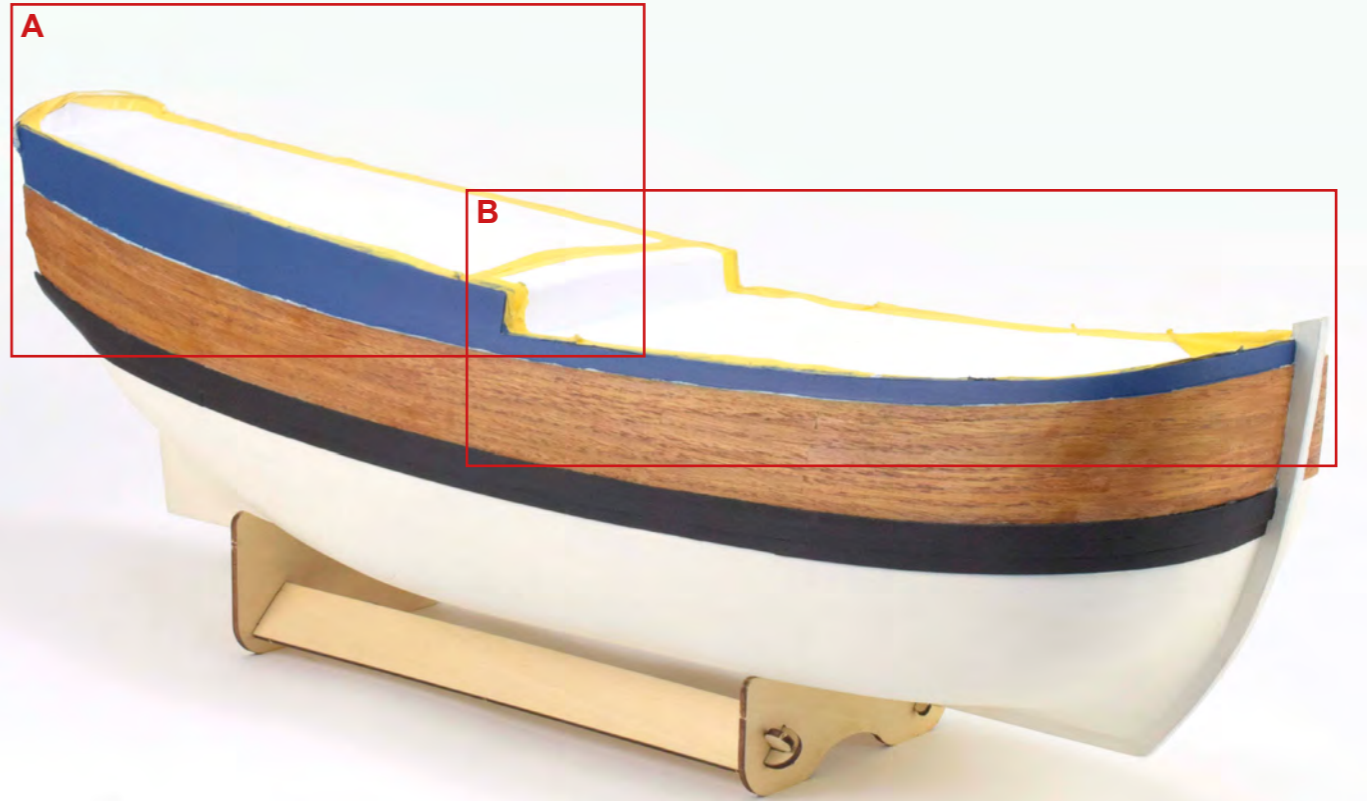

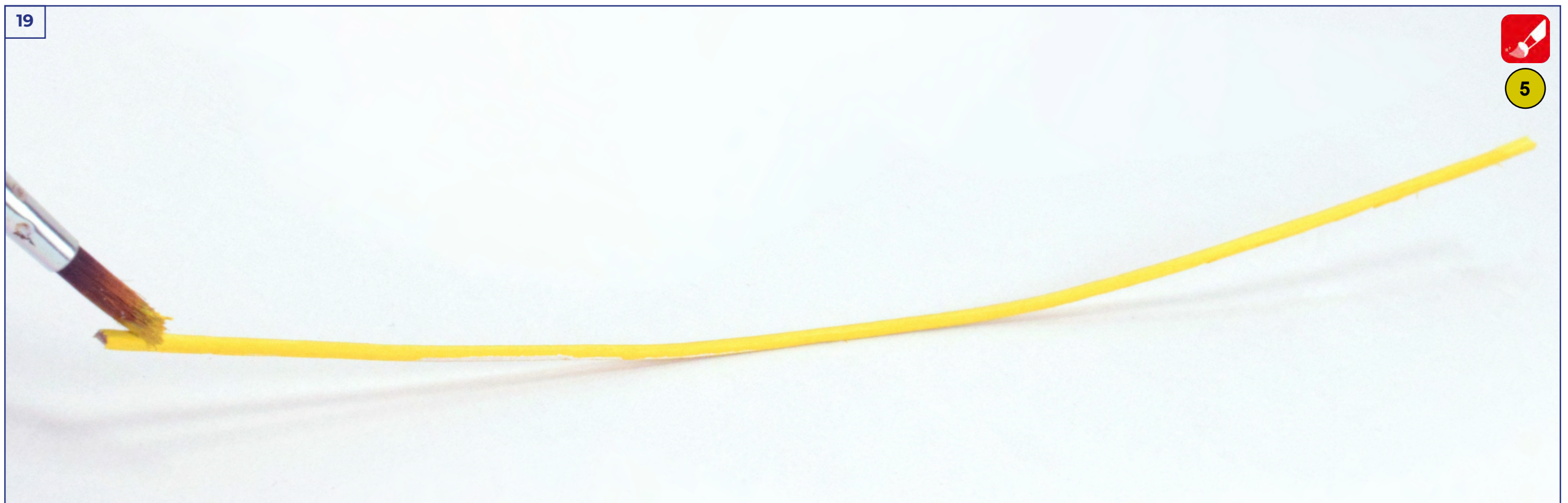
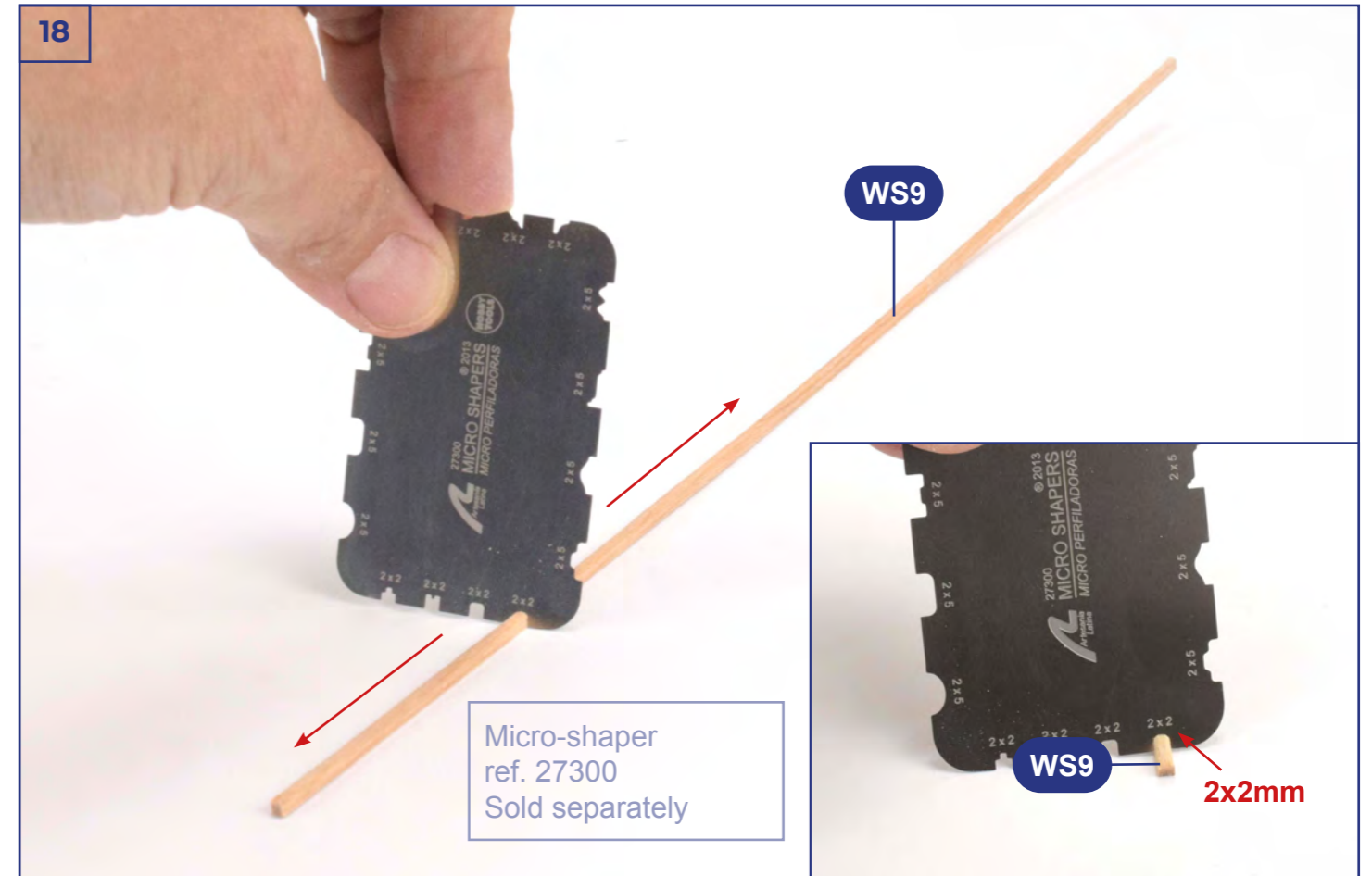
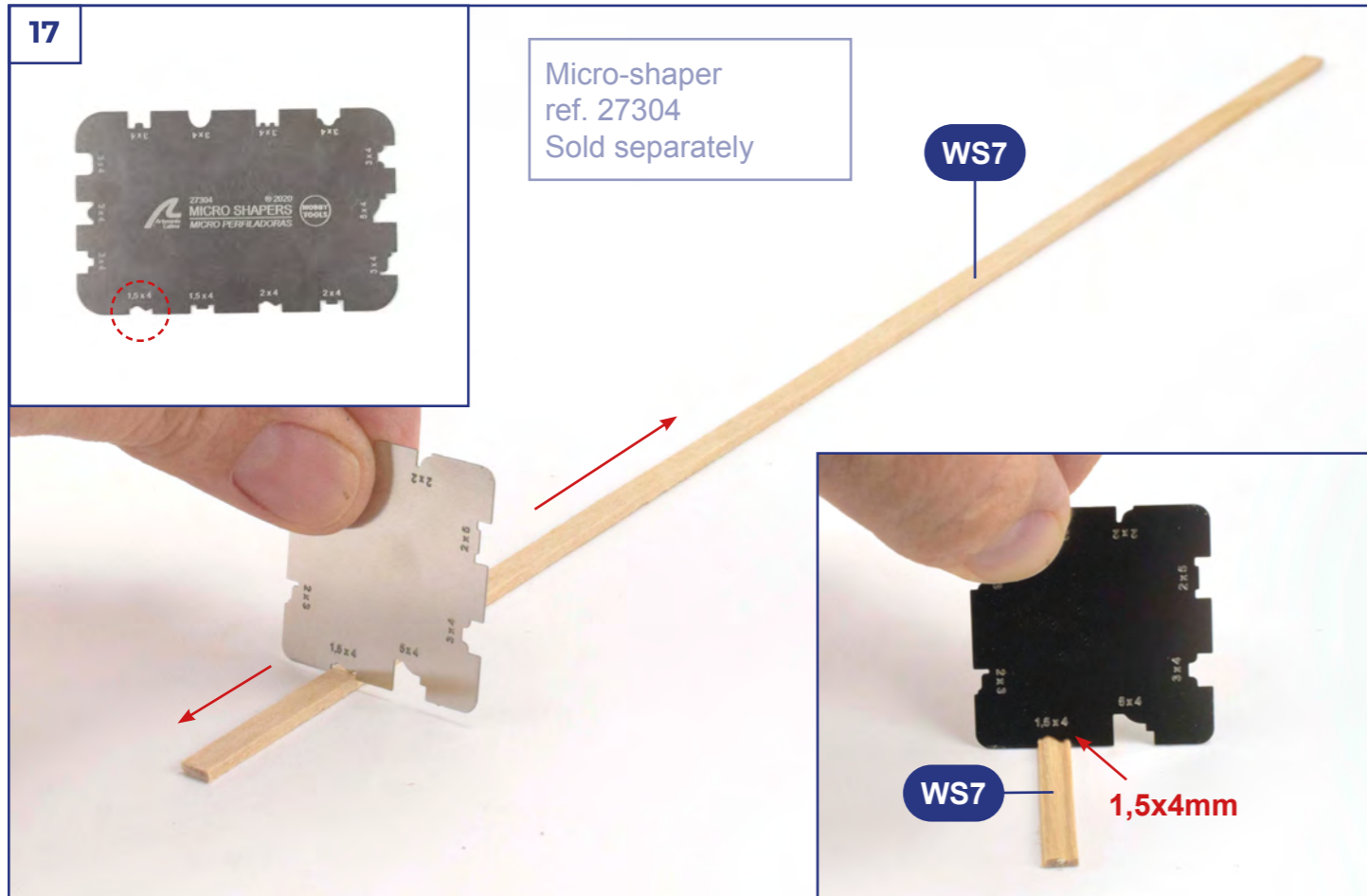

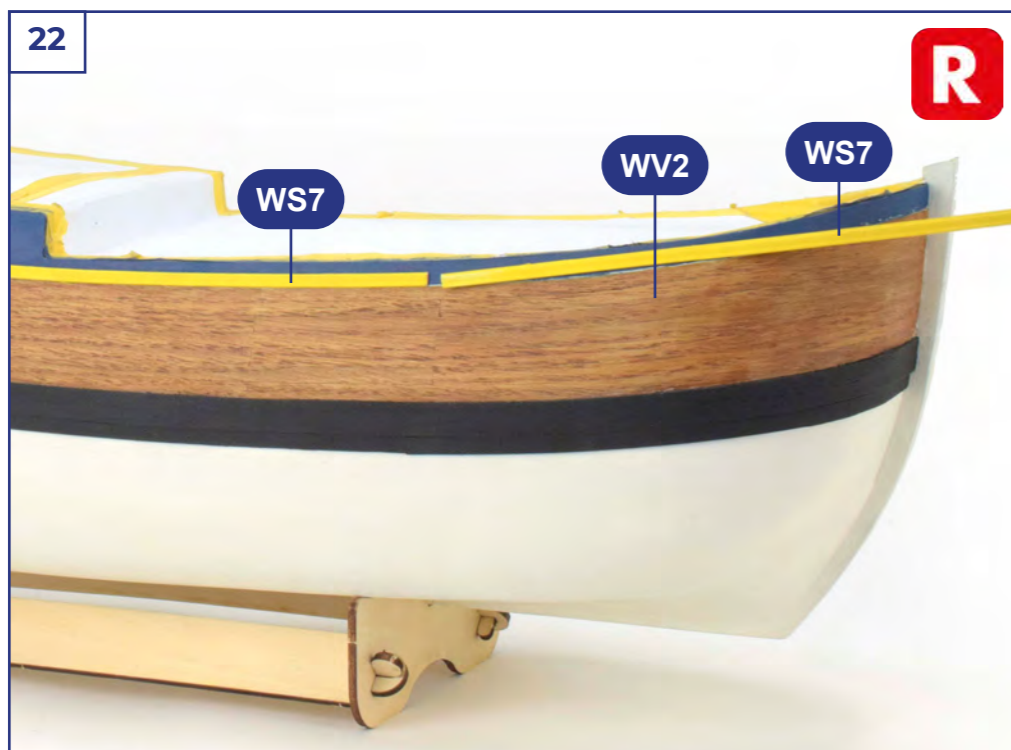
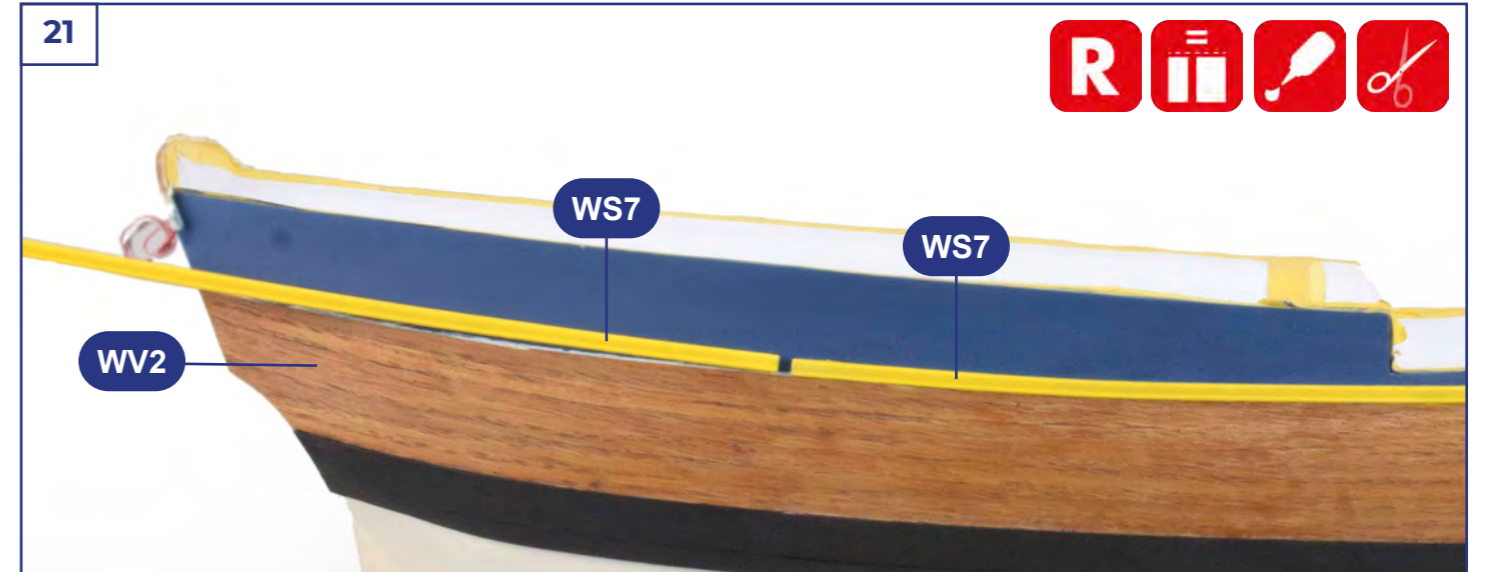
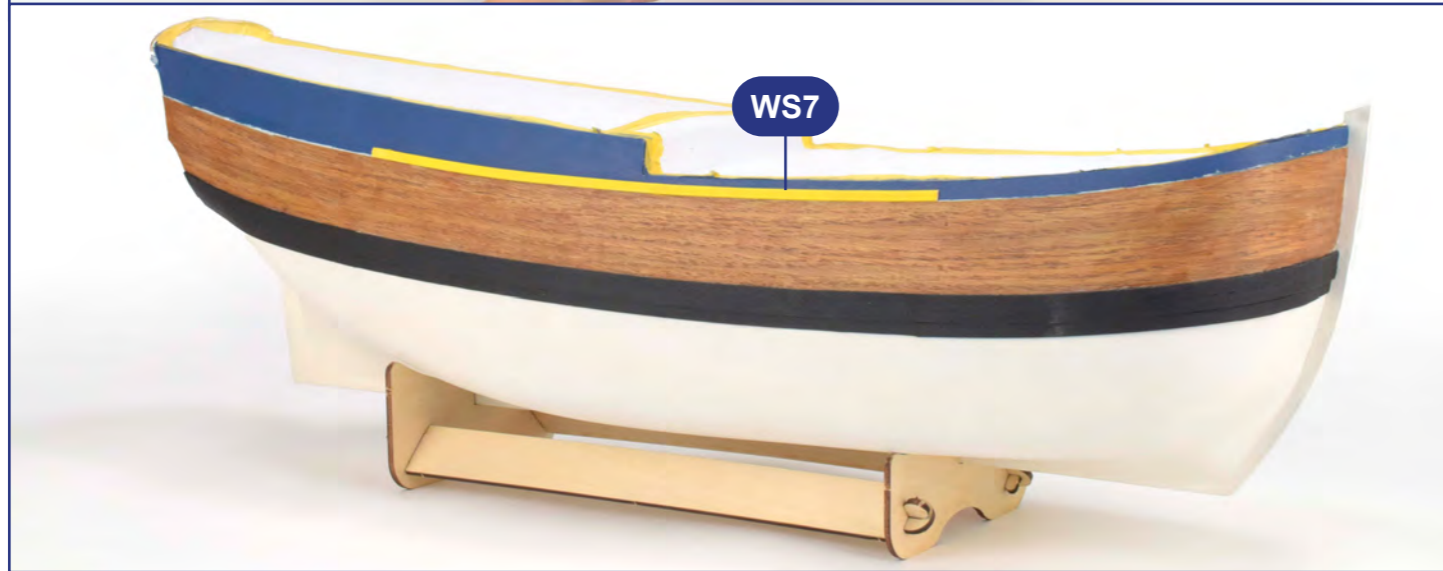
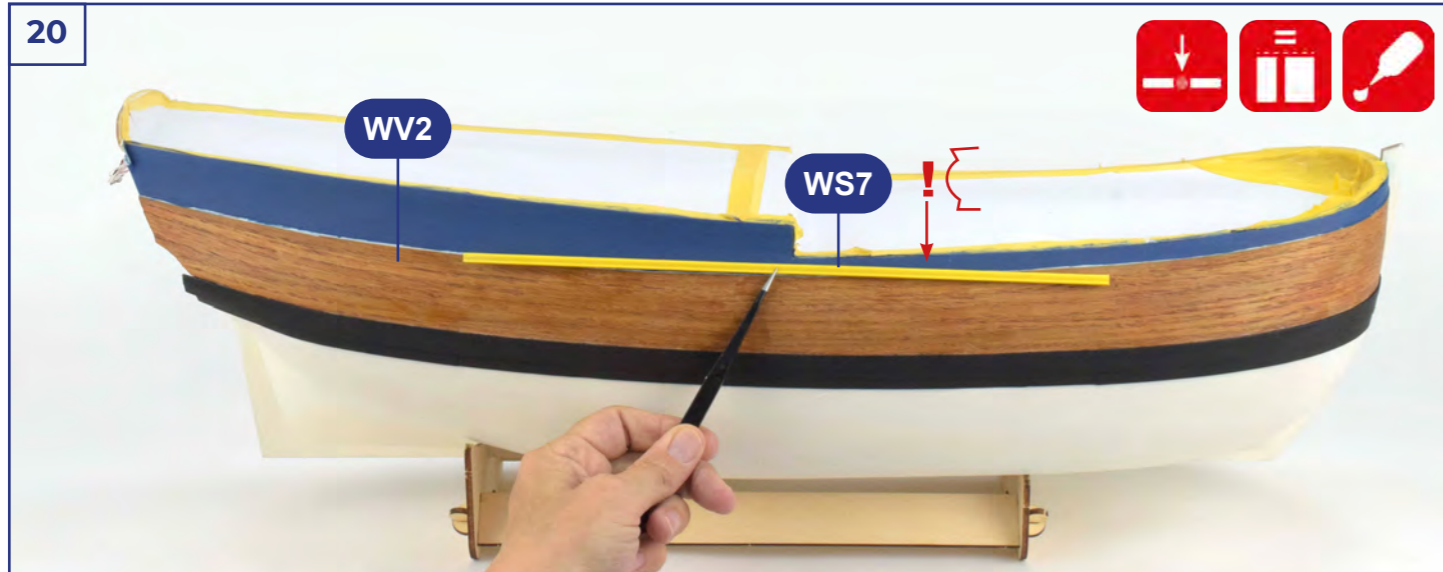

24

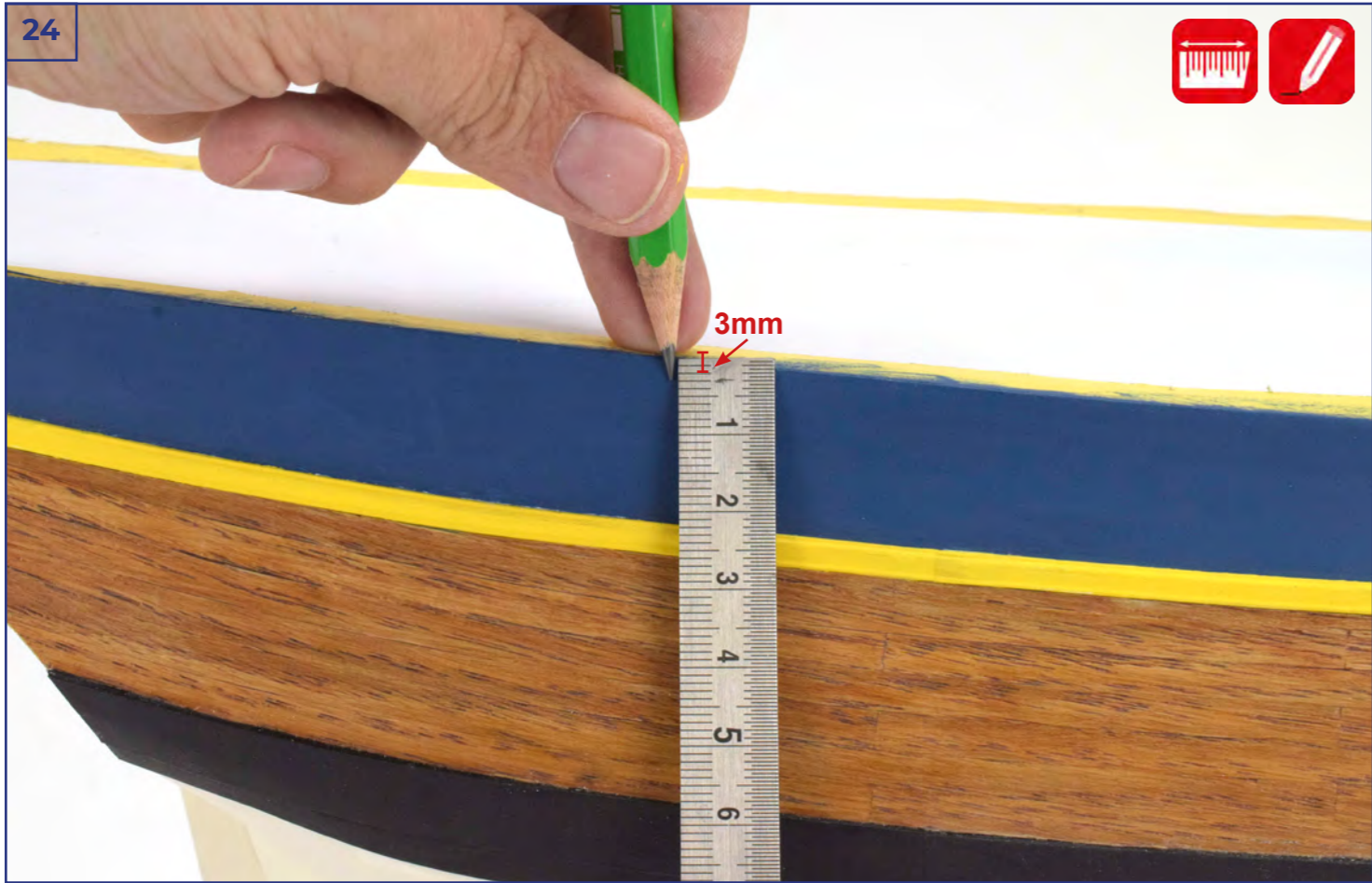

25



26



01

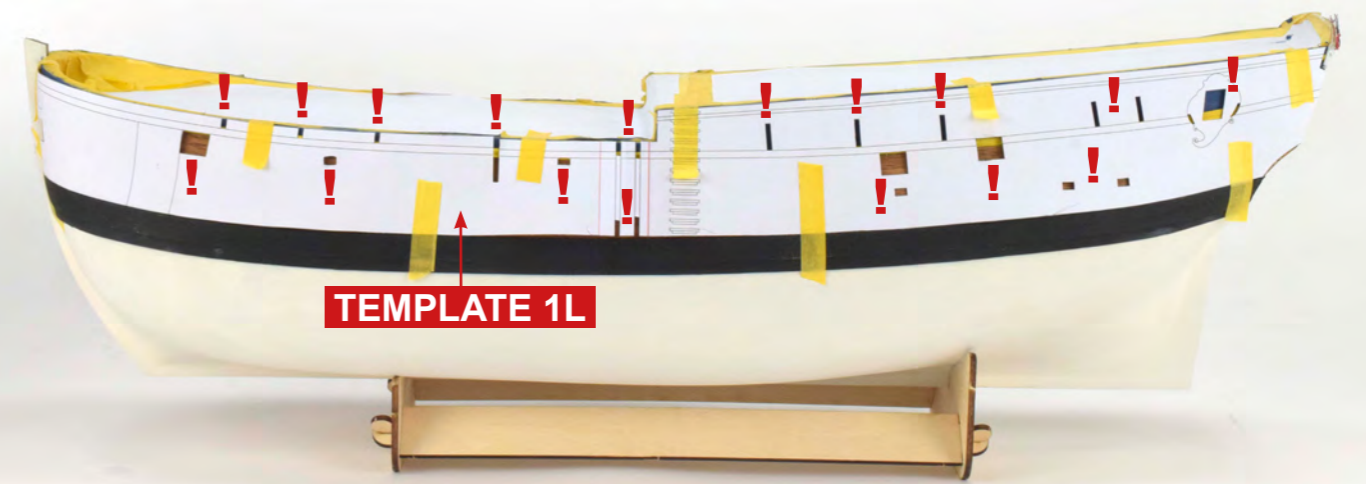

02

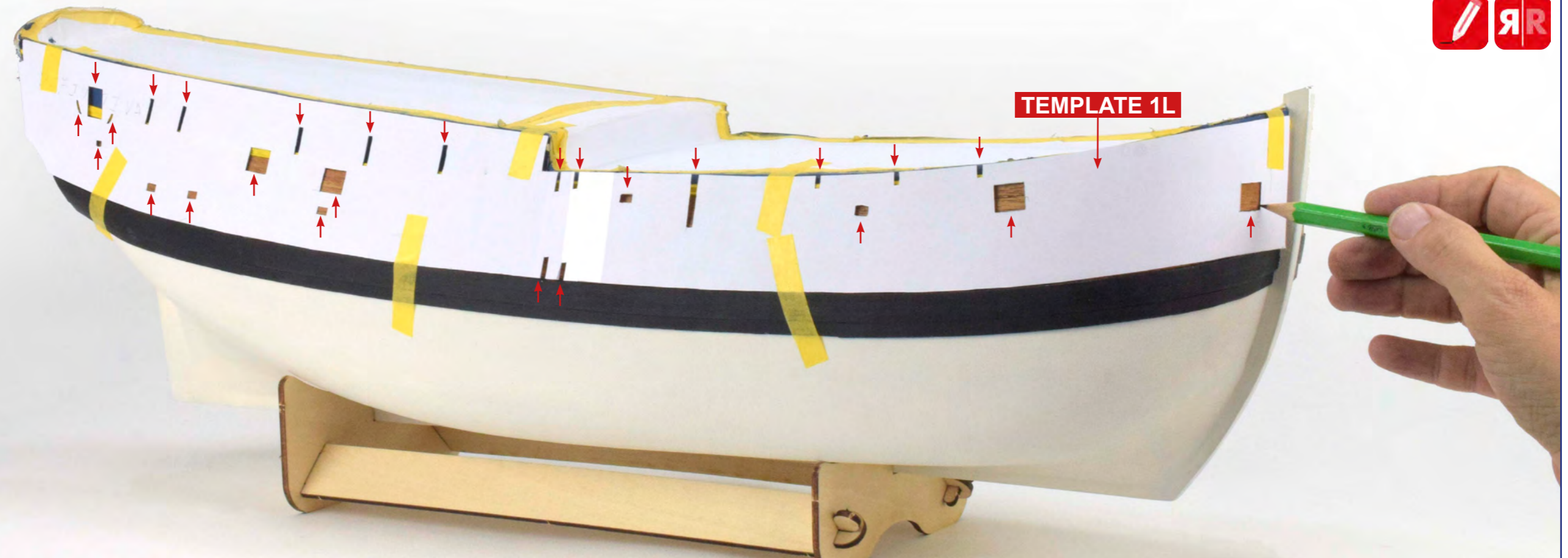

03

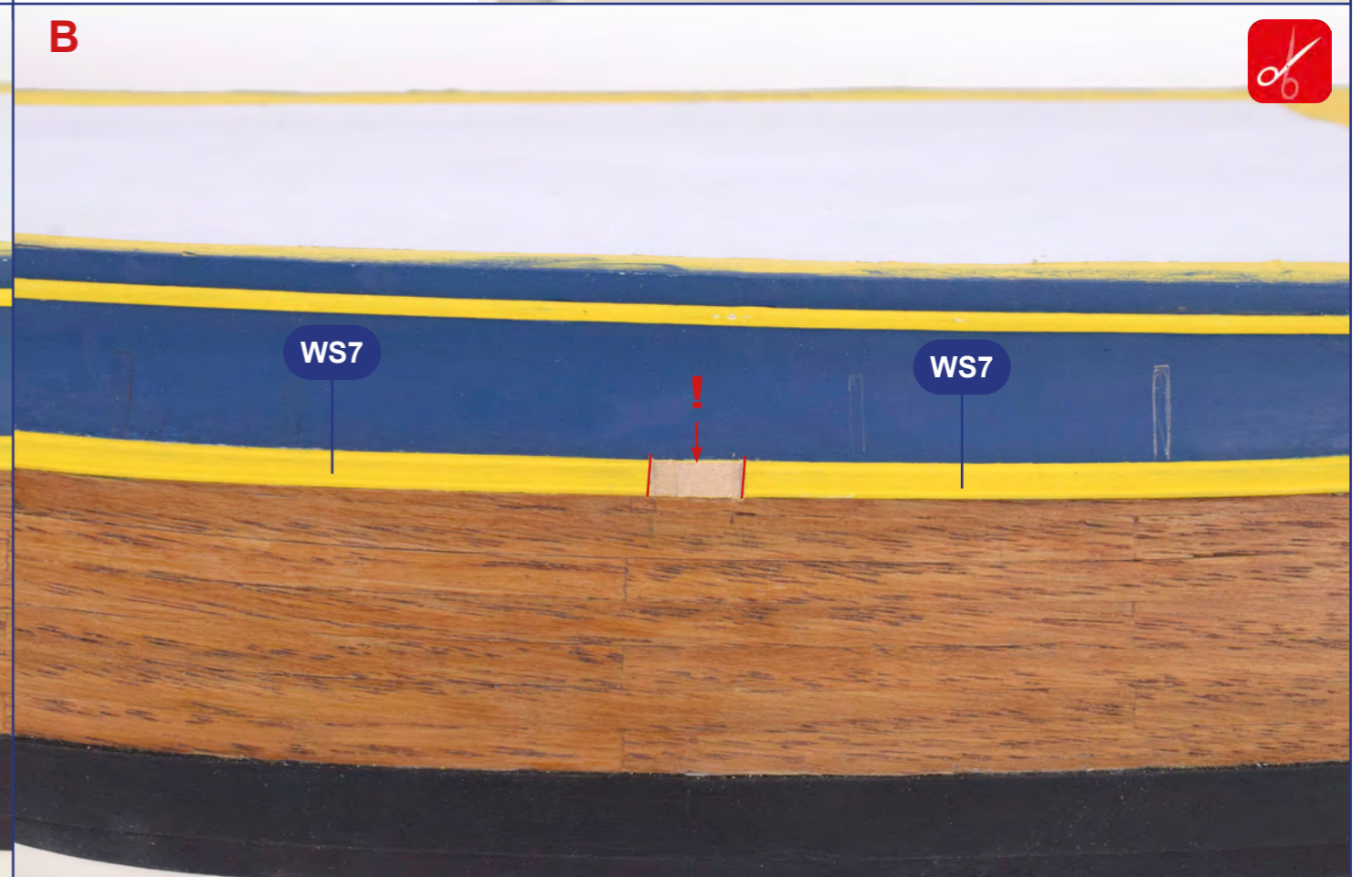
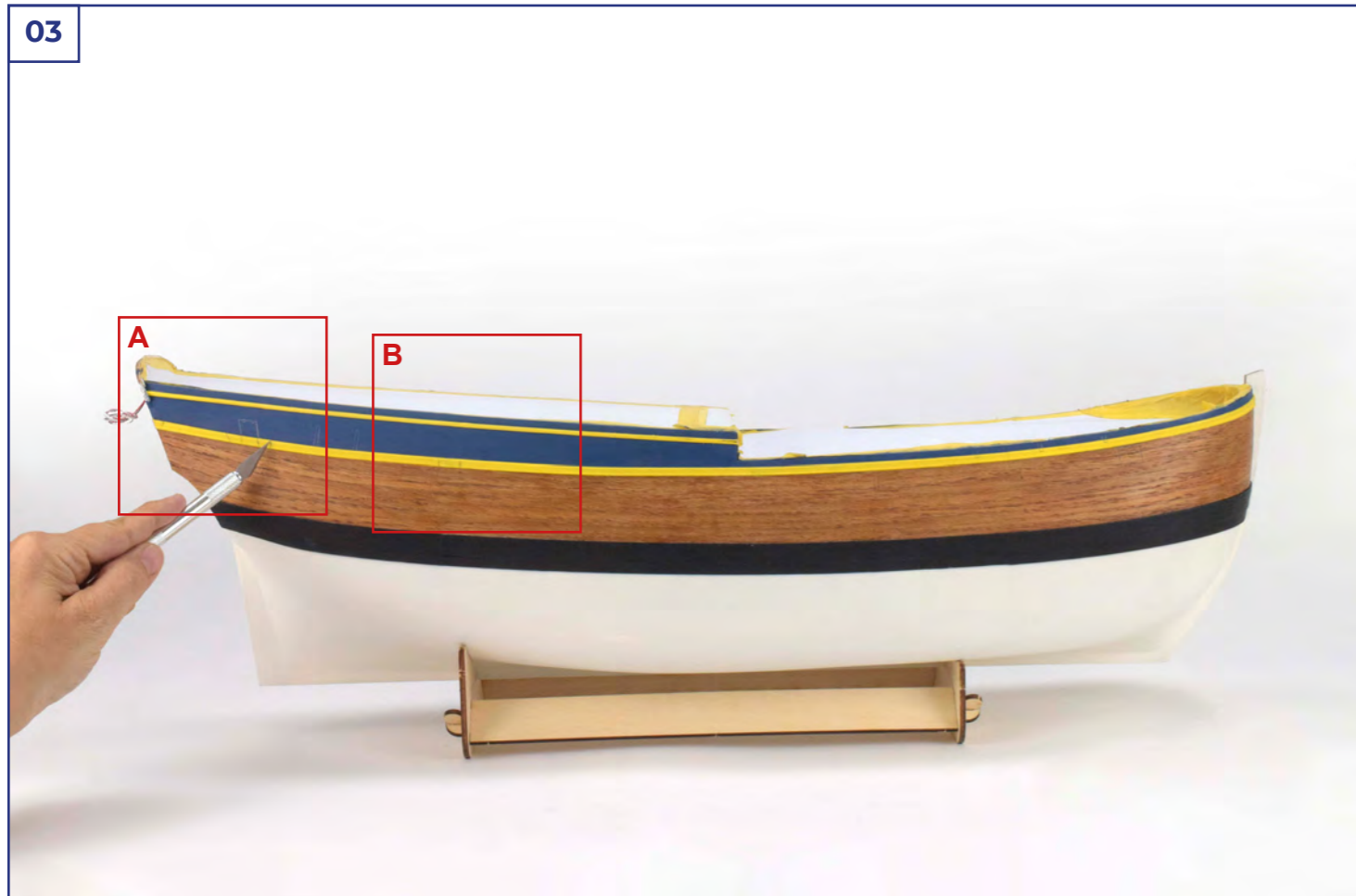

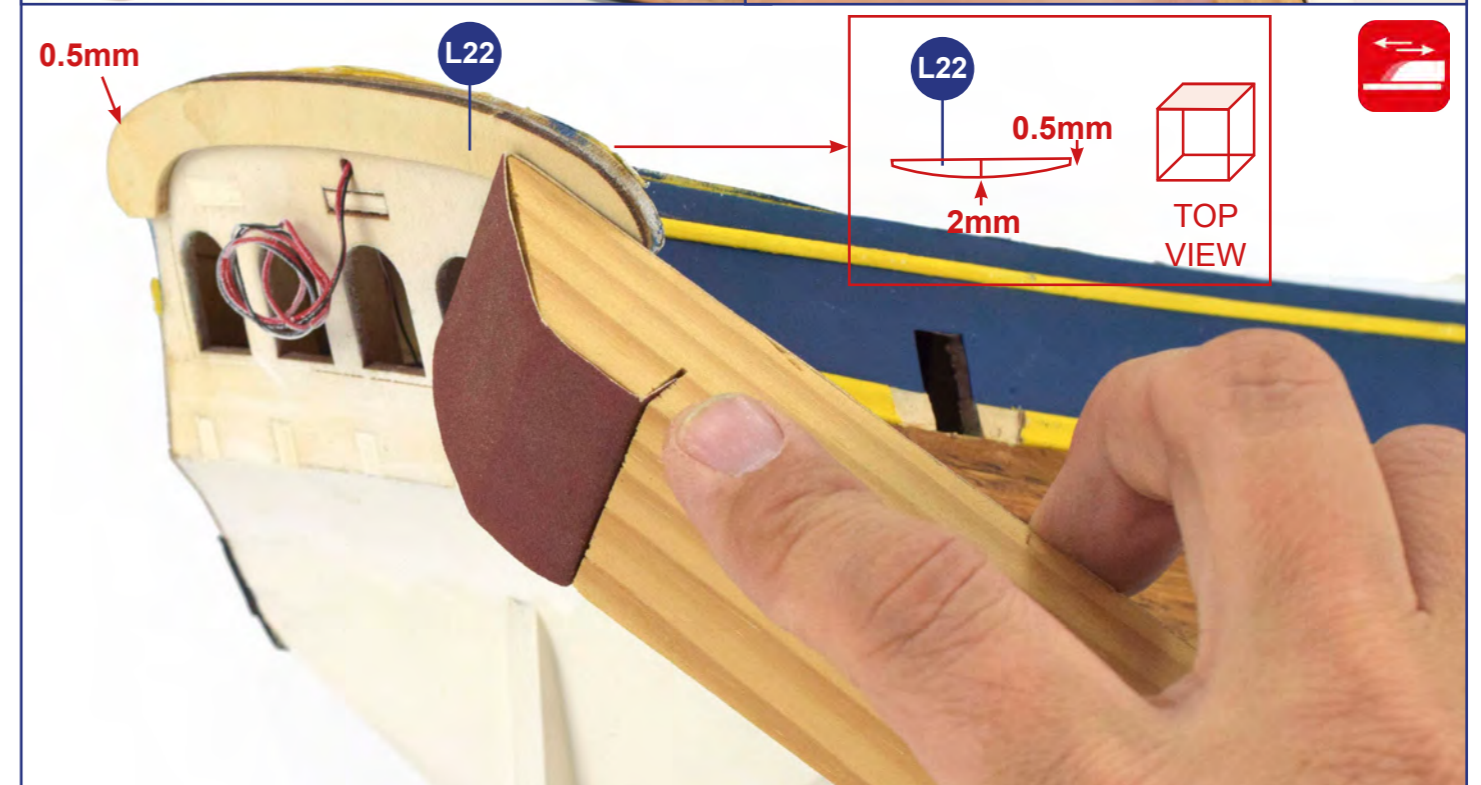
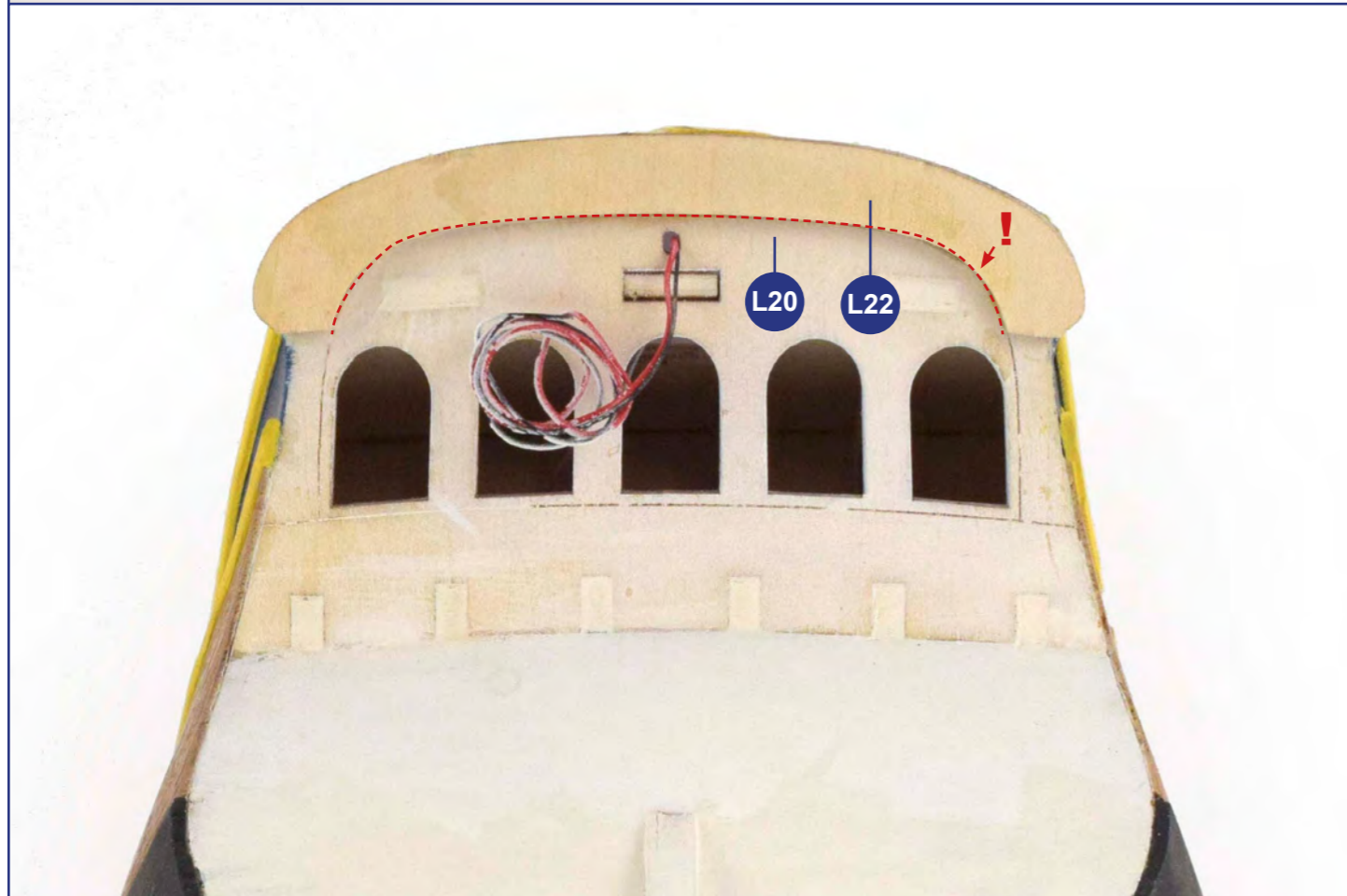

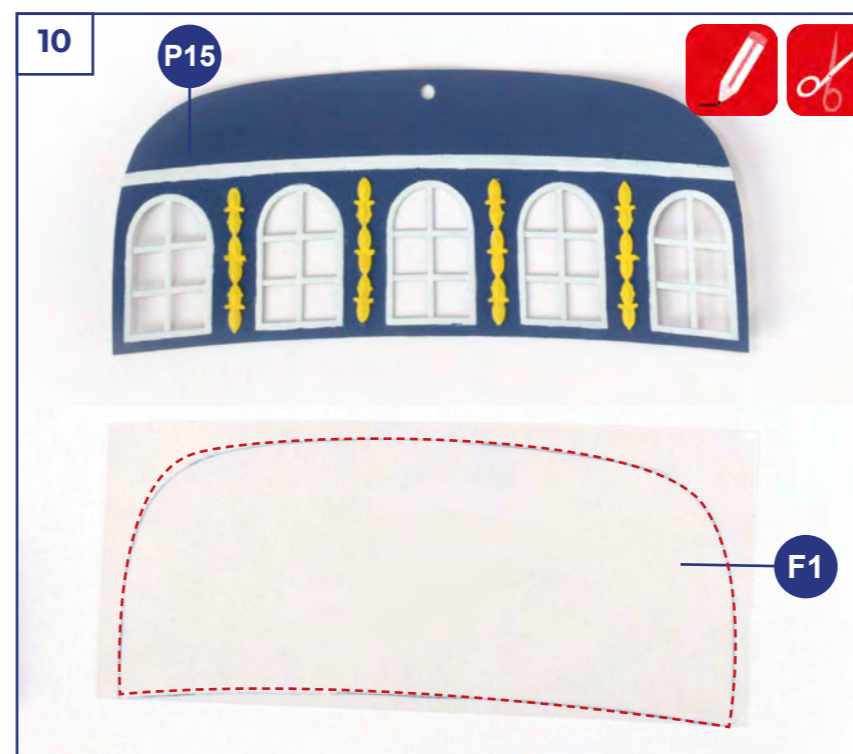
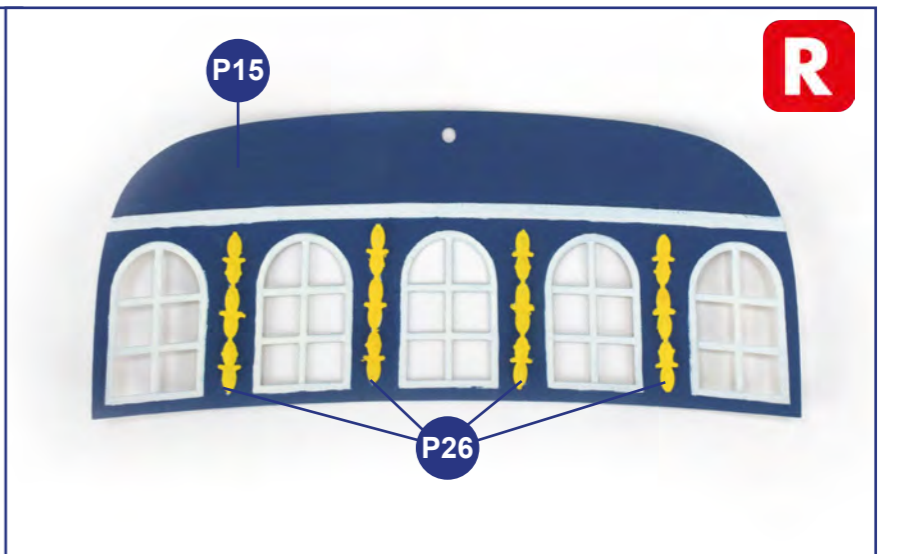
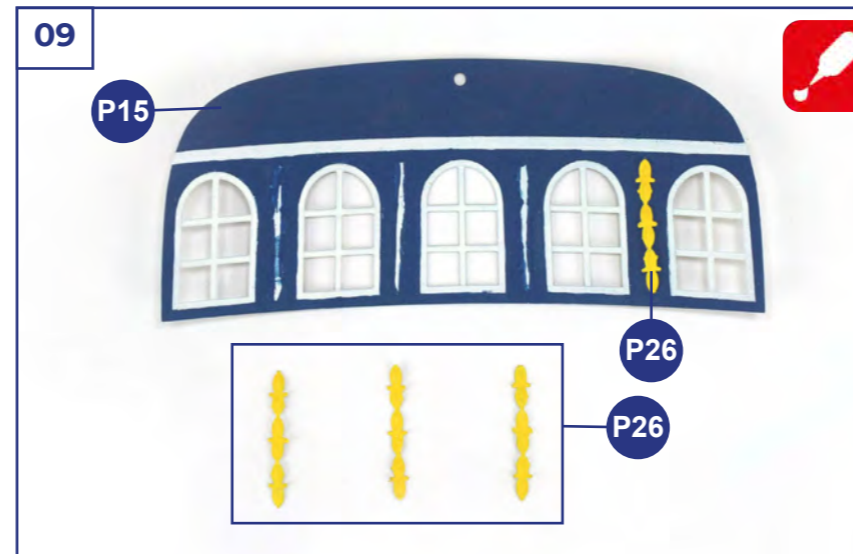
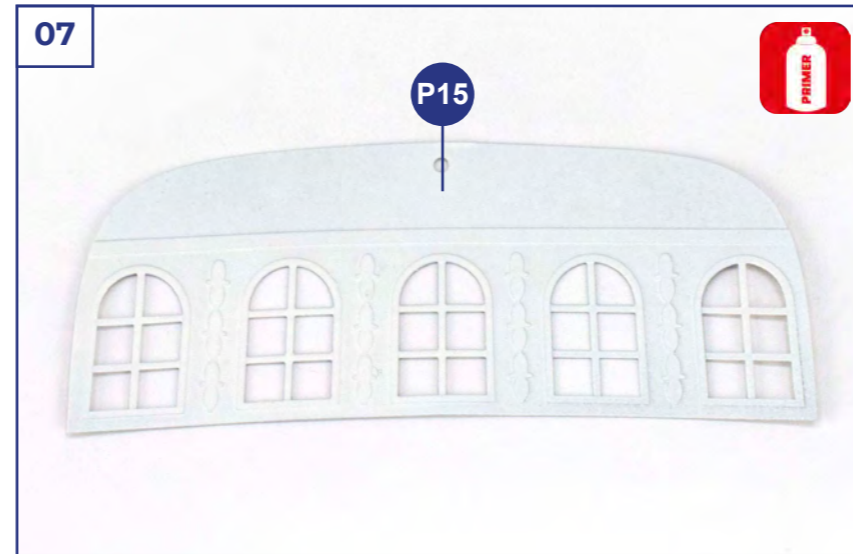
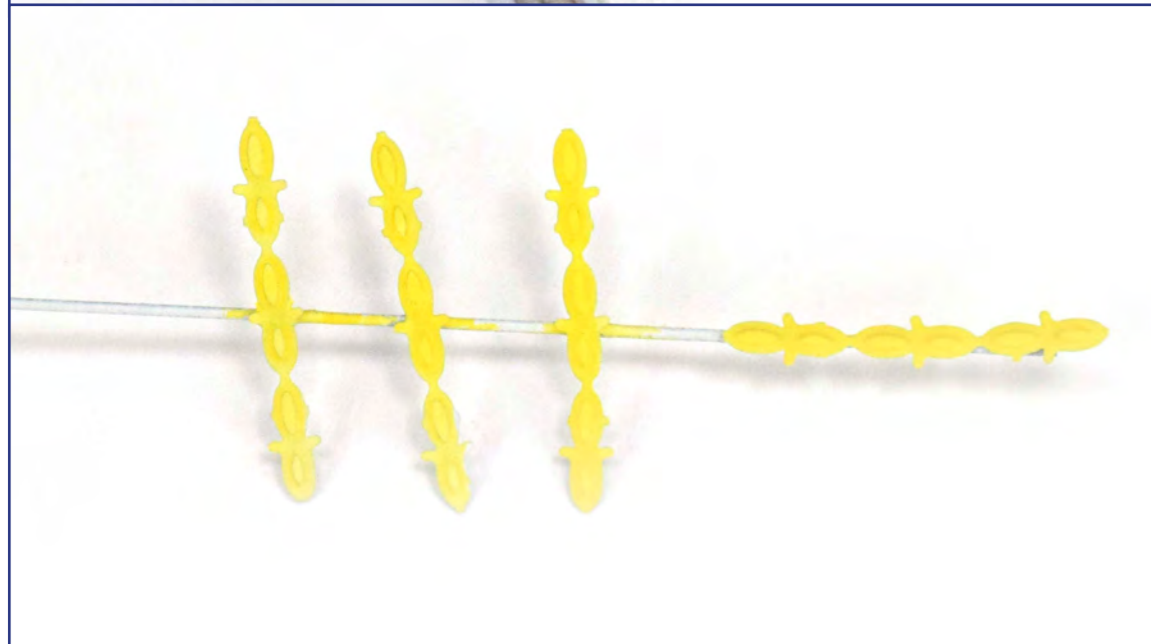
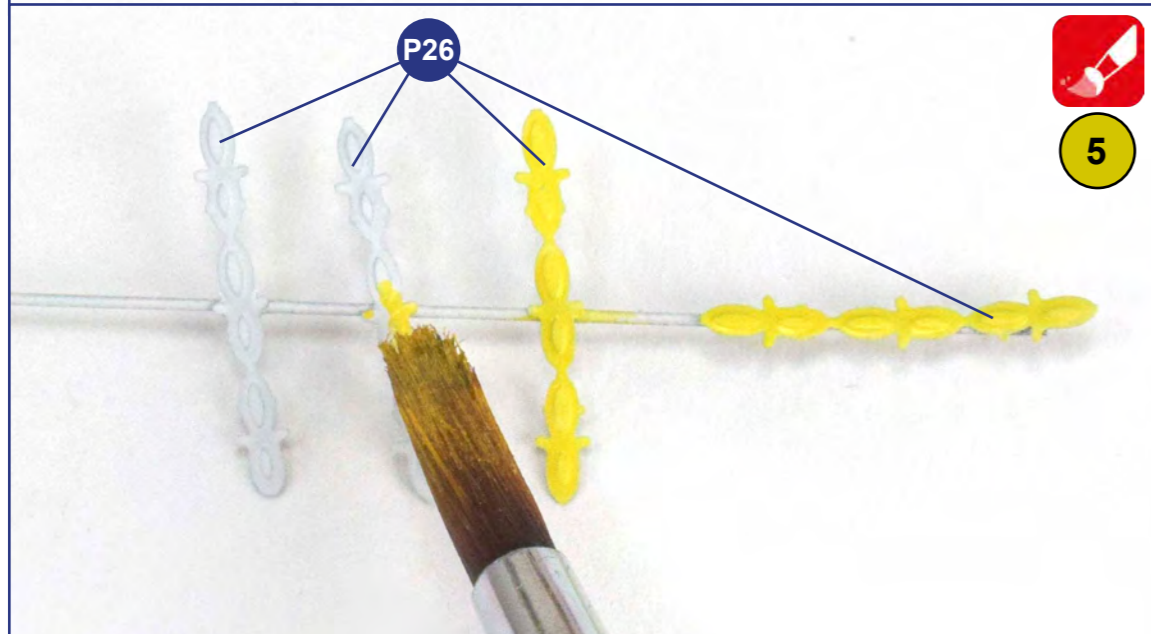
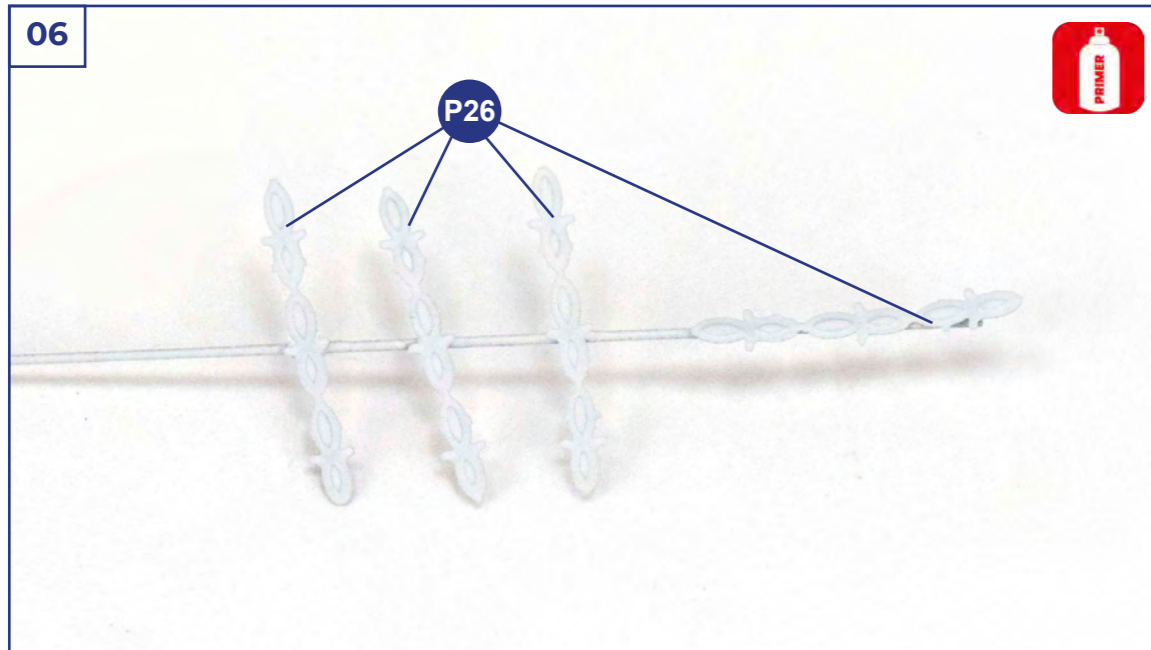

04

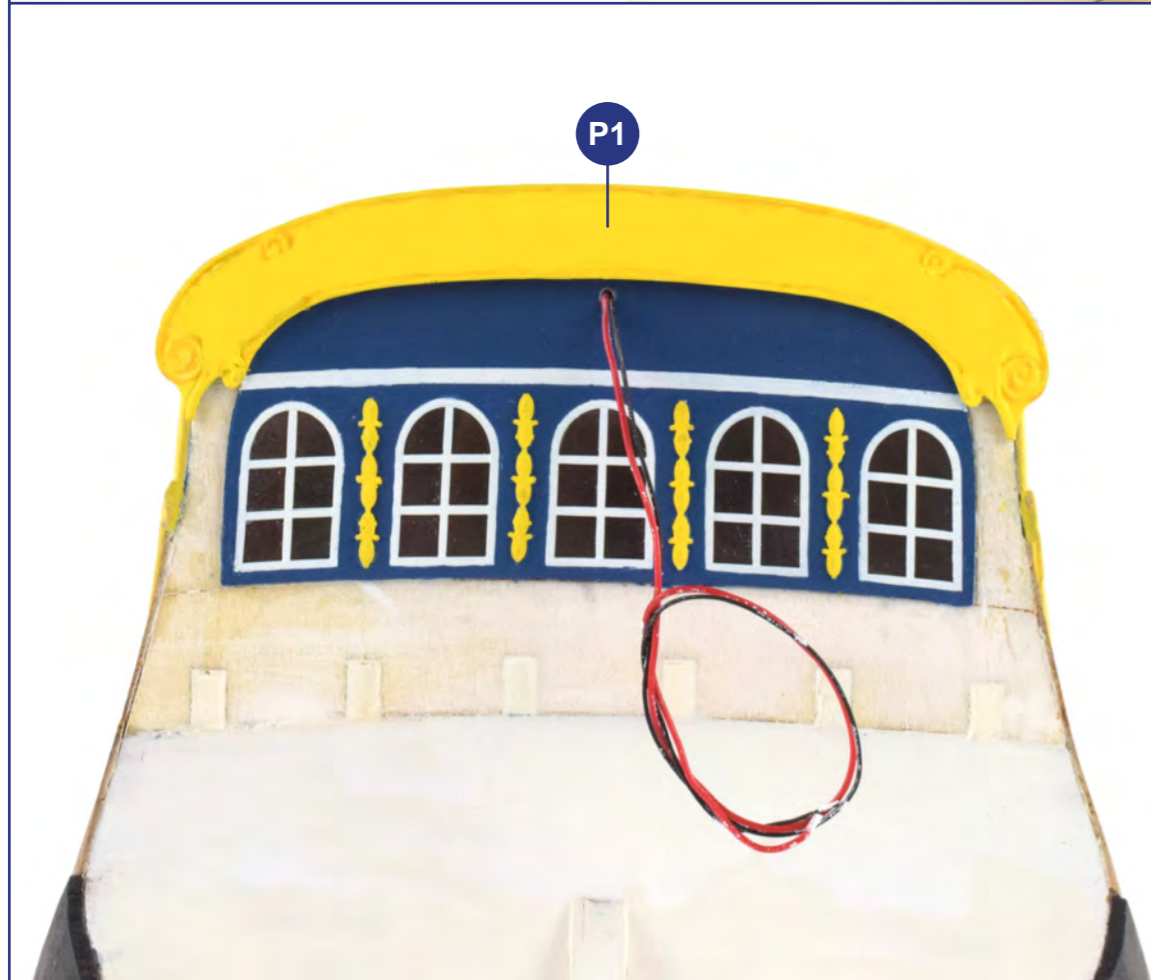
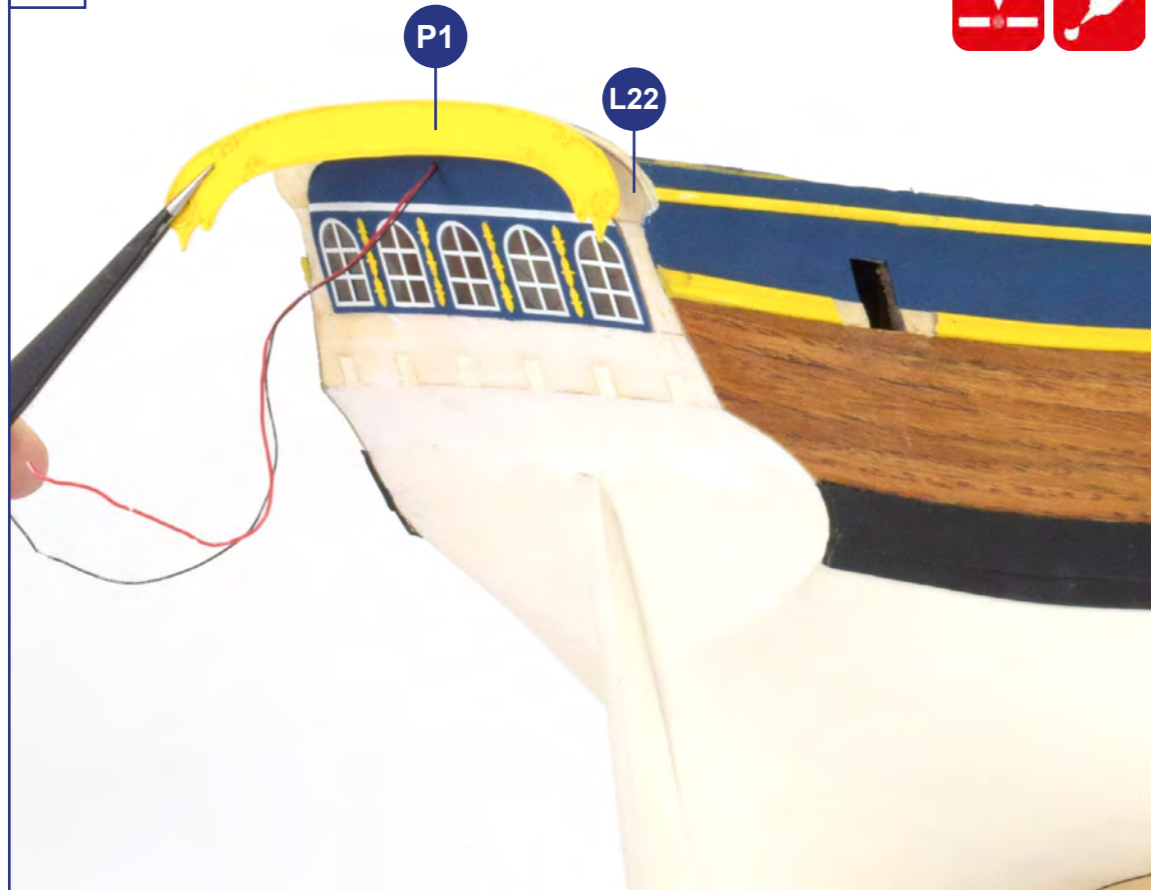

05

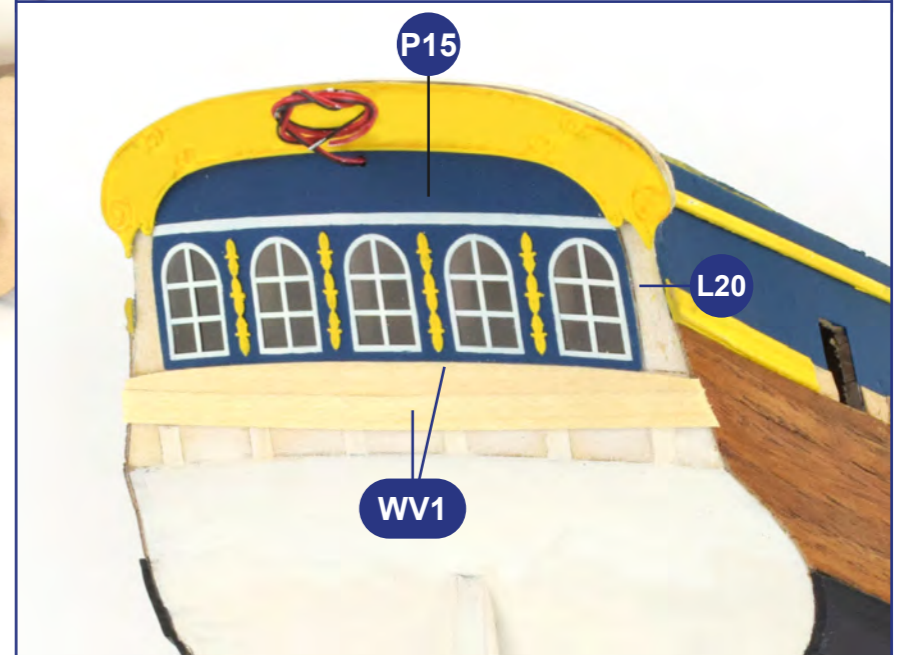
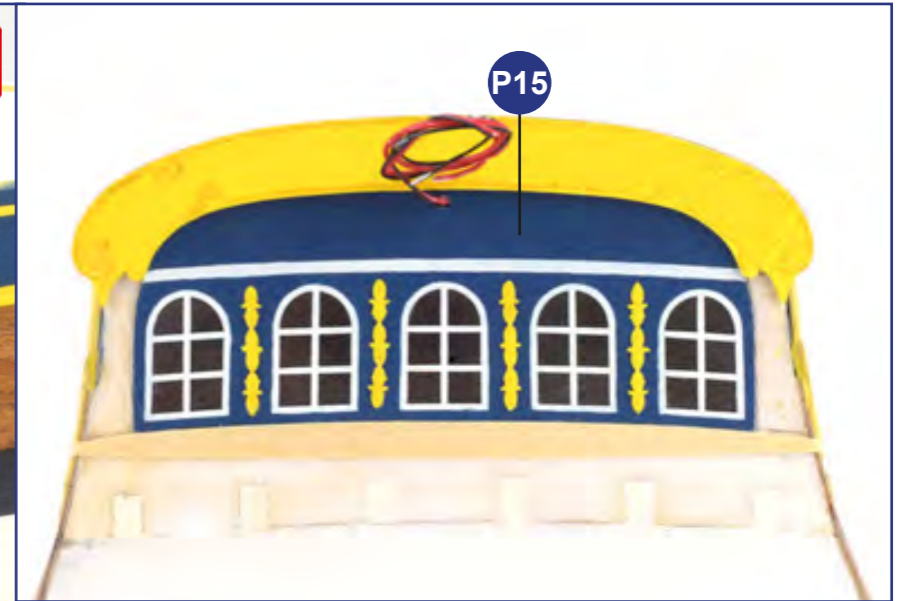

06



WV1



07



2

WV1



08



6

WS3

Q8



09



WS9

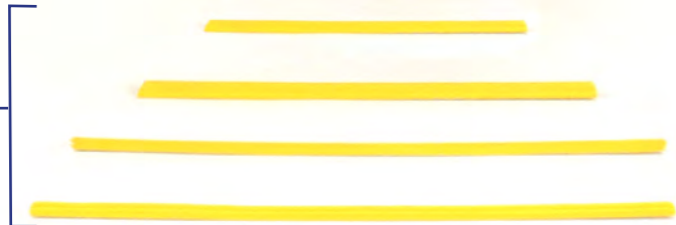

10



A

2x2

Micro Shapers
ref. 27300
Sold separately



B

2x2

11

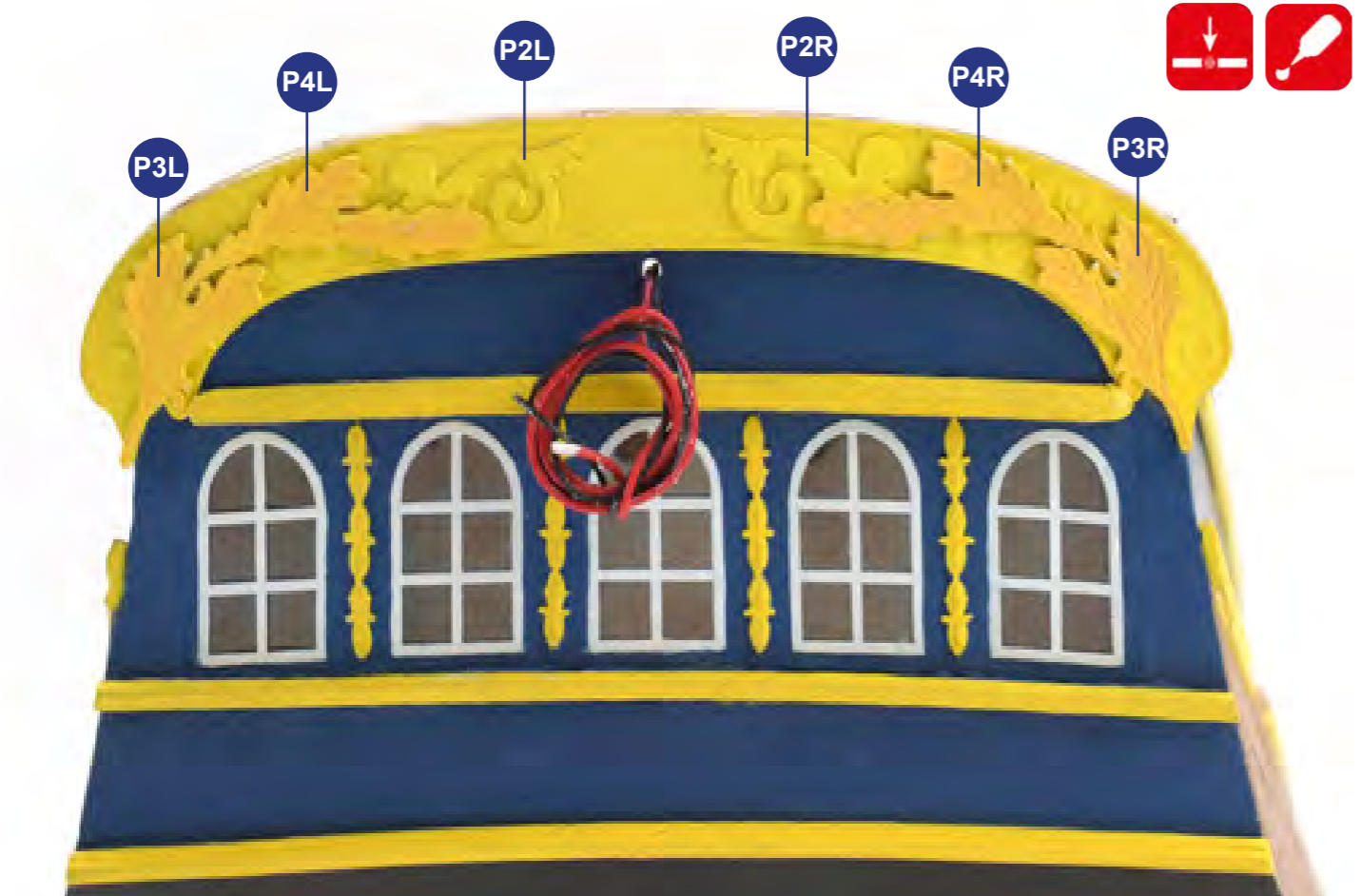
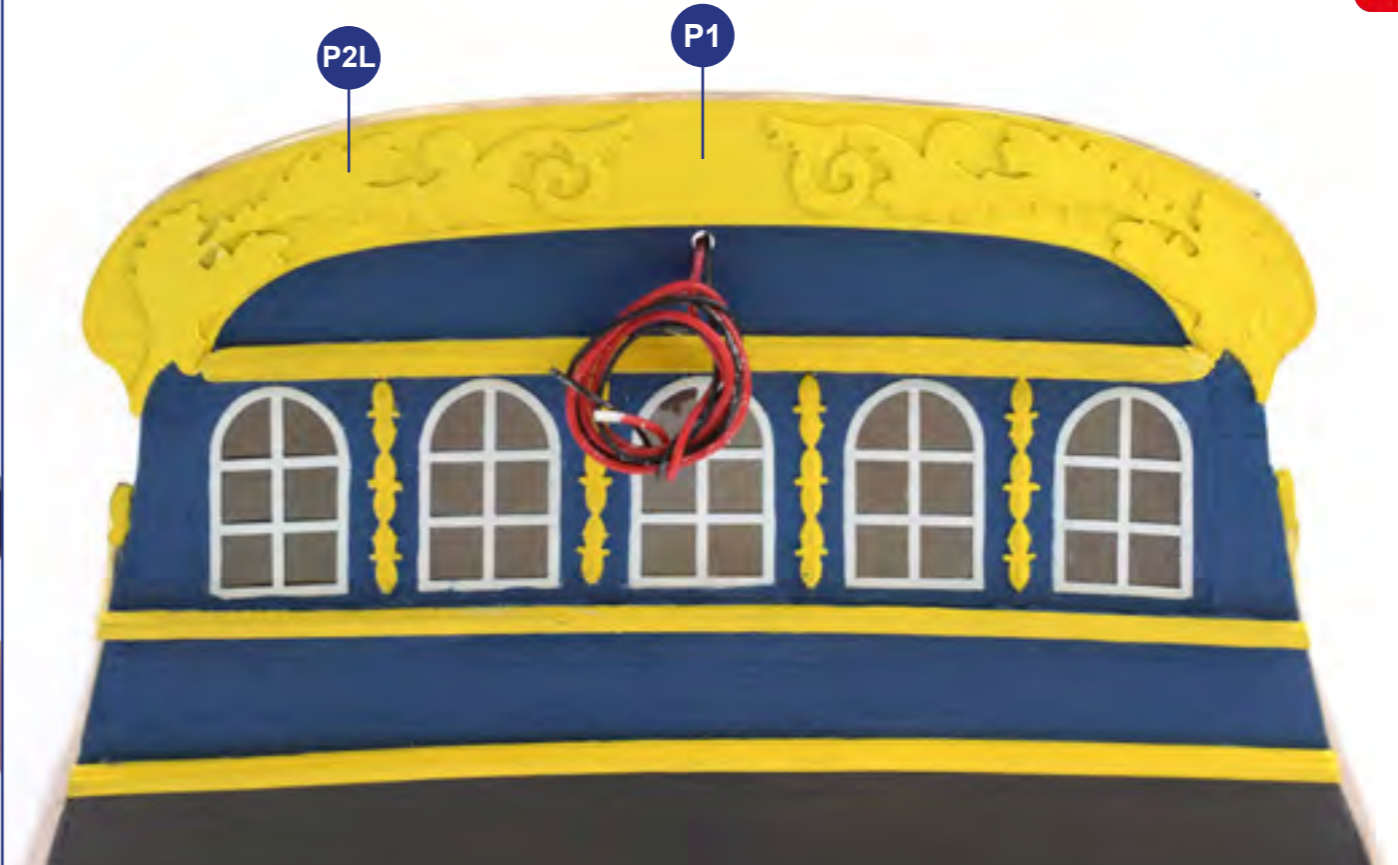
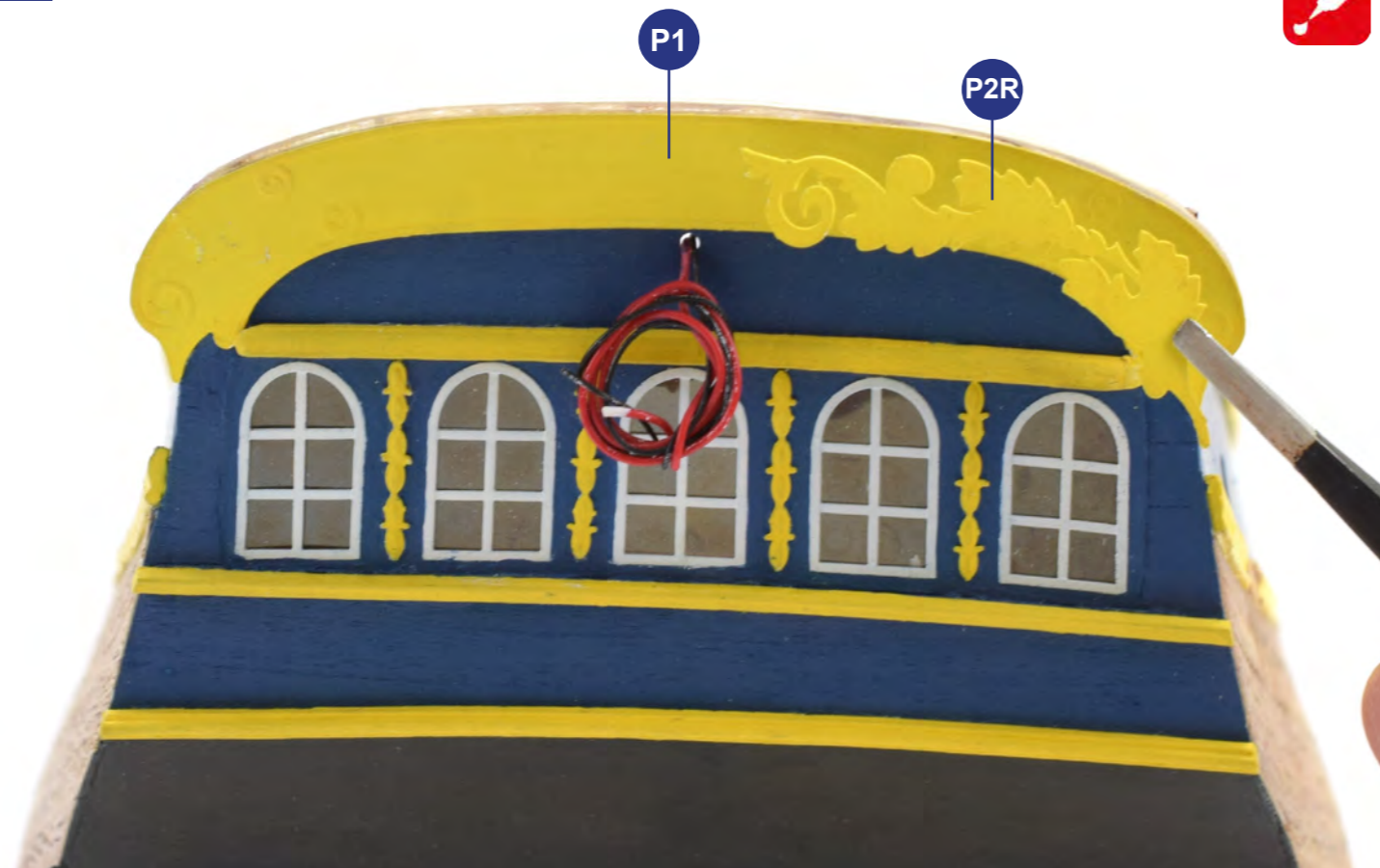

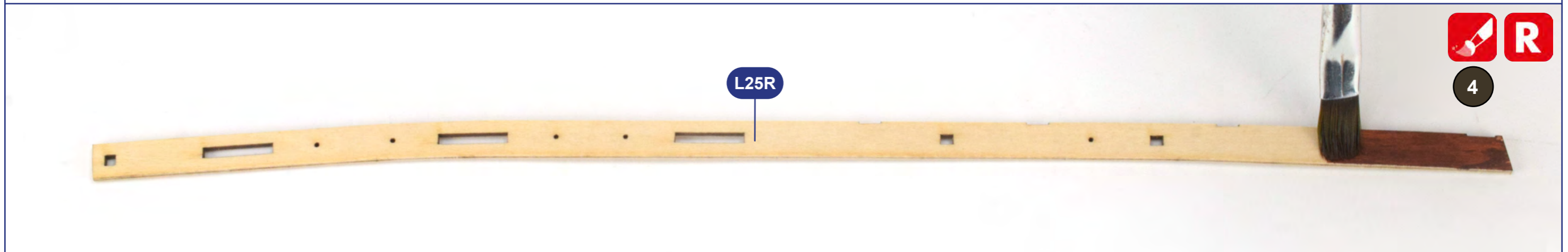
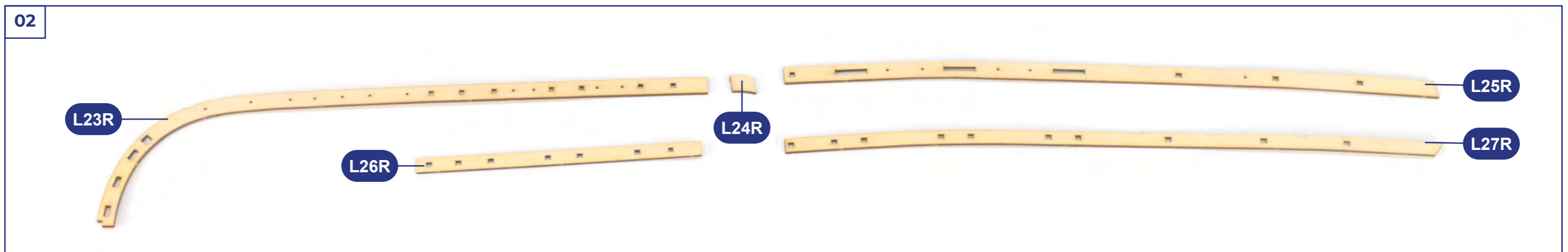

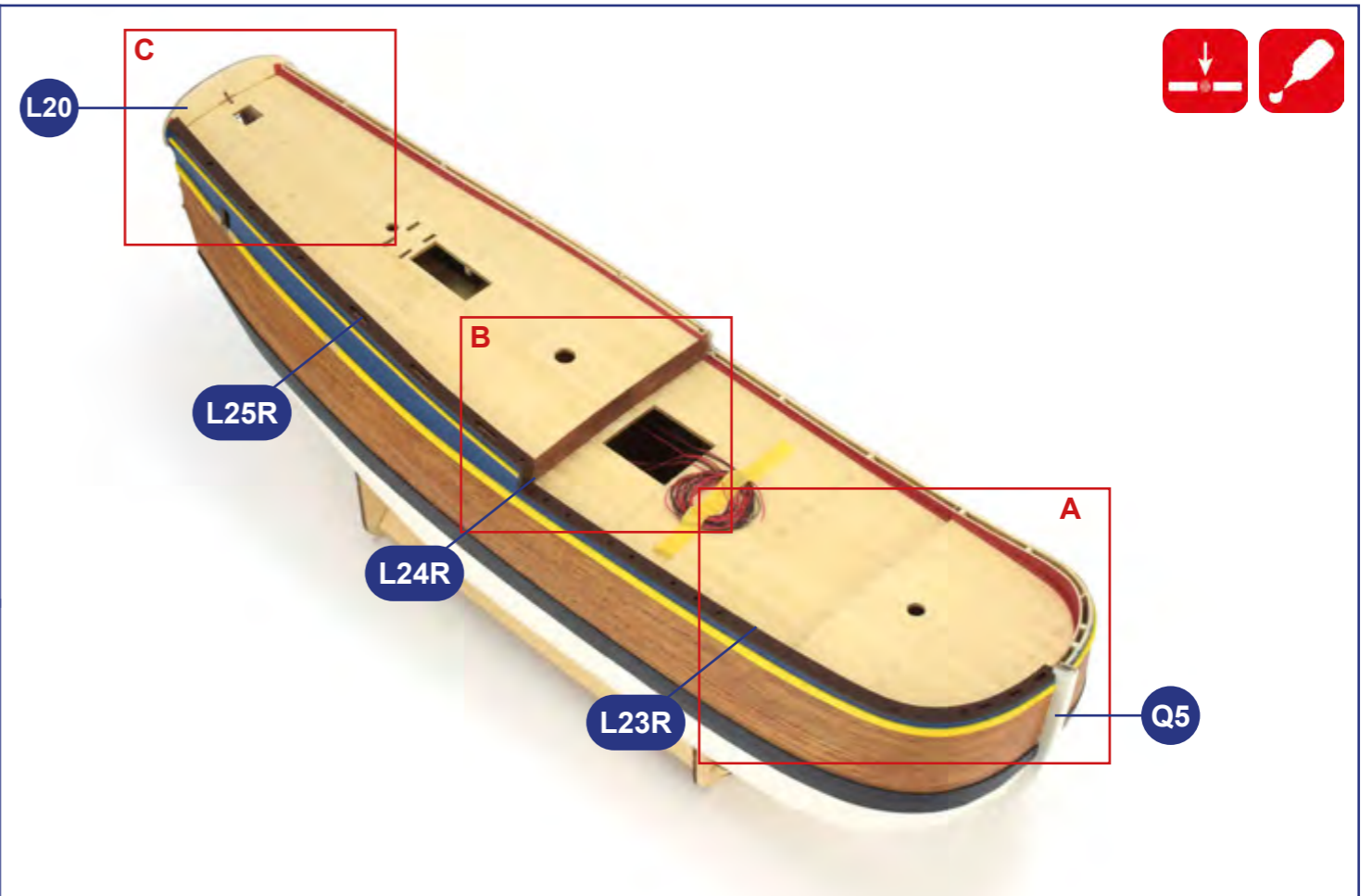
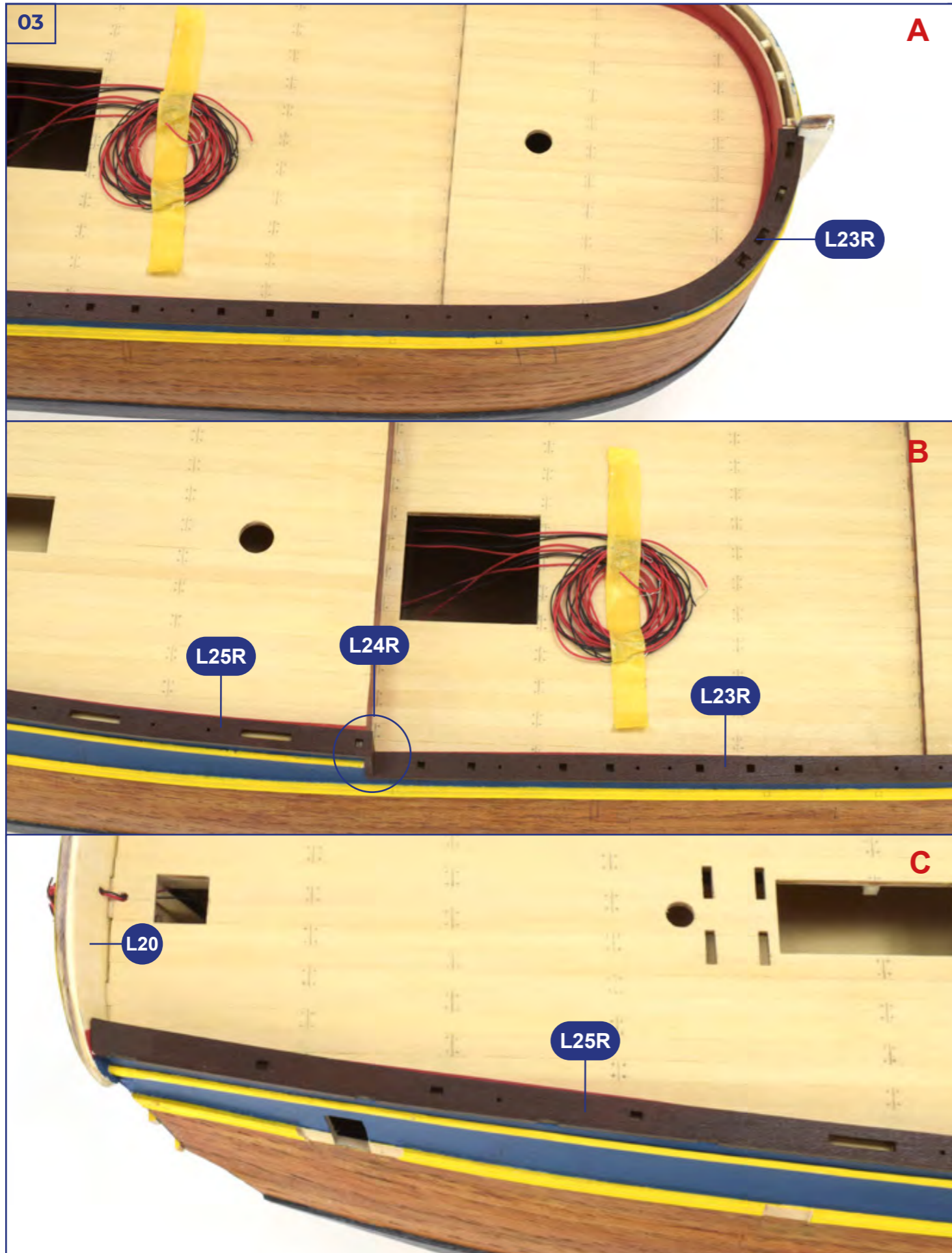

04

TEMPLATE 2

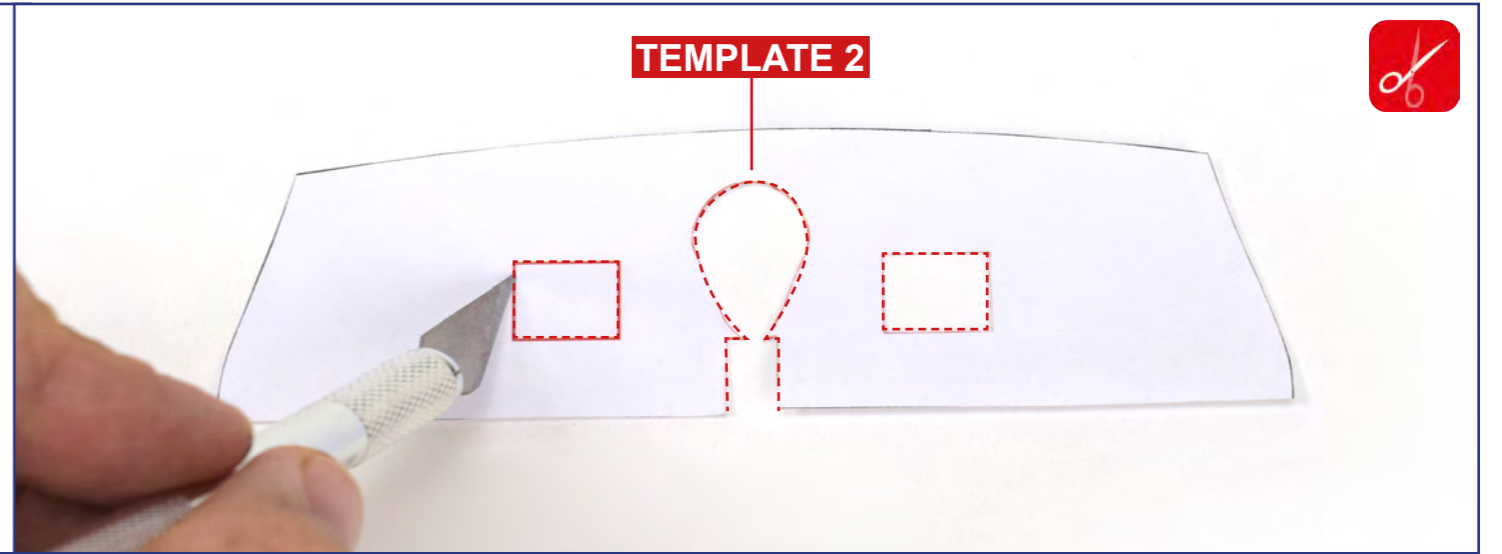
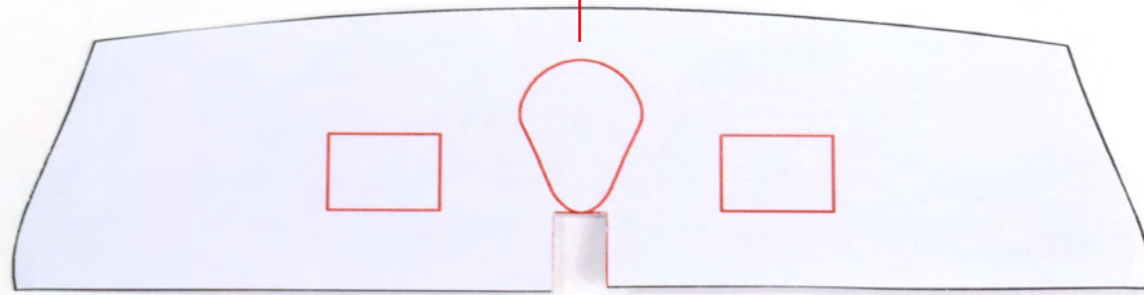

05

TEMPLATE 2

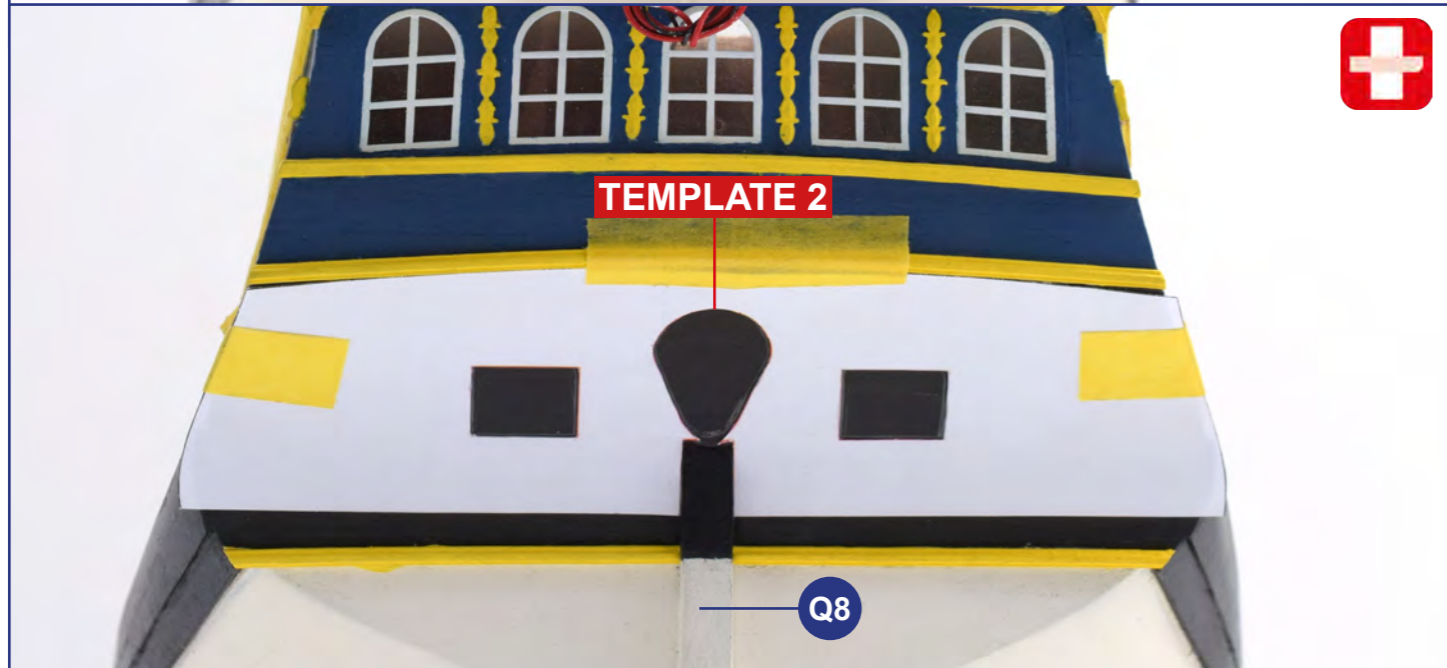

06





09



10

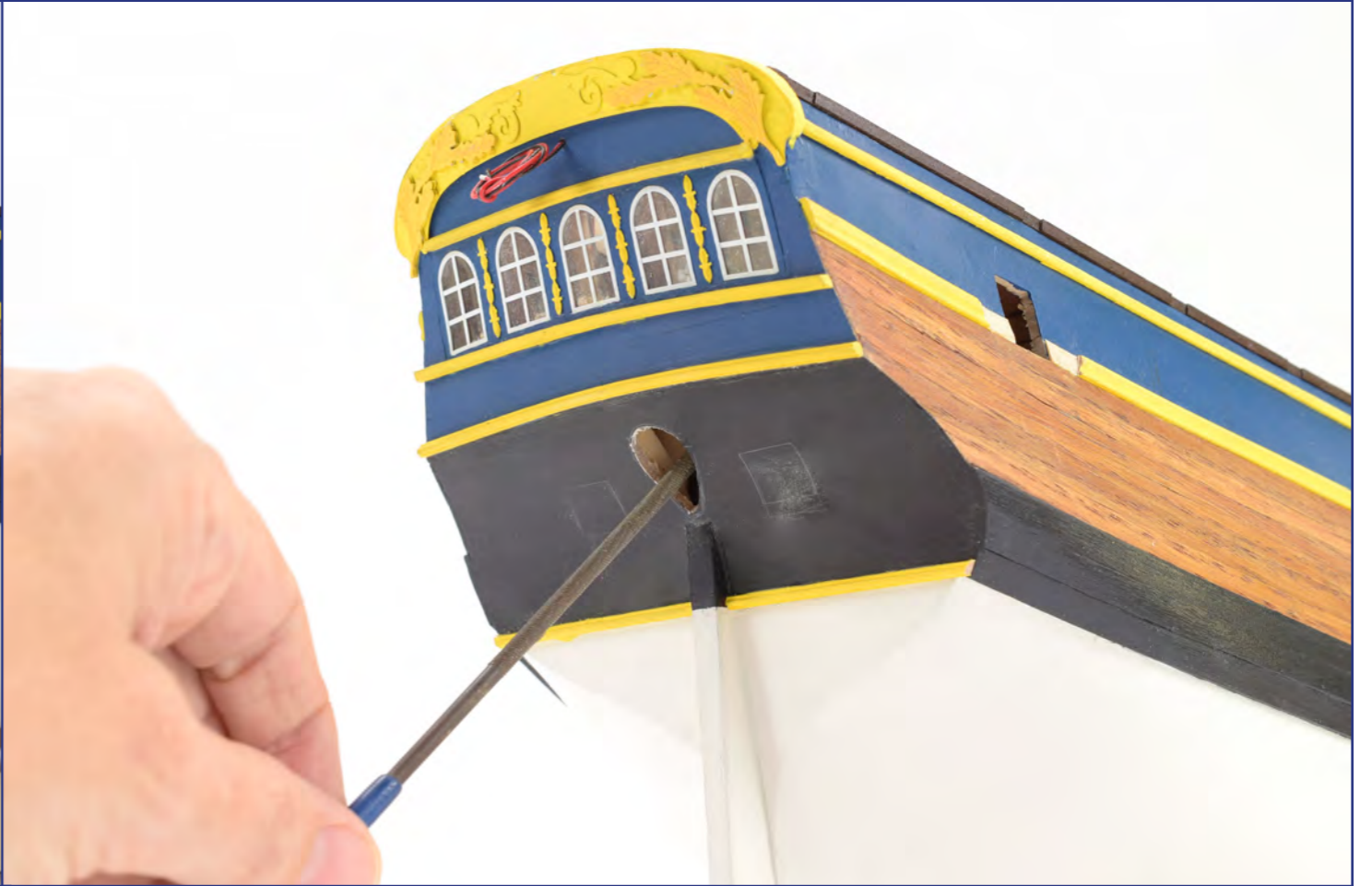

11



6

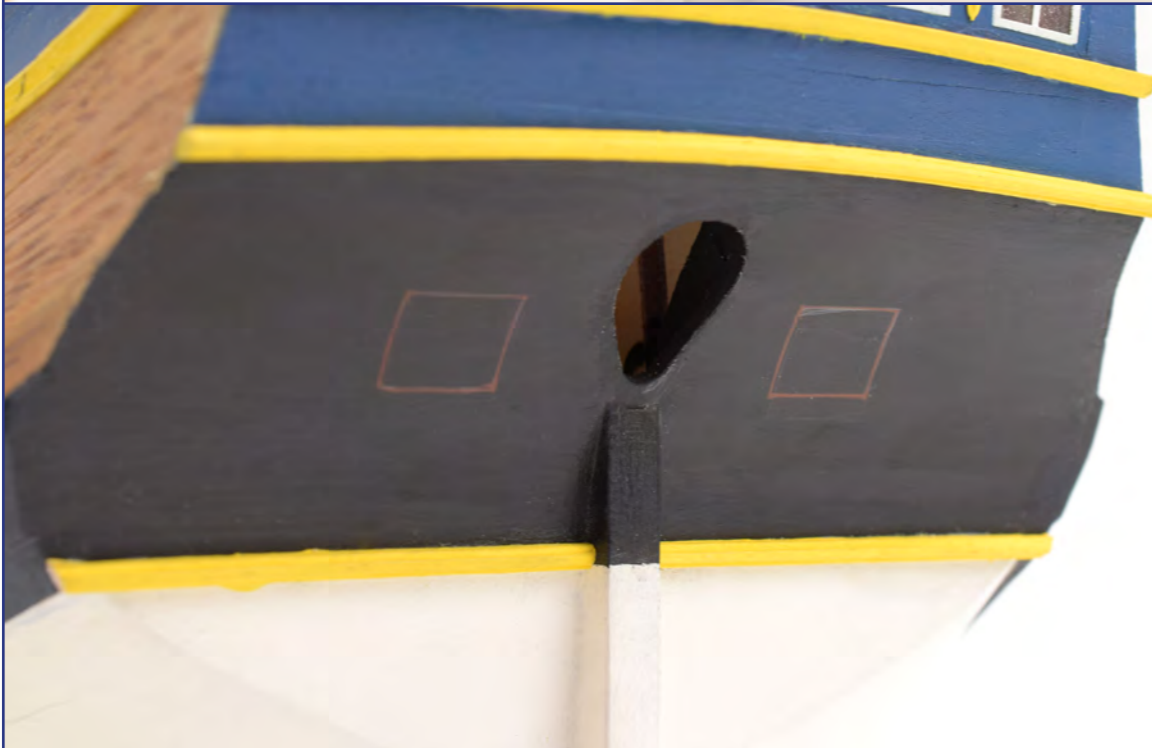
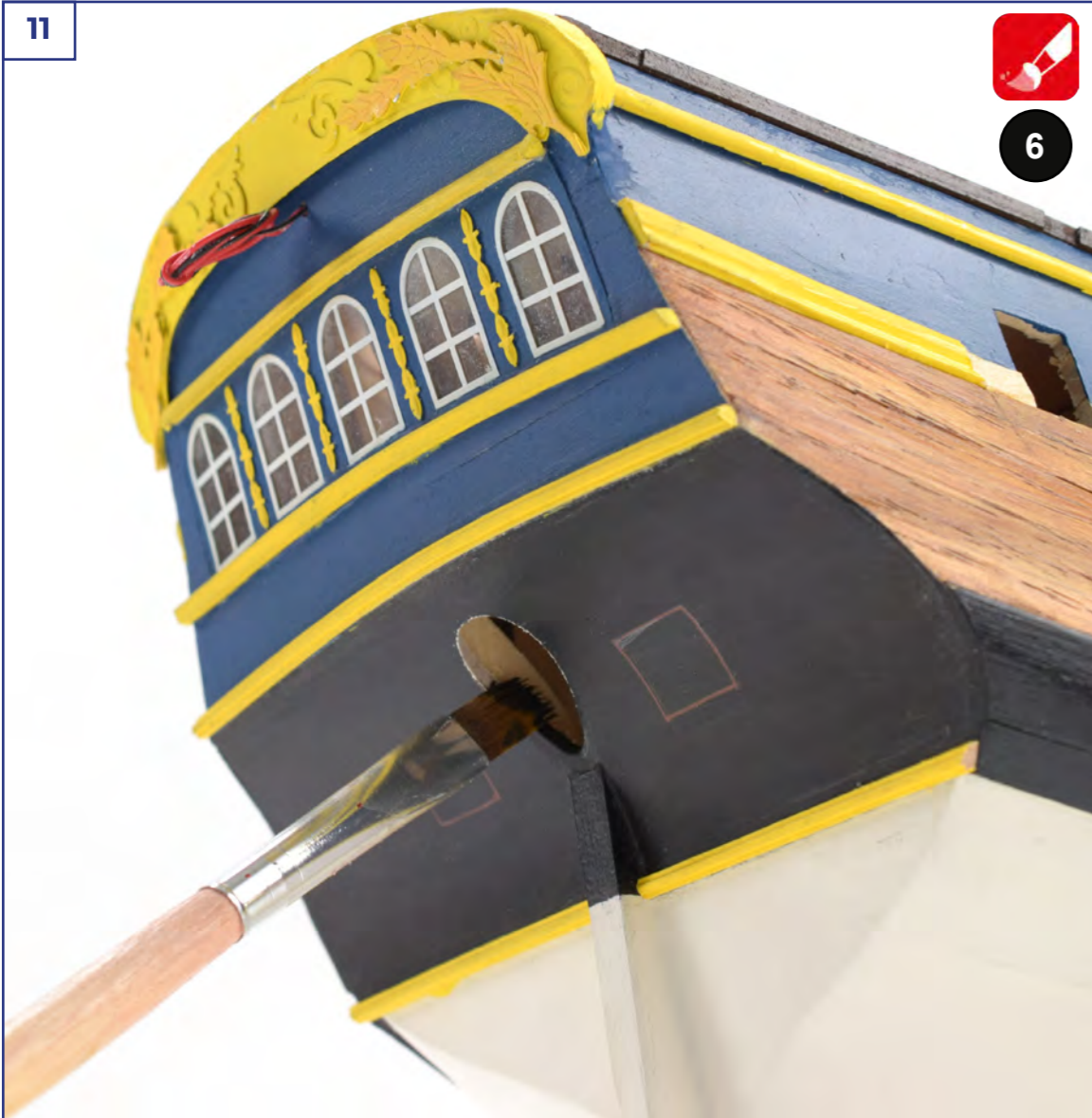

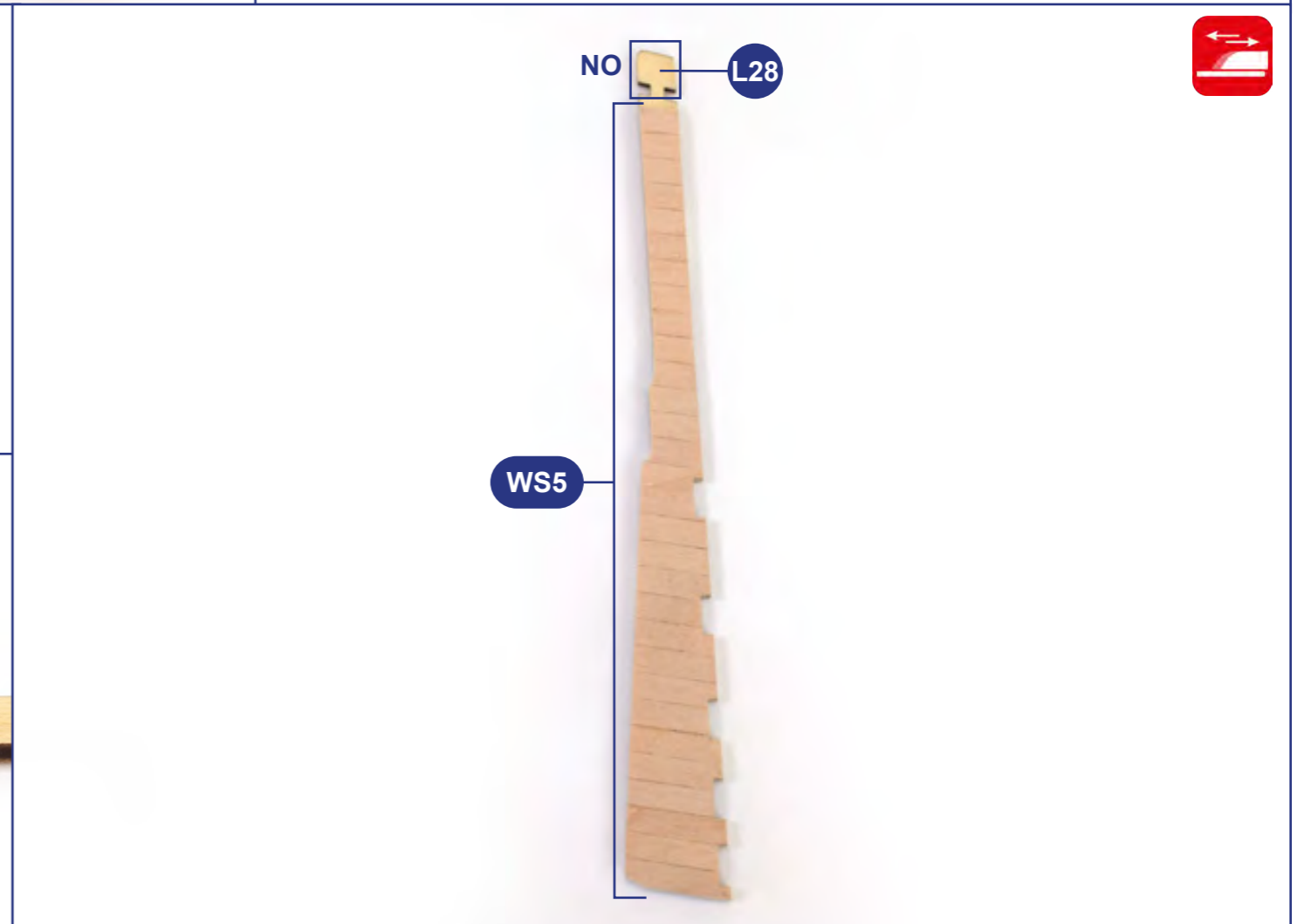
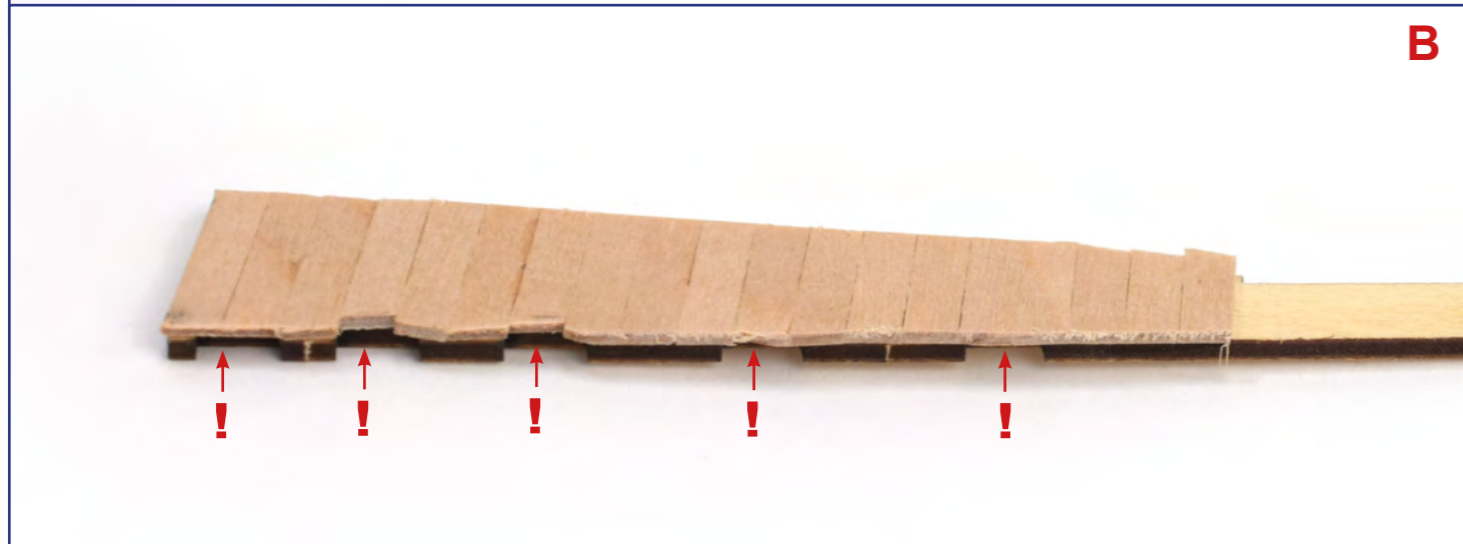
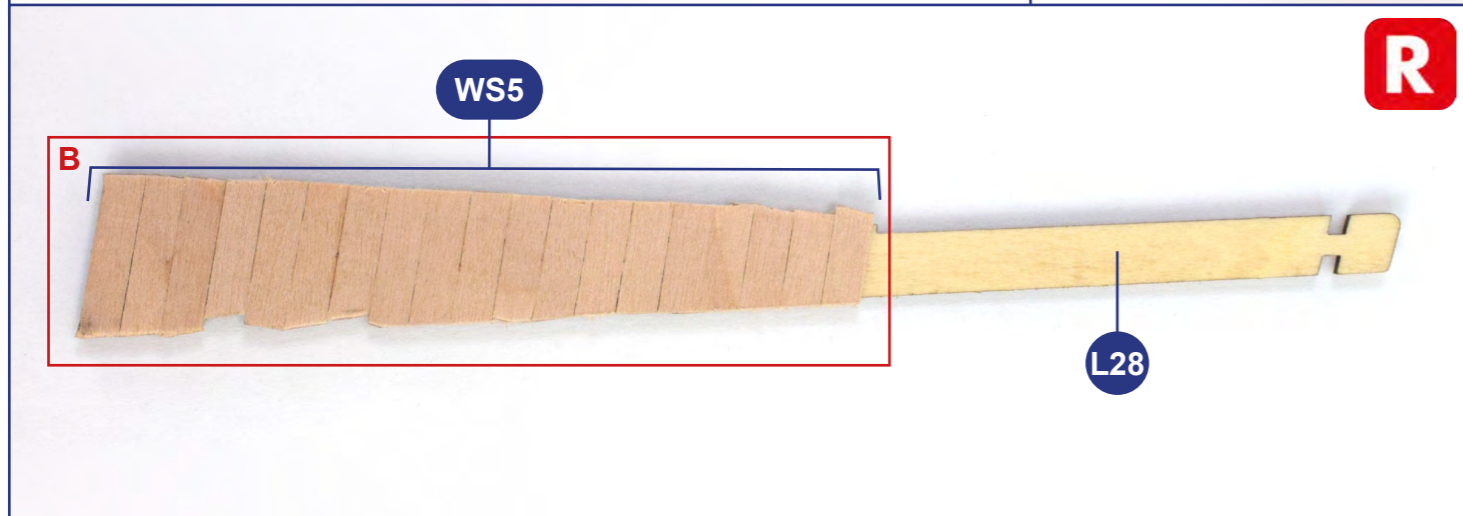

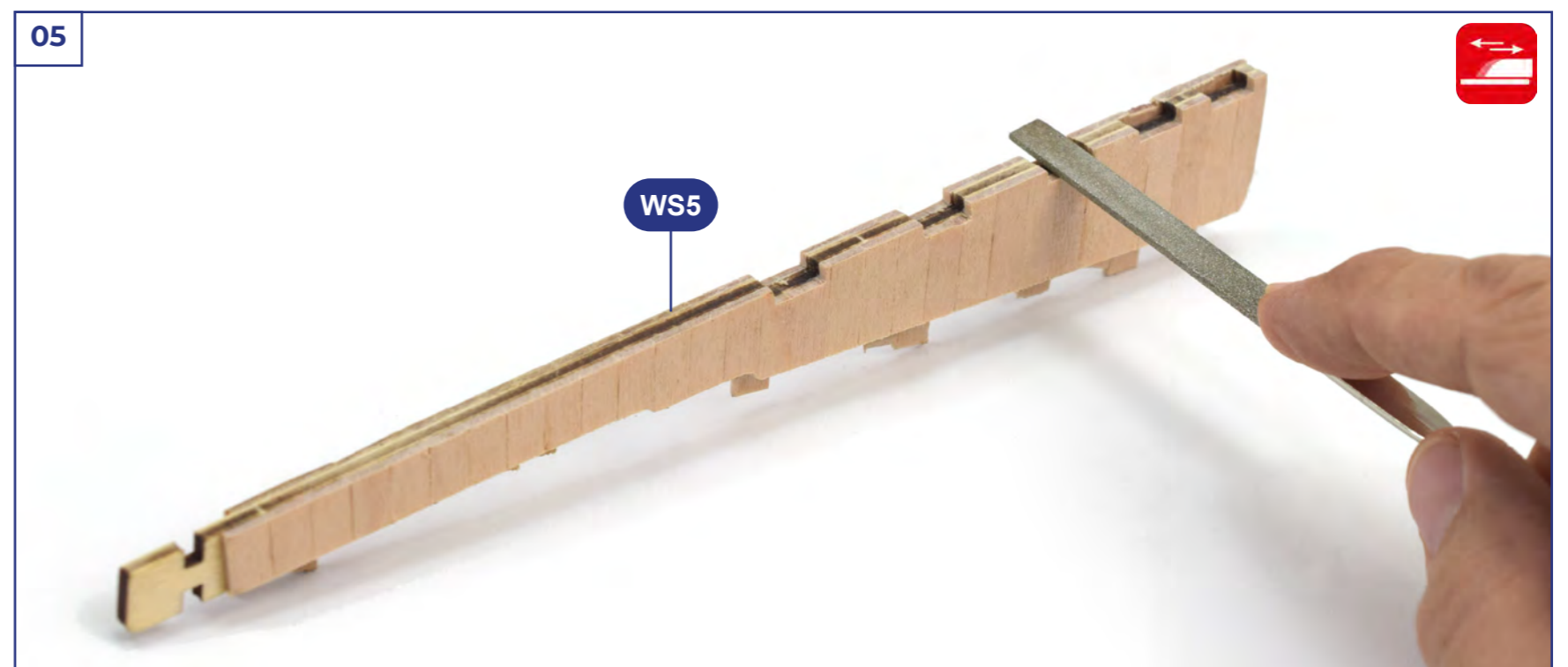
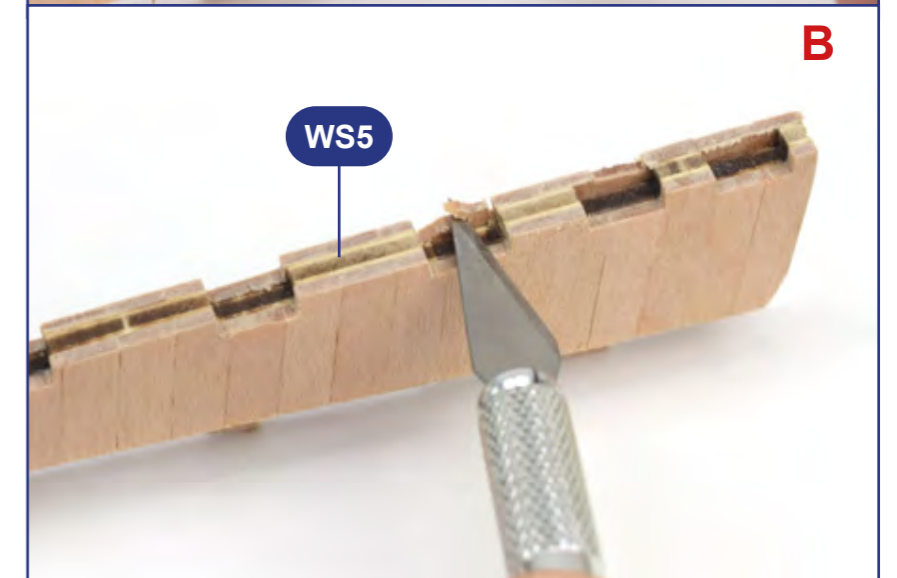
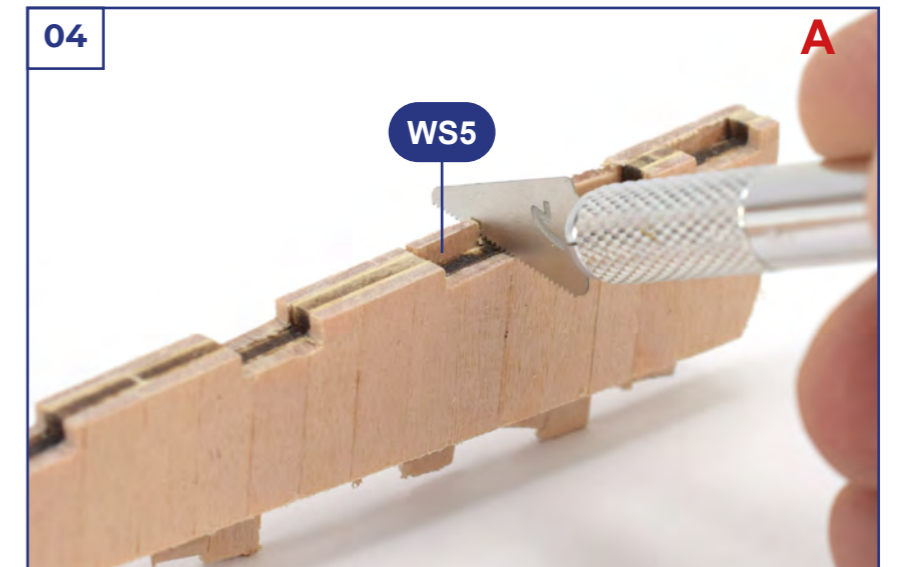
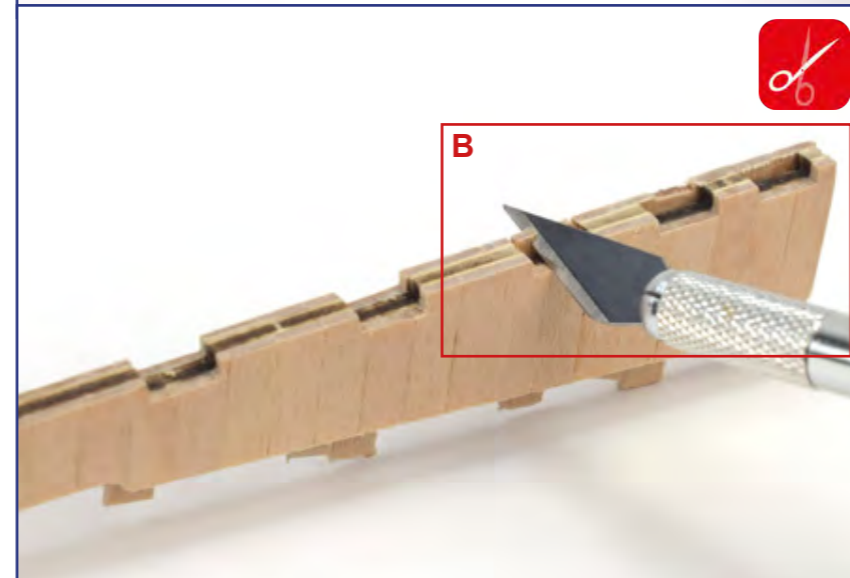
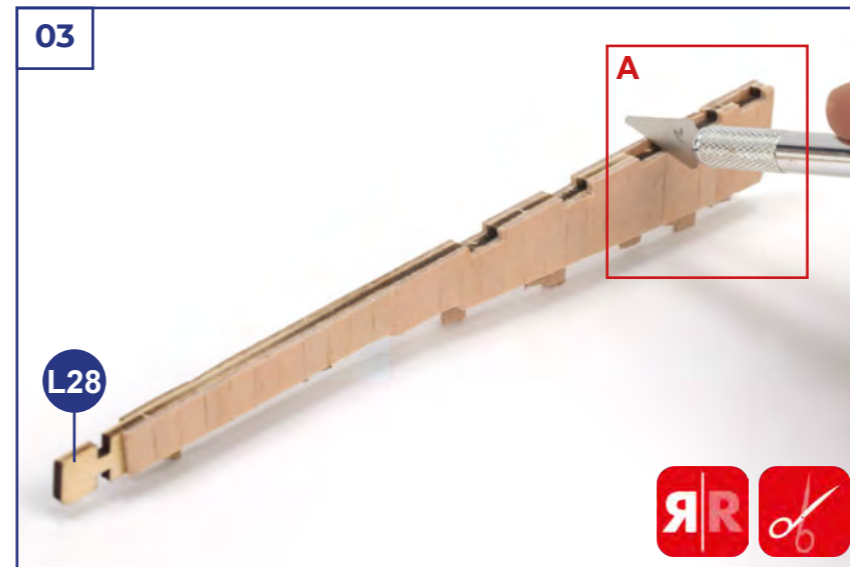
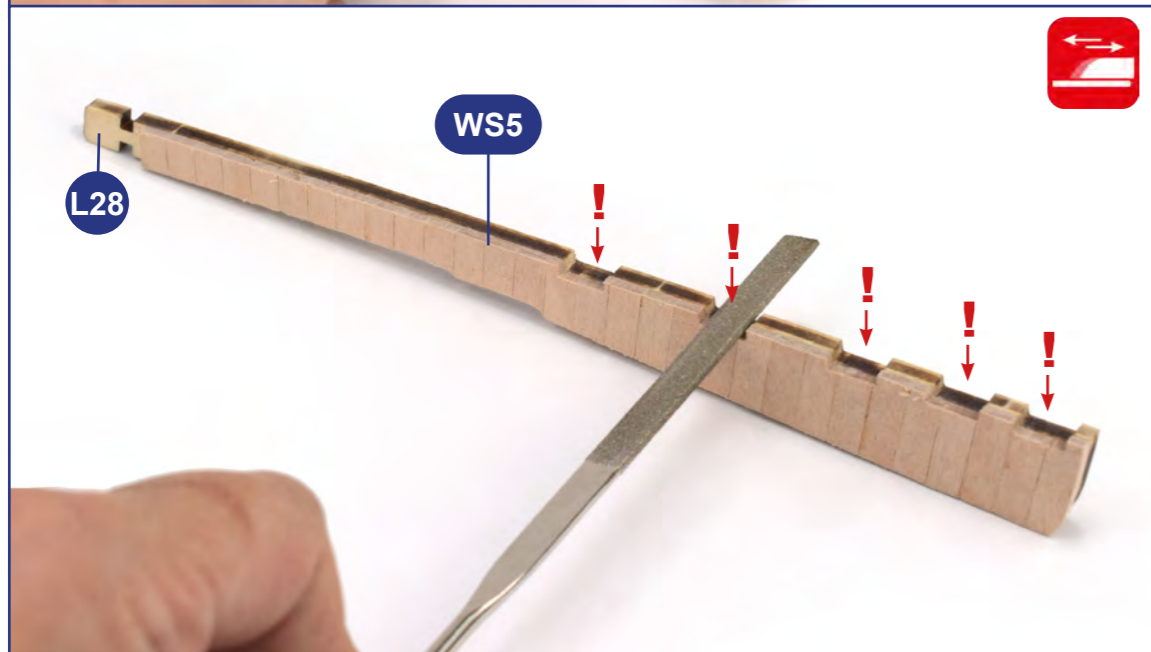

06

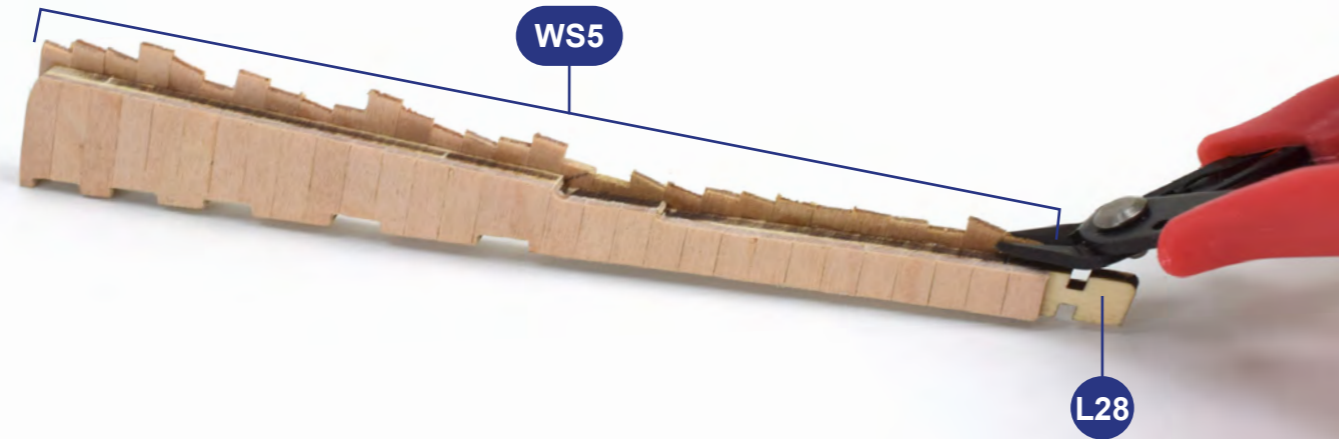

08



07

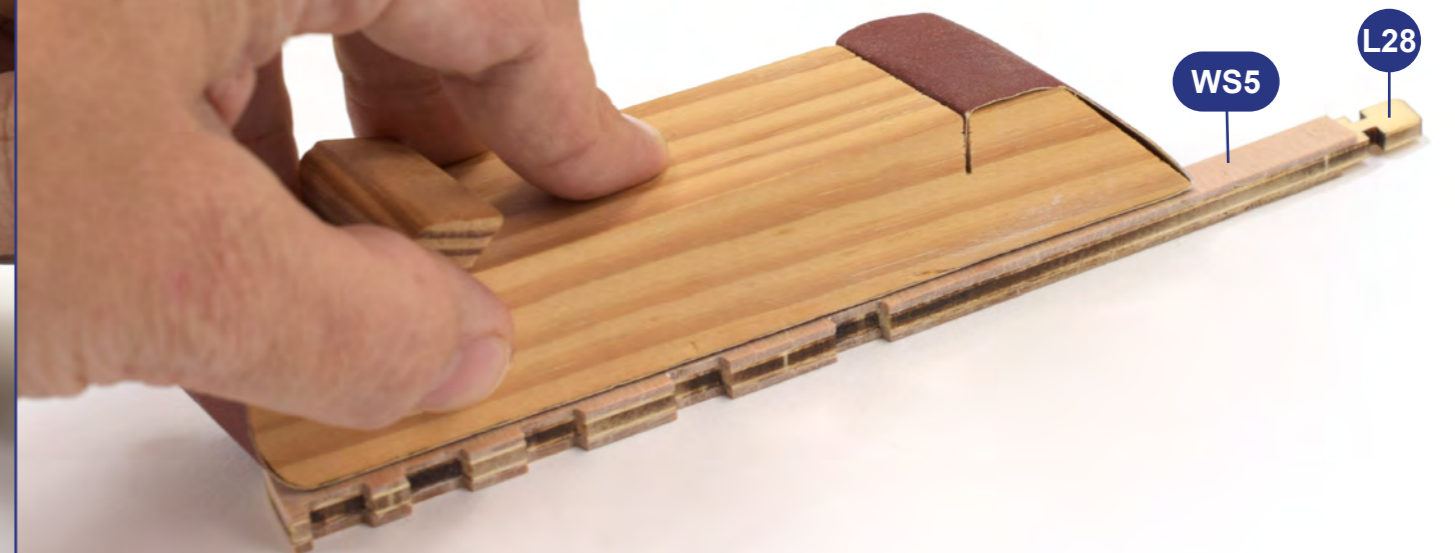
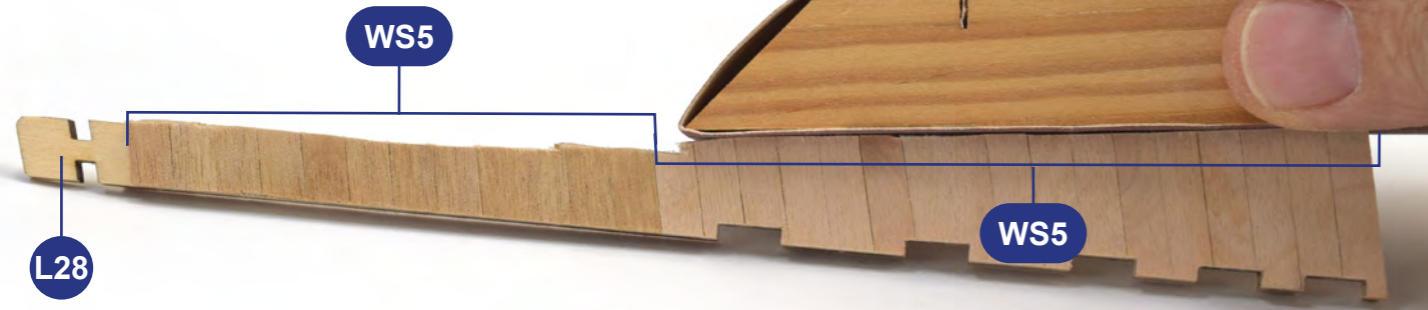

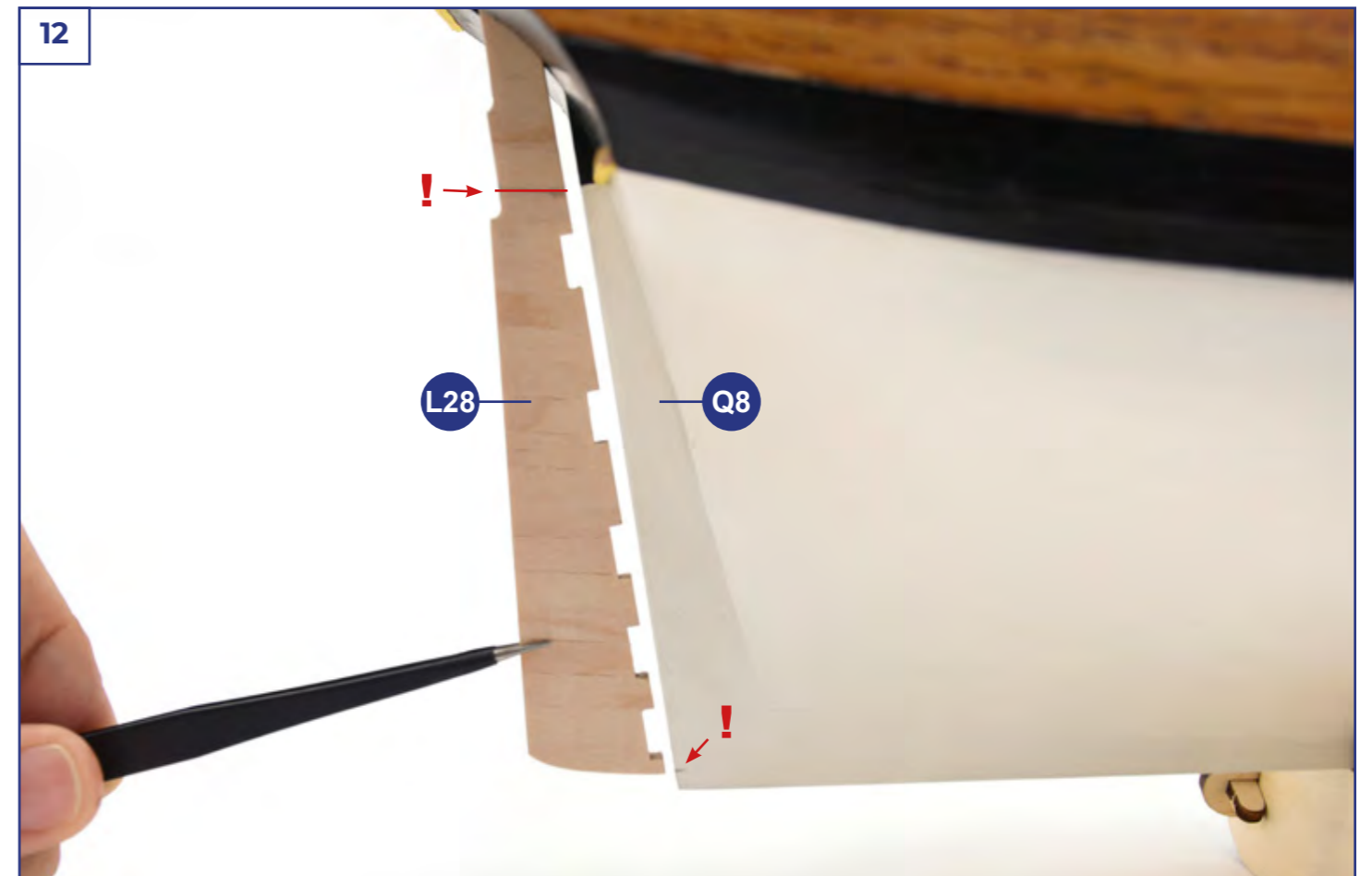
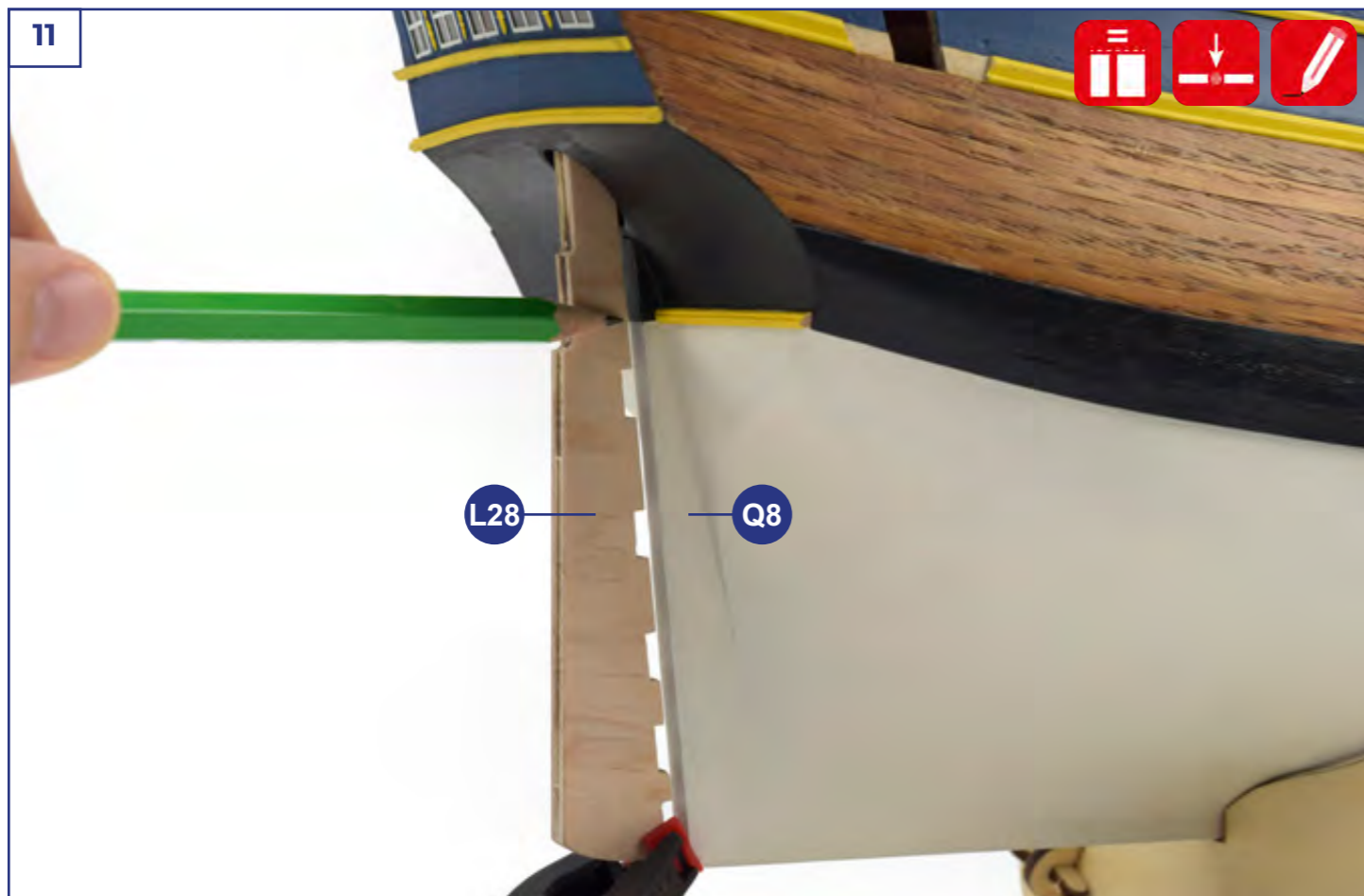

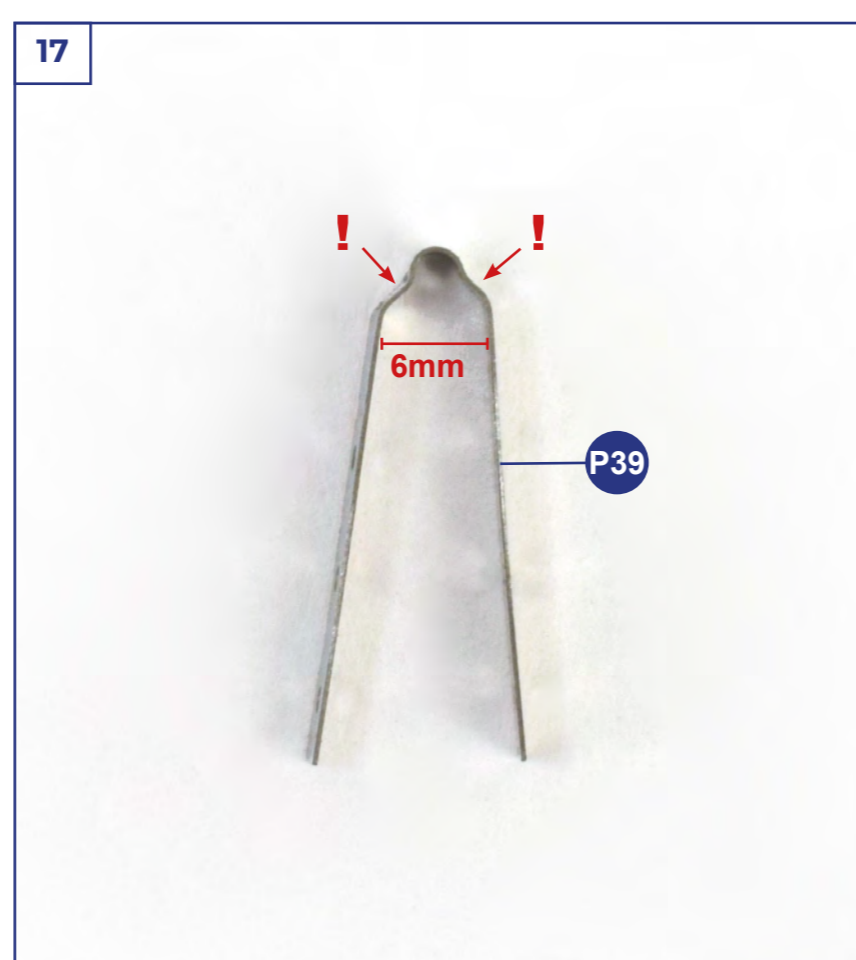
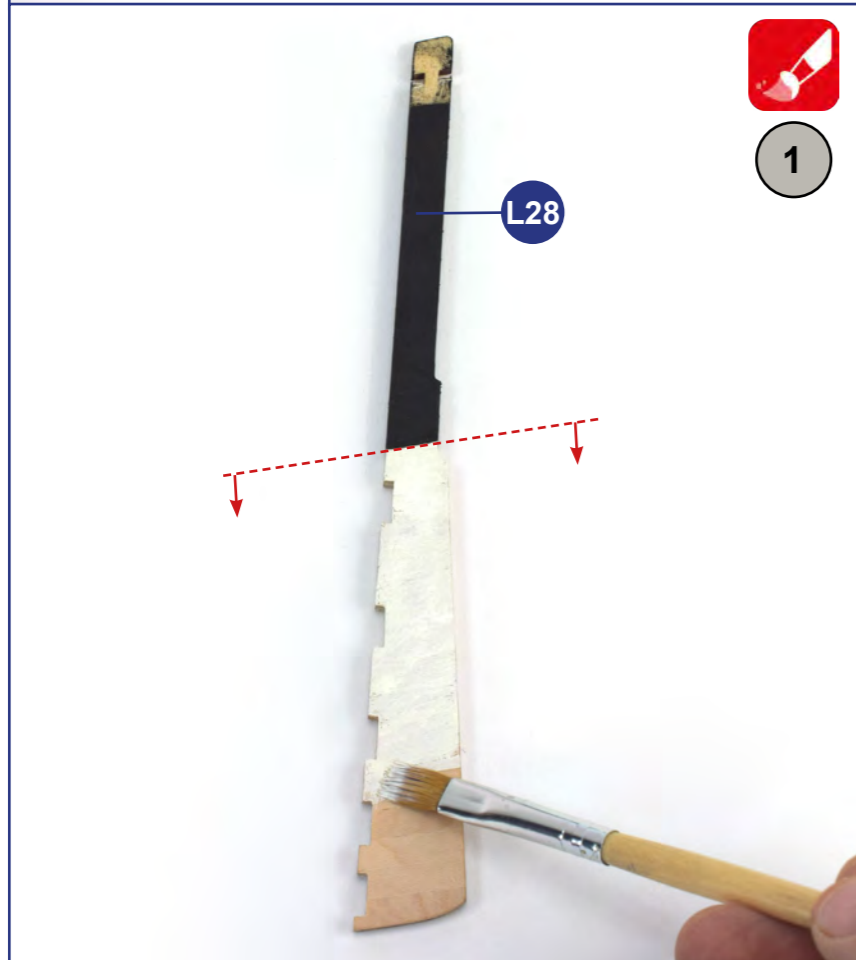
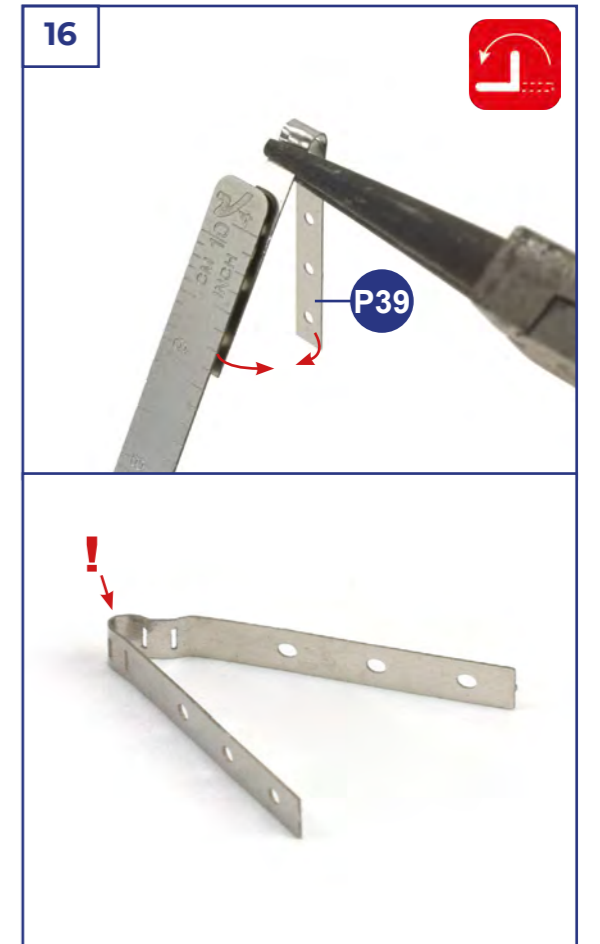
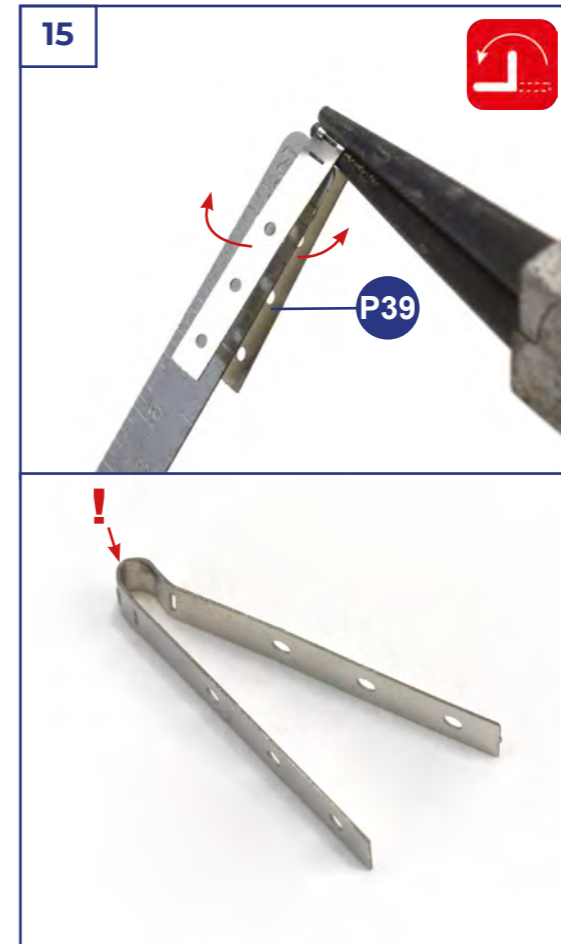
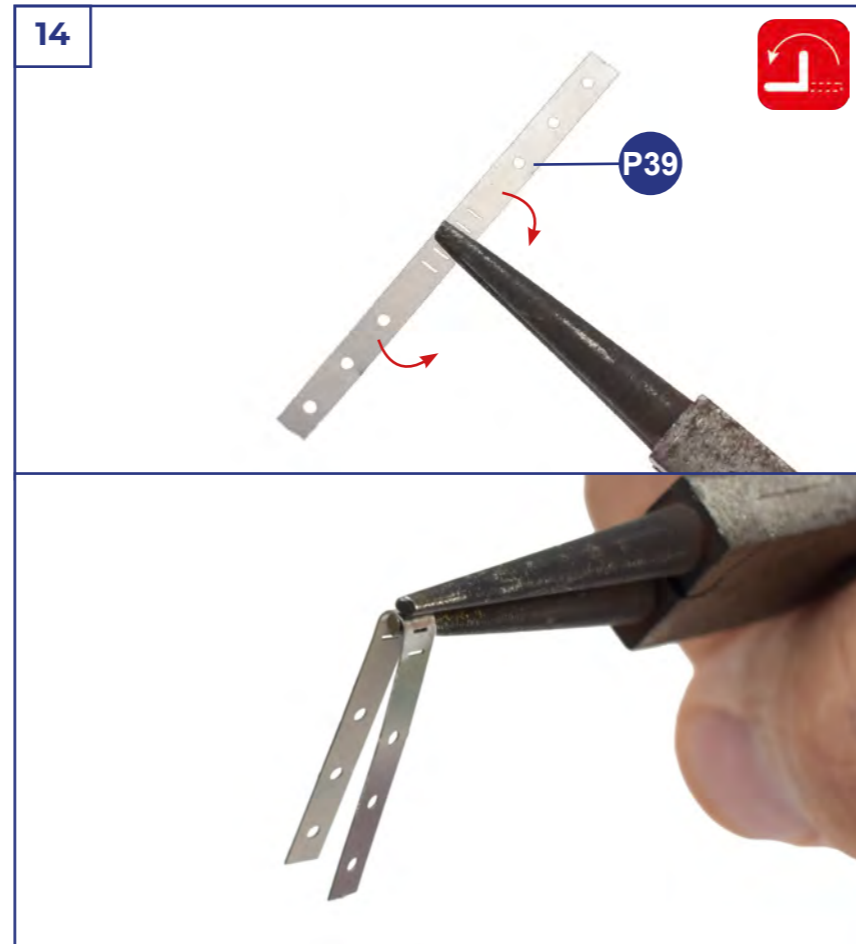
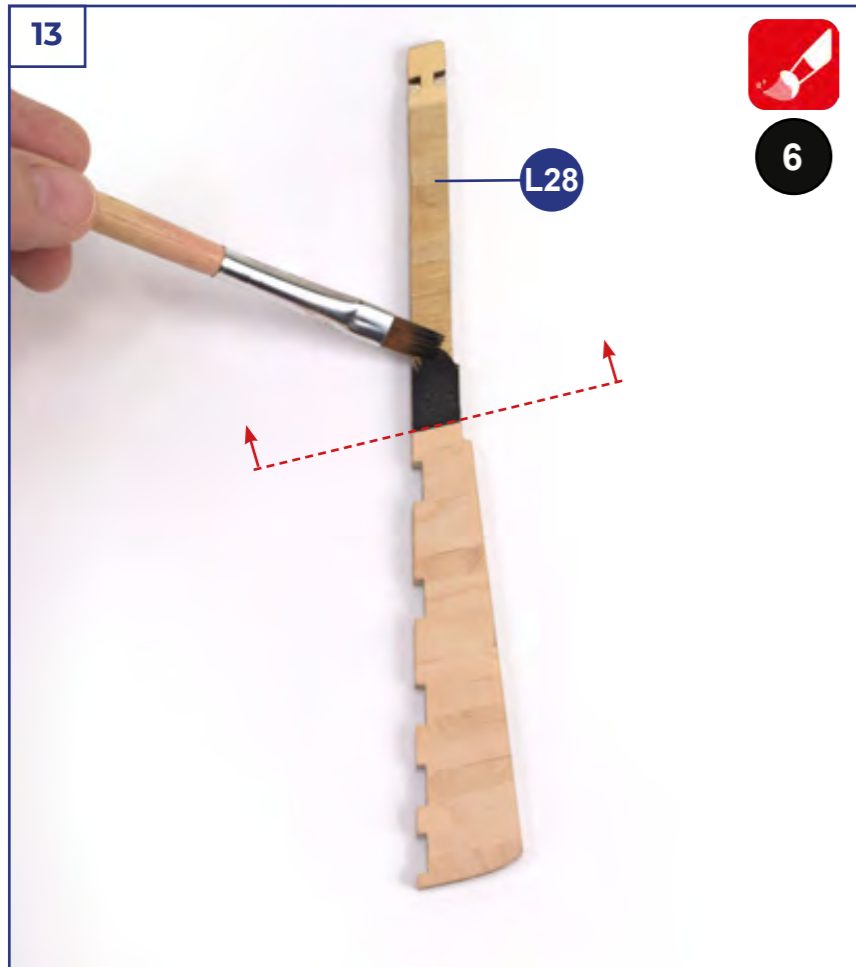

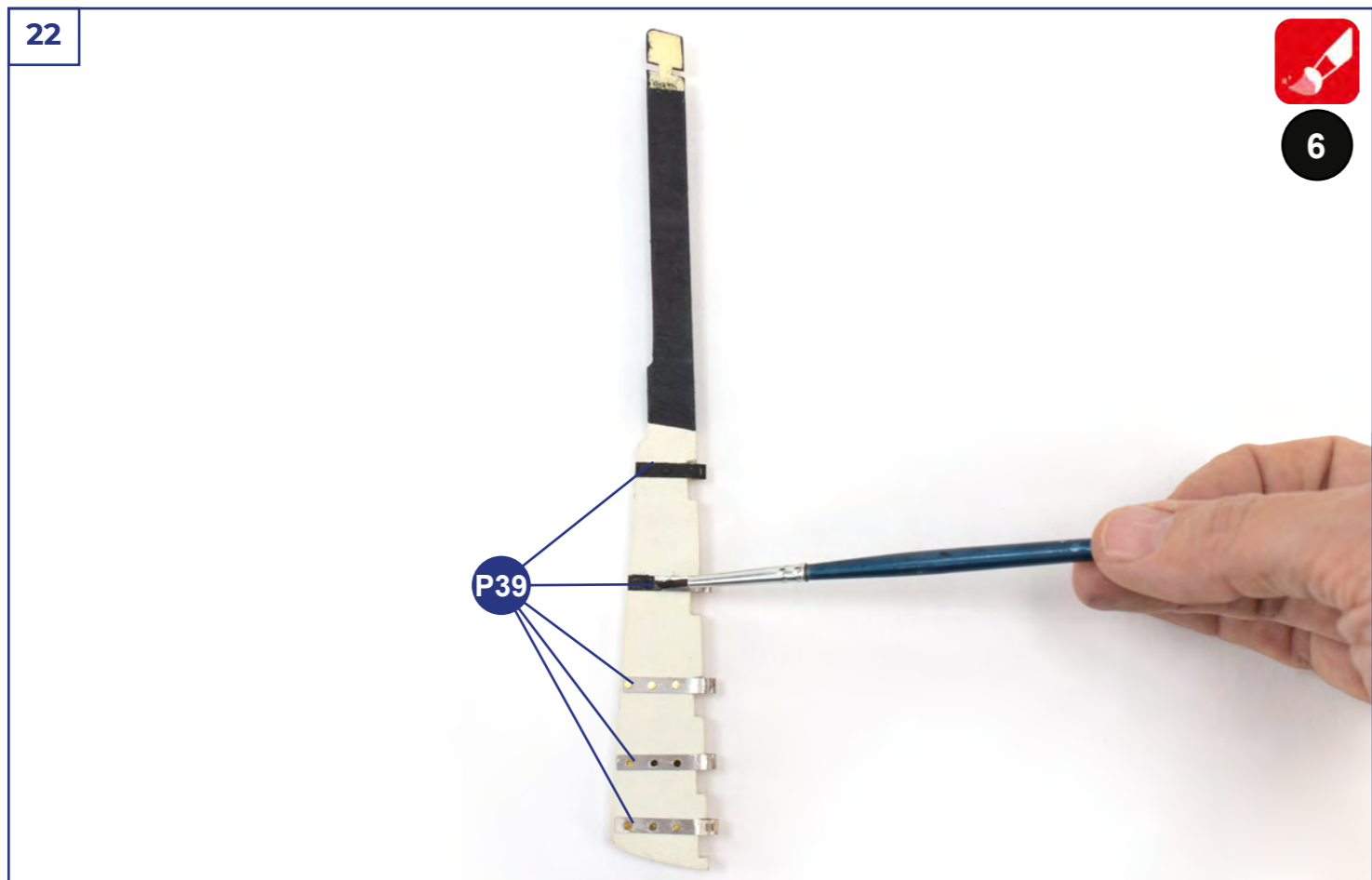
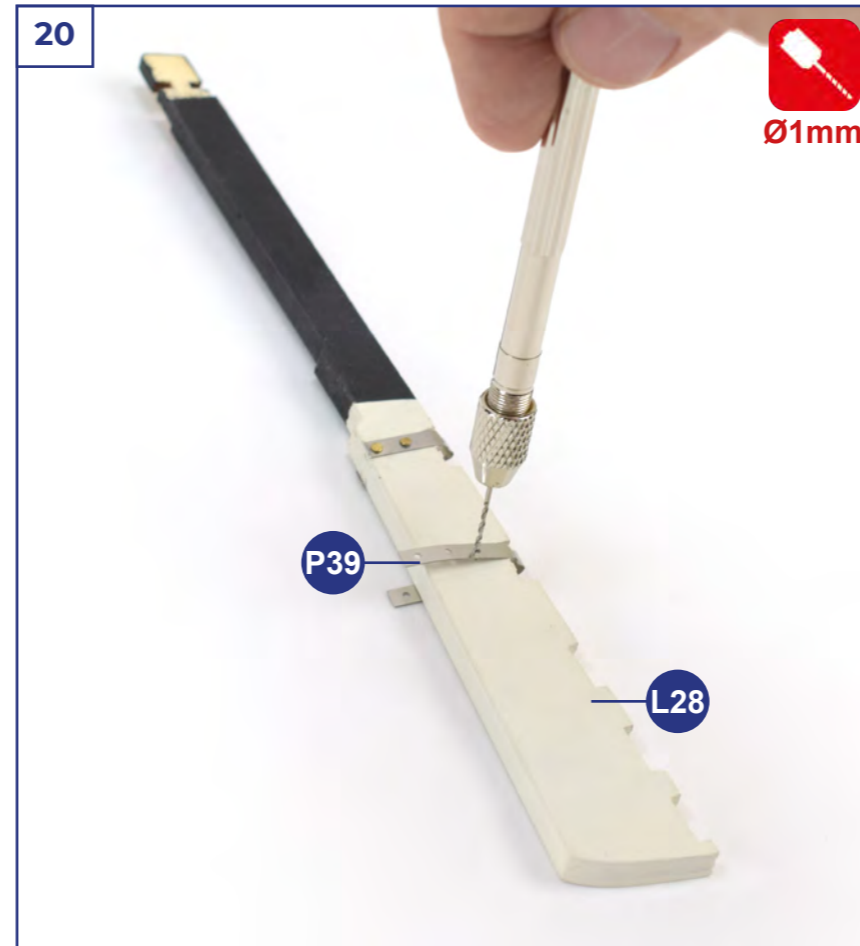
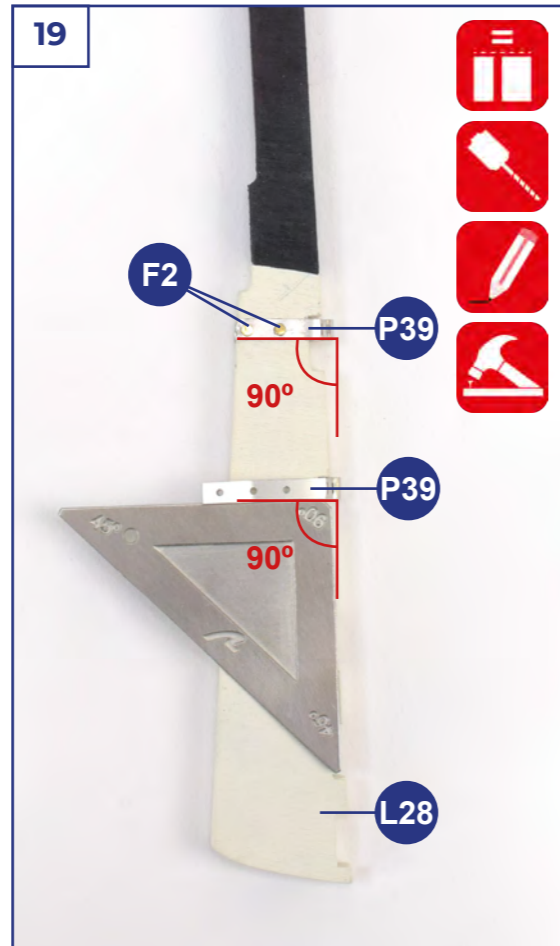
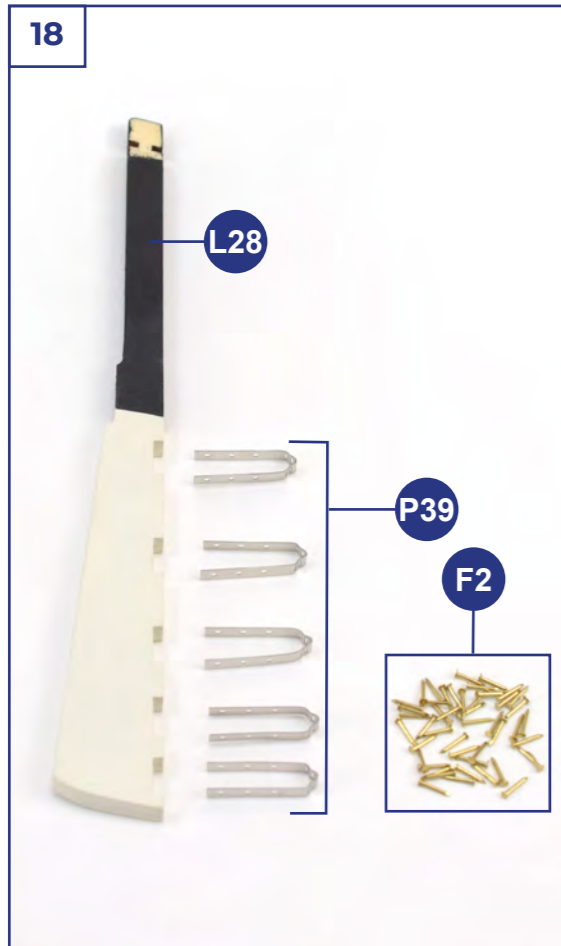

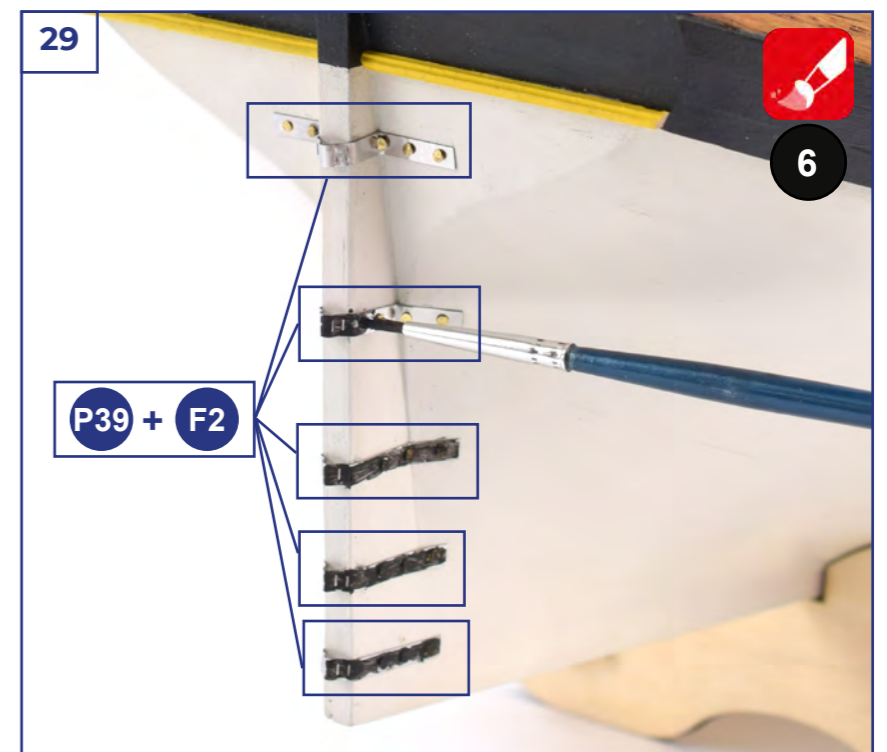
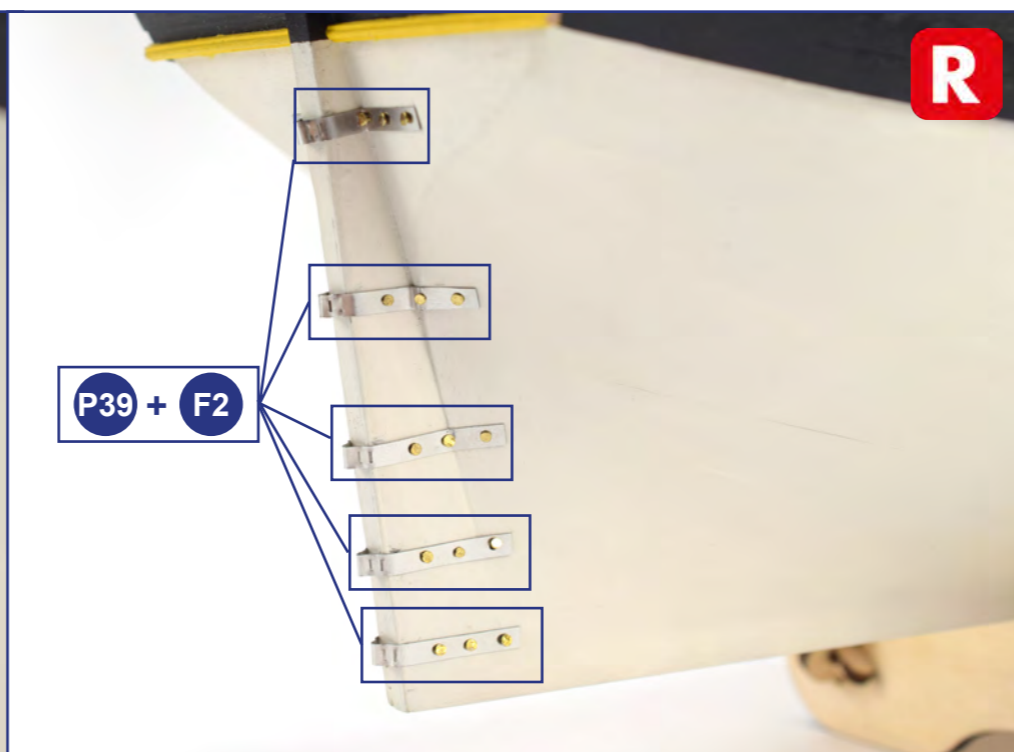
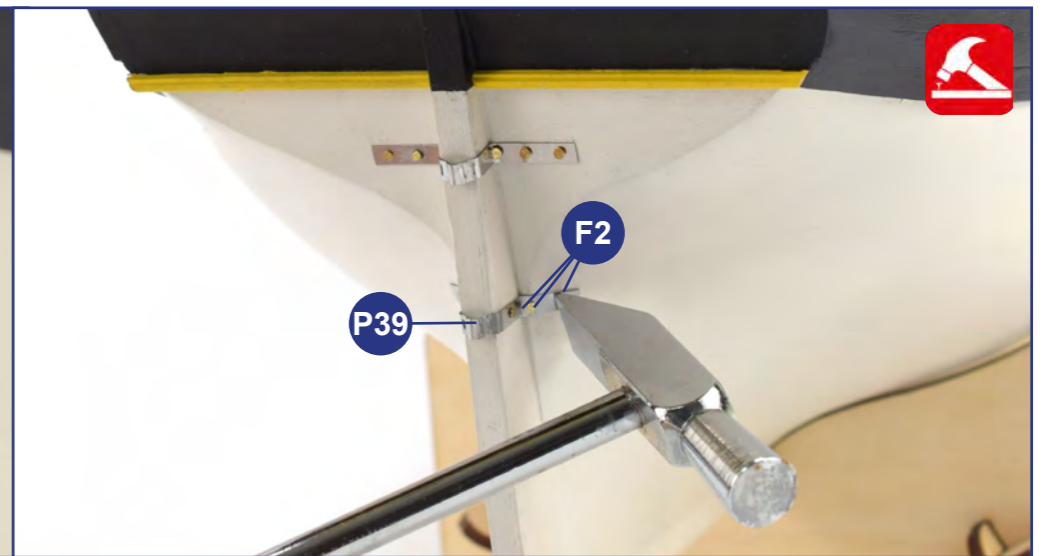
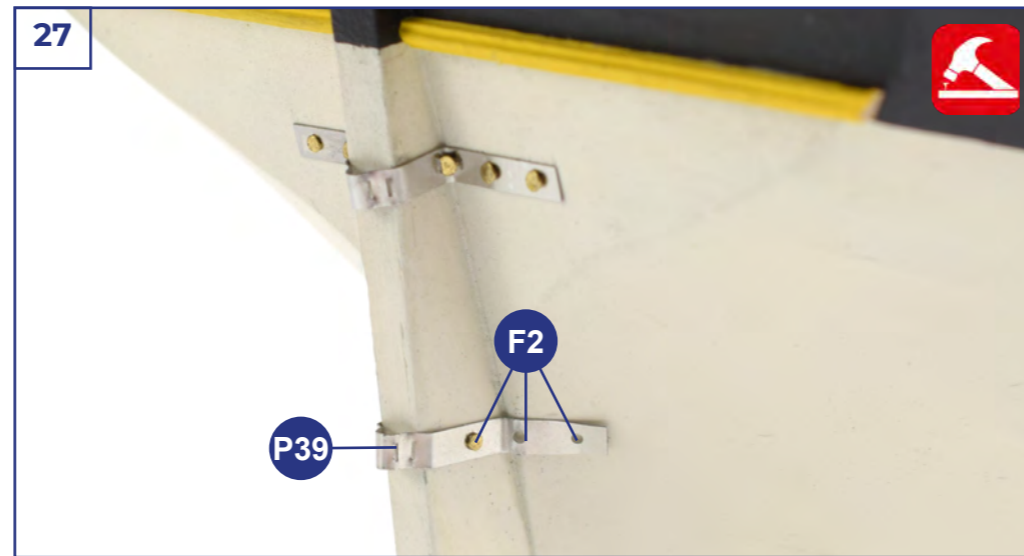
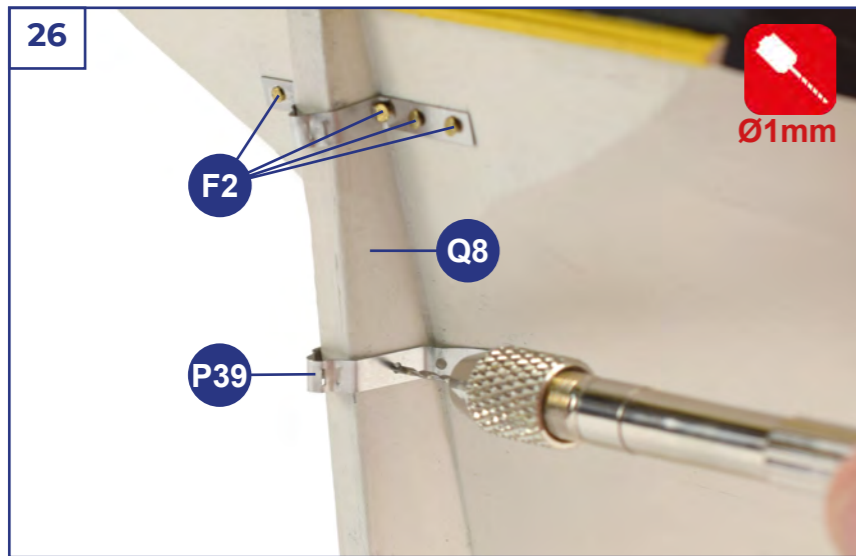
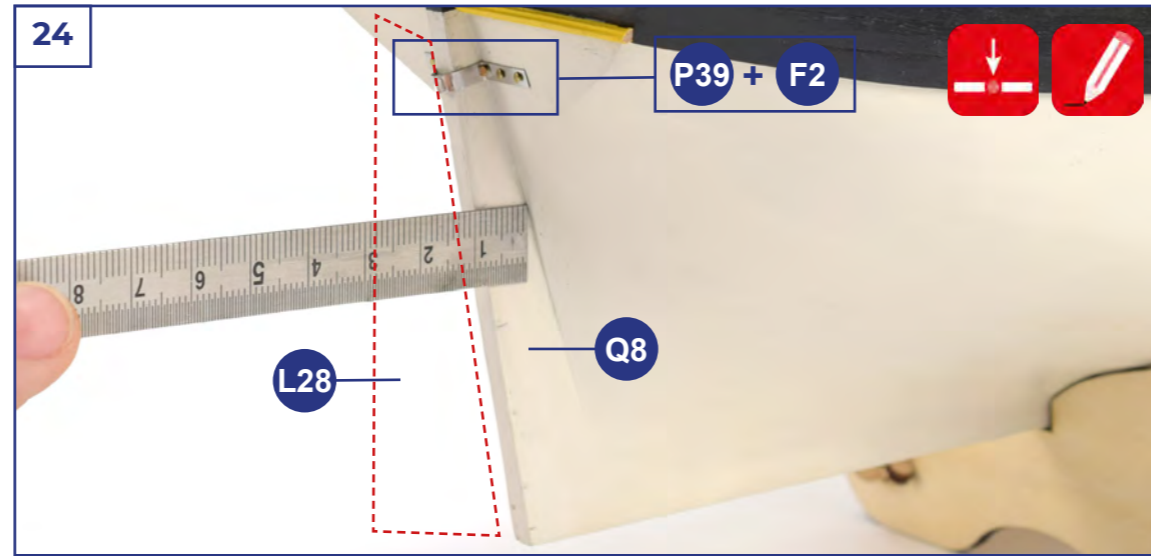

30

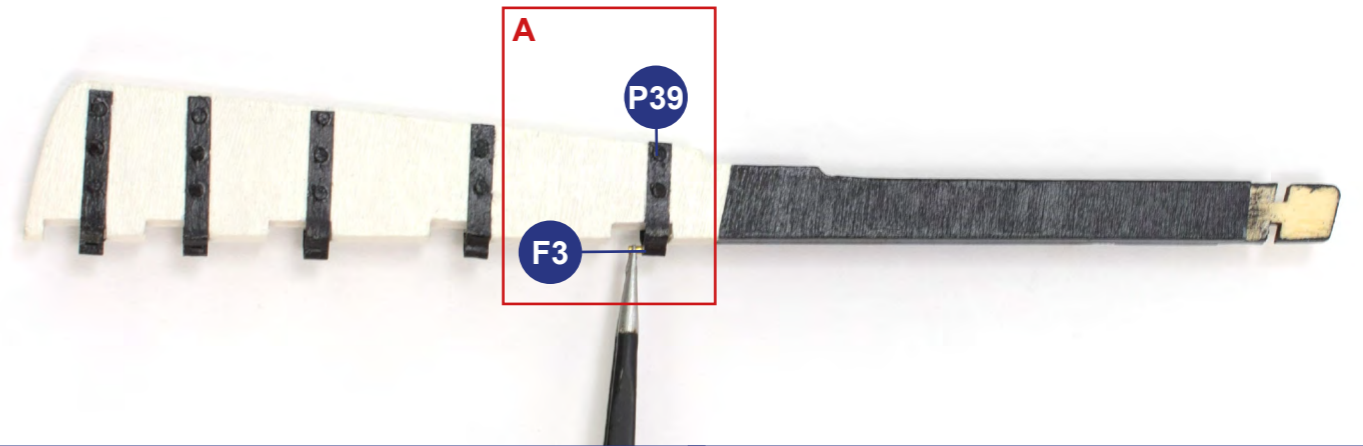
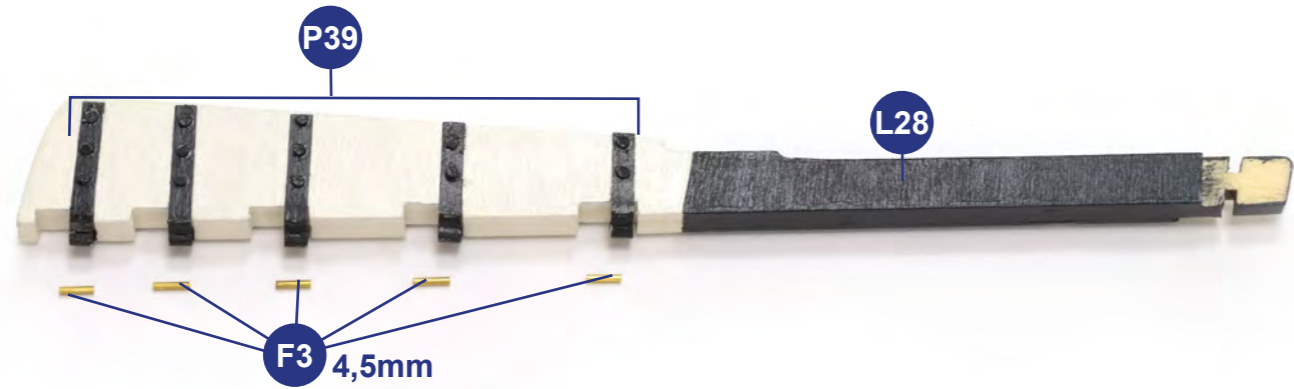

A

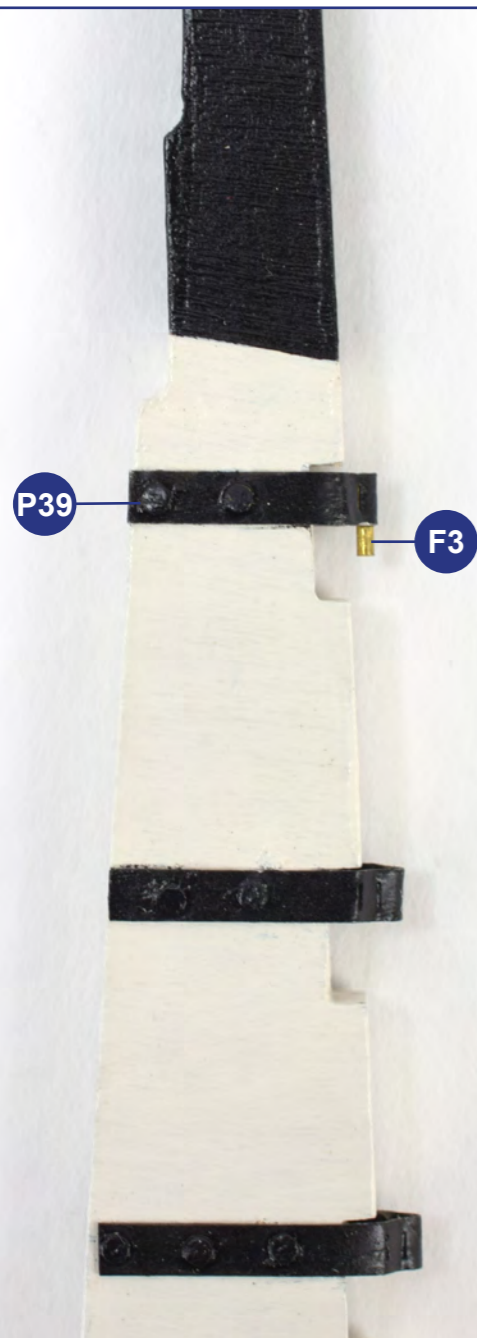

R

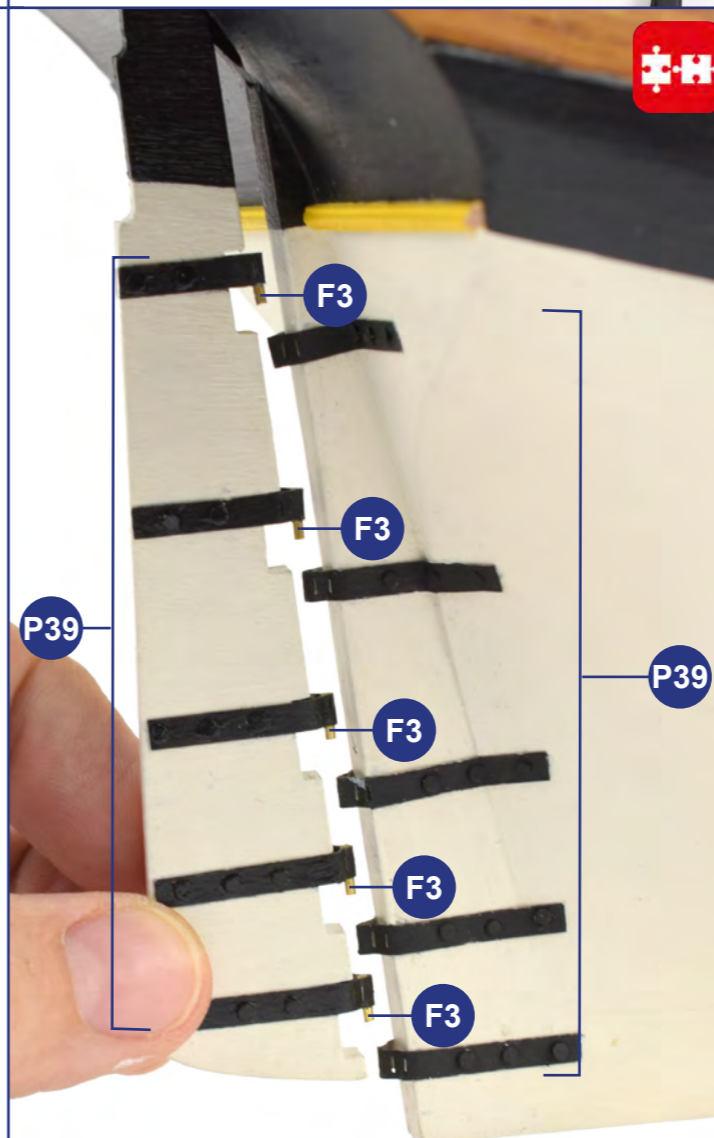
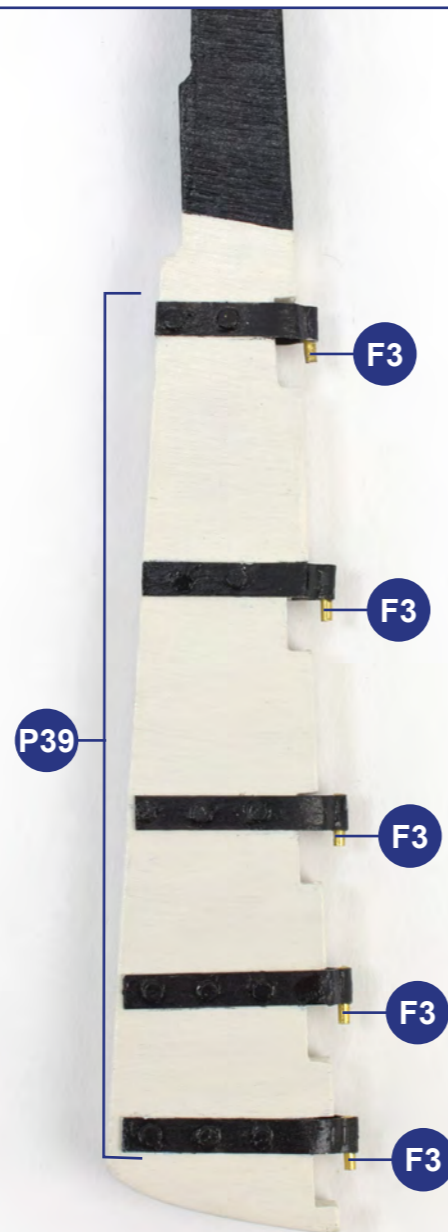

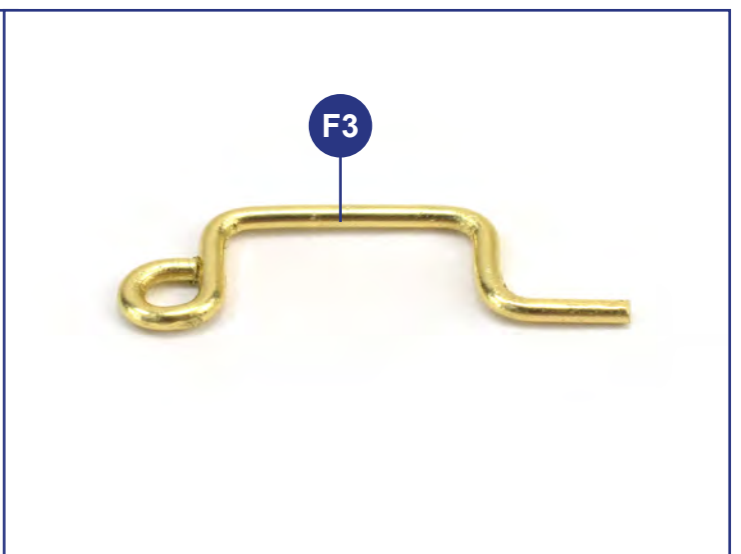
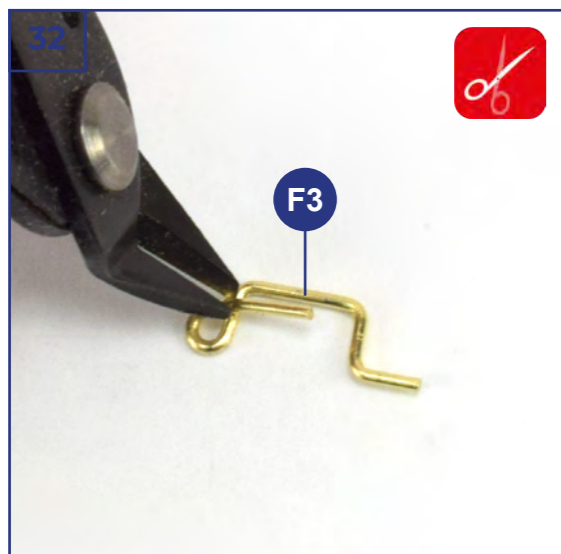
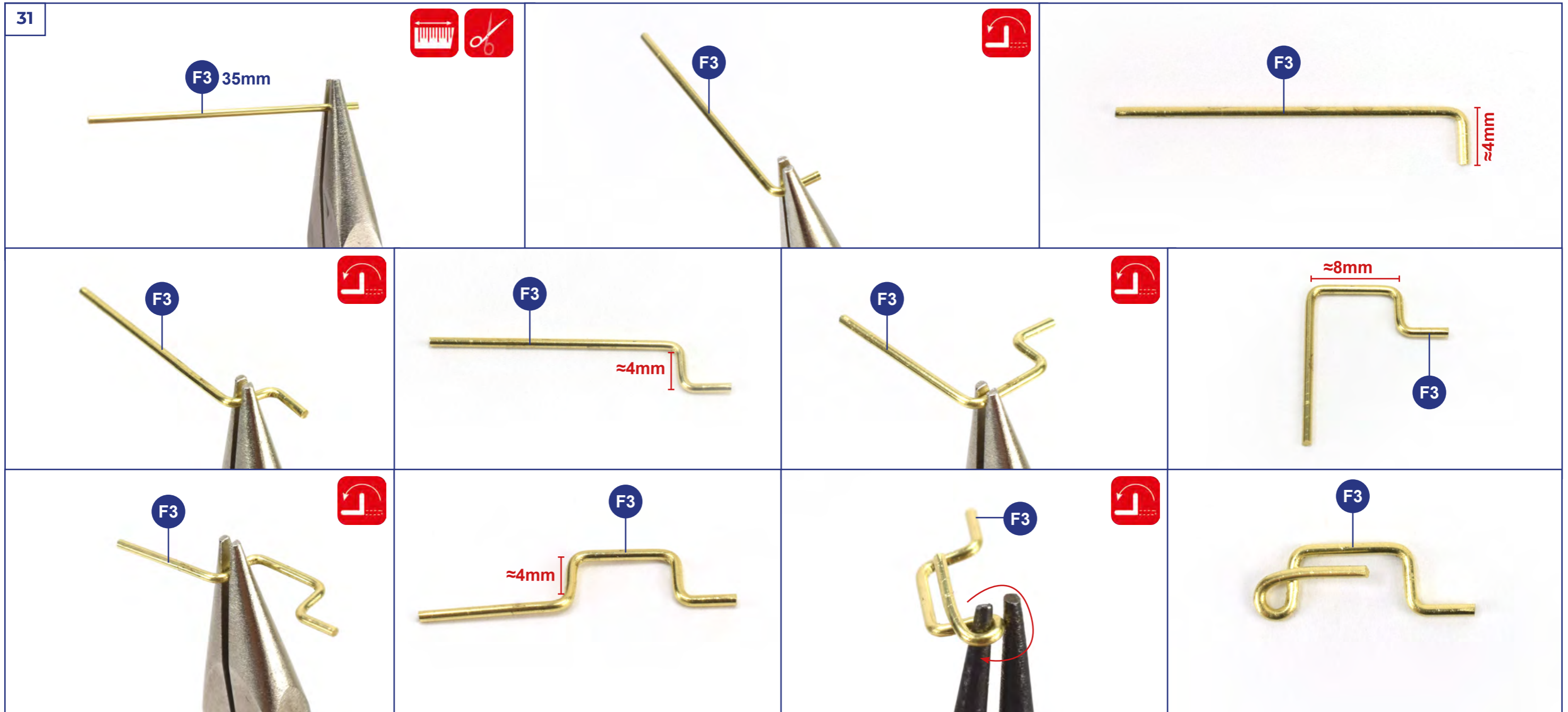

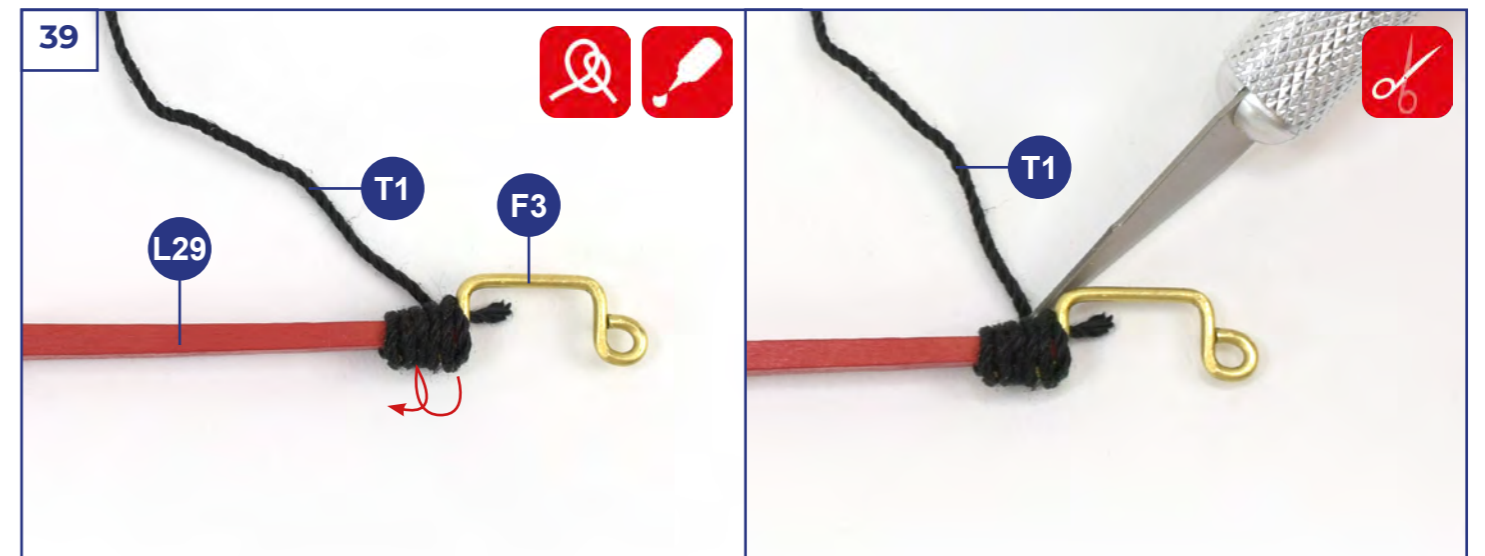
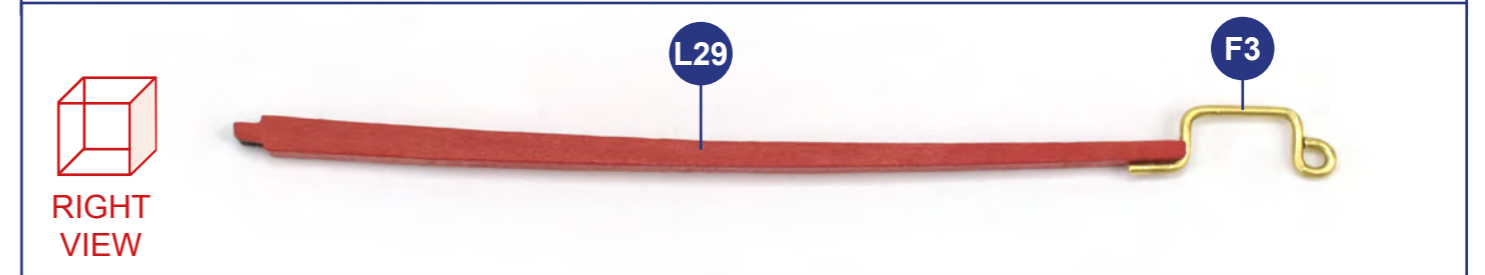
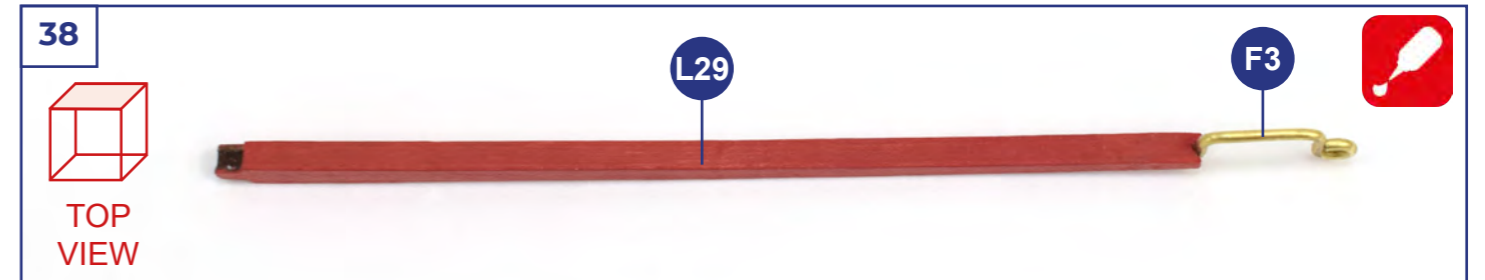
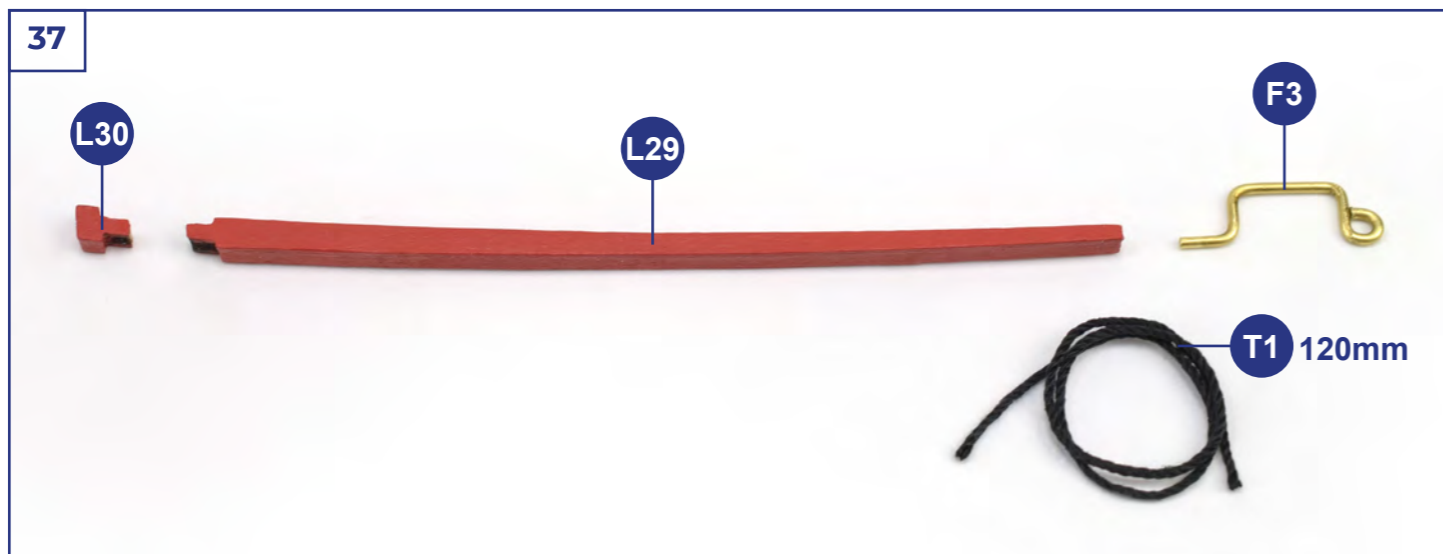
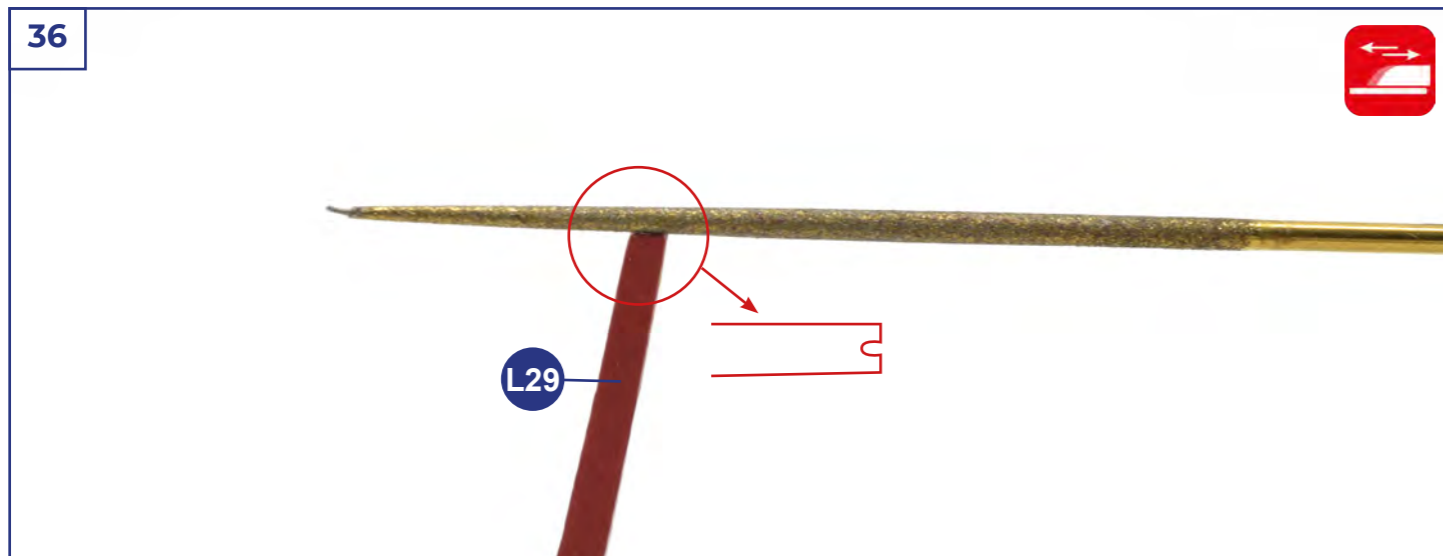
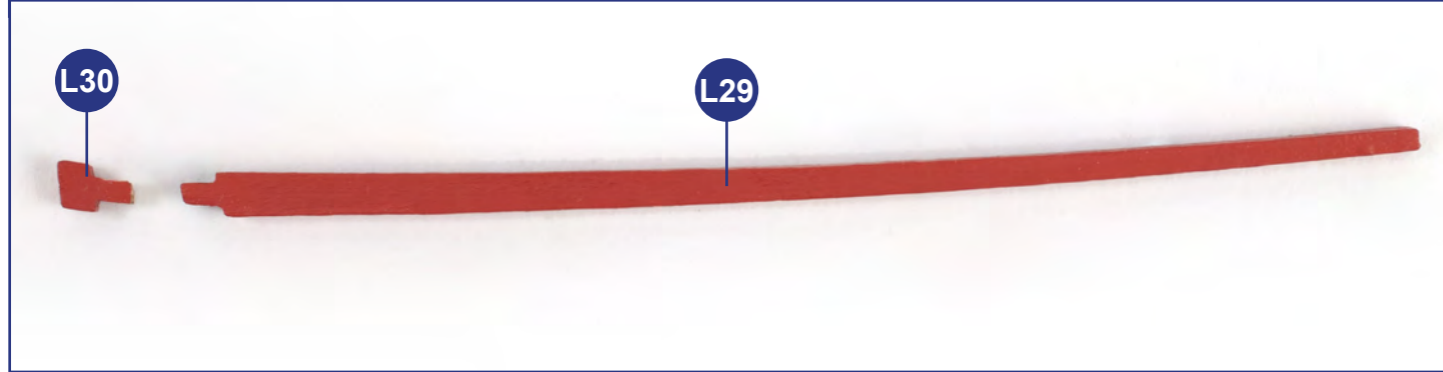
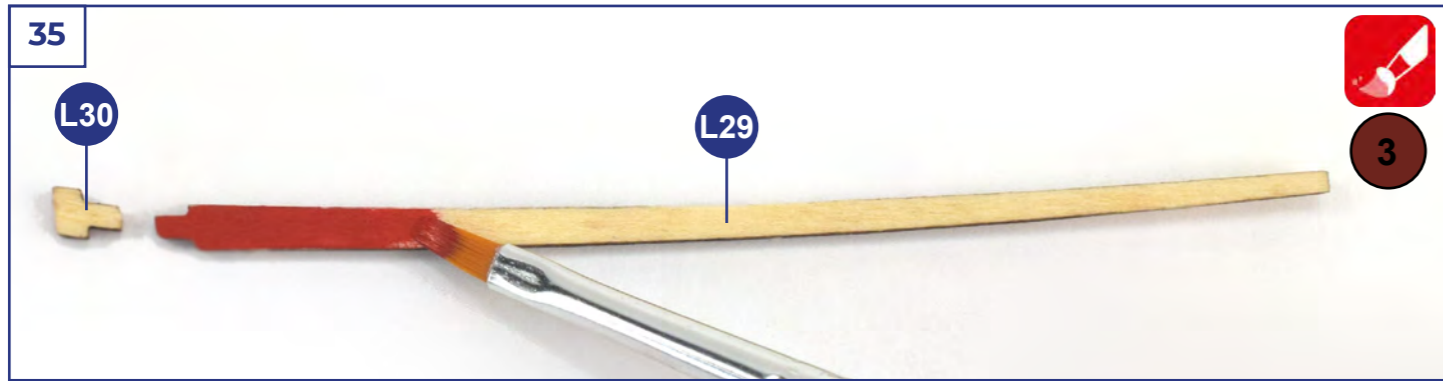

40

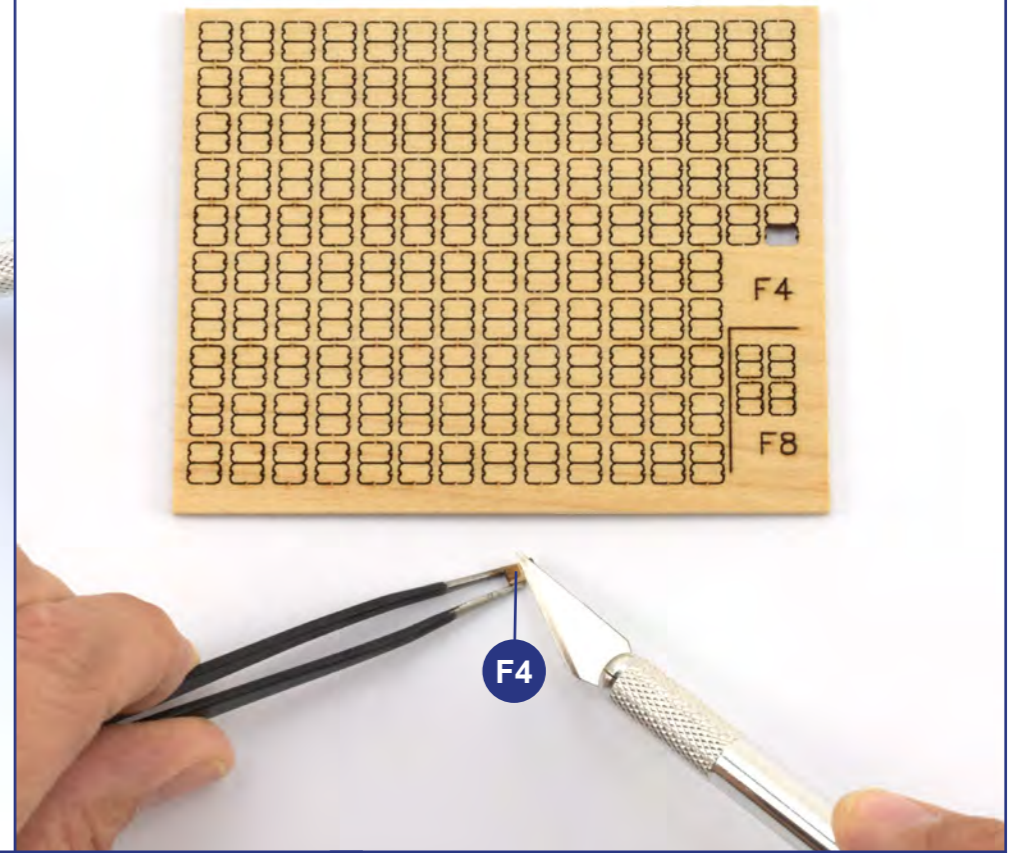
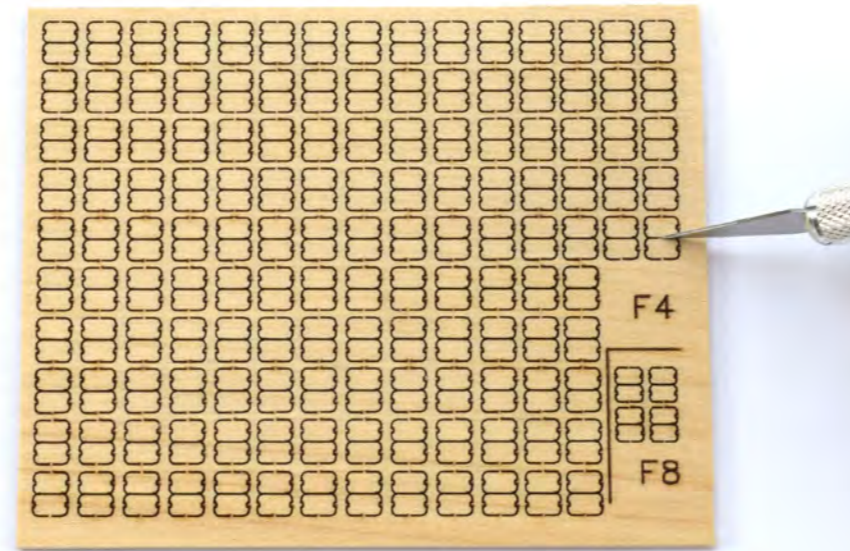
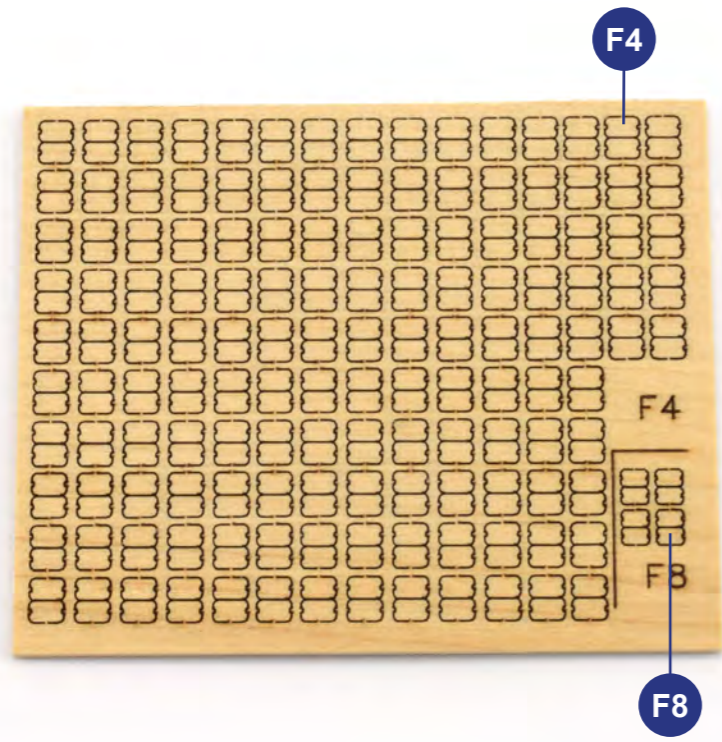

Ø0,8mm

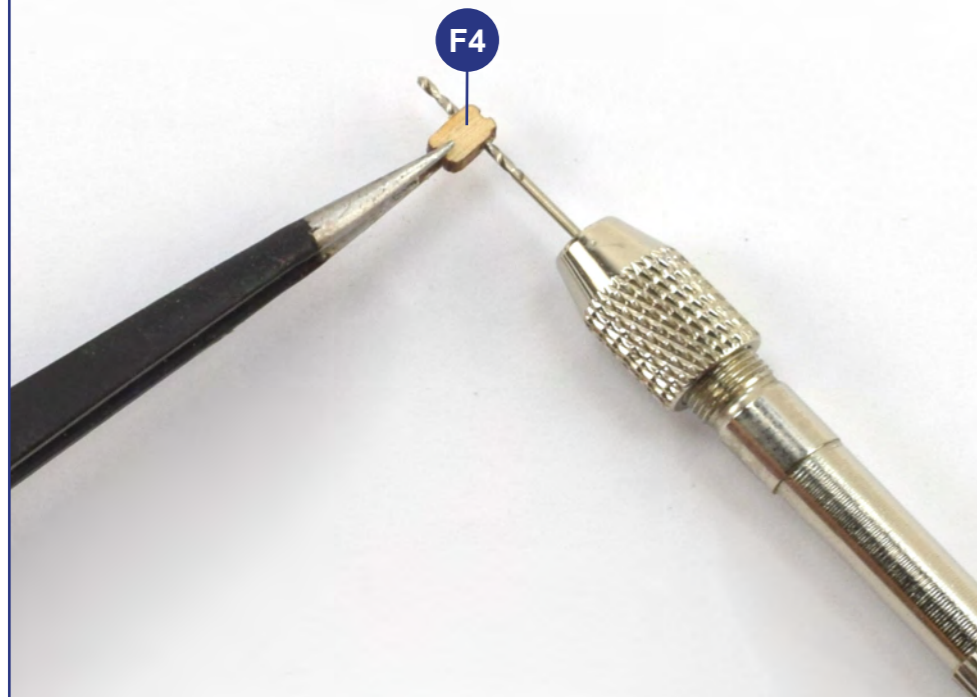

x280

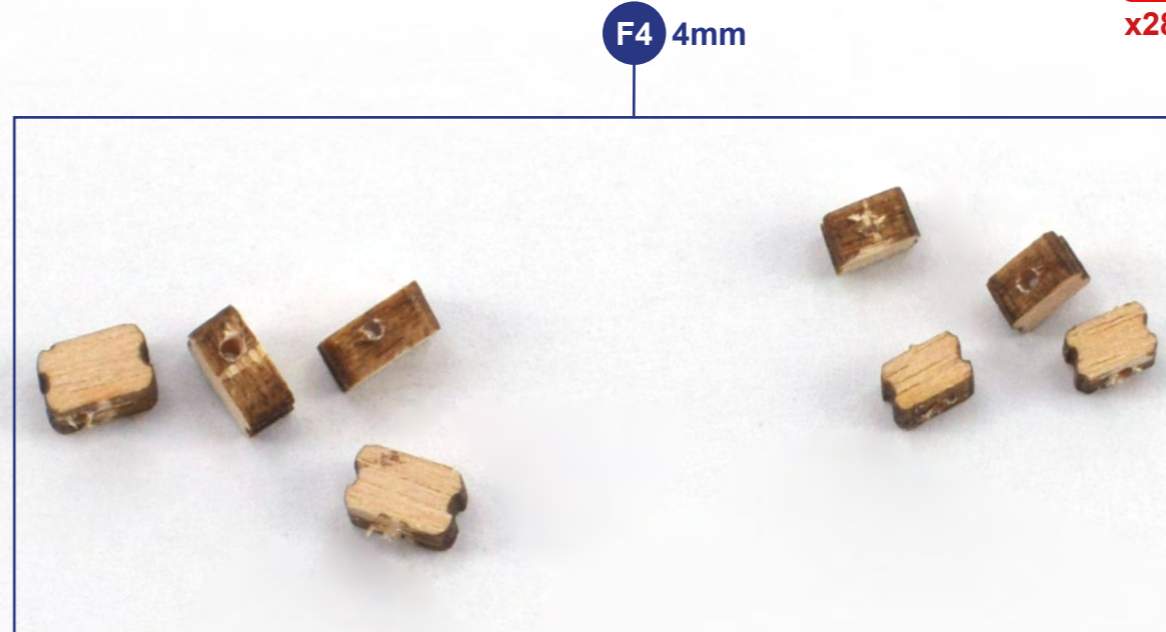

x8



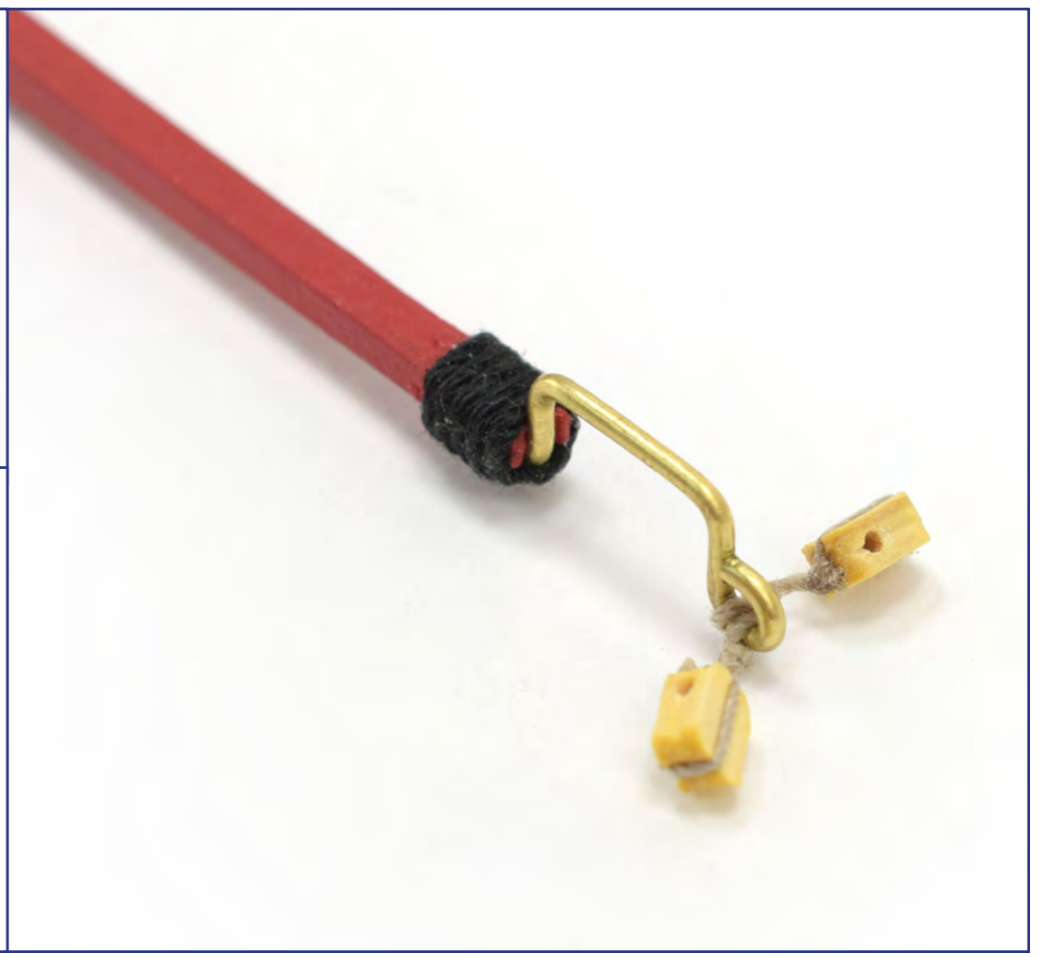
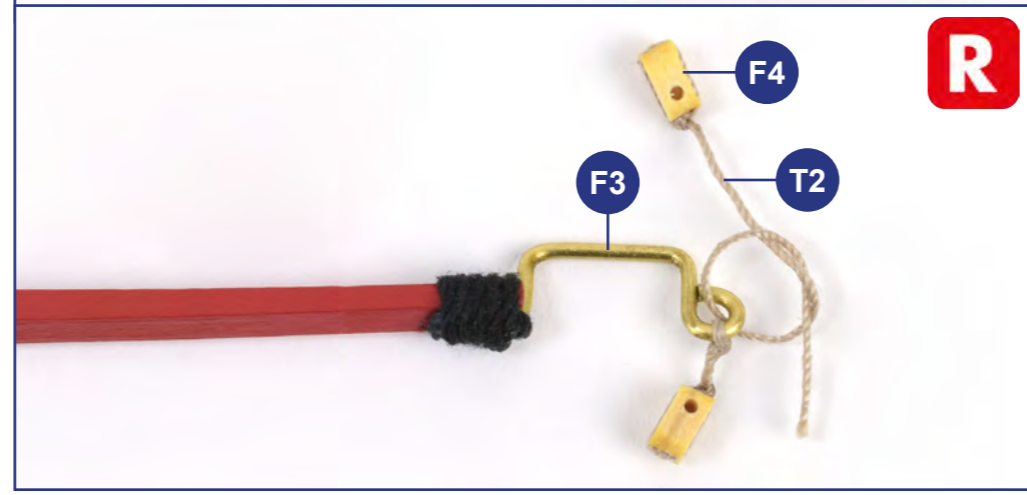
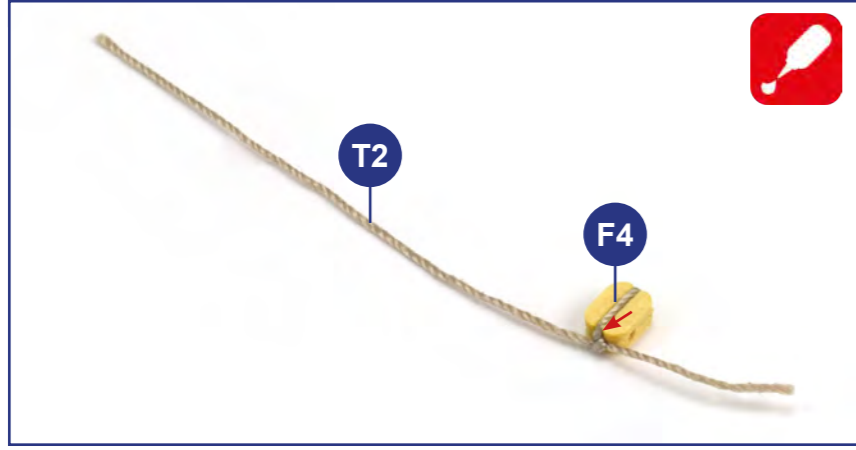
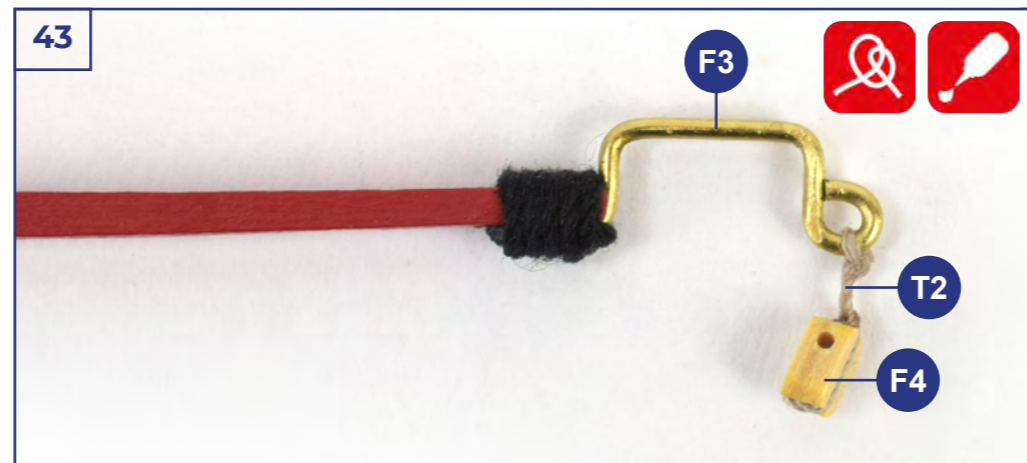
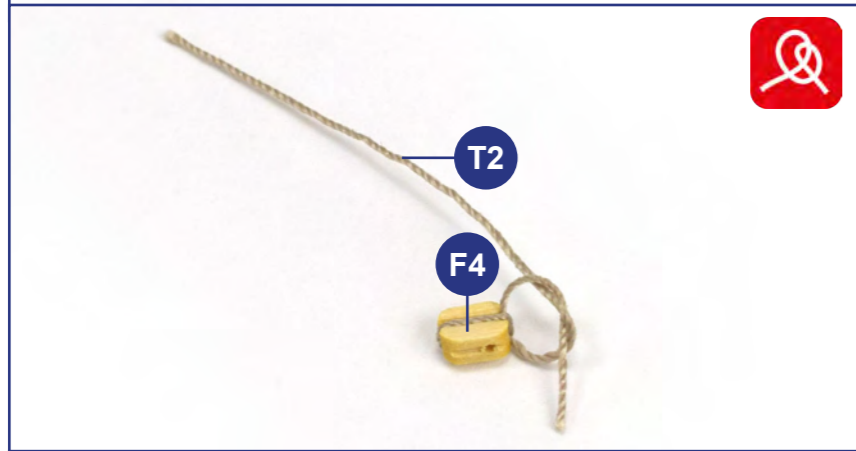
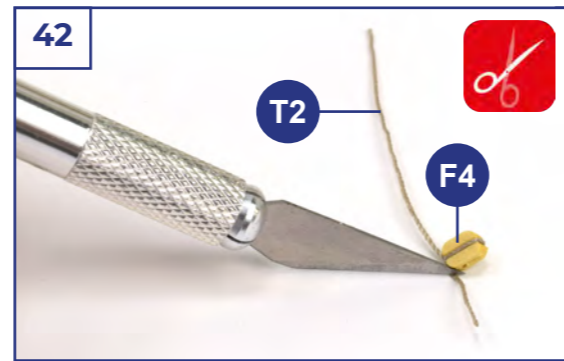
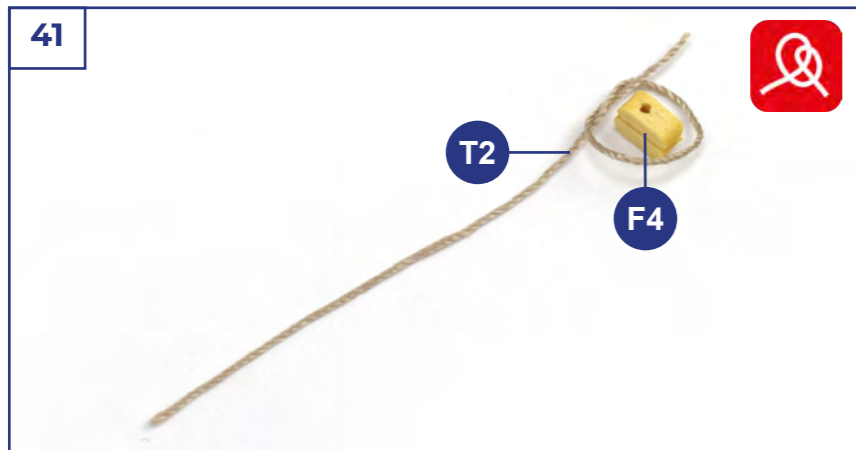
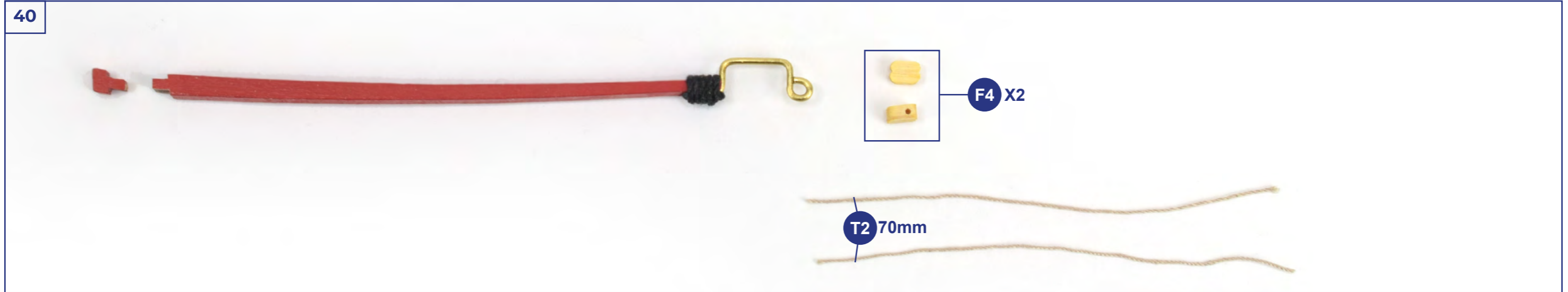

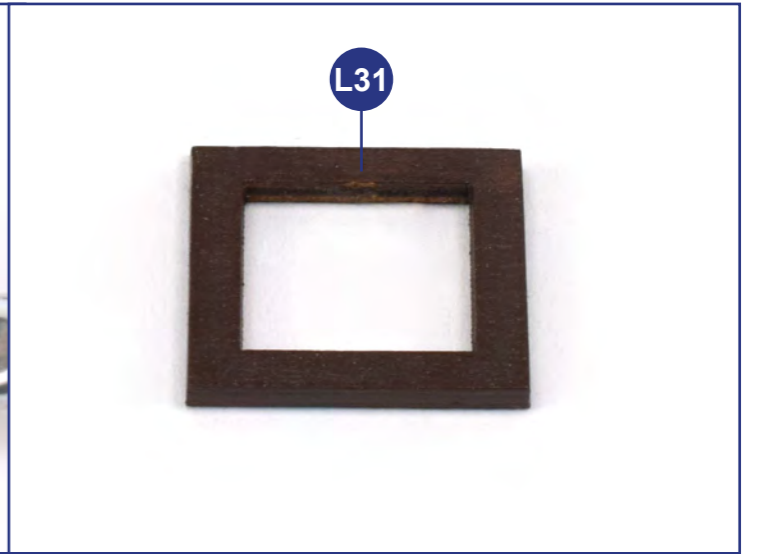
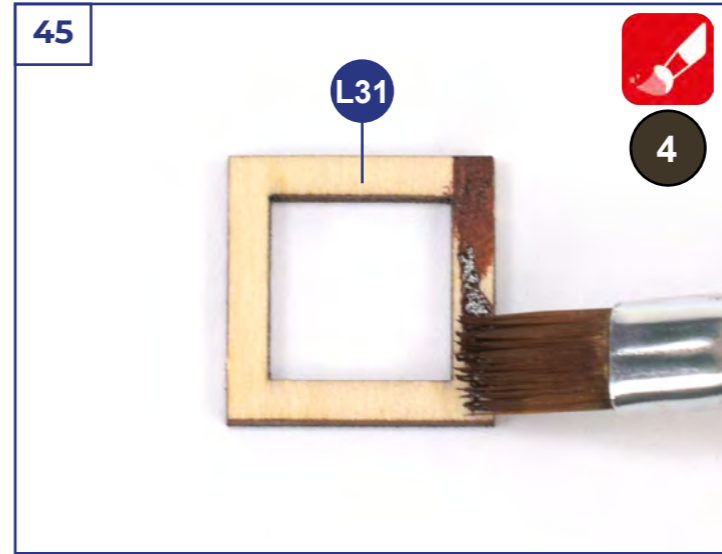
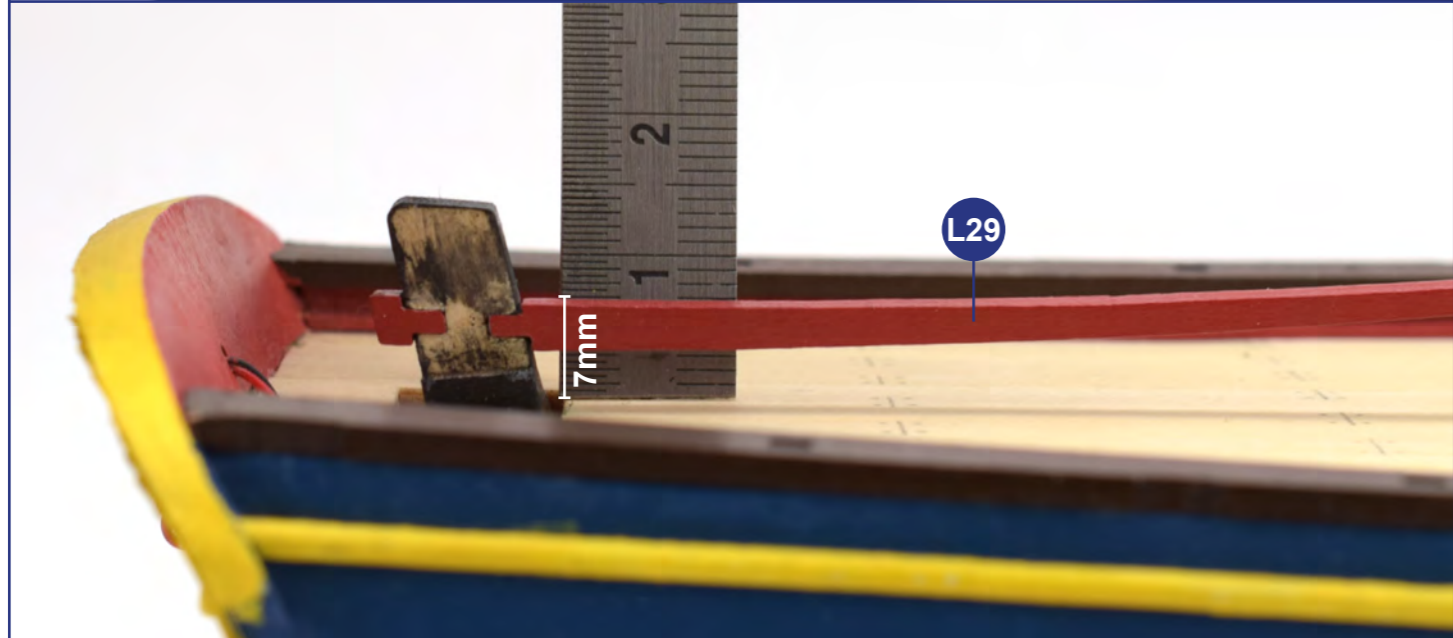
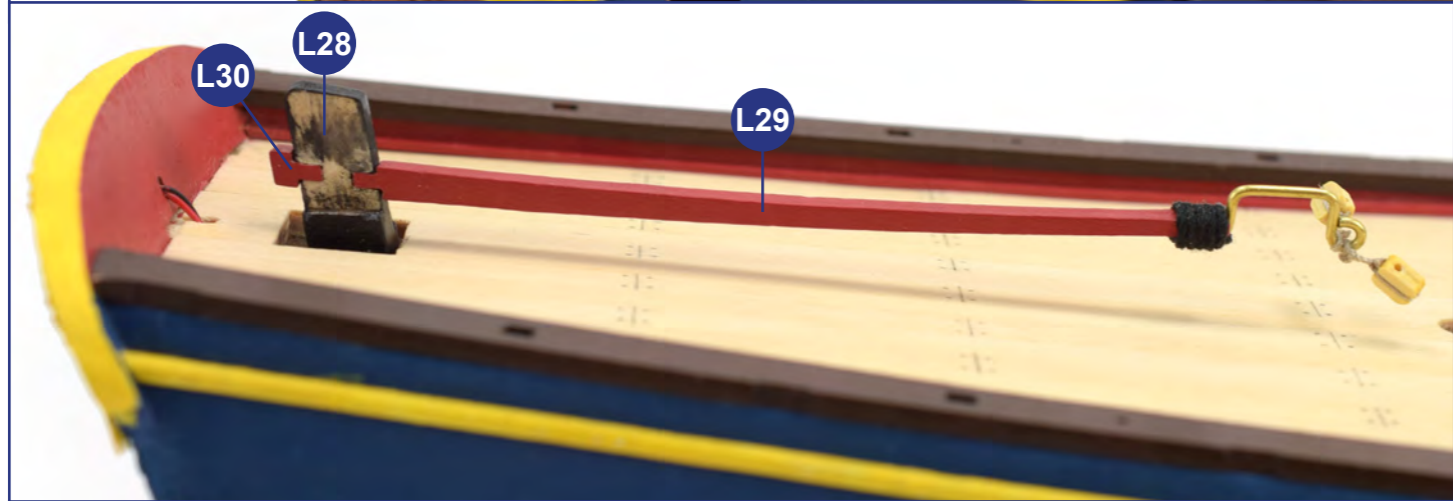
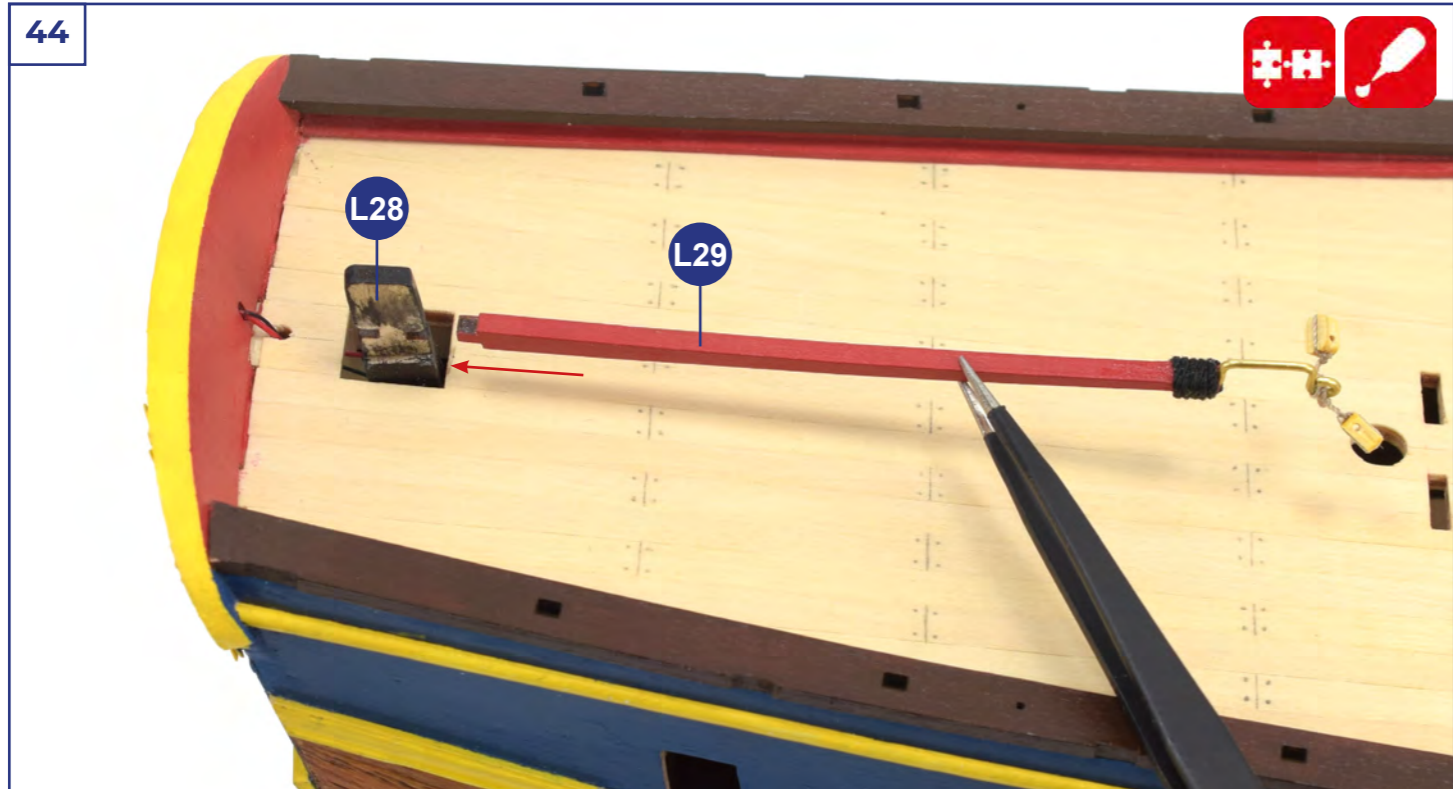

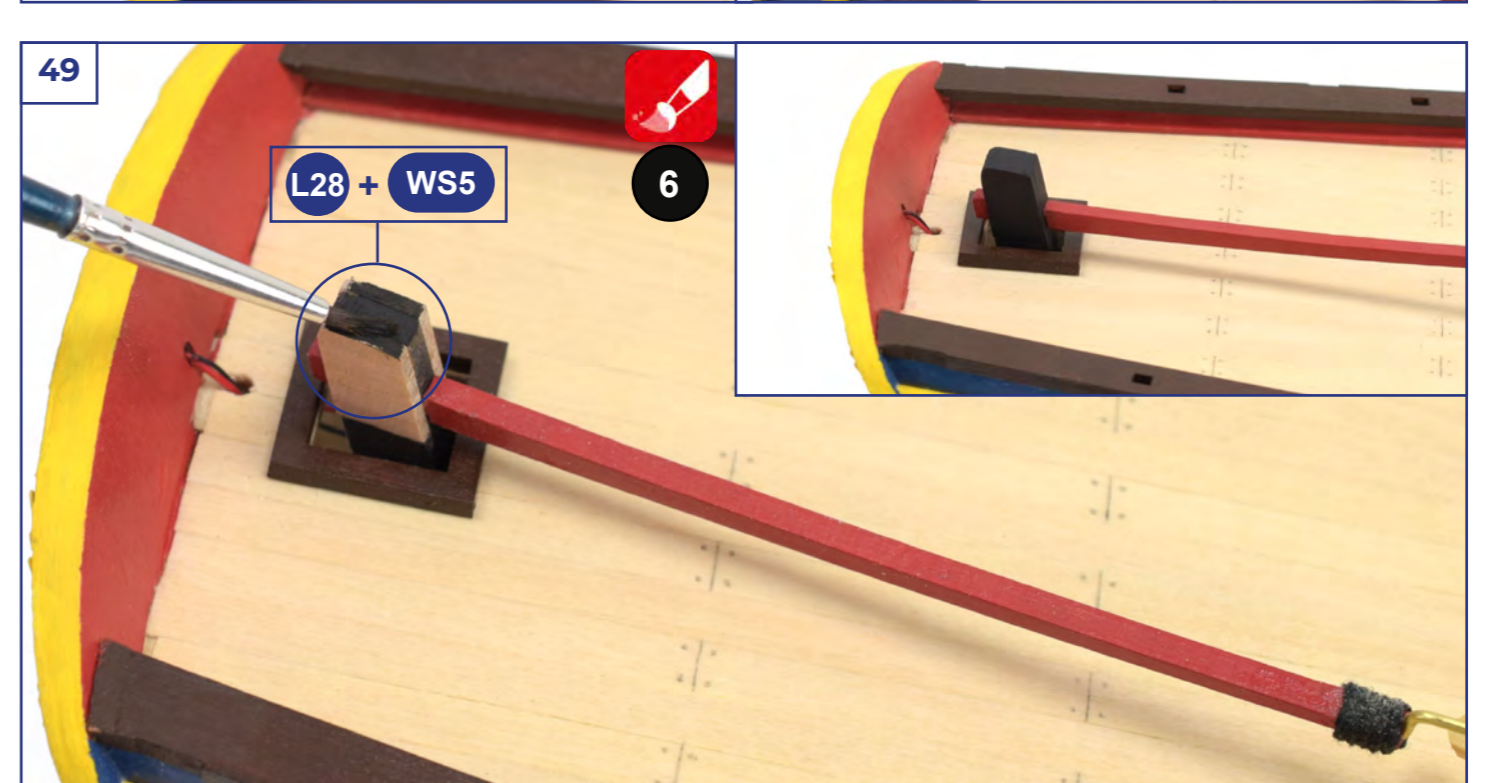
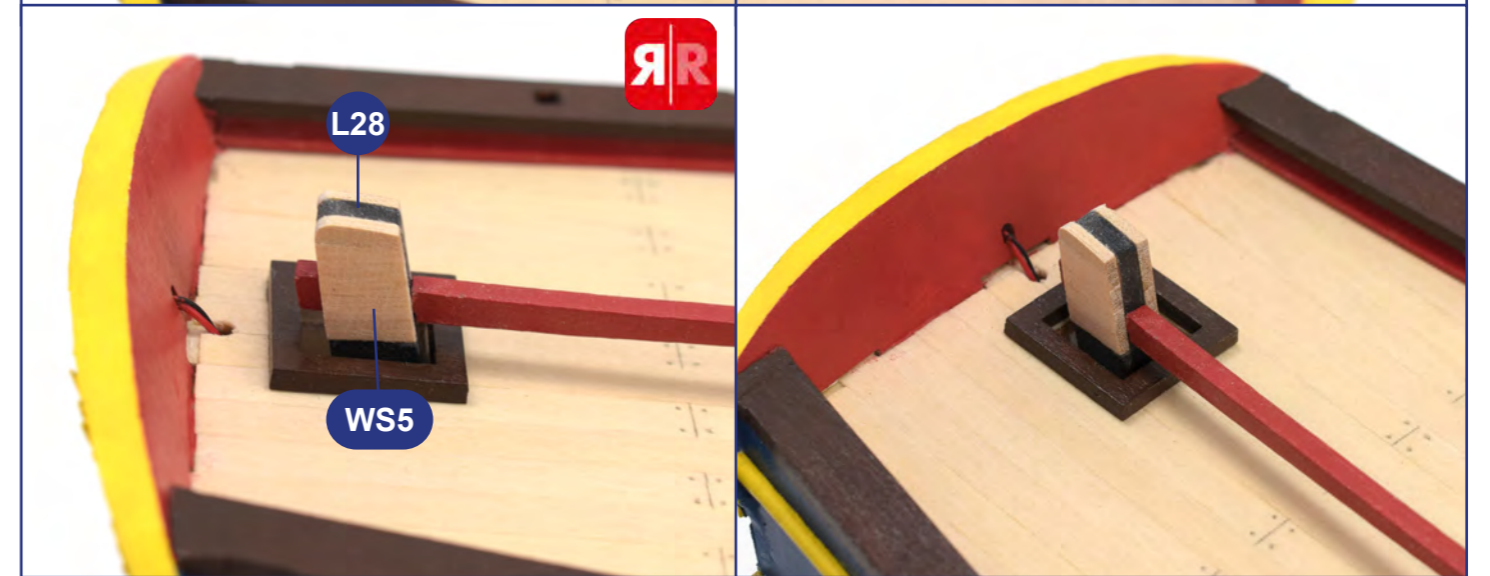
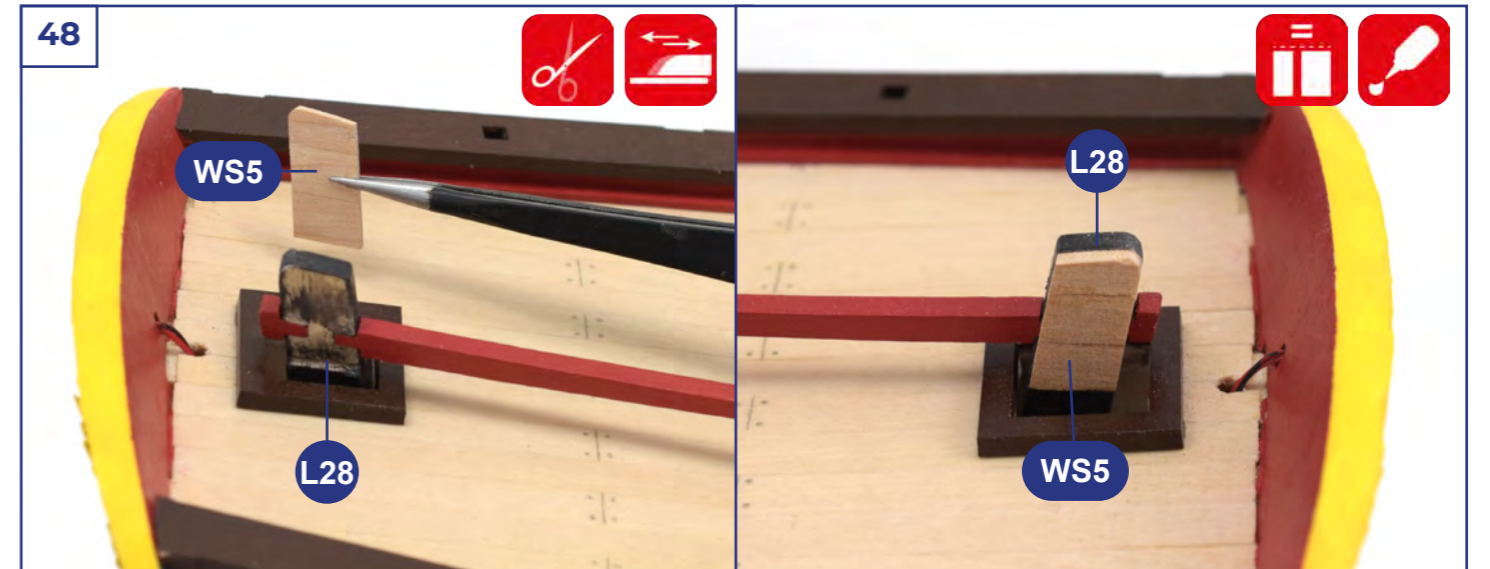
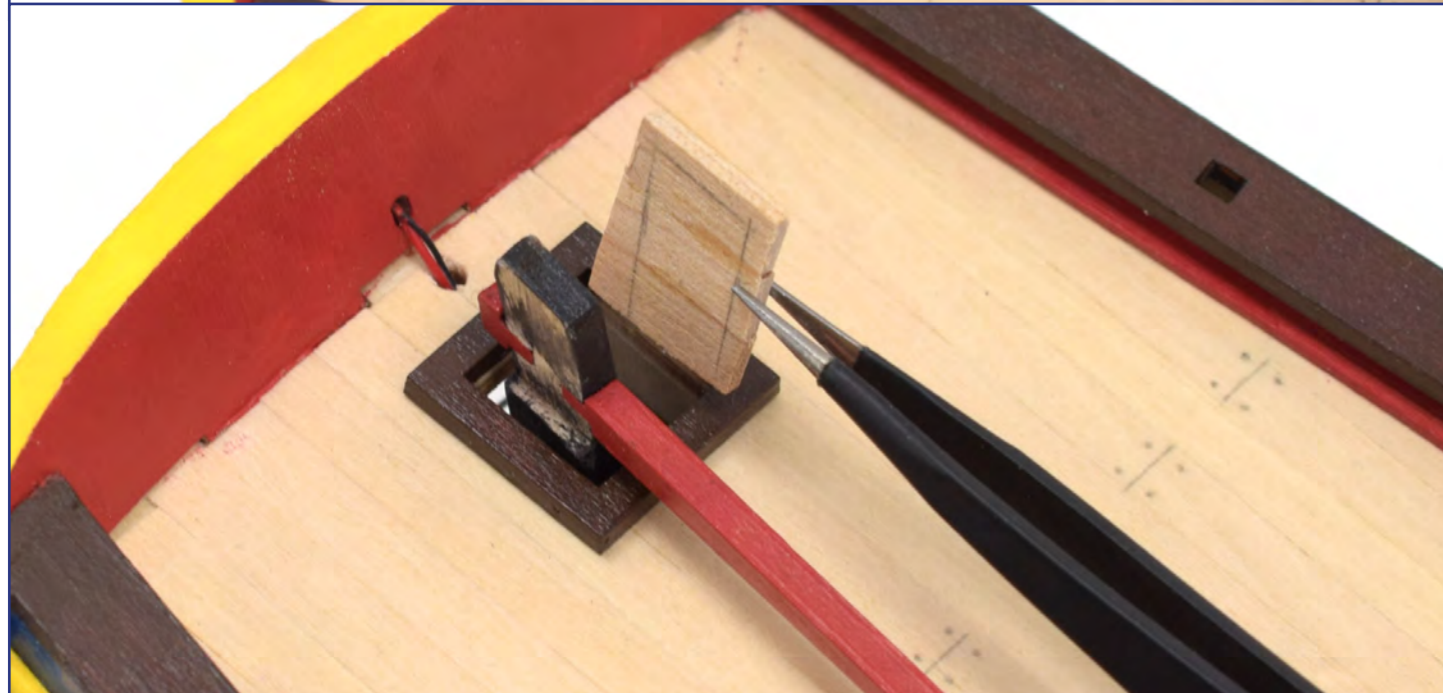
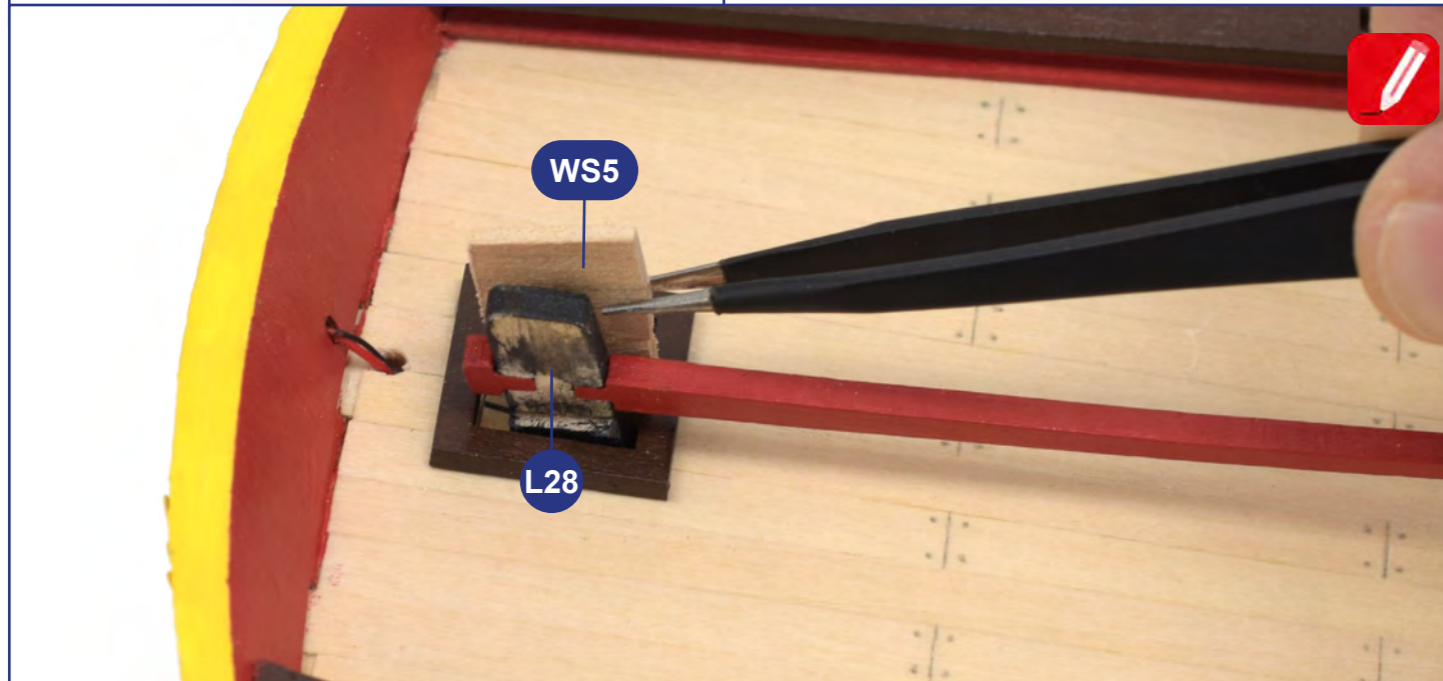

01

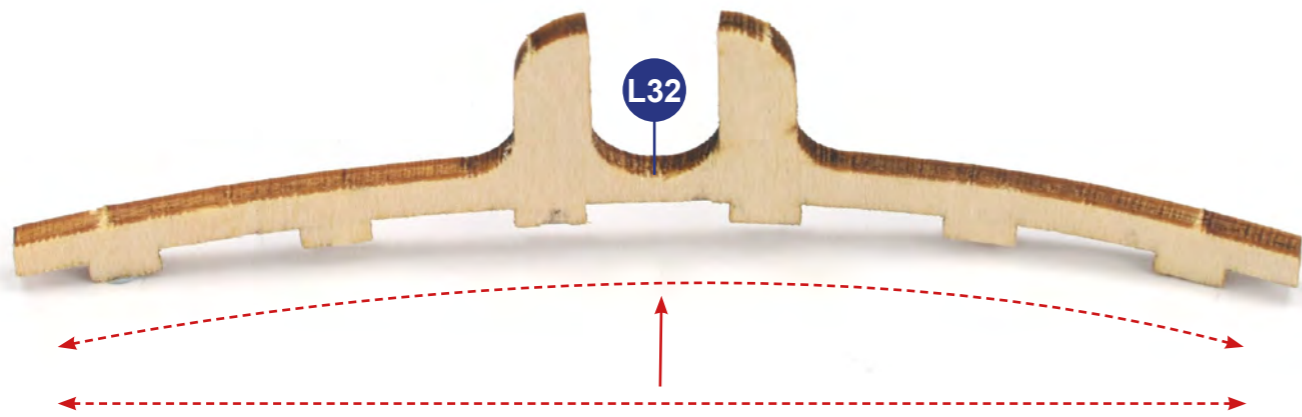
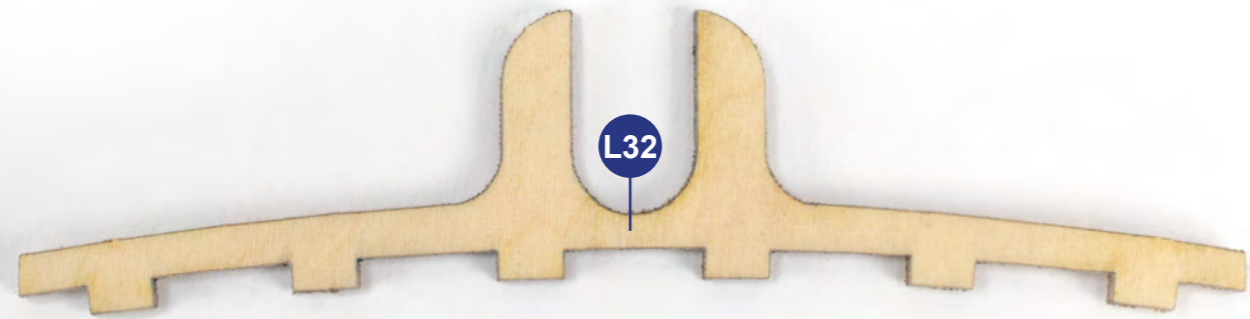

02



3

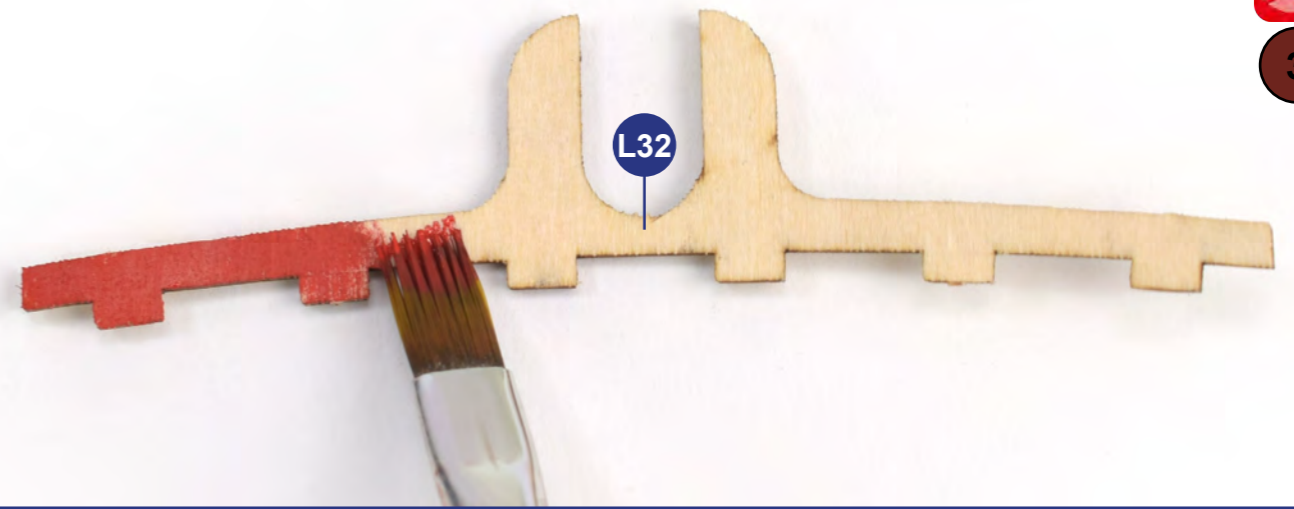

03



3



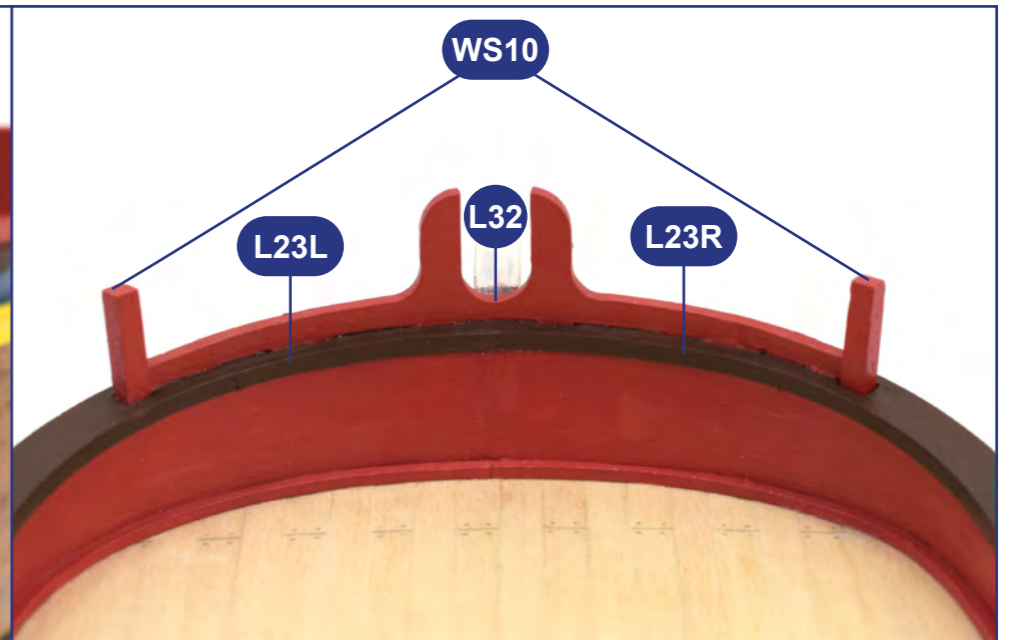
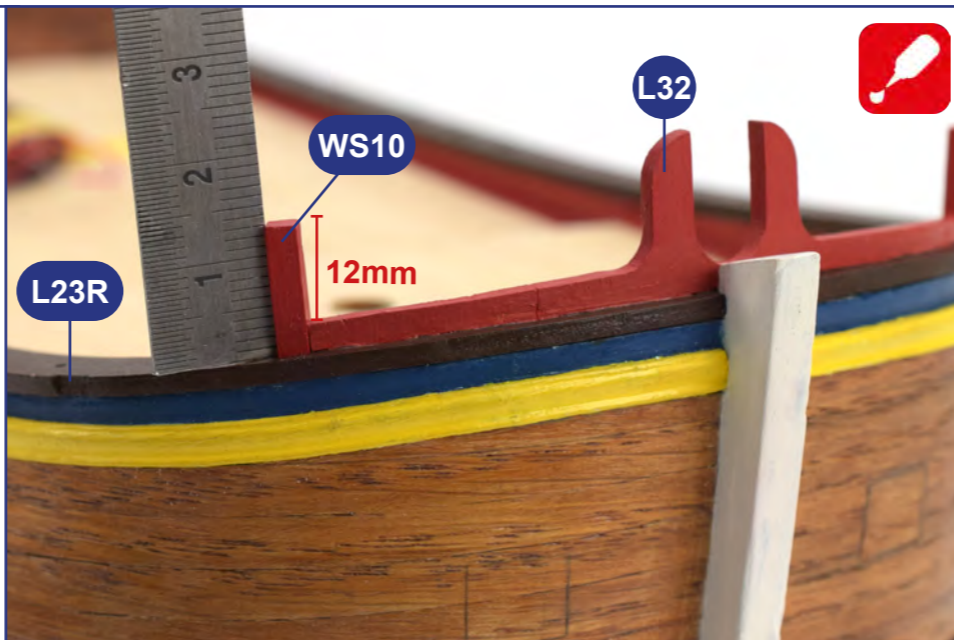
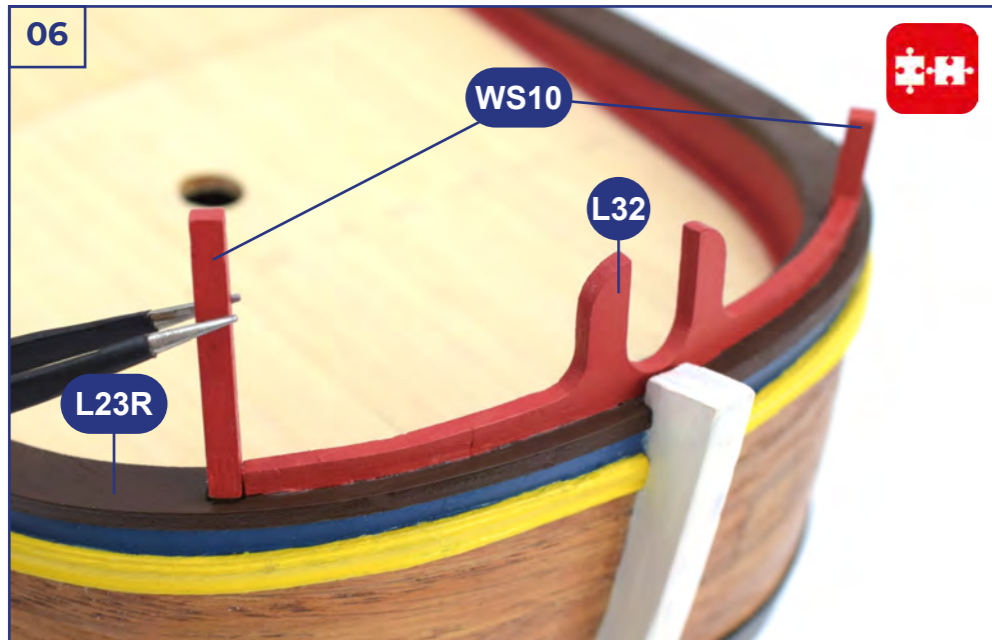
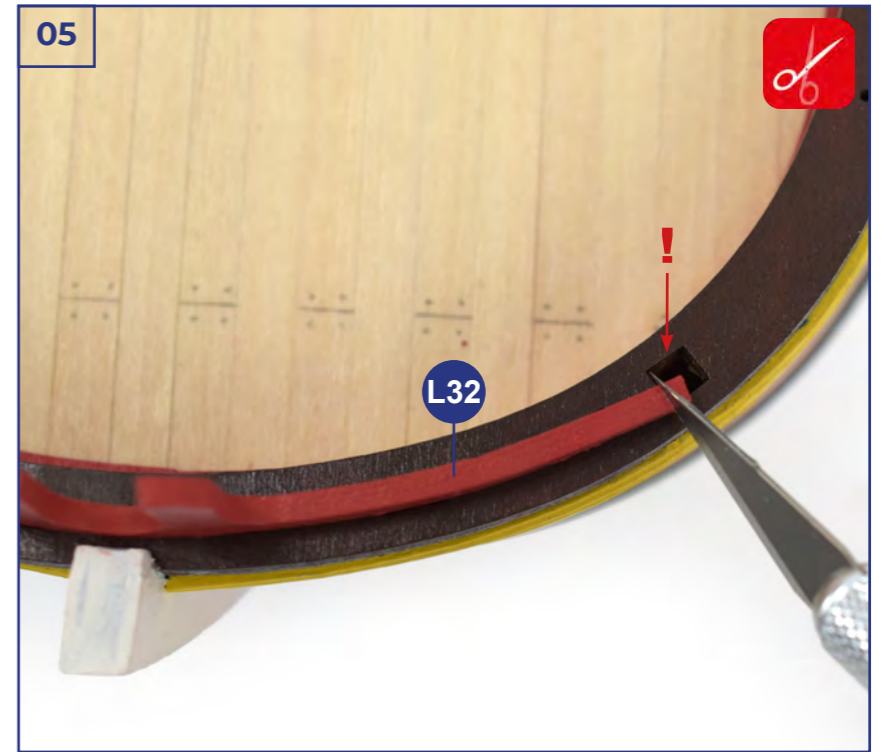
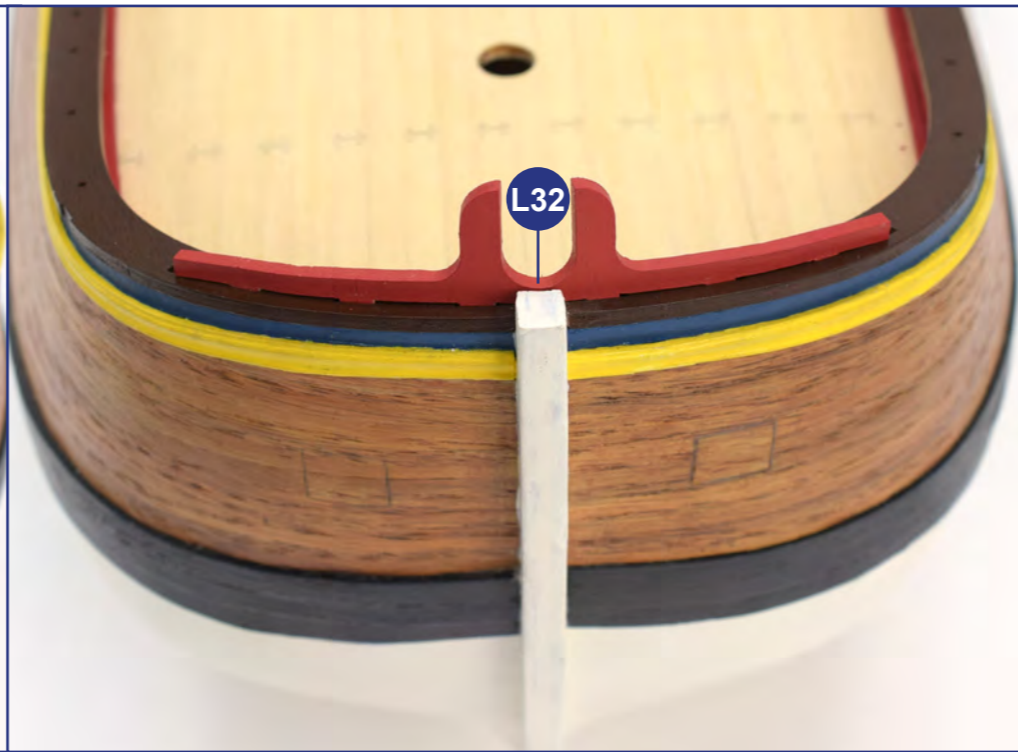
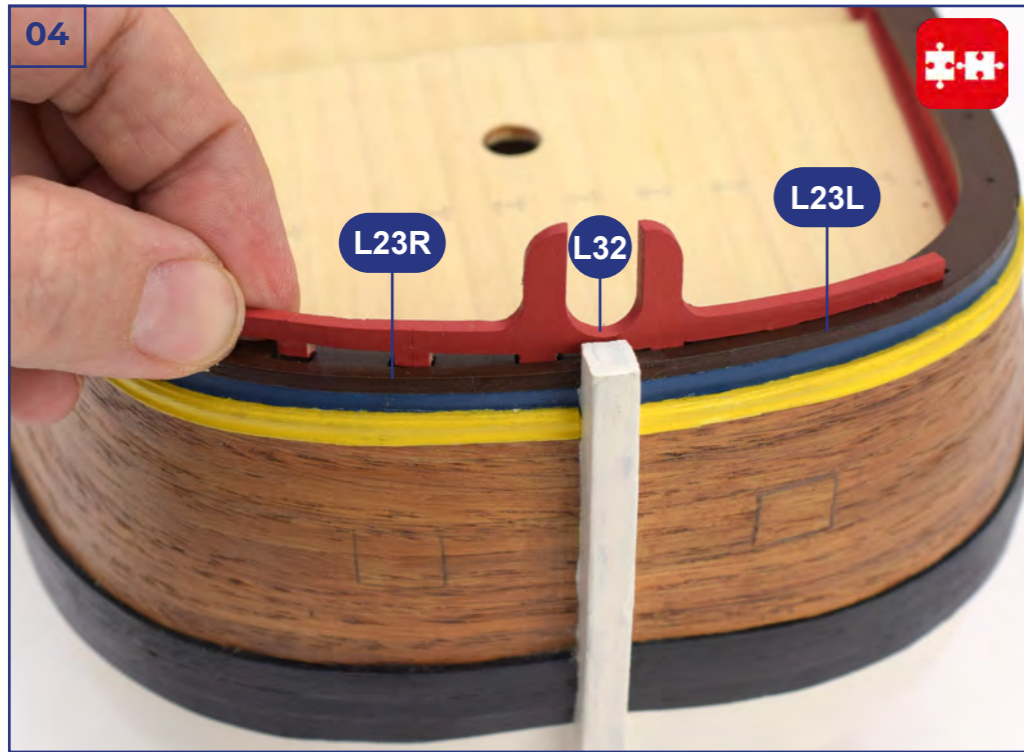

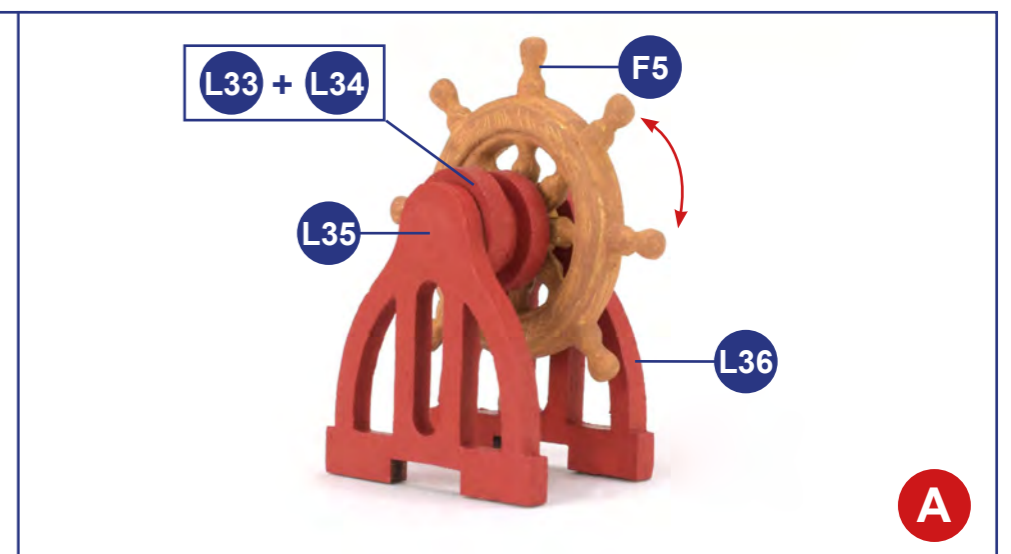
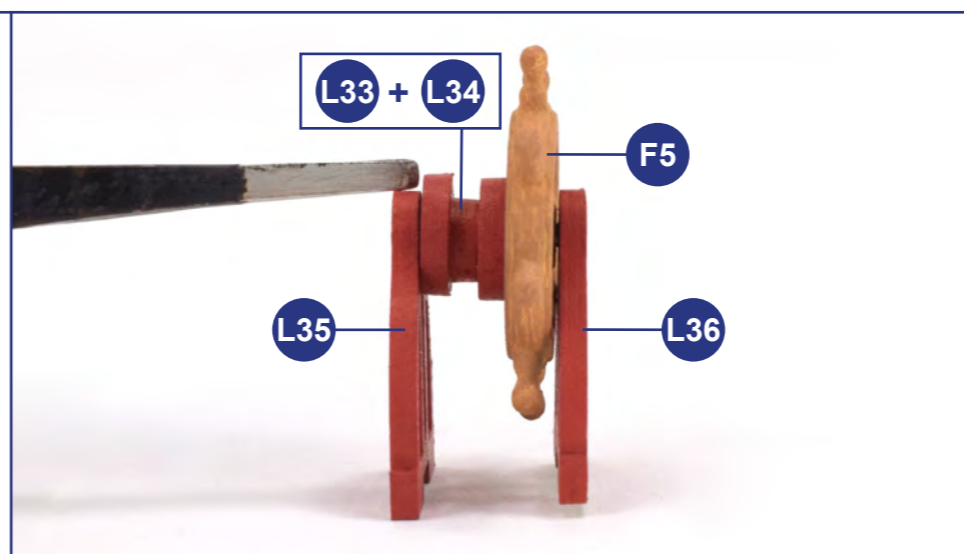
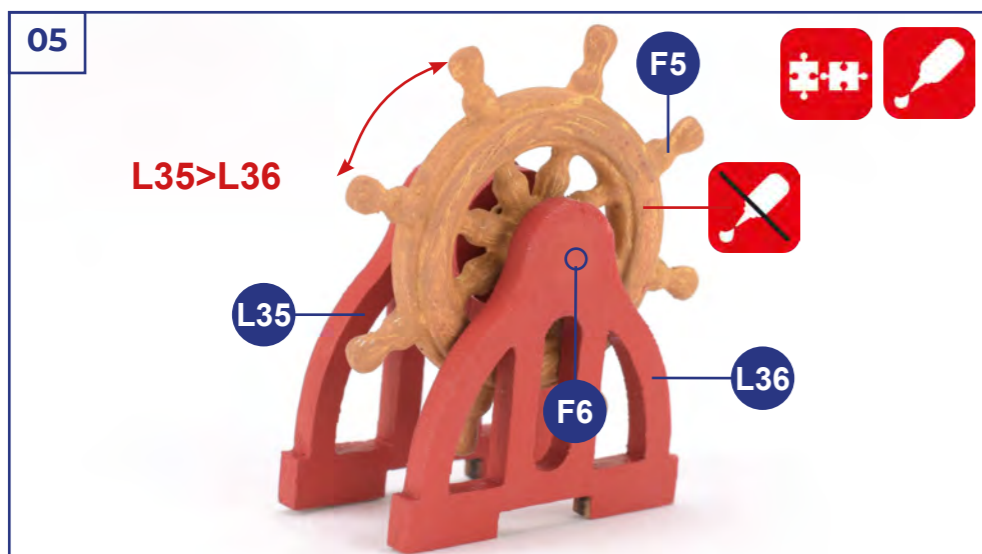
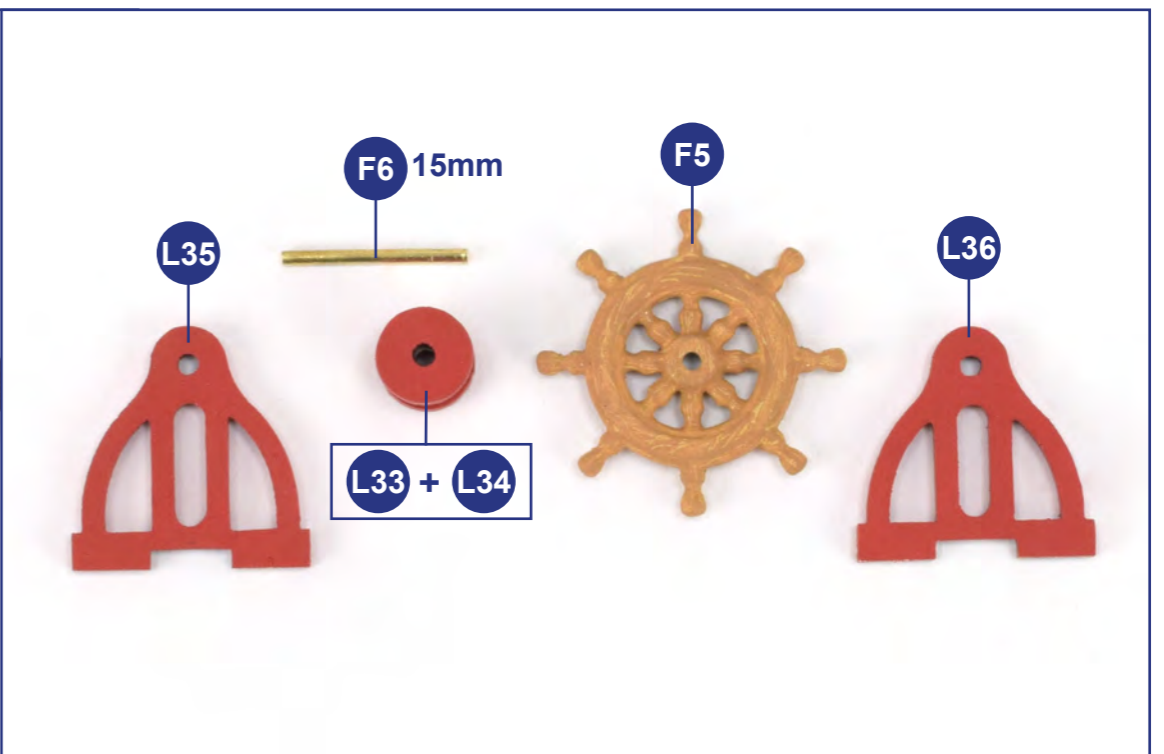
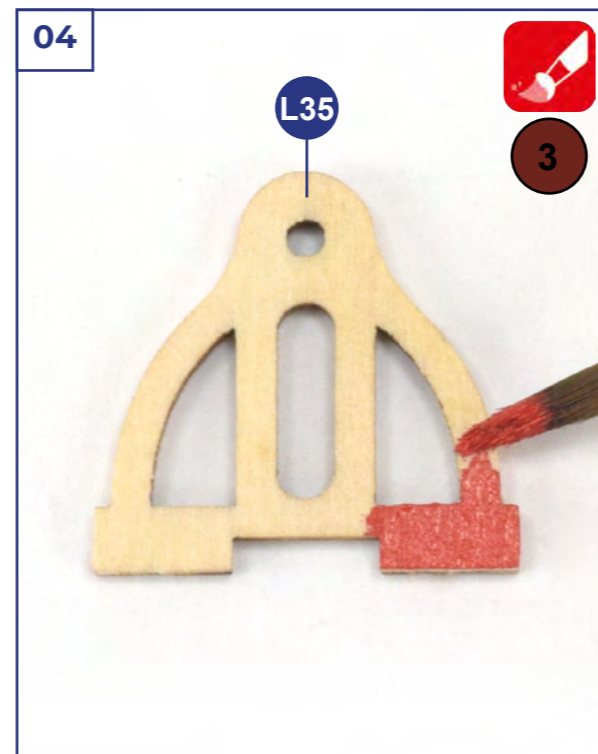
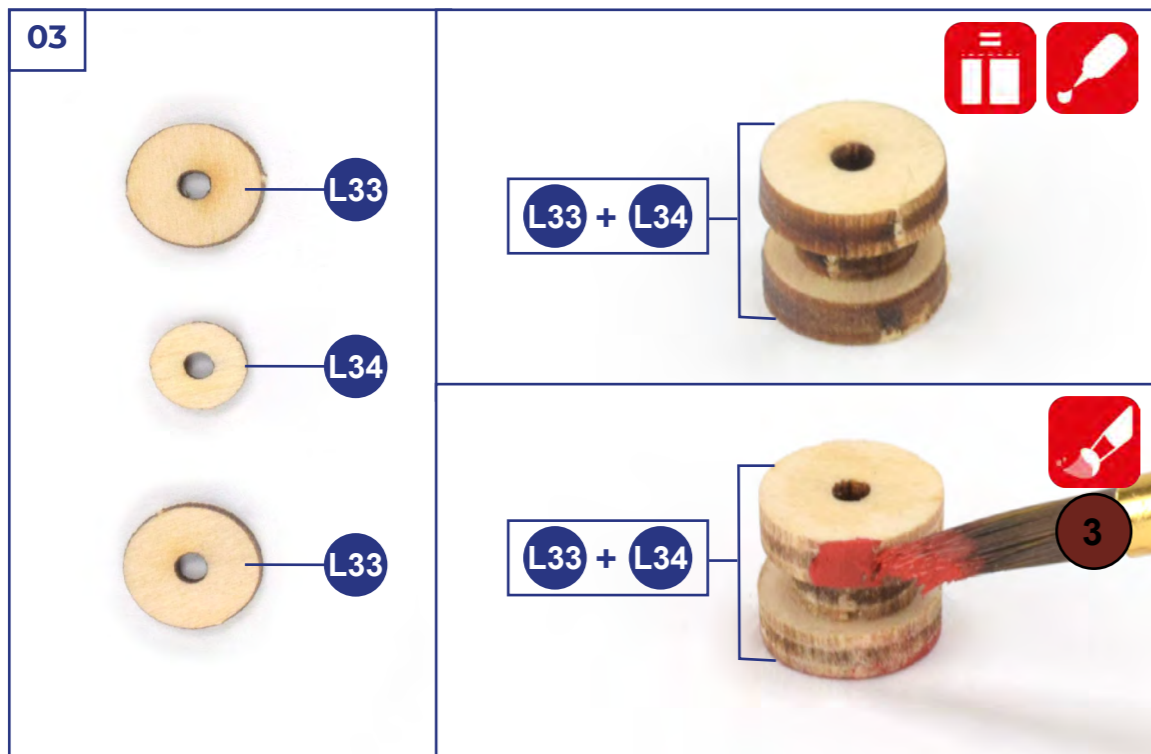
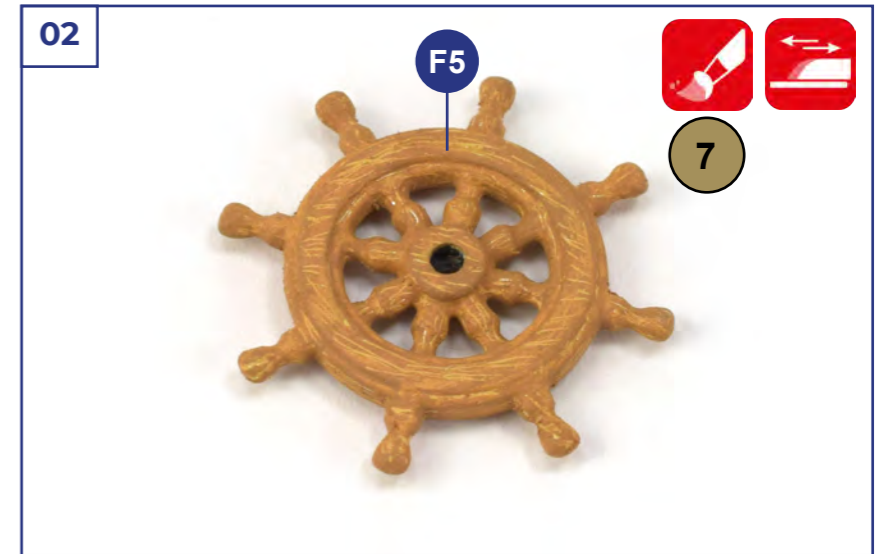
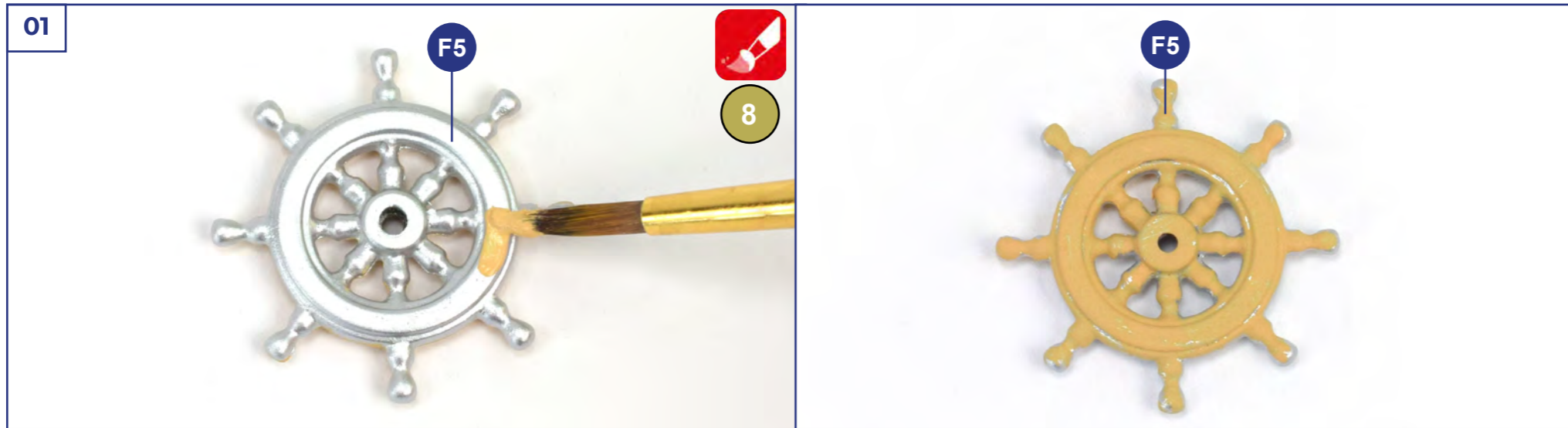

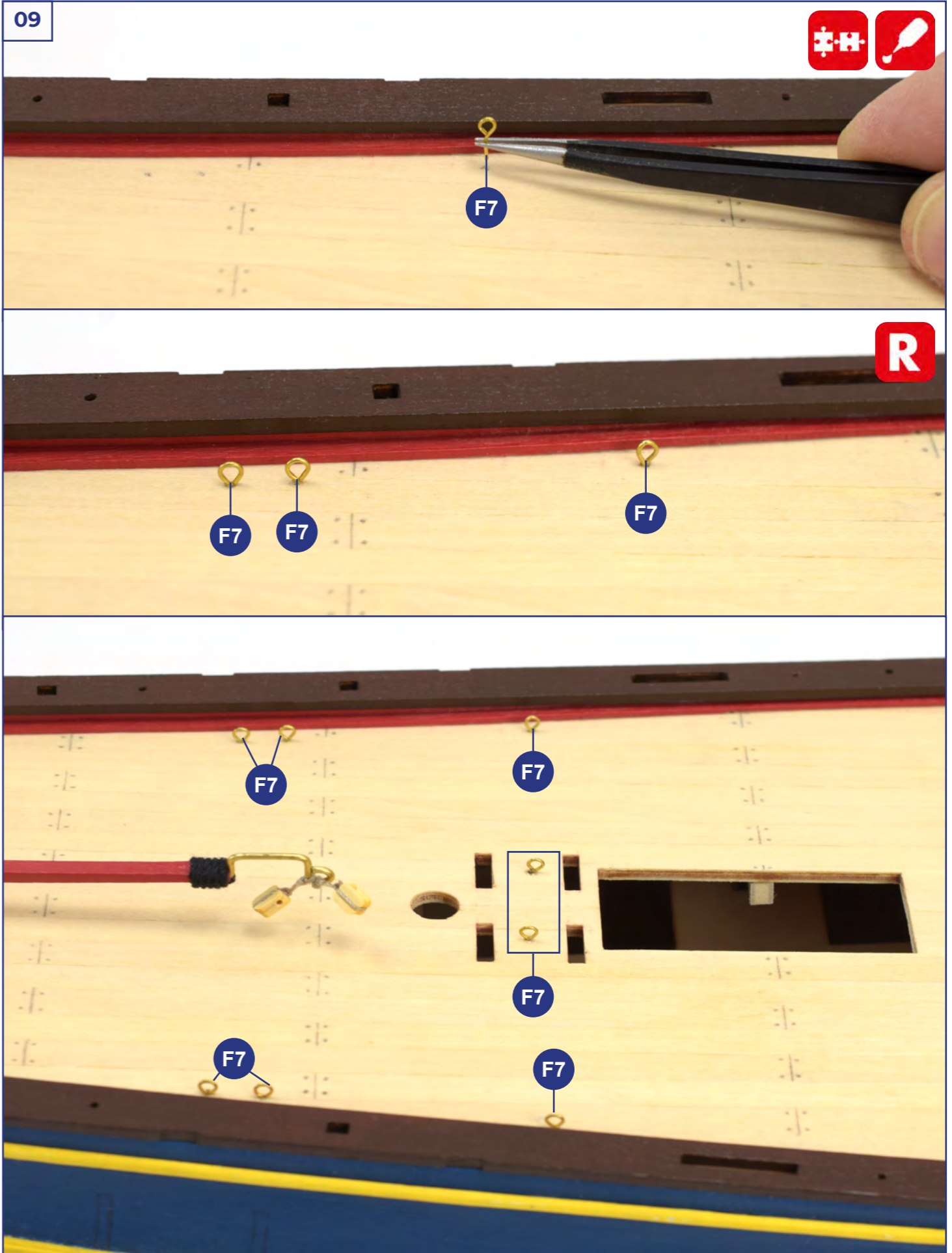
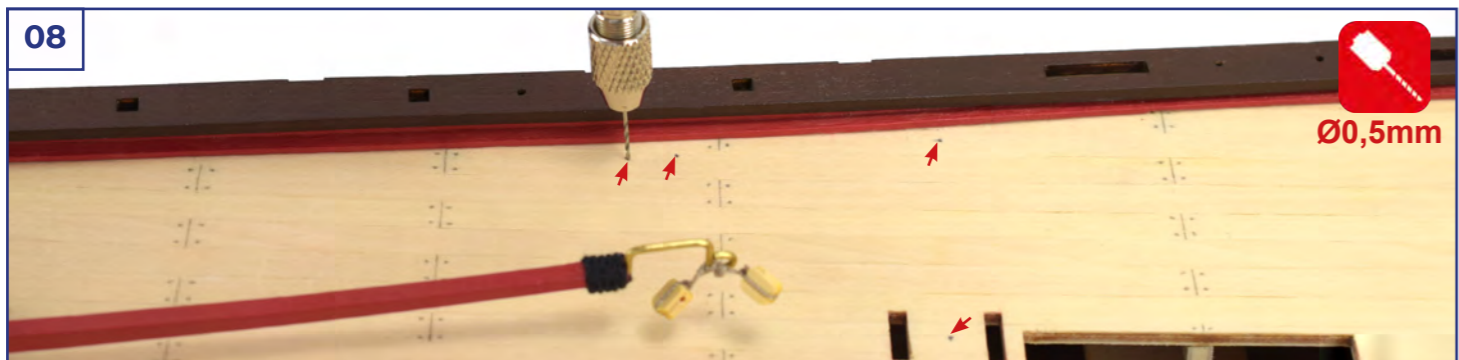
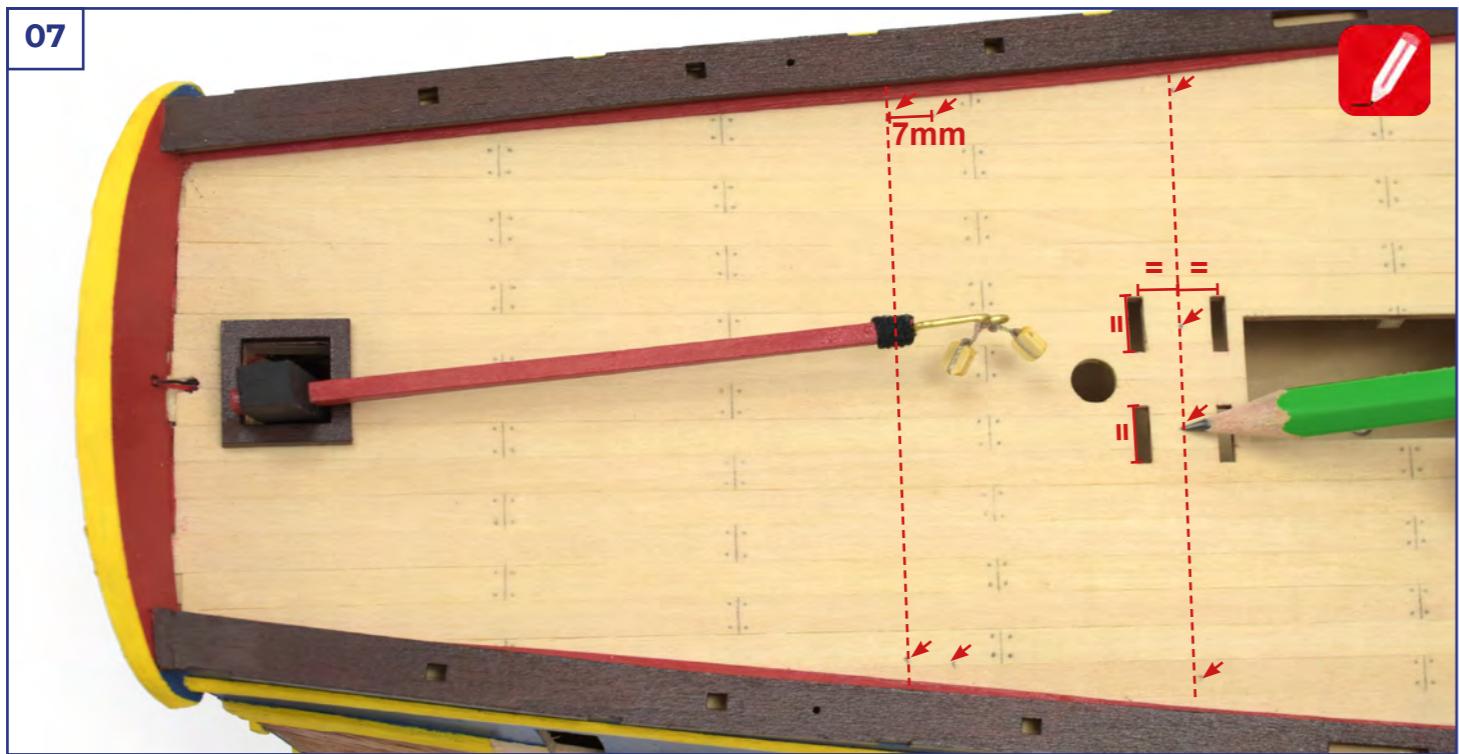
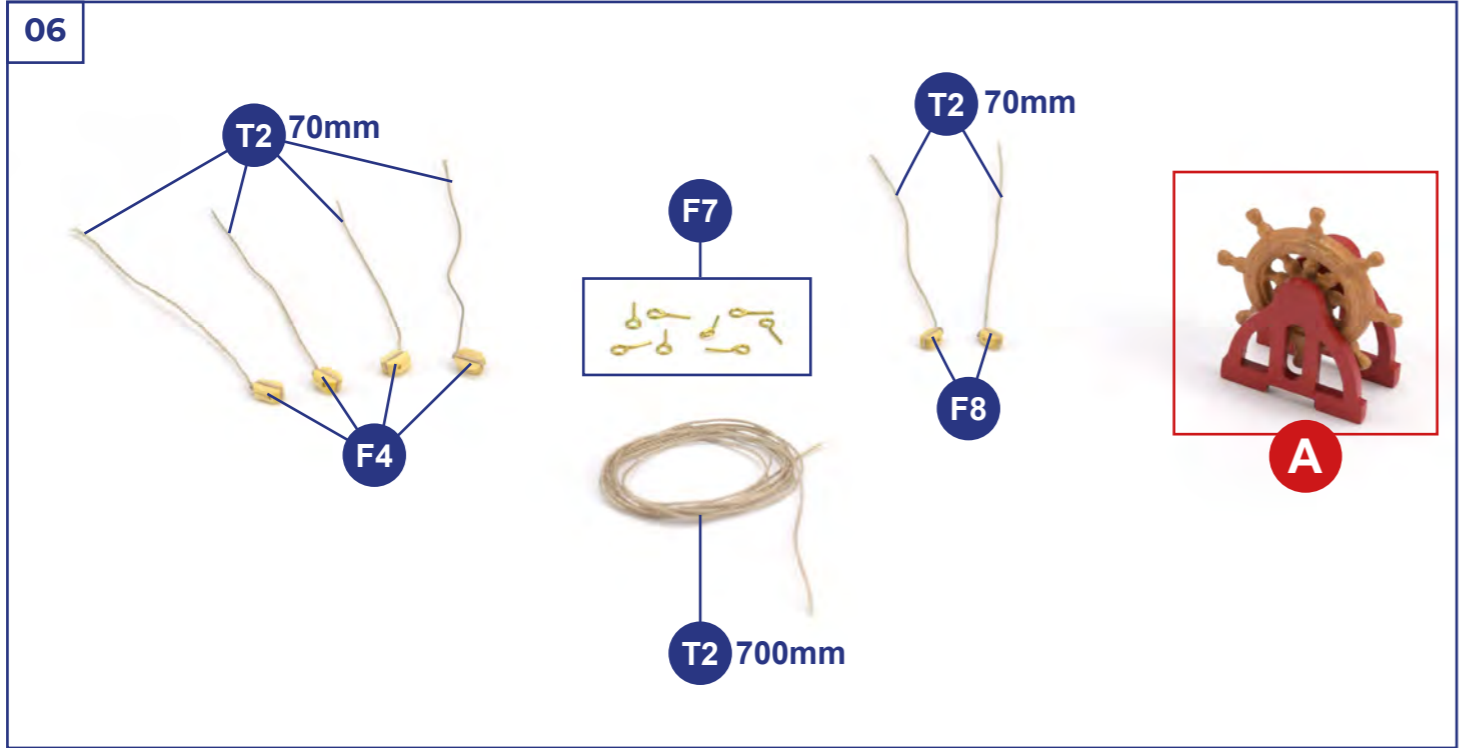

10

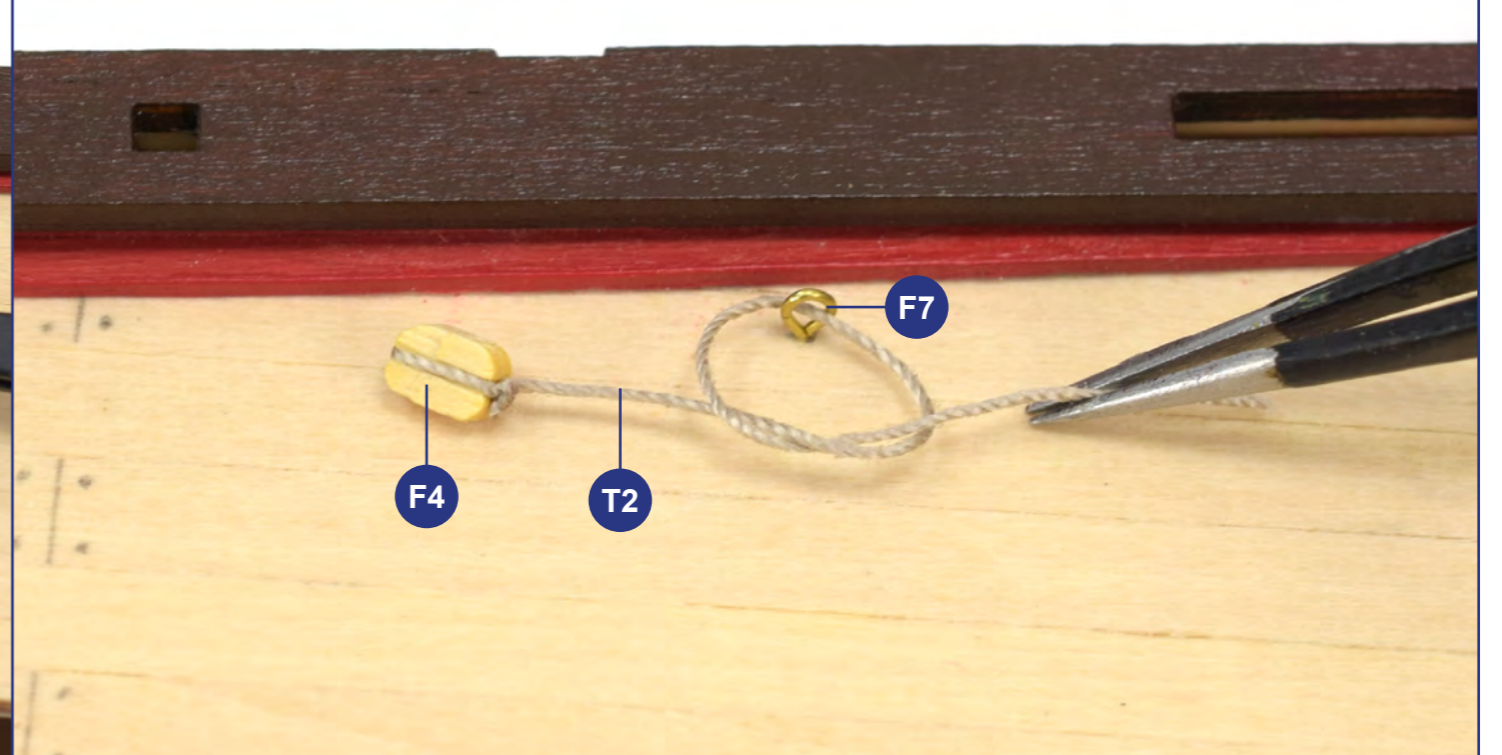
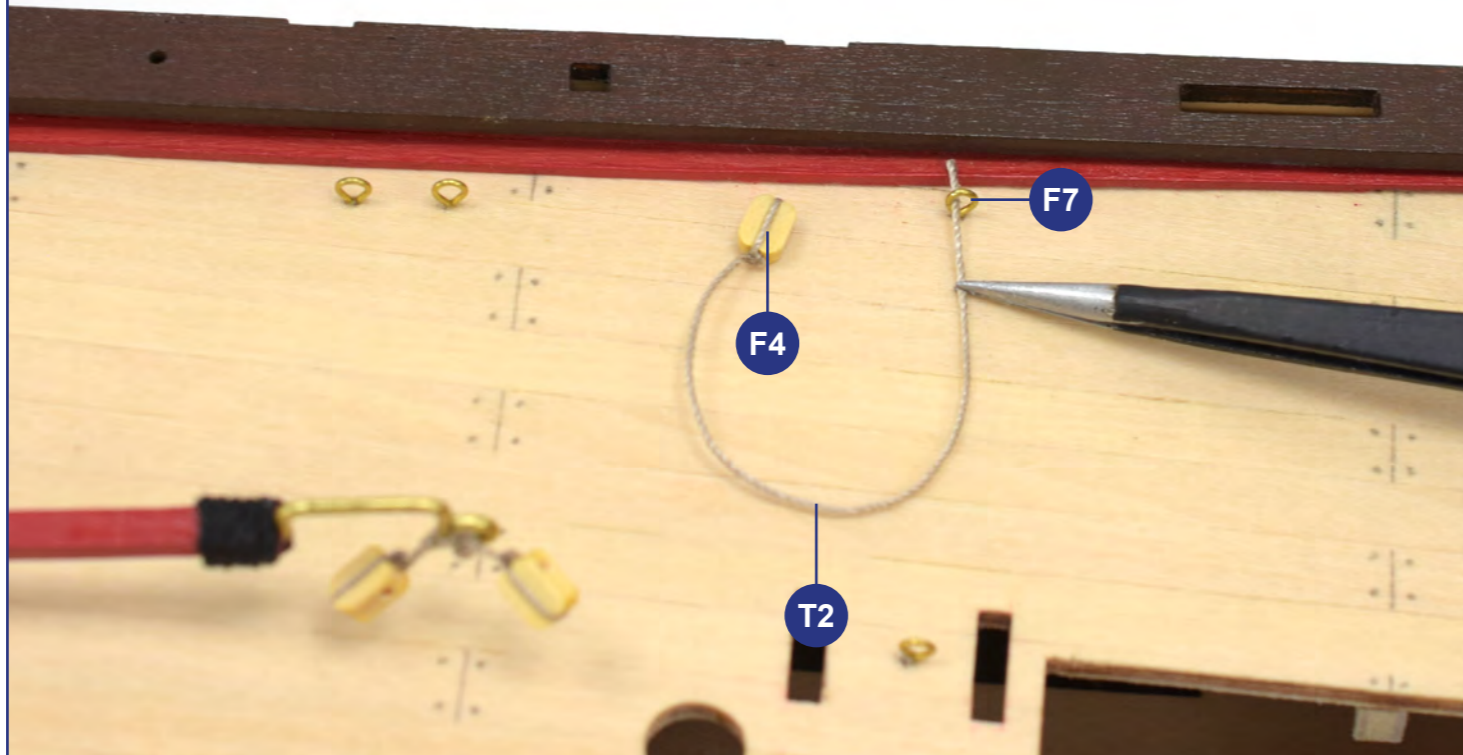

11

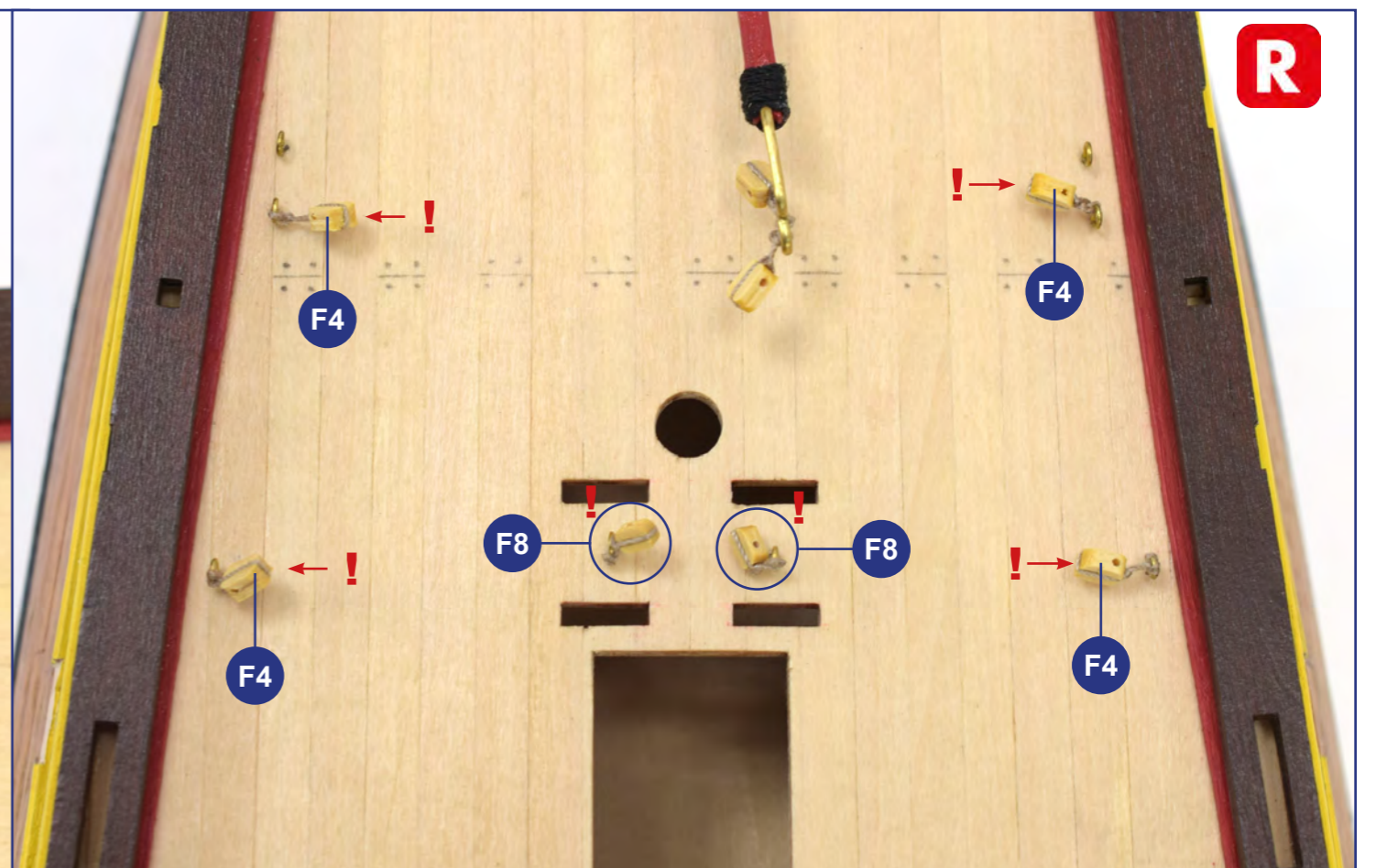
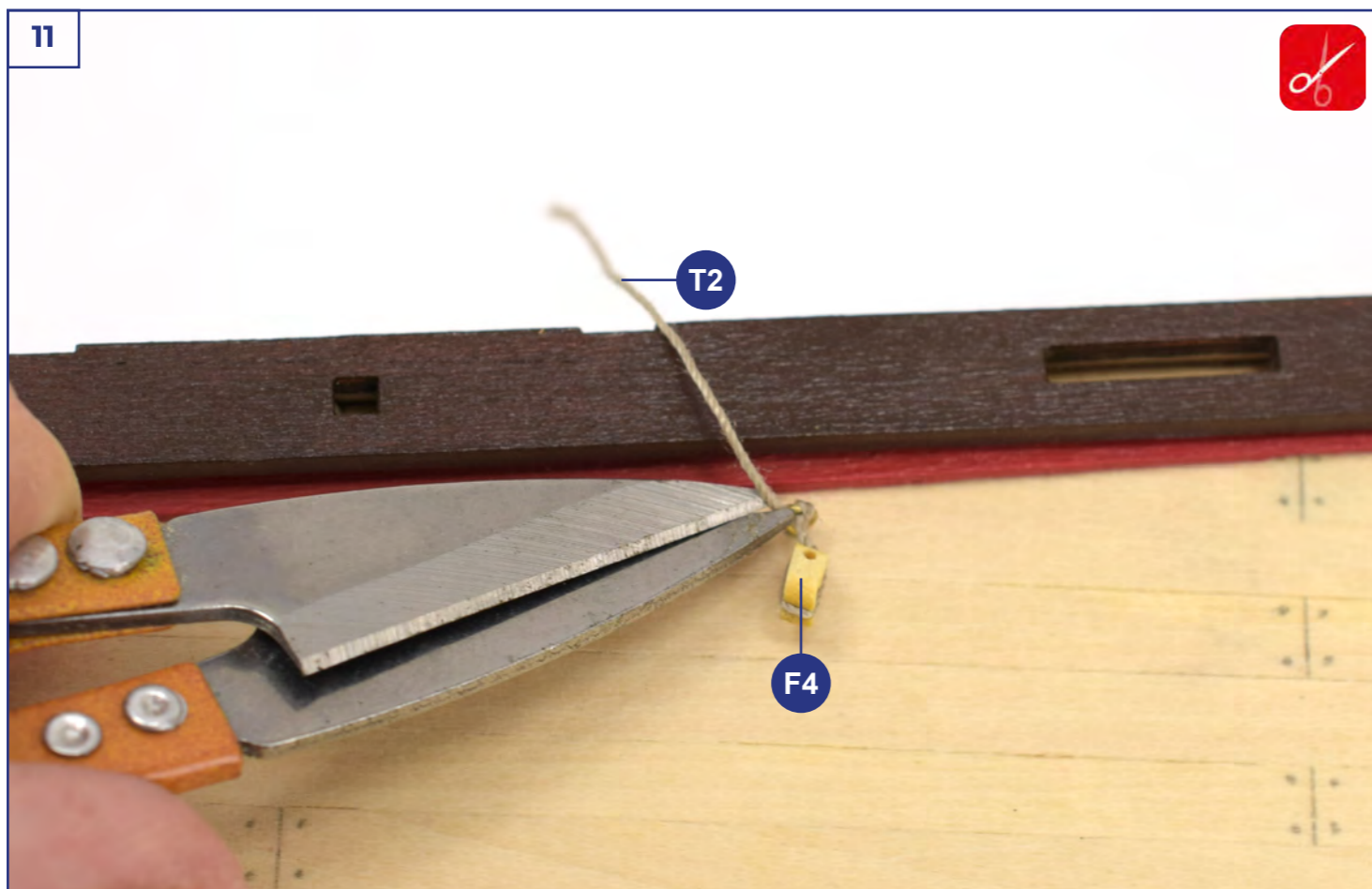

12

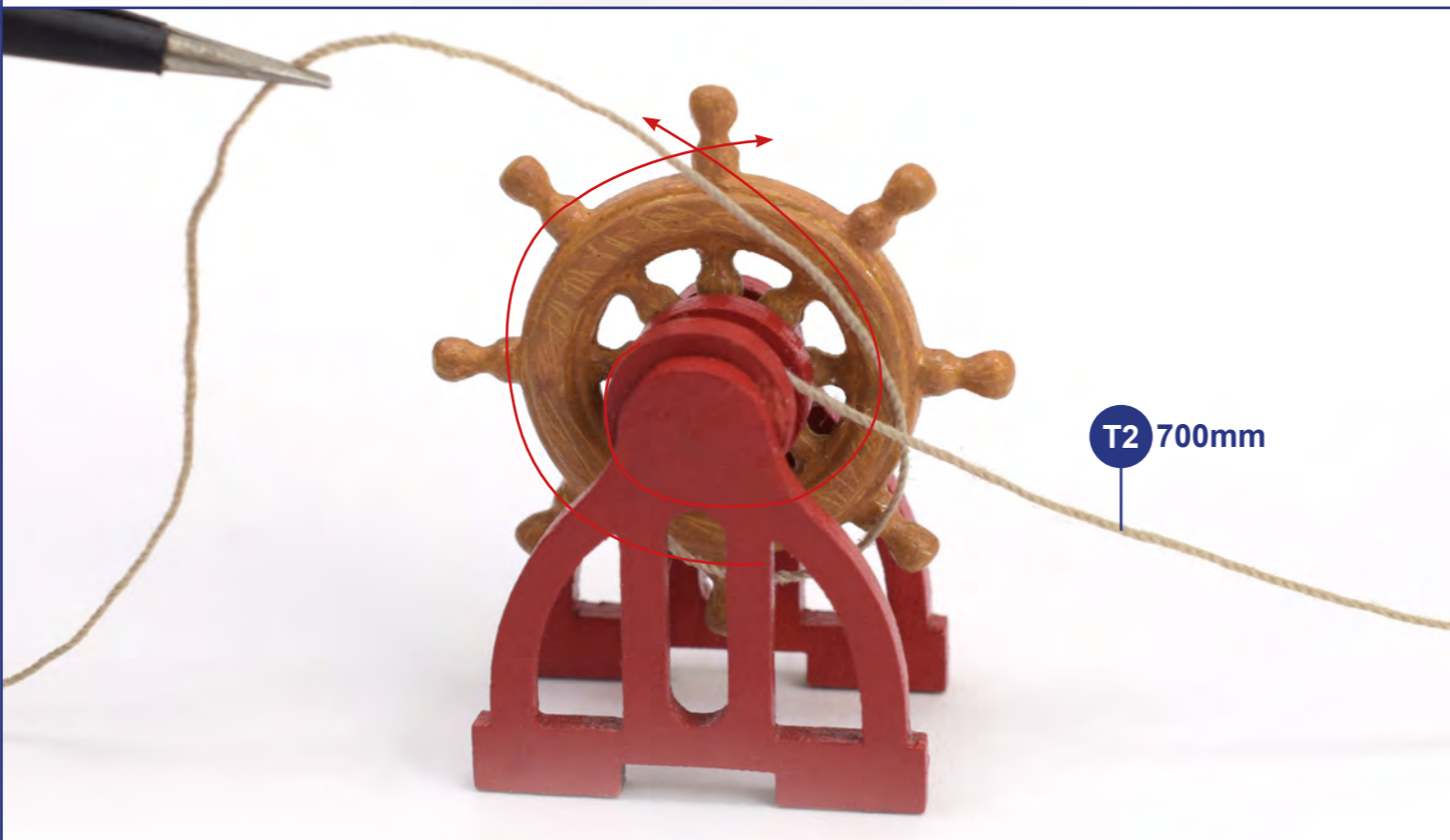
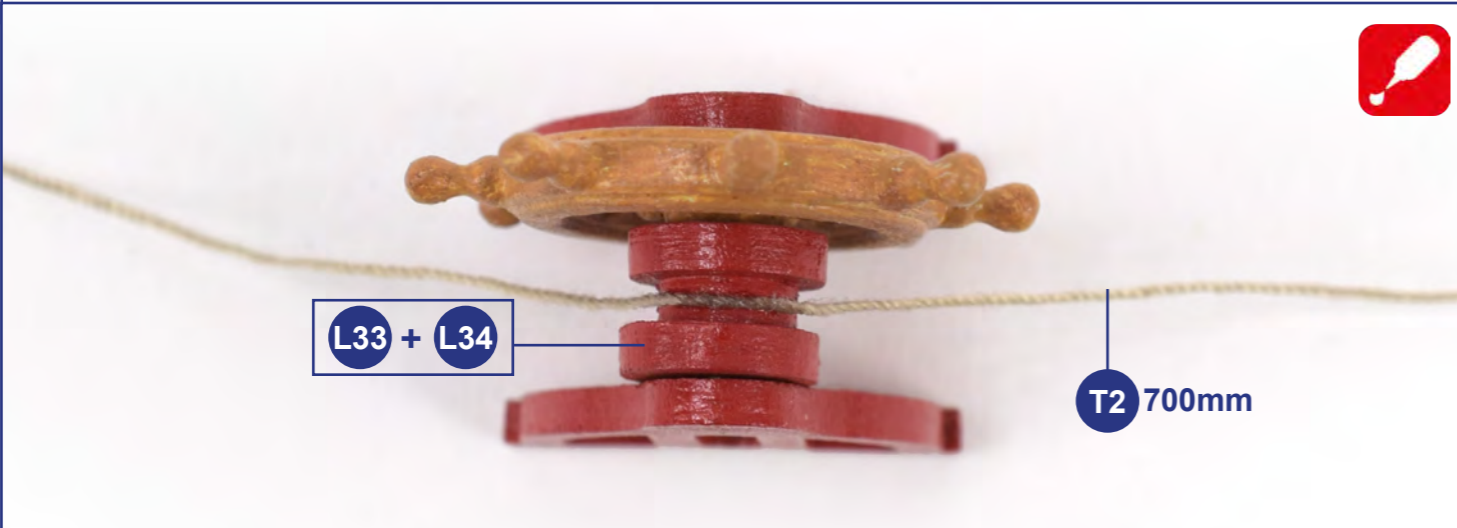
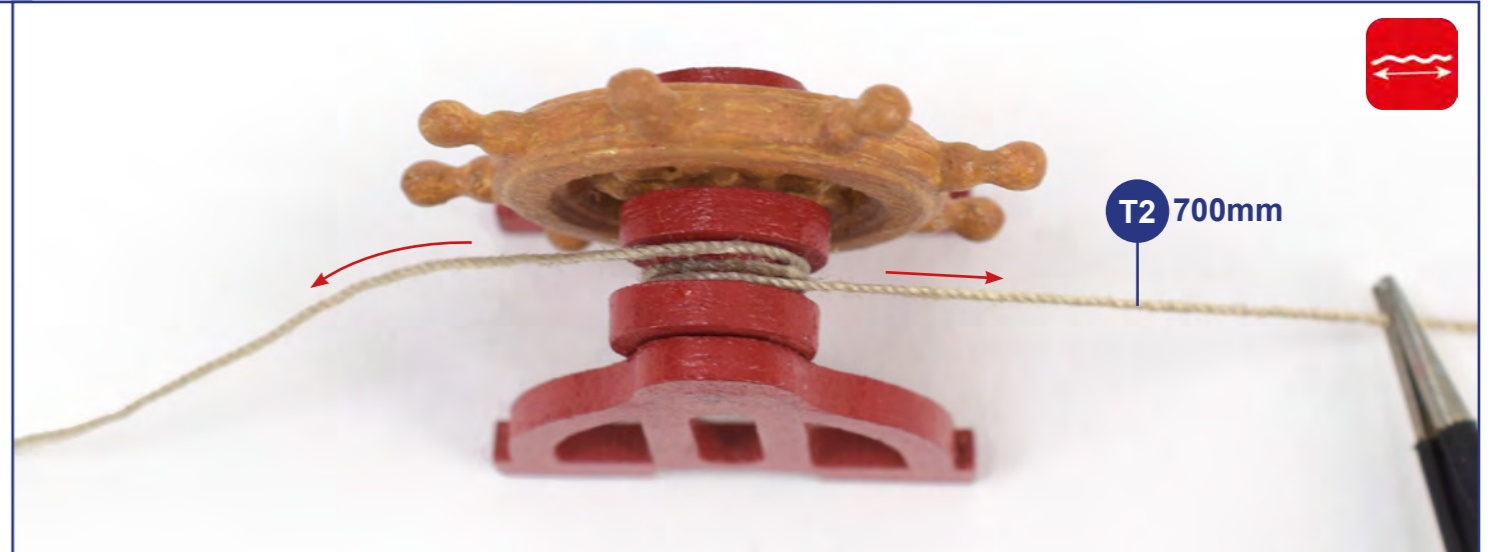
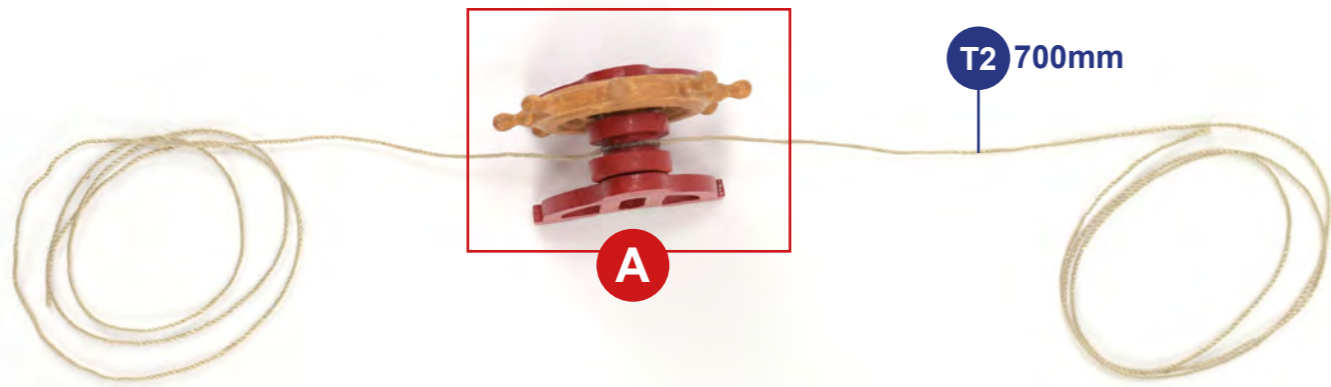

13

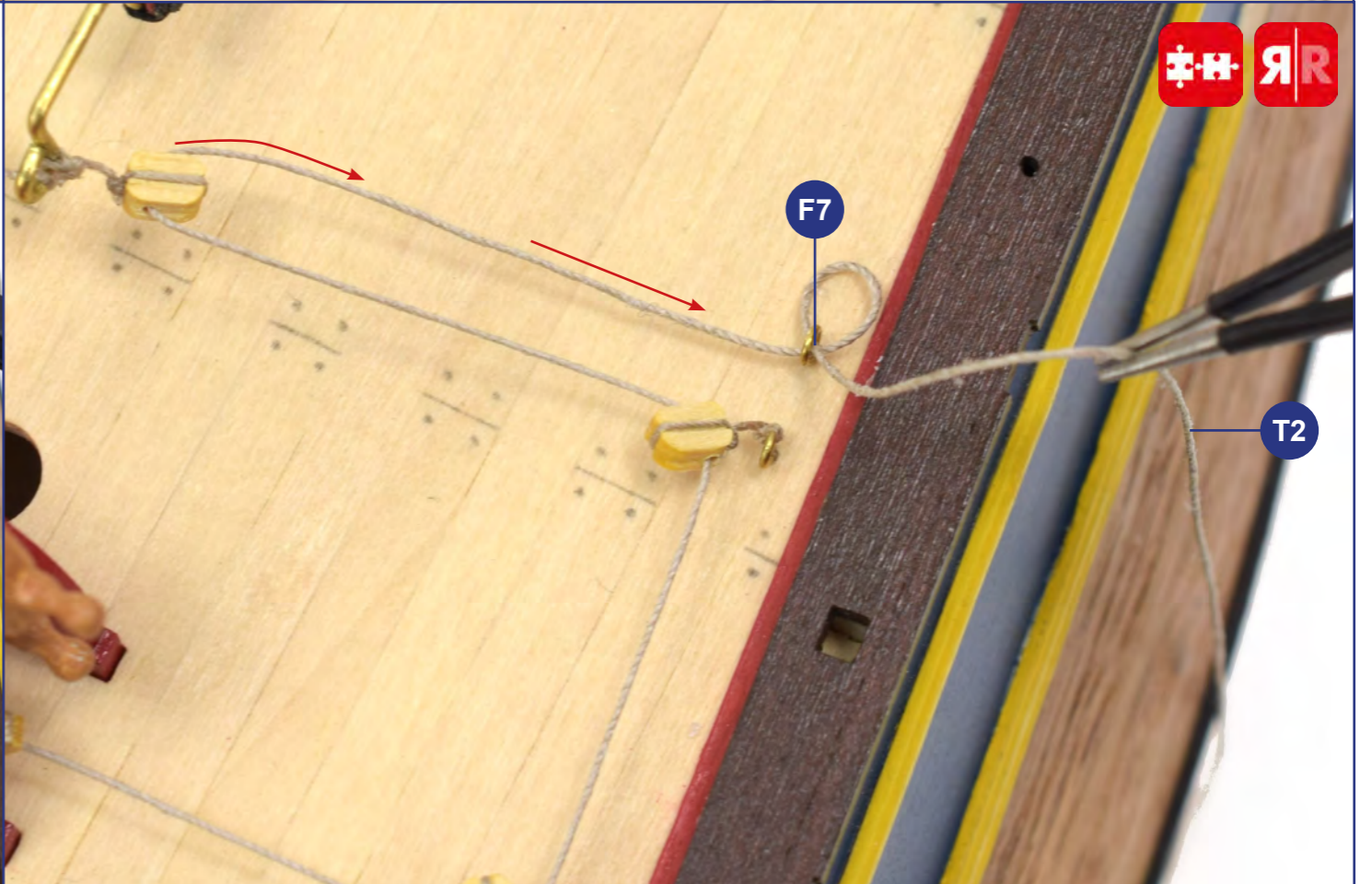
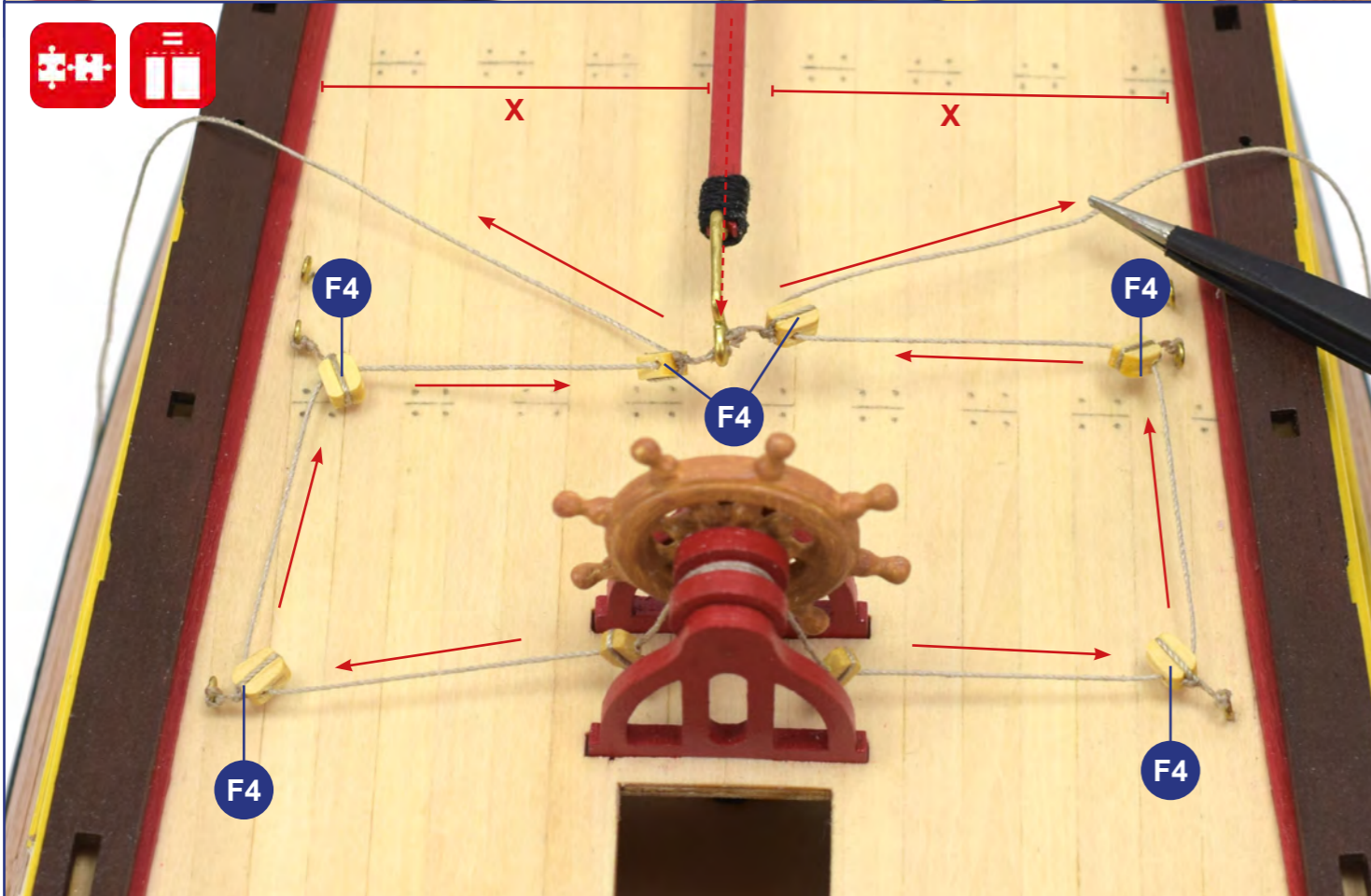
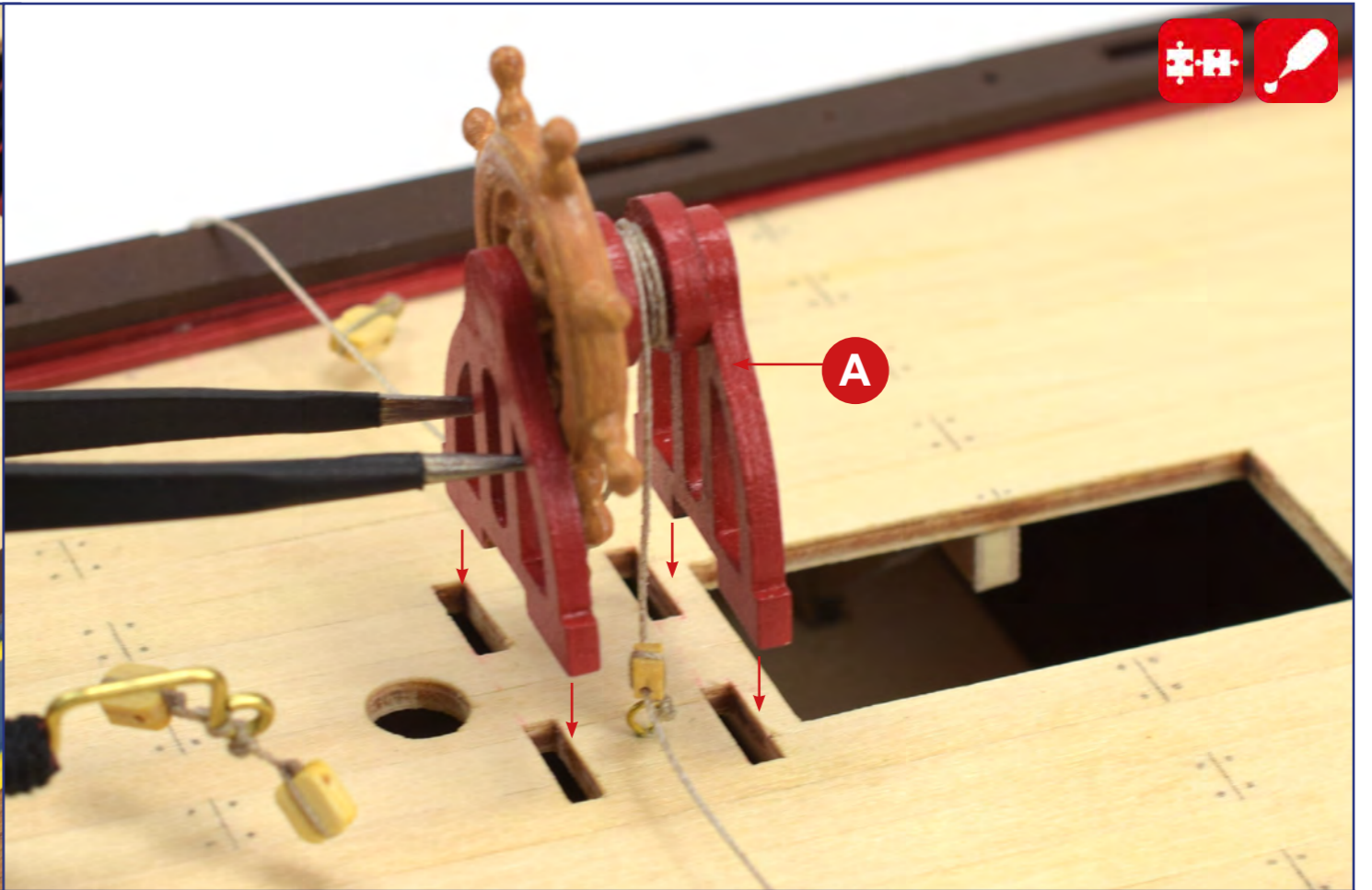
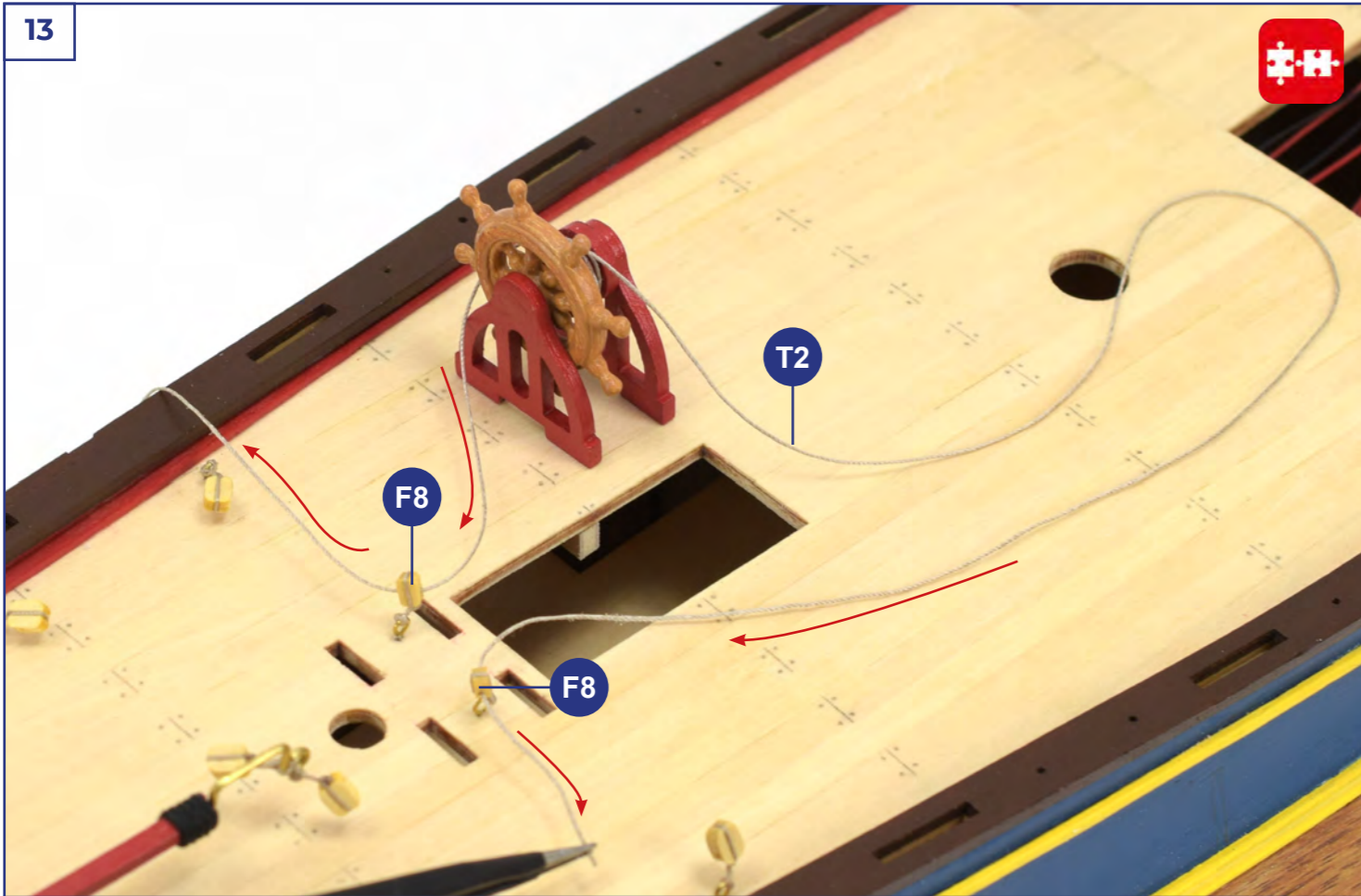

14

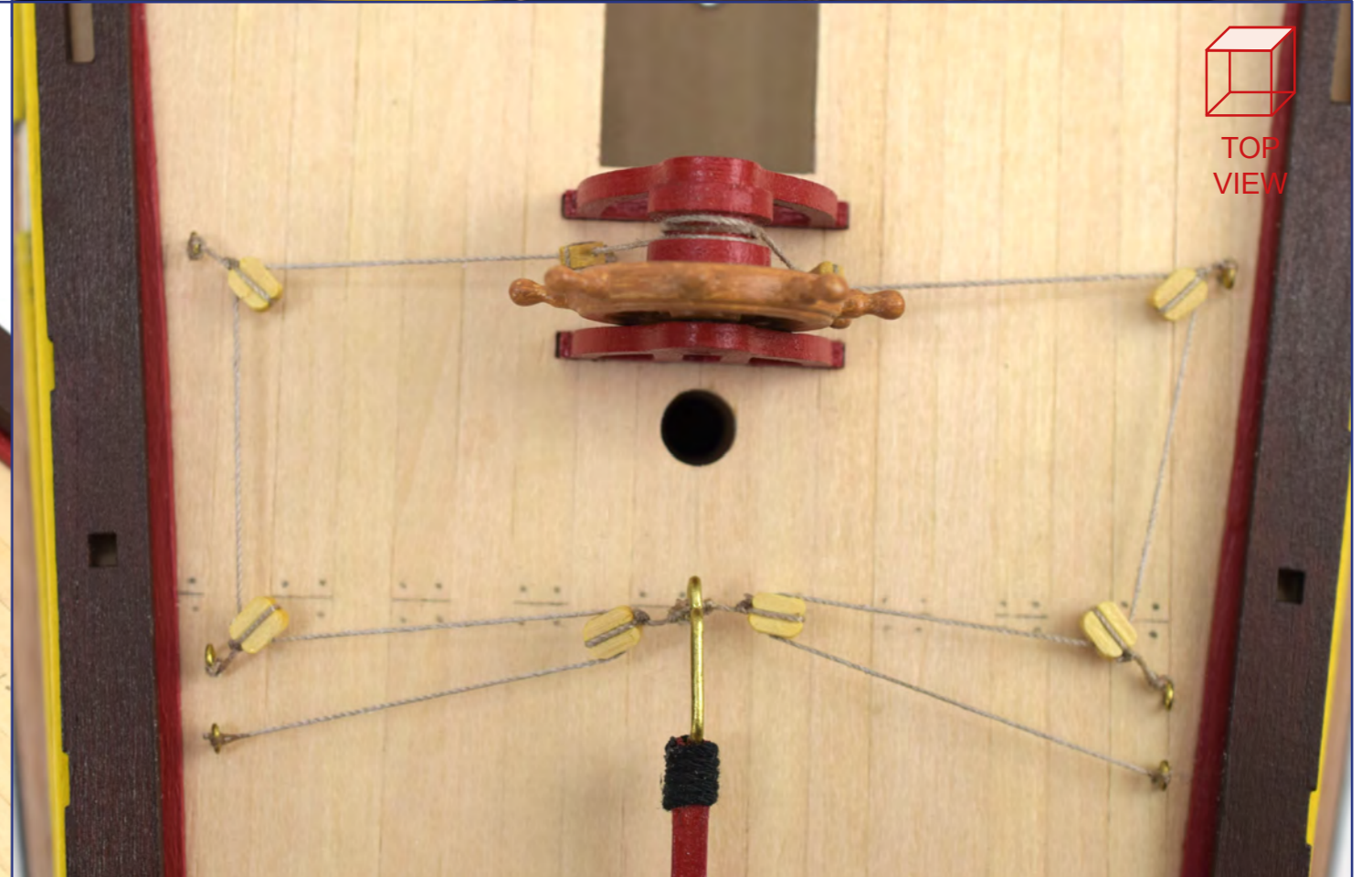
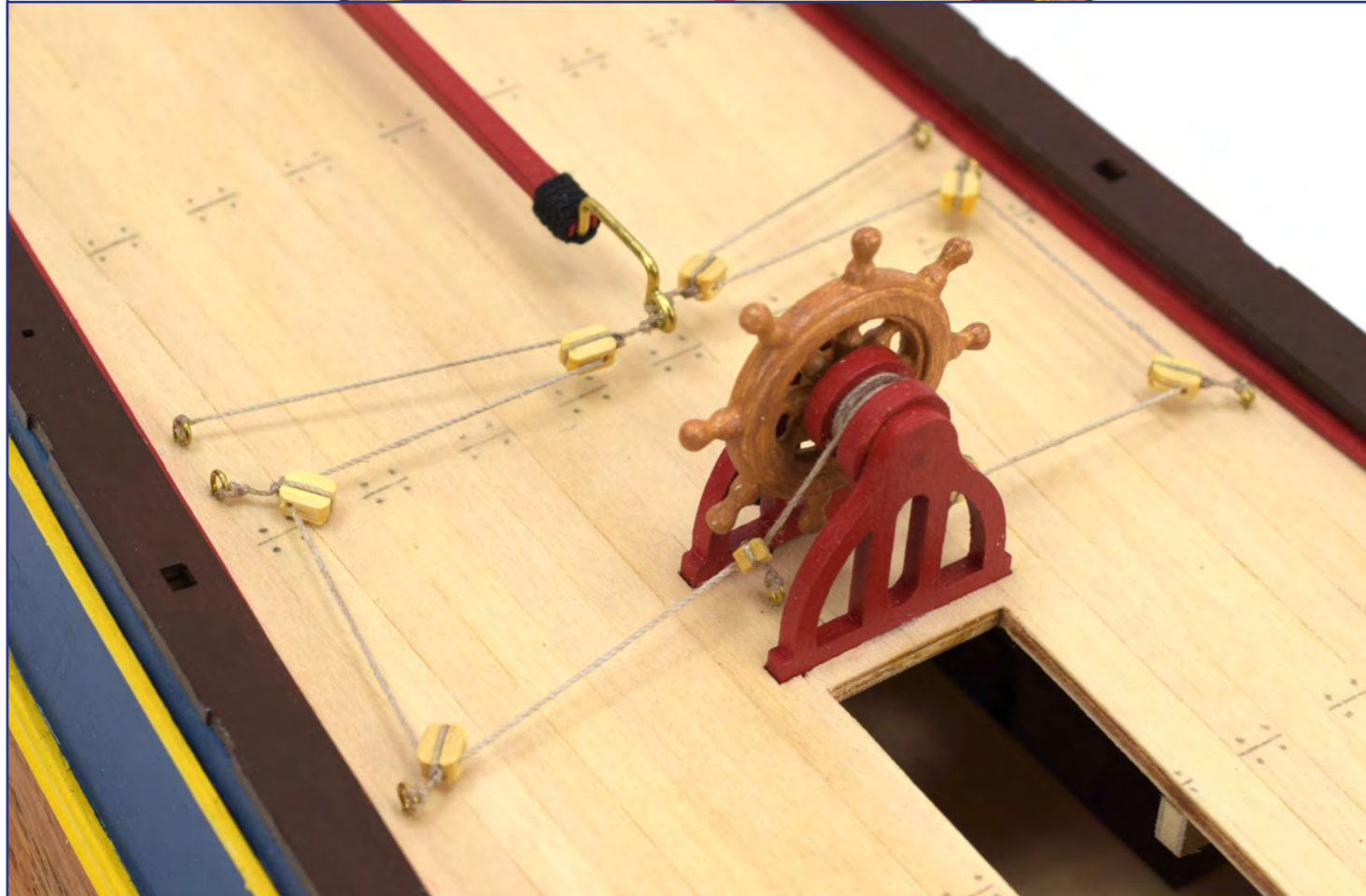
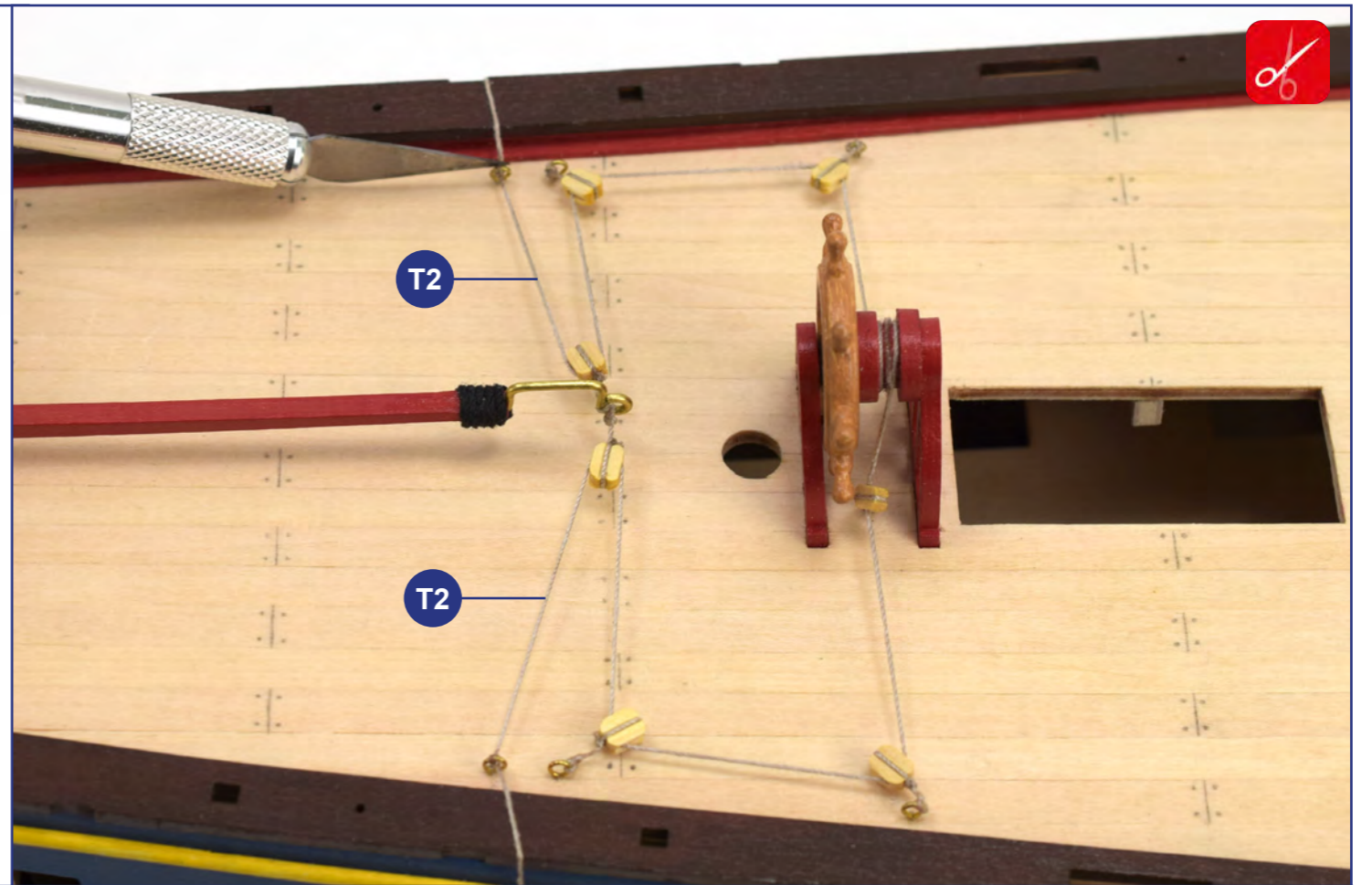
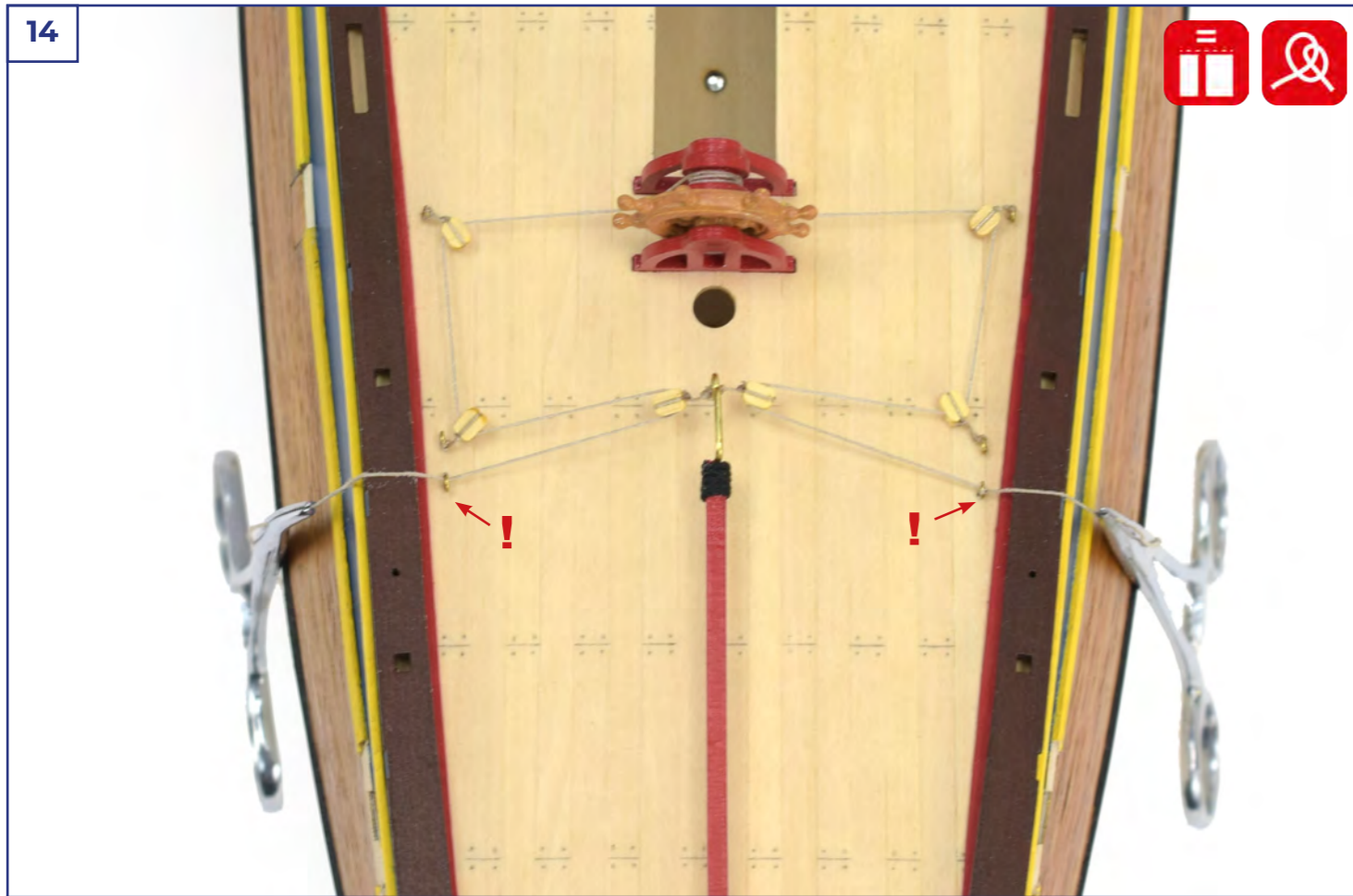

01

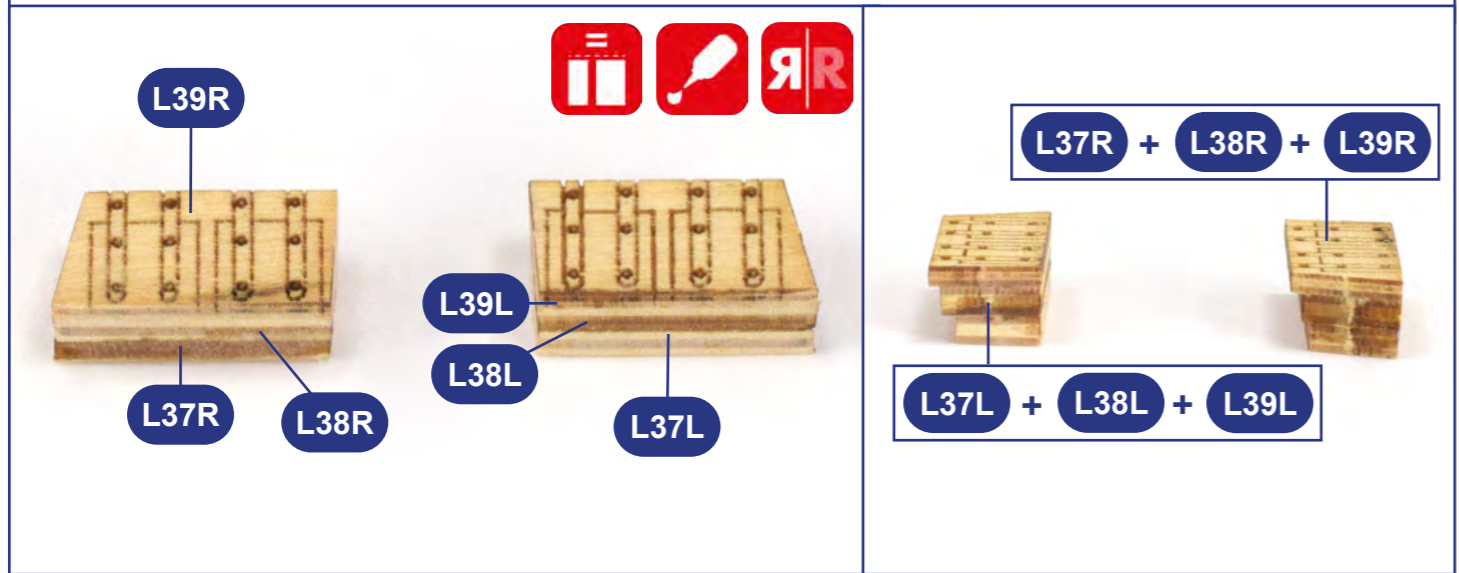
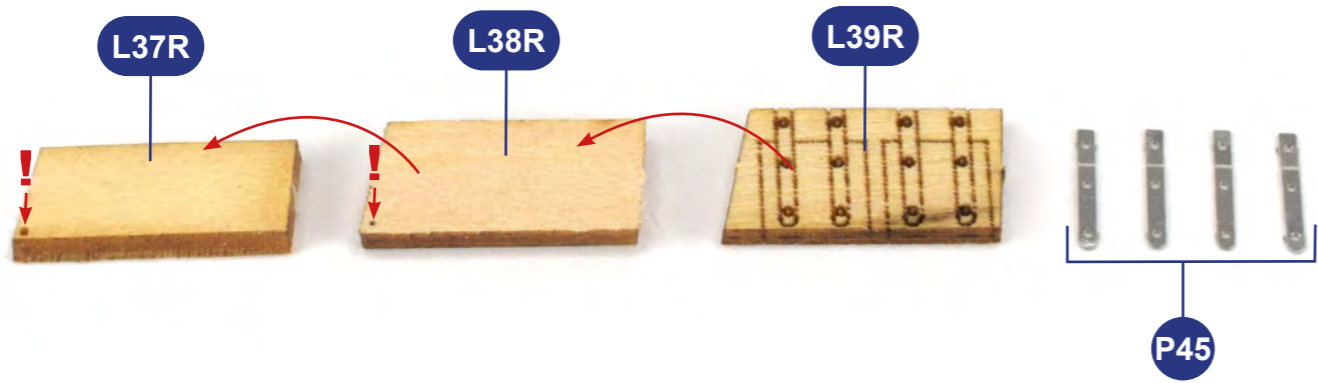

02

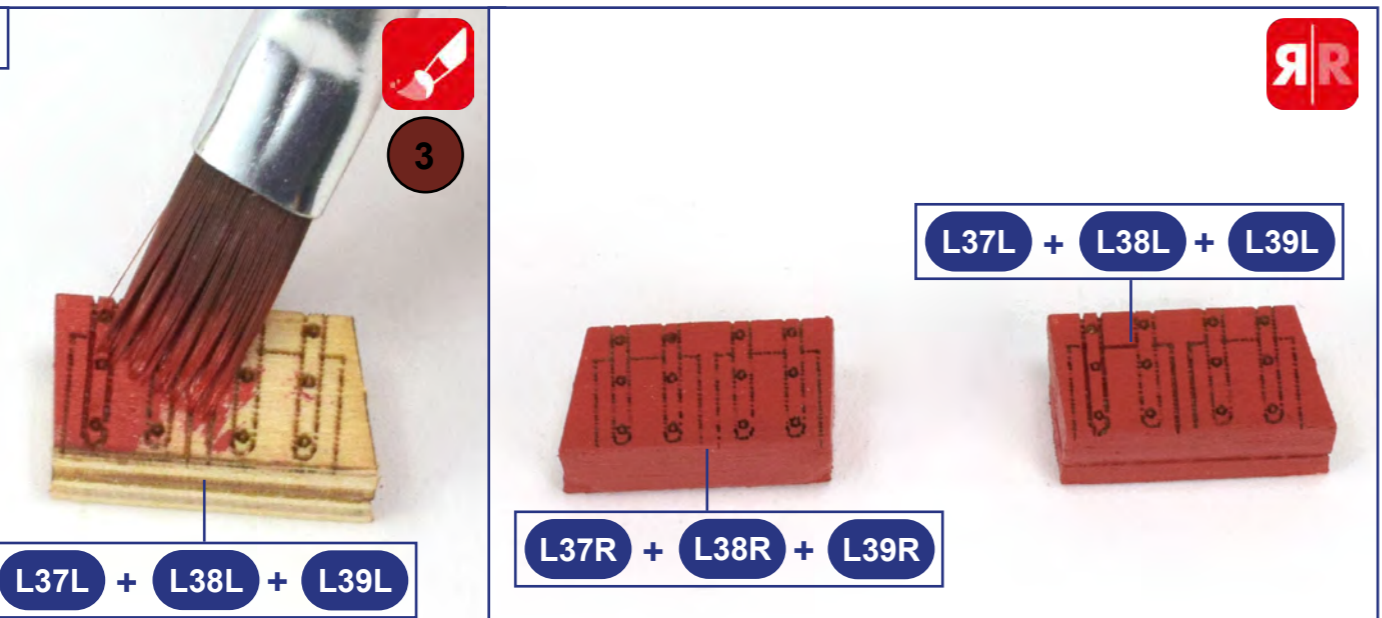

03

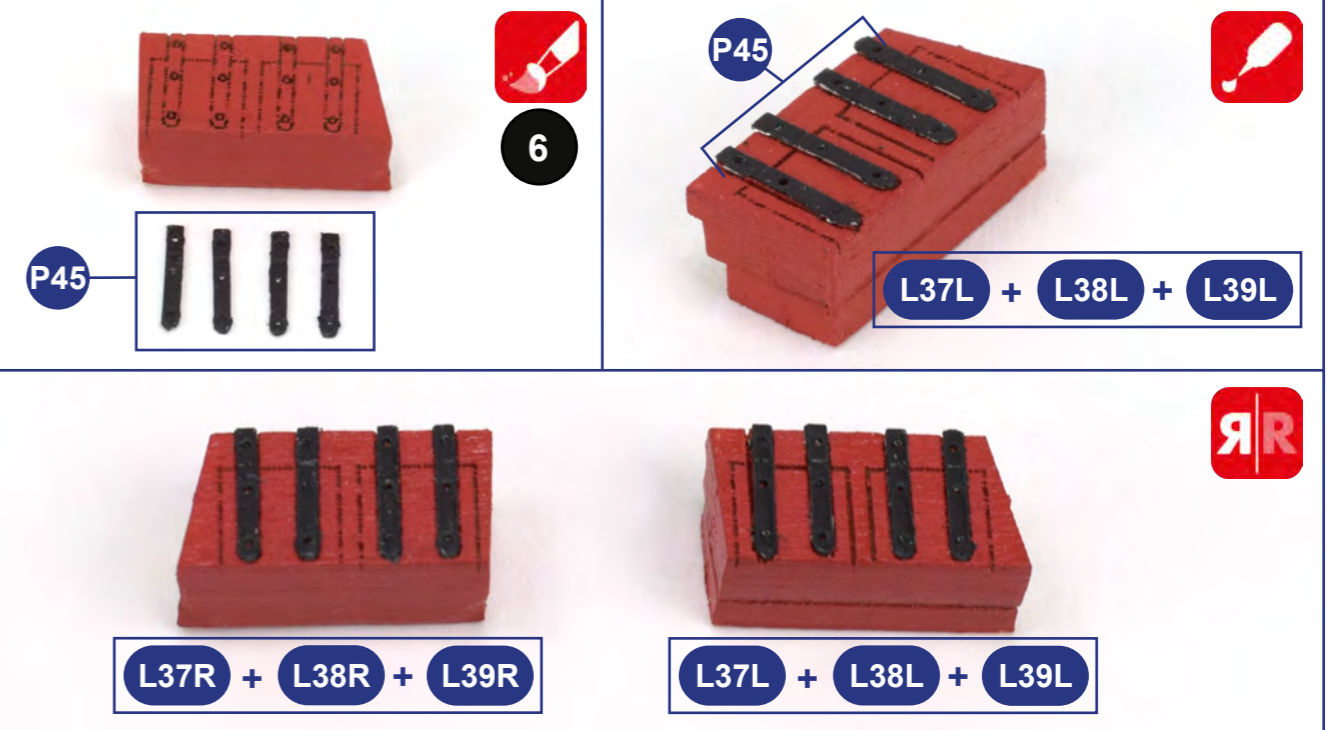

04

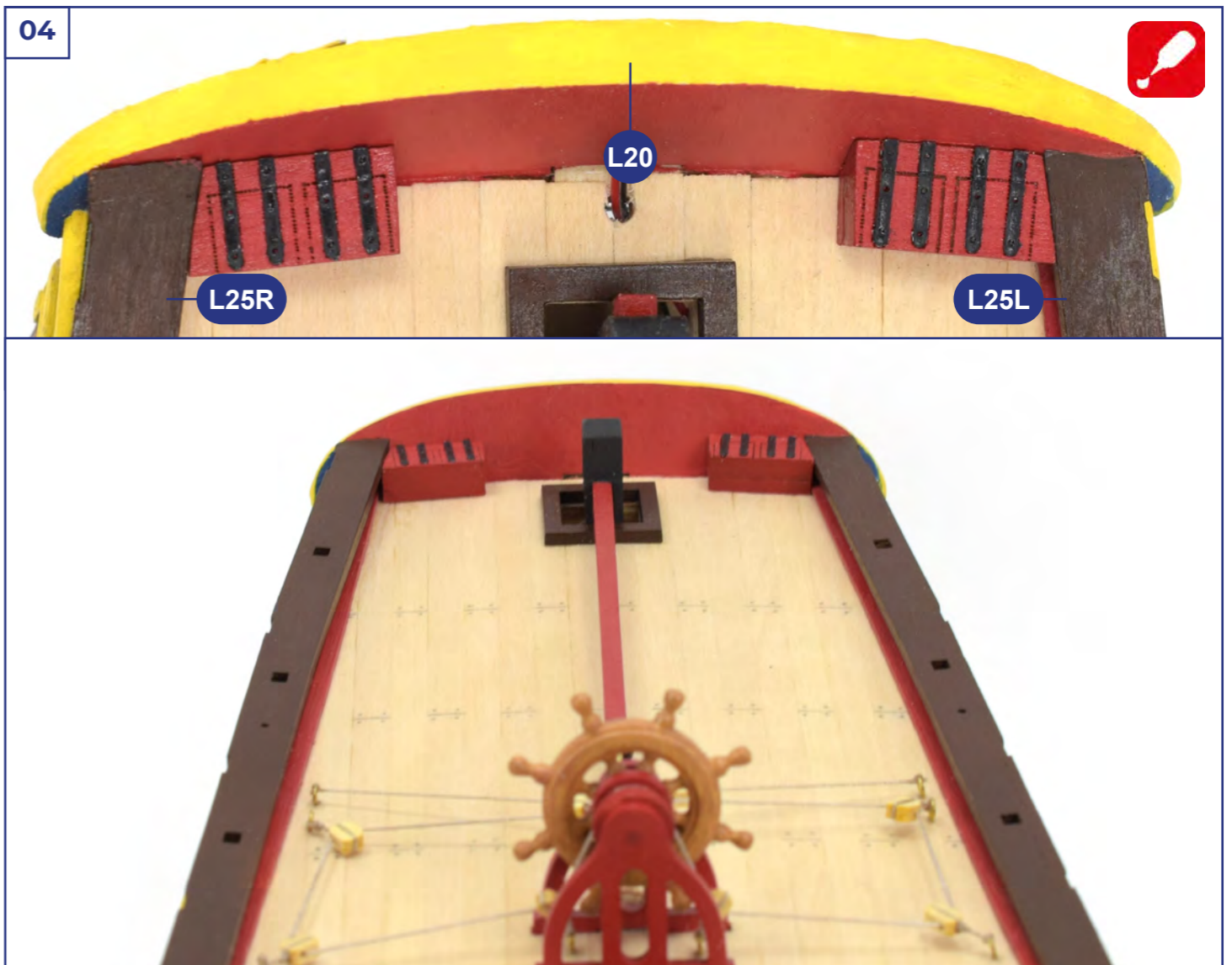

17

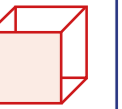
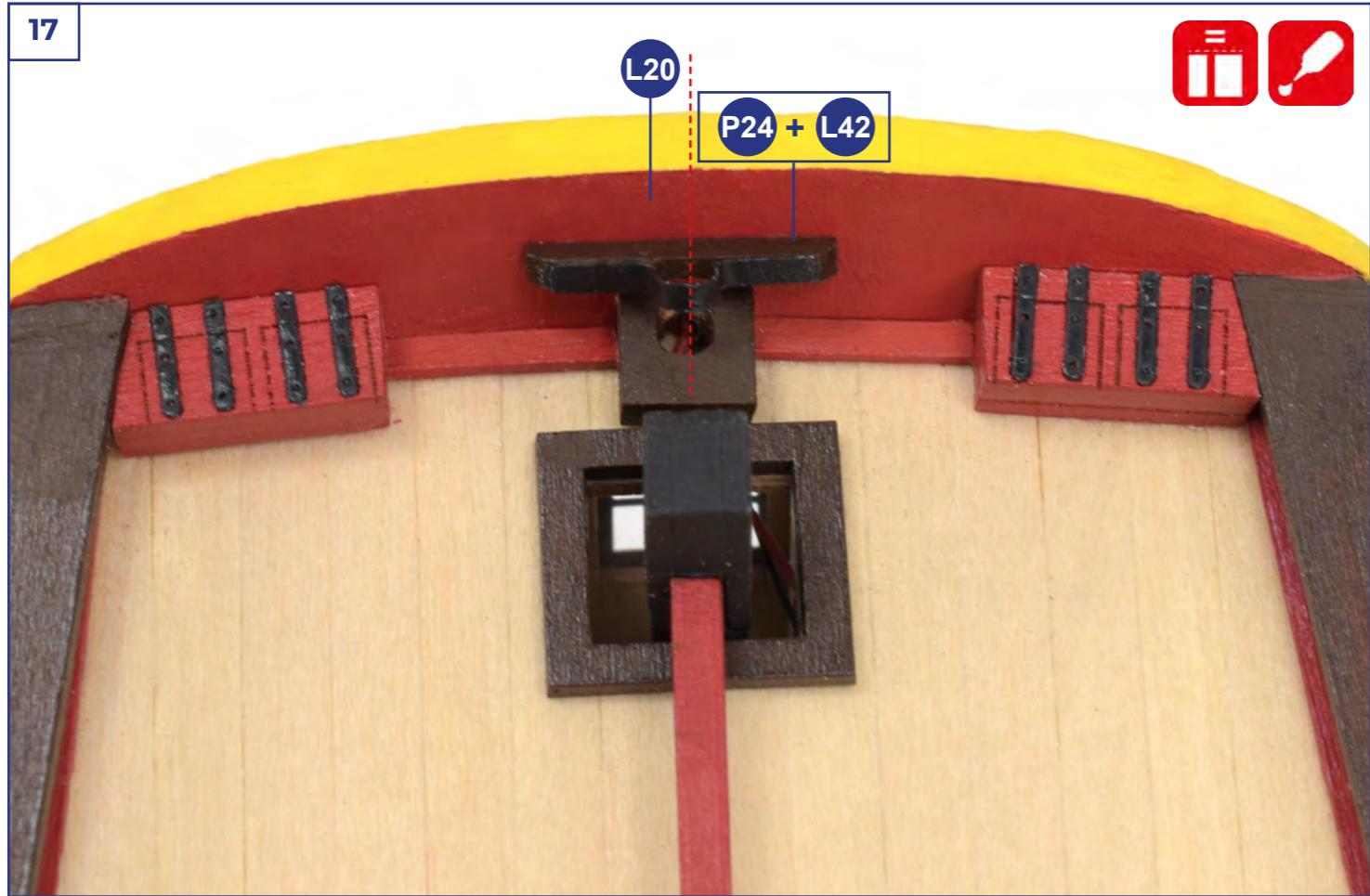

FRONT VIEW

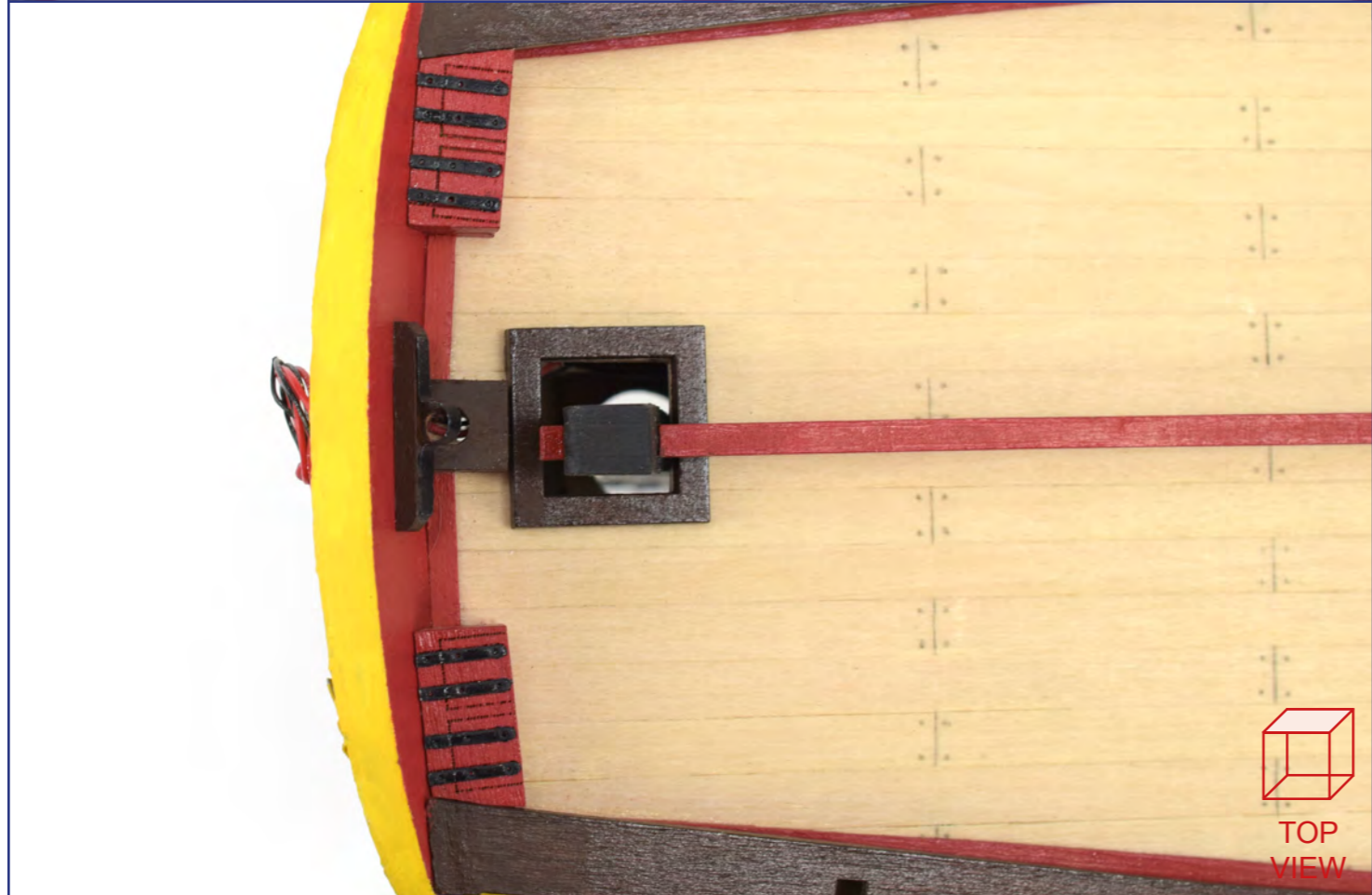

TOP VIEW

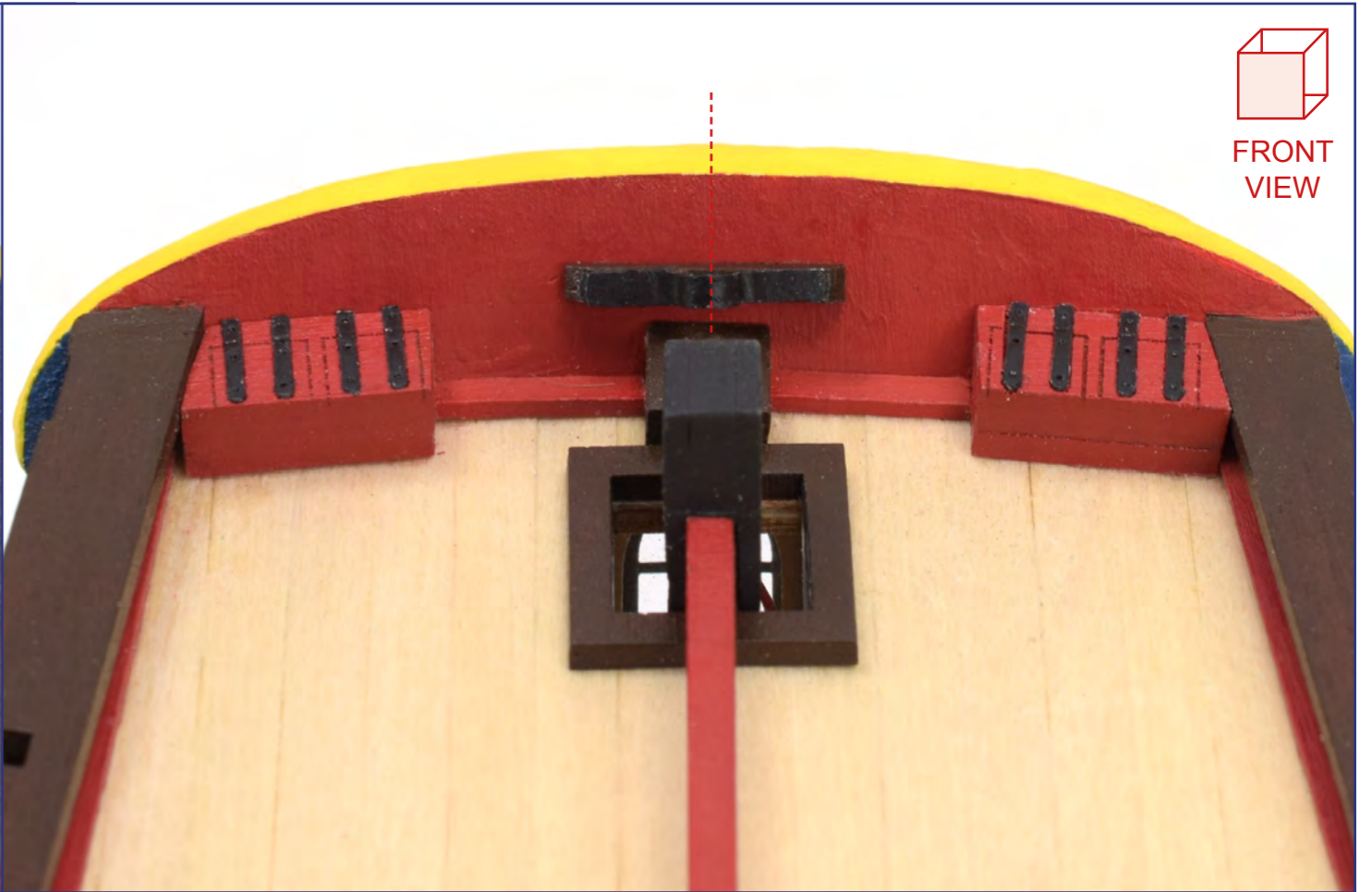

TOP VIEW

18



F3 60mm

19

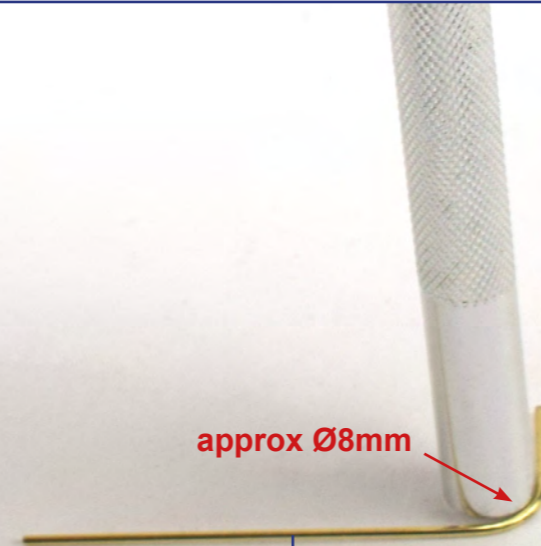

approx Ø8mm

F3

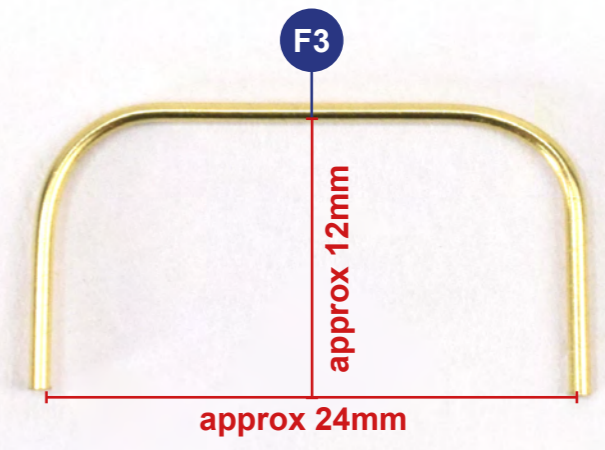

F3

approx 12mm

approx 24mm

20

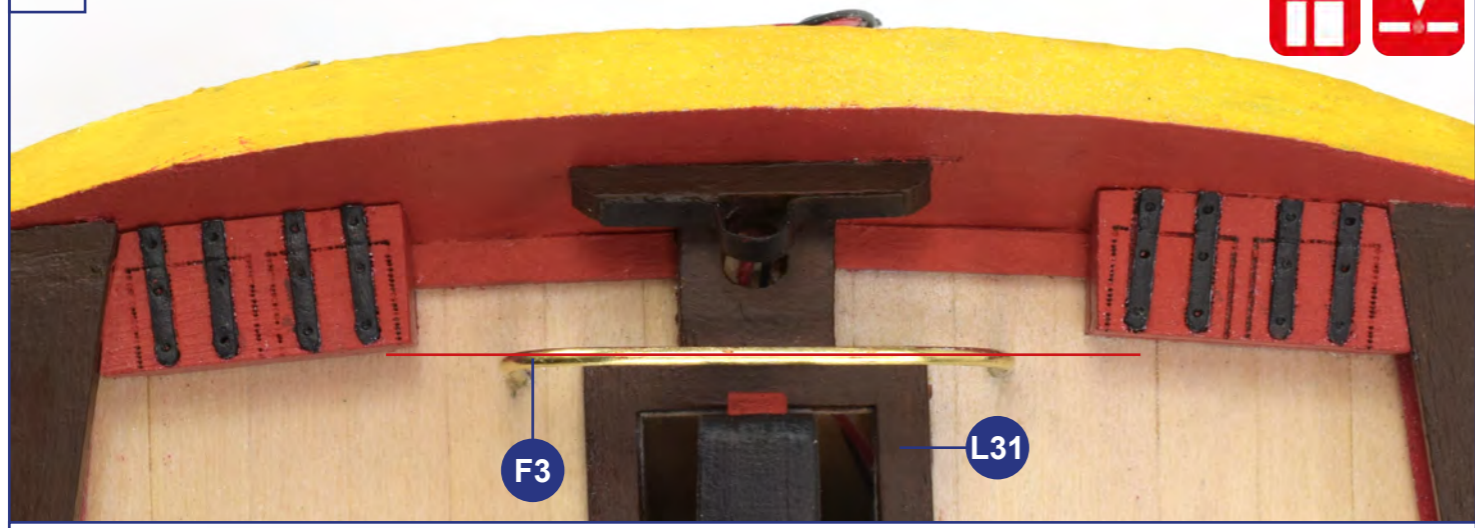

F3

L31

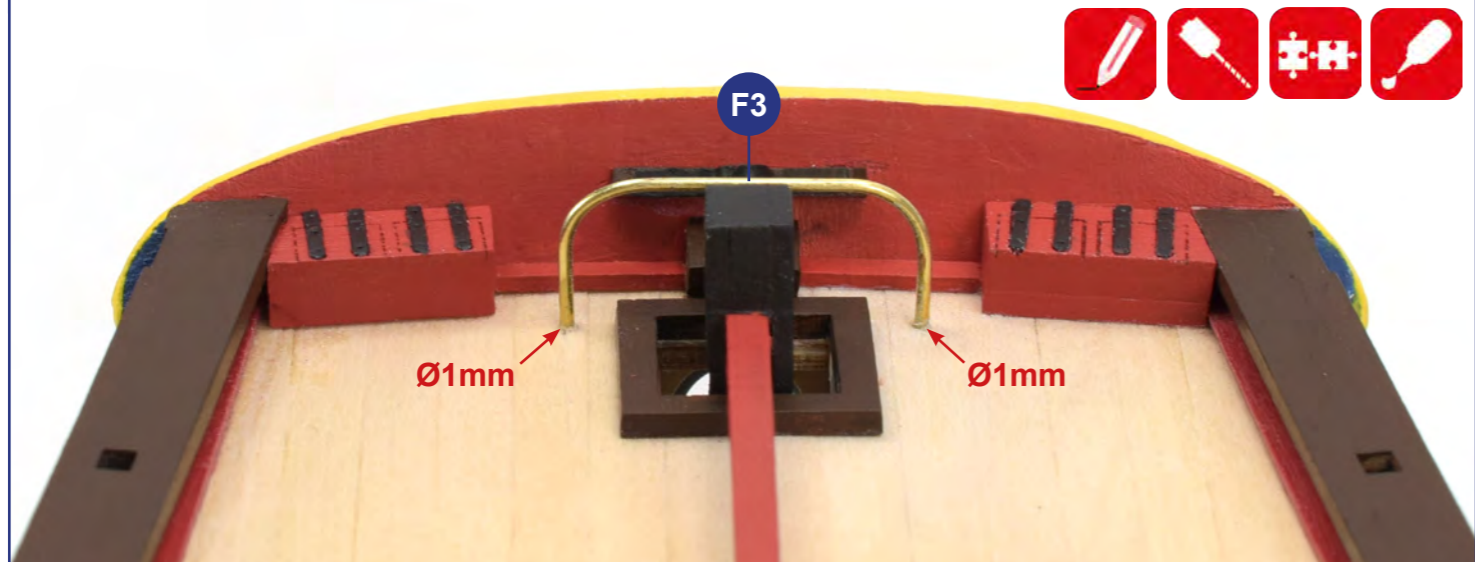

F3

Ø1mm

Ø1mm



21

L43 L44 L45

L43 L44 L45

L43 L44 L45

L43 L44 L45

L43 L44 L45

R

22

L43 + L44 + L45

WS12 45mm

L43 + L44 + L45

WS12

23

WV1 15mm

24

L43 + L44 + L45 + WS12

3

FRONT VIEW

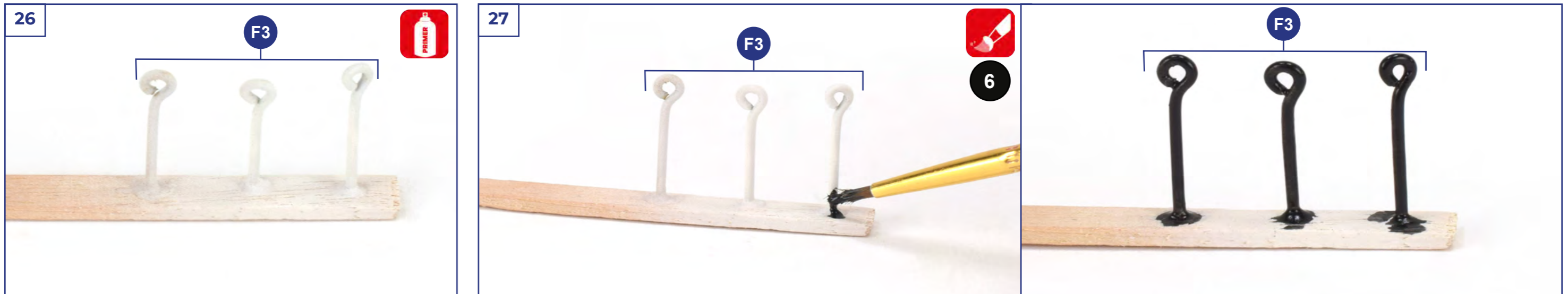
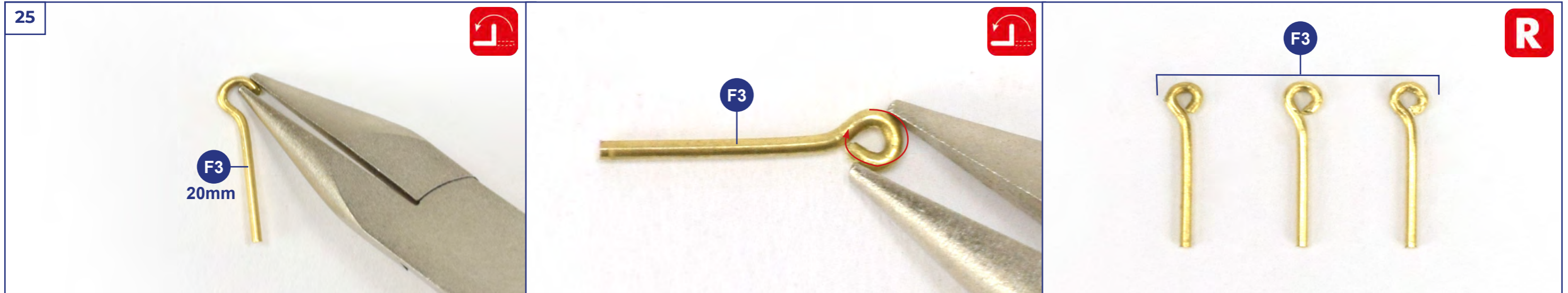

30

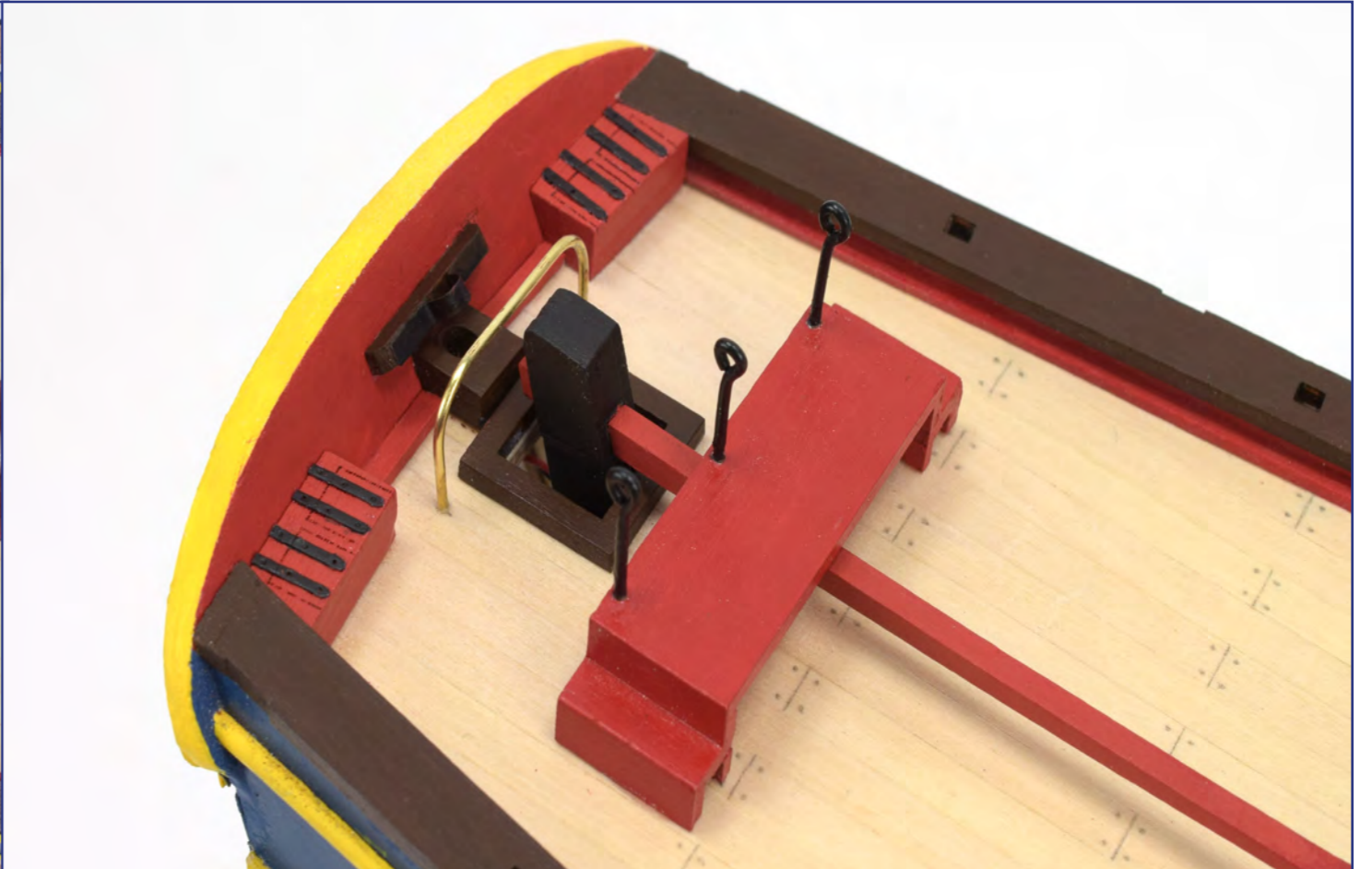

31

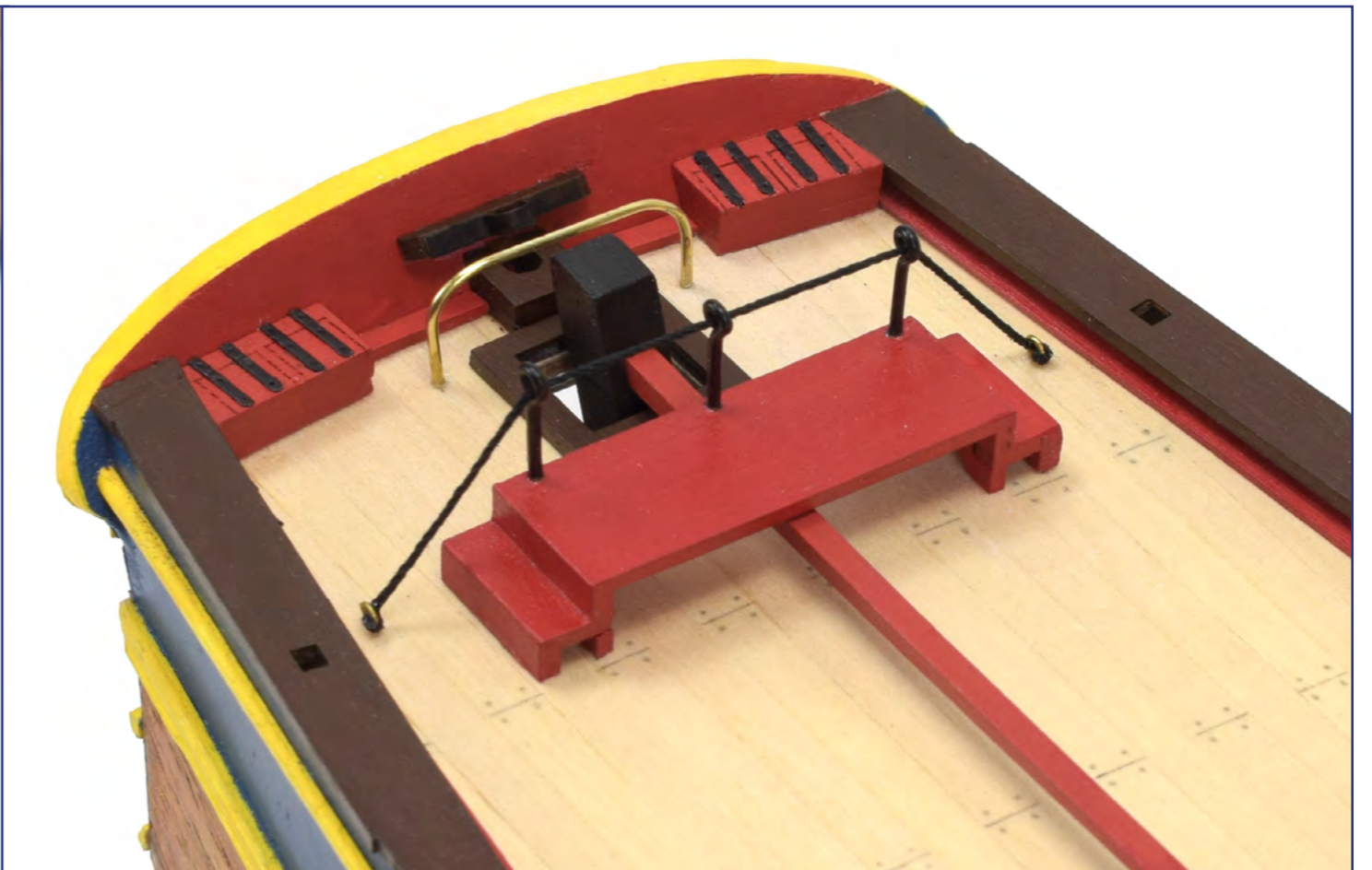
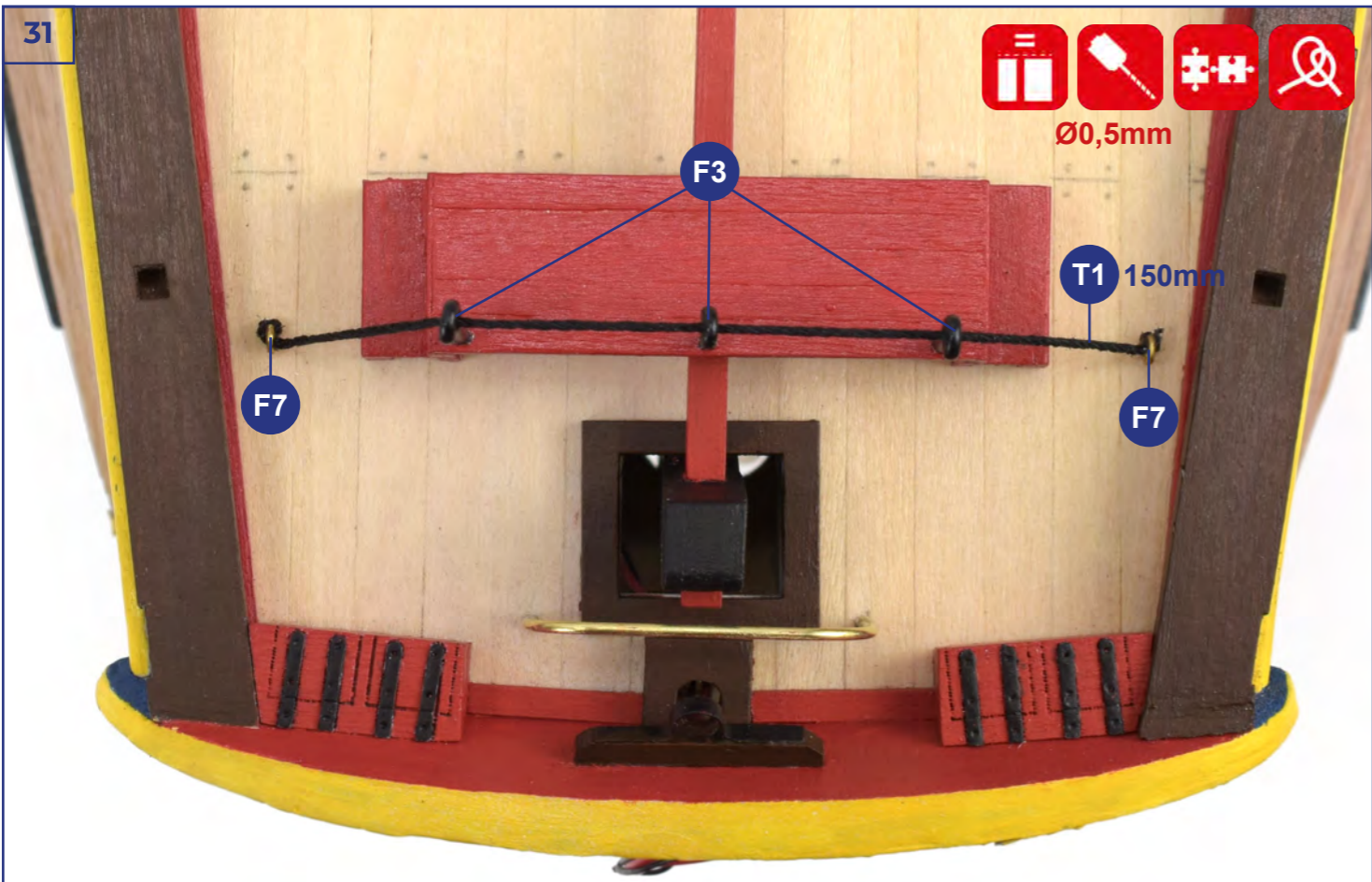

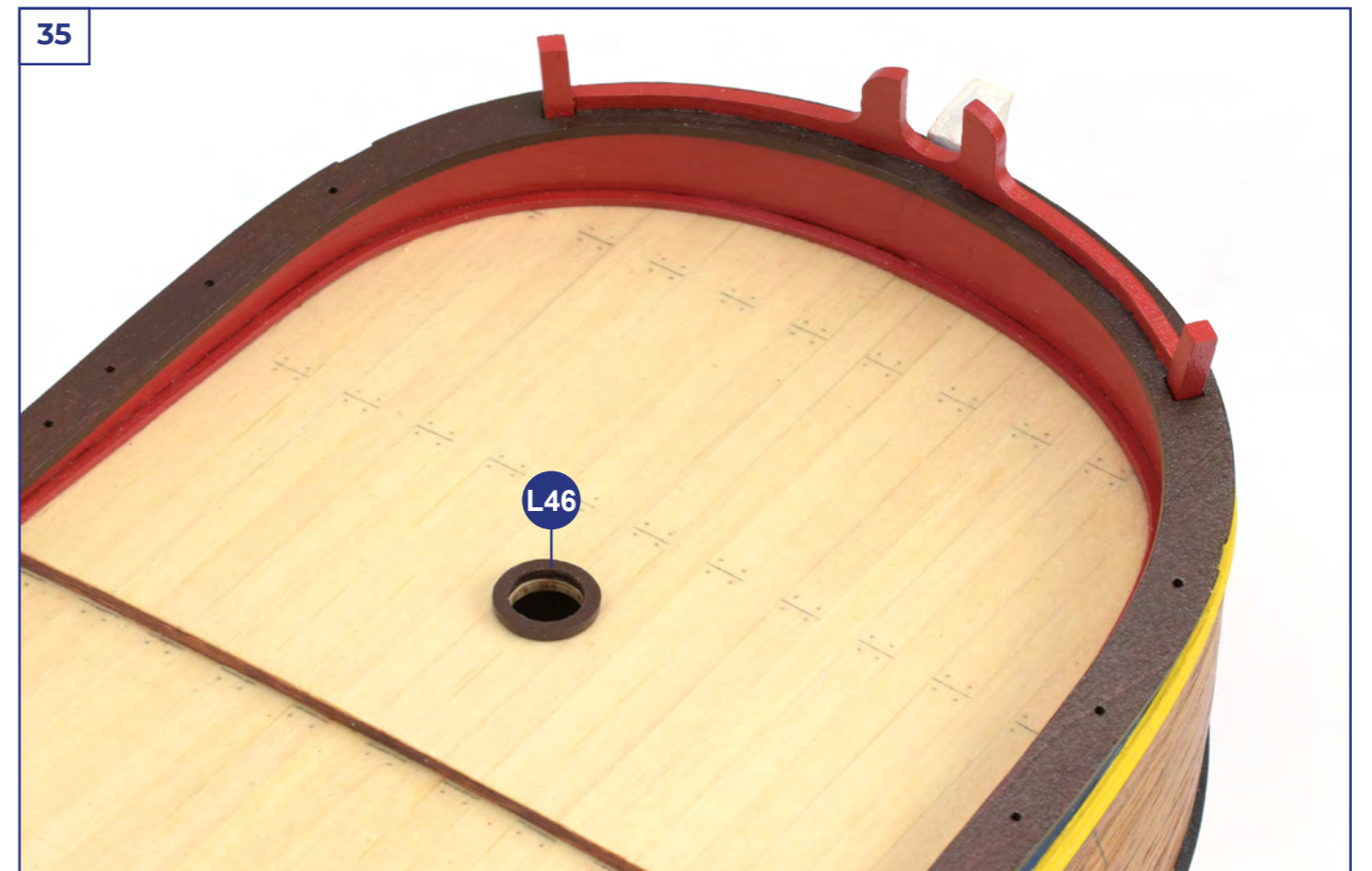
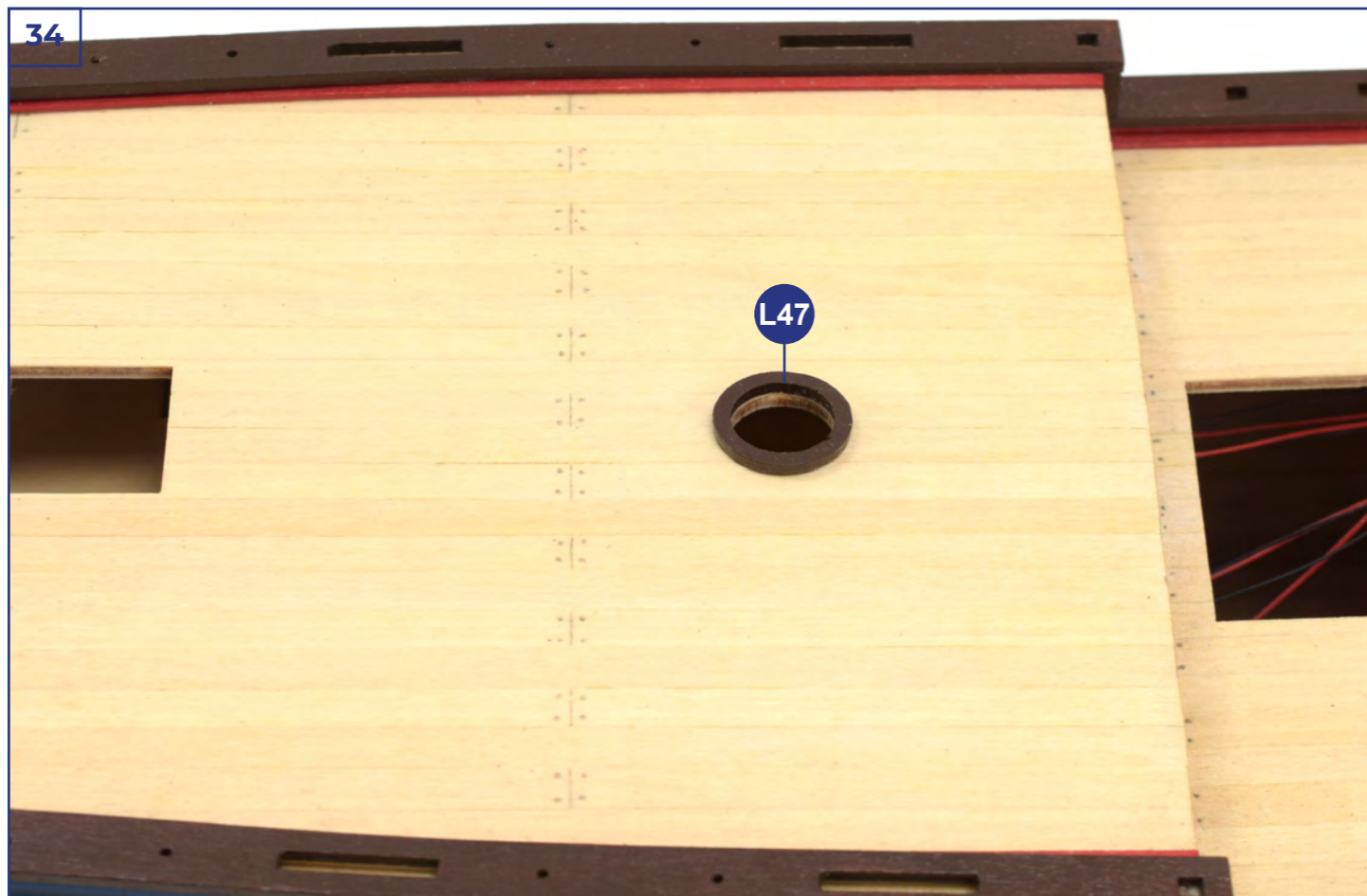
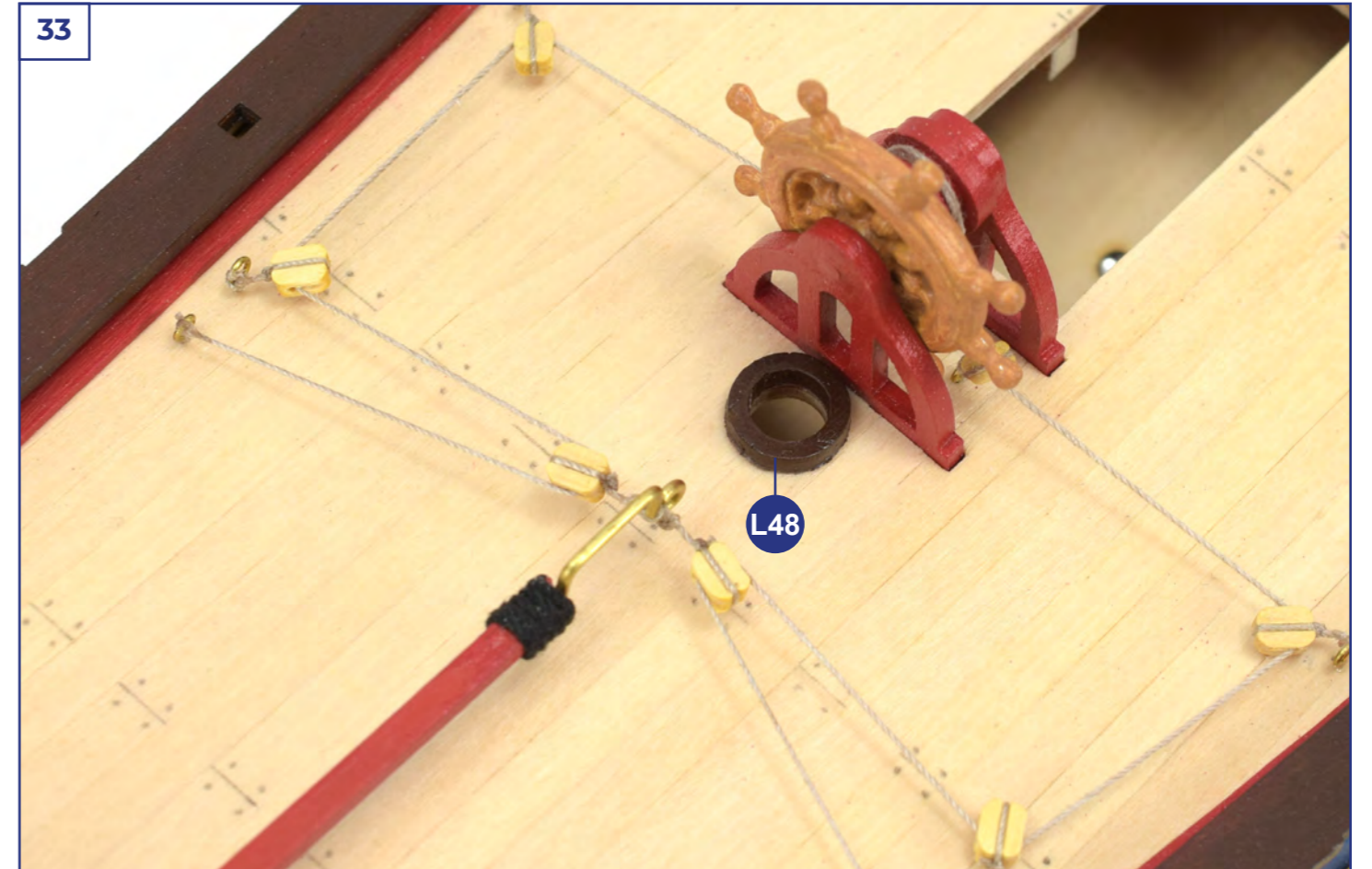
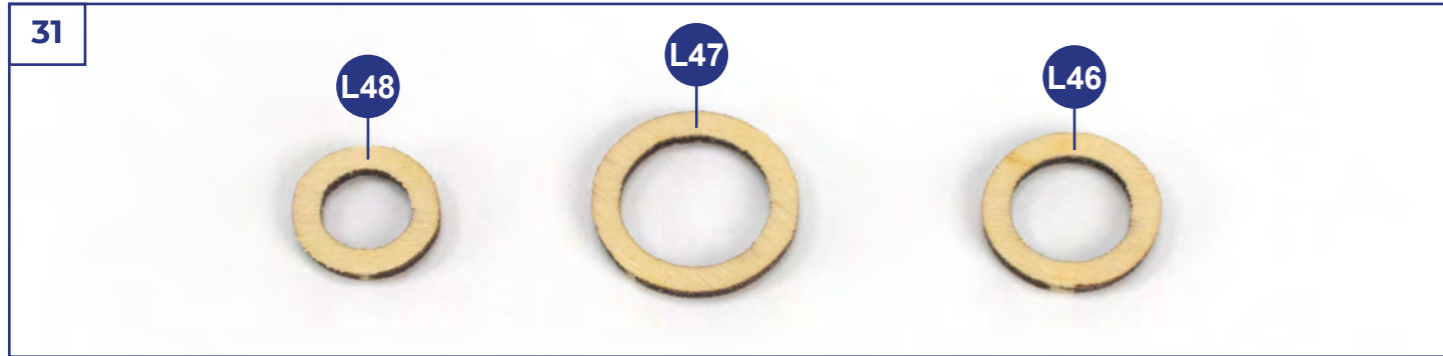

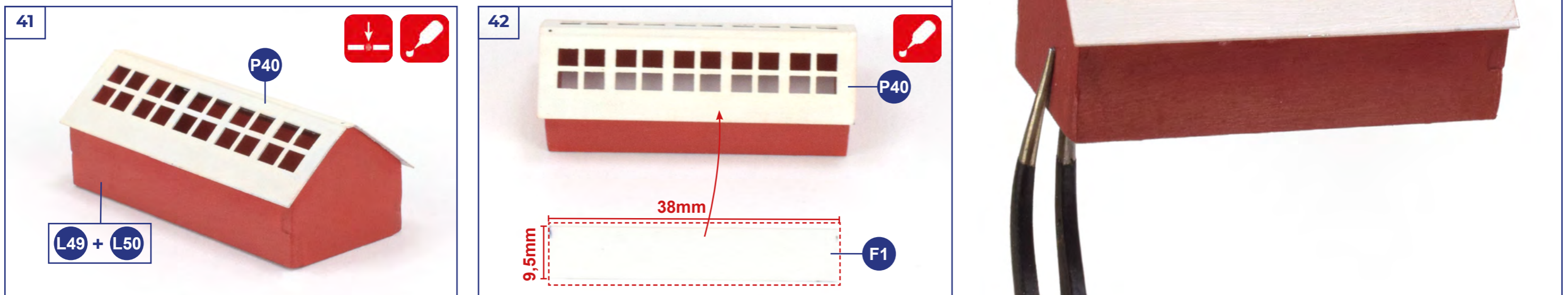
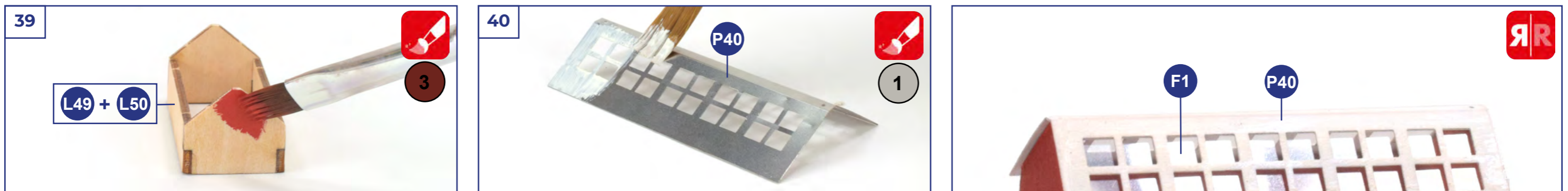
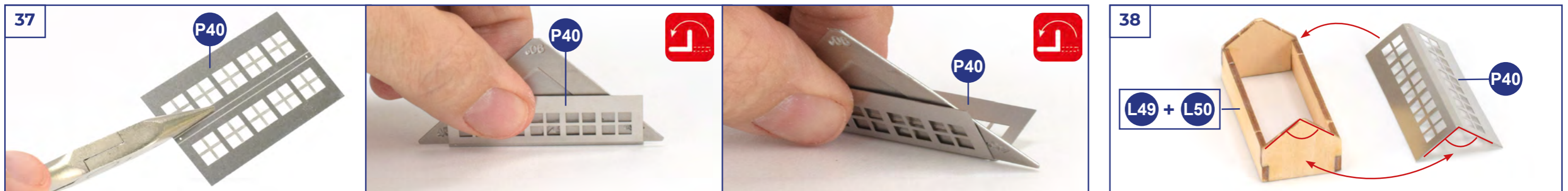
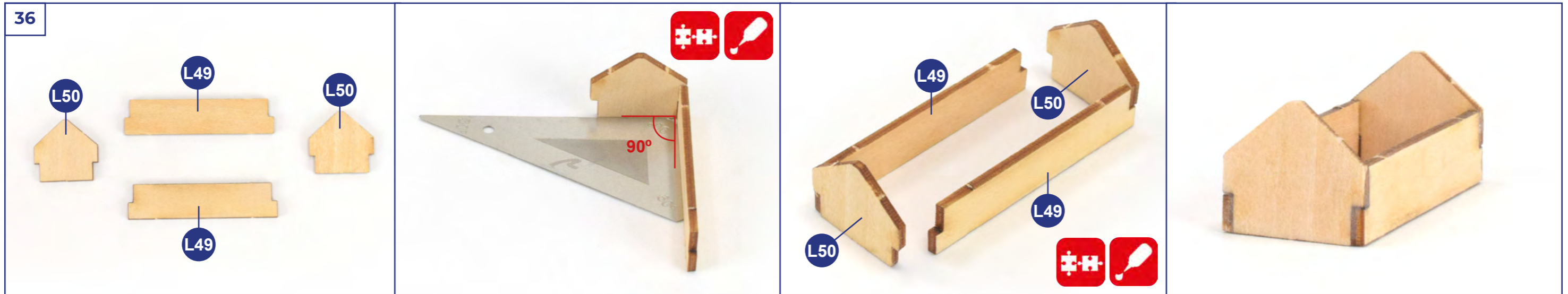

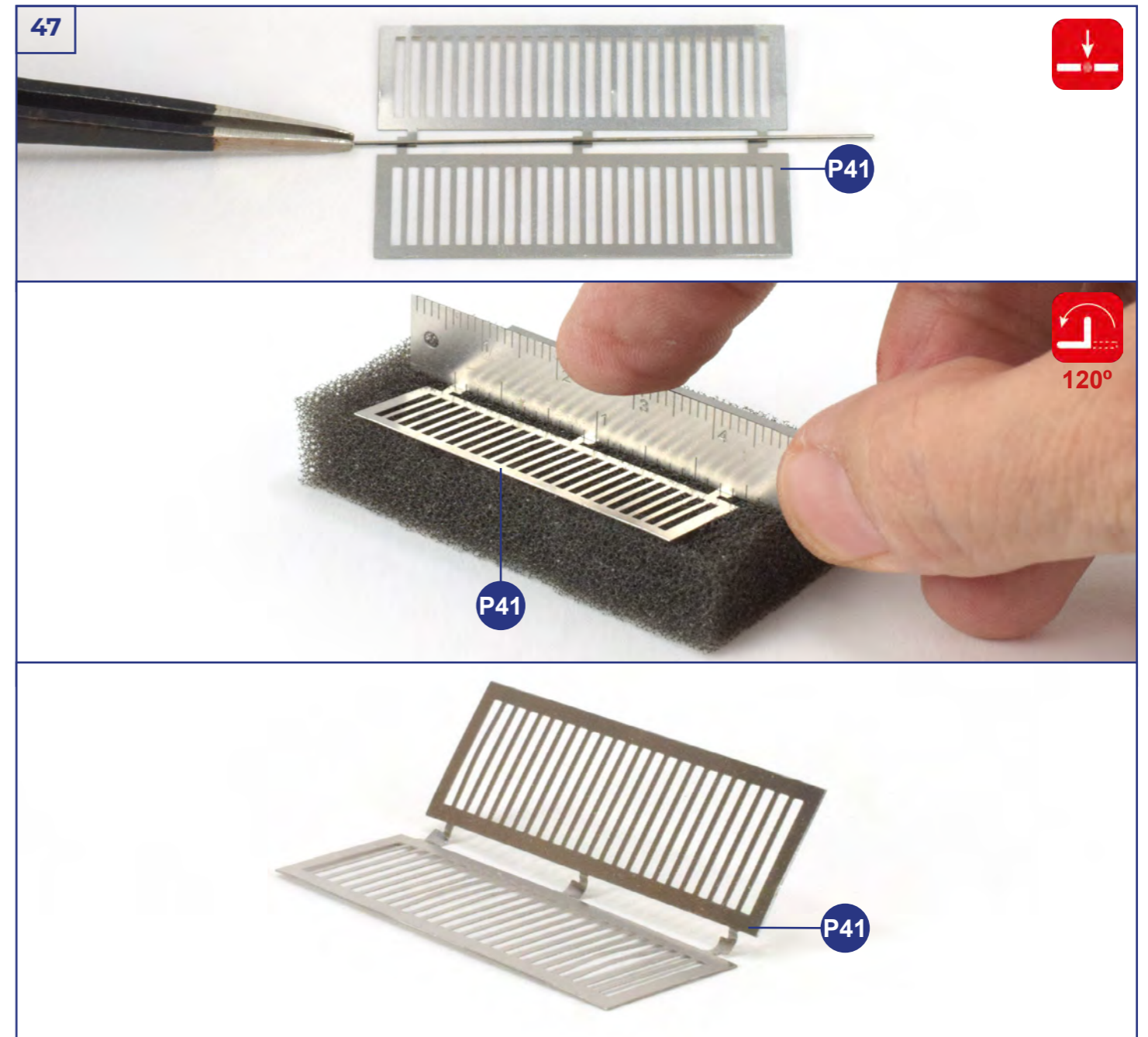
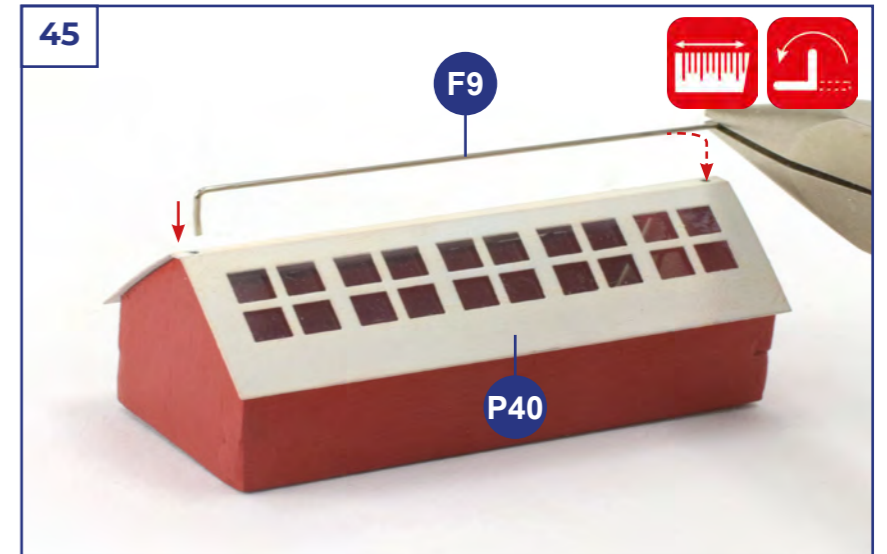
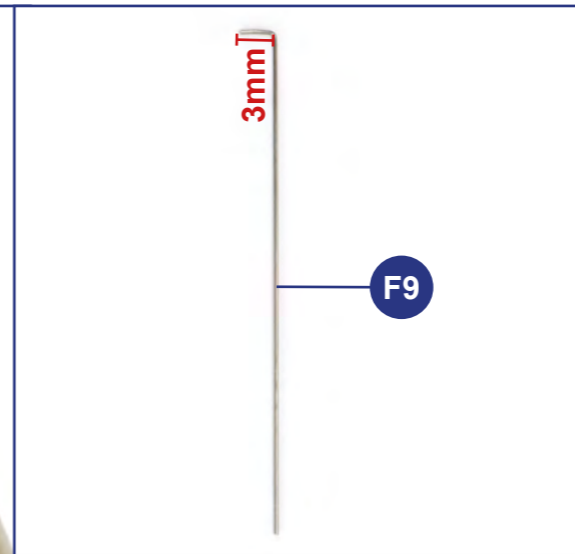
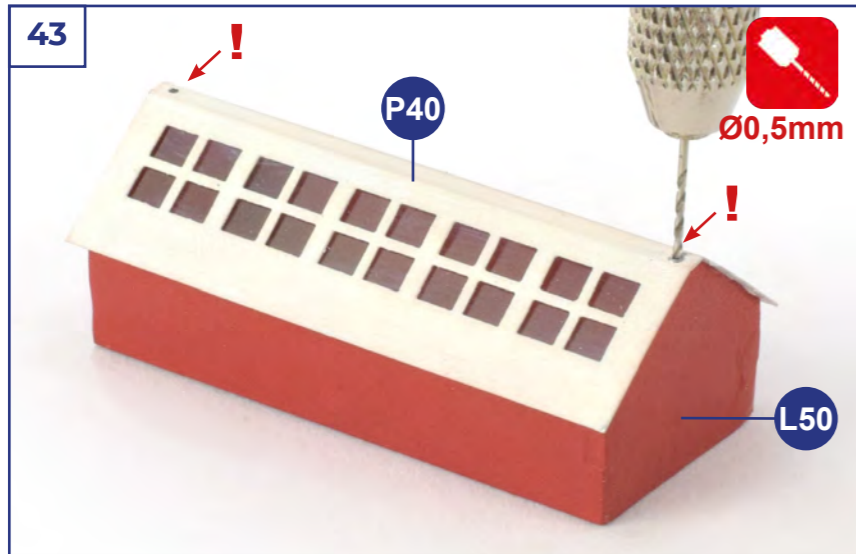

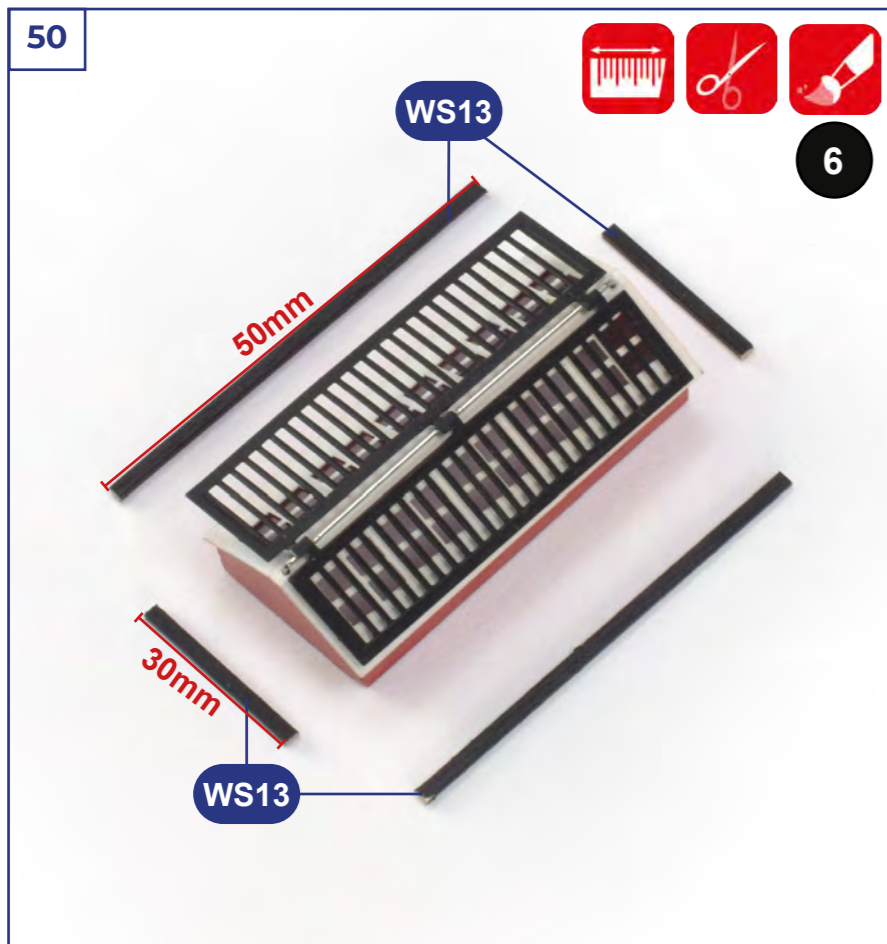
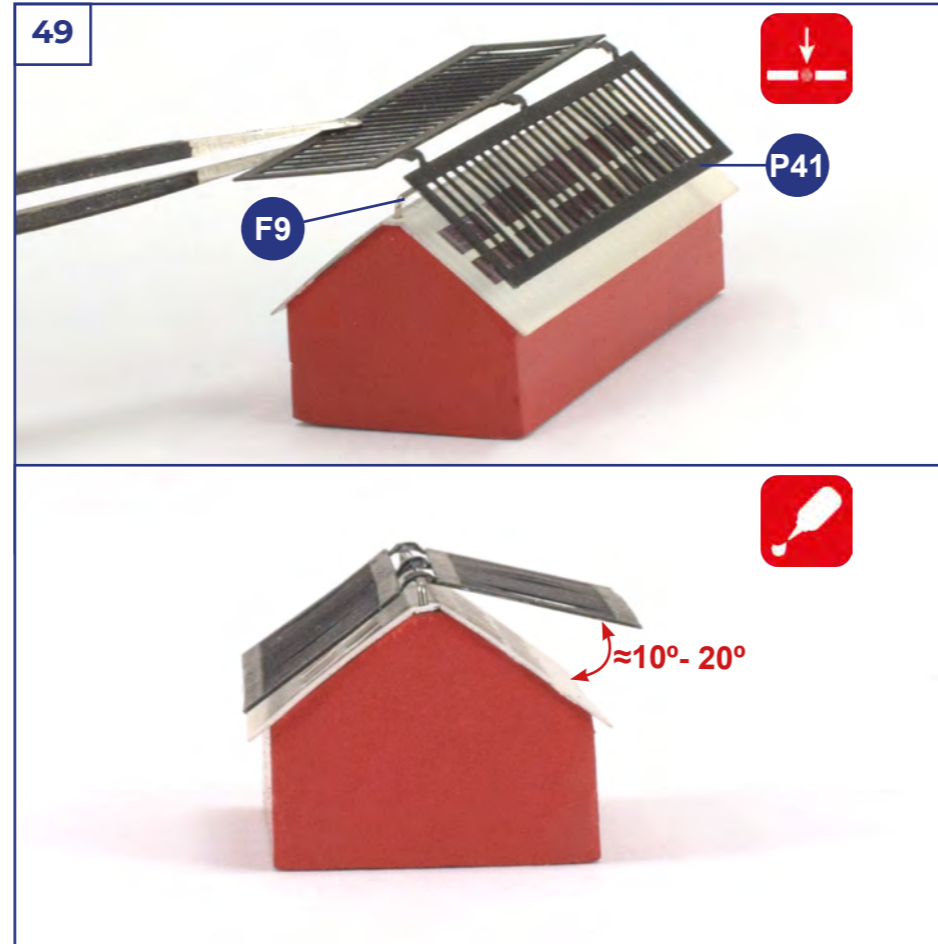
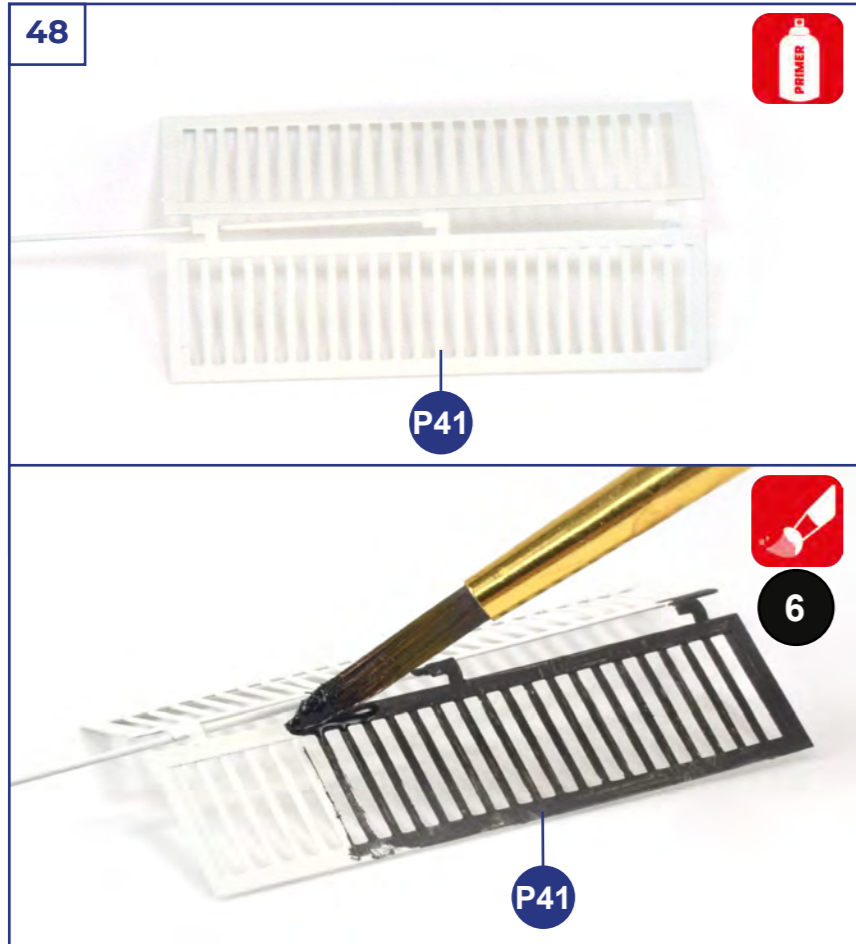

51

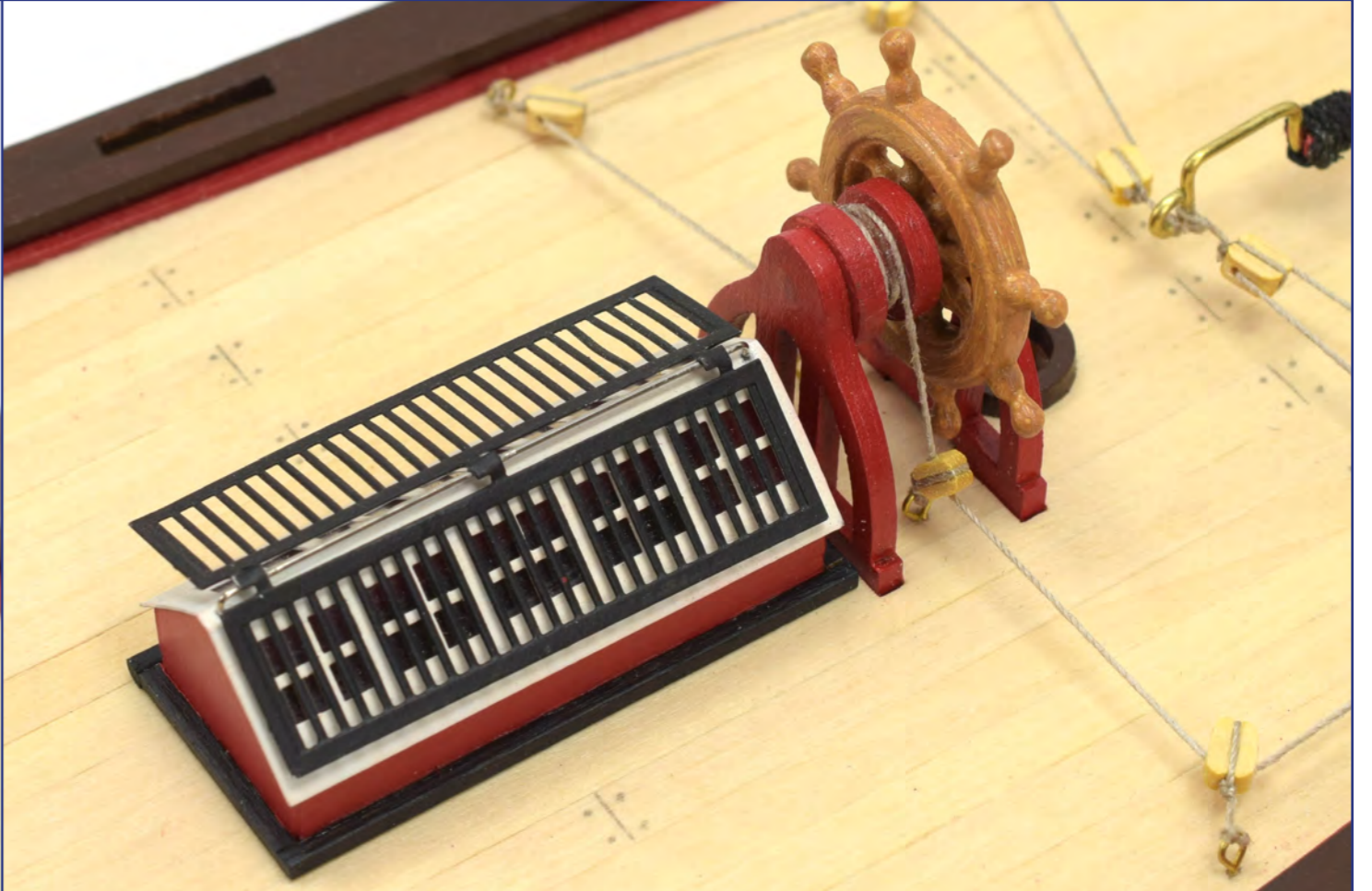
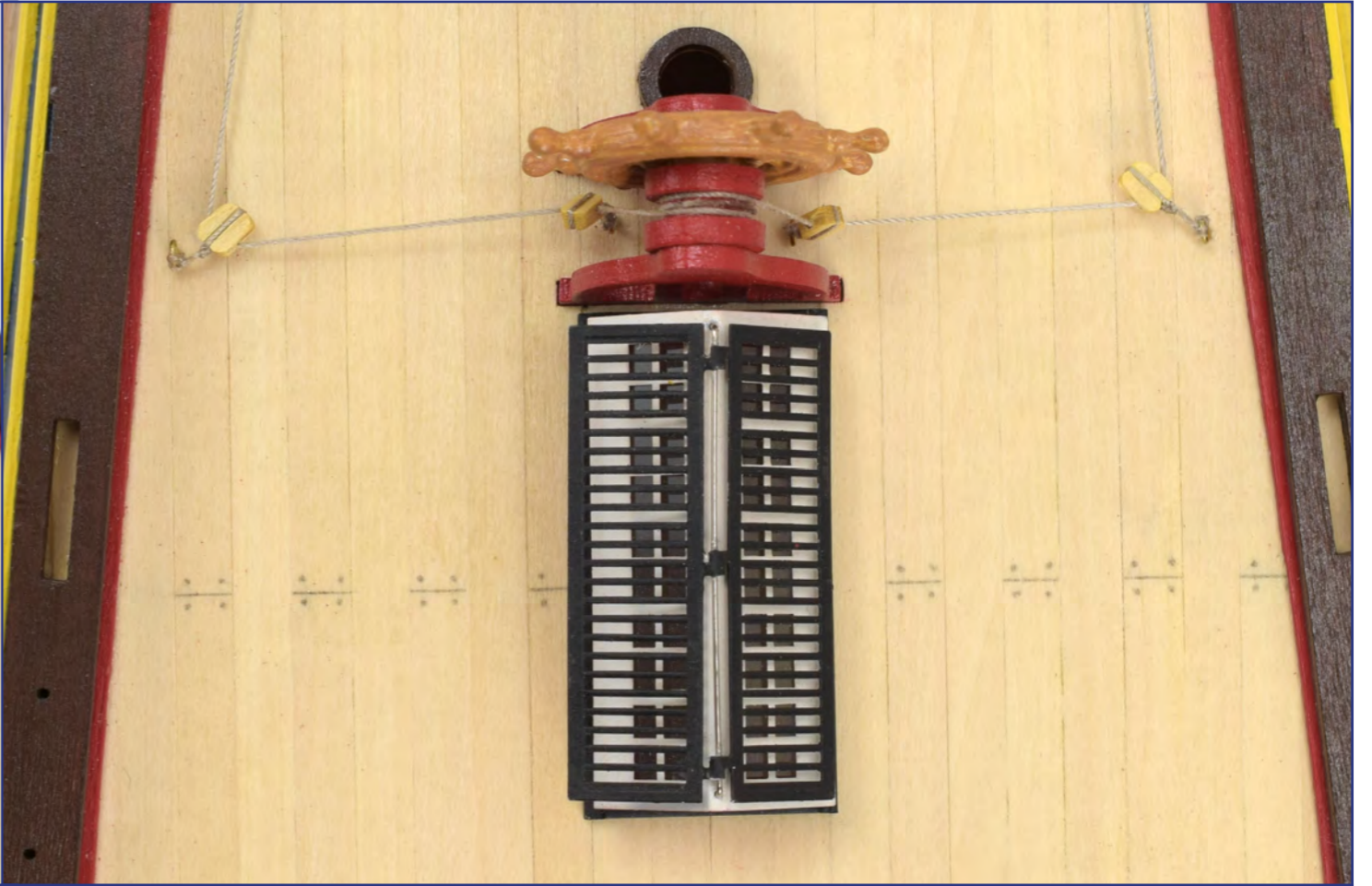
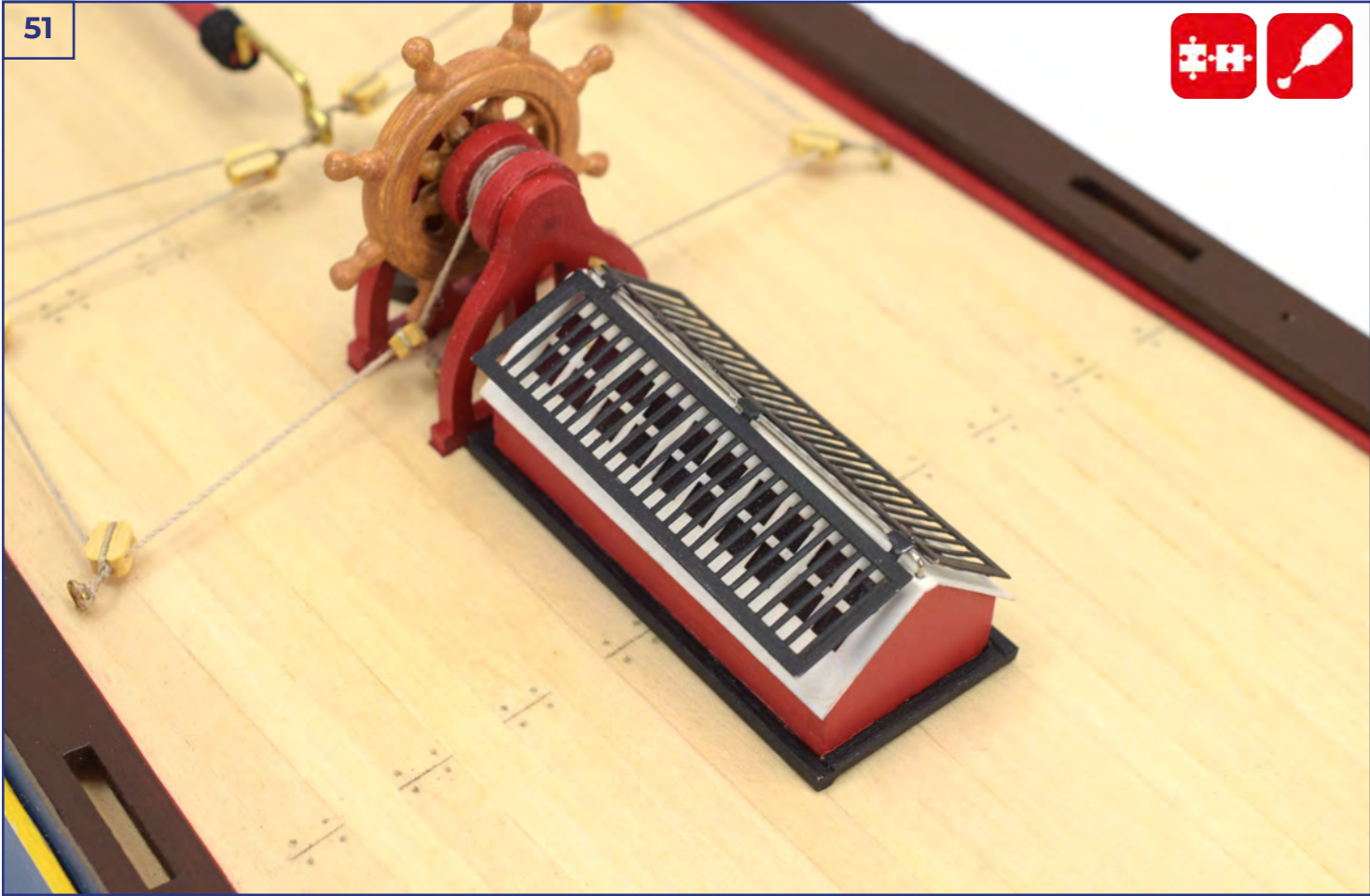

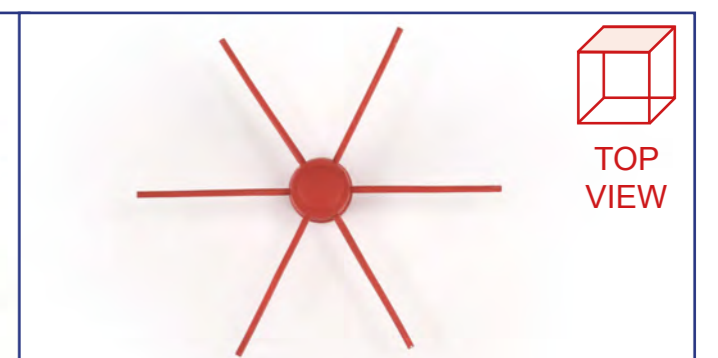
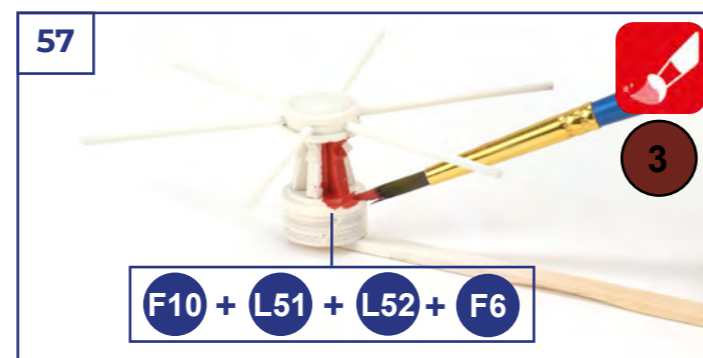
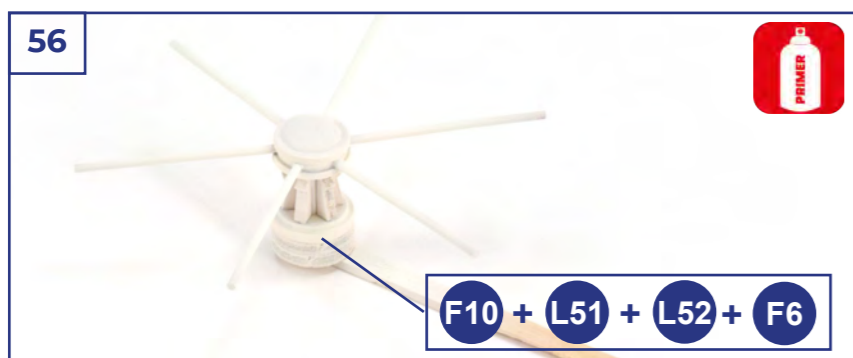
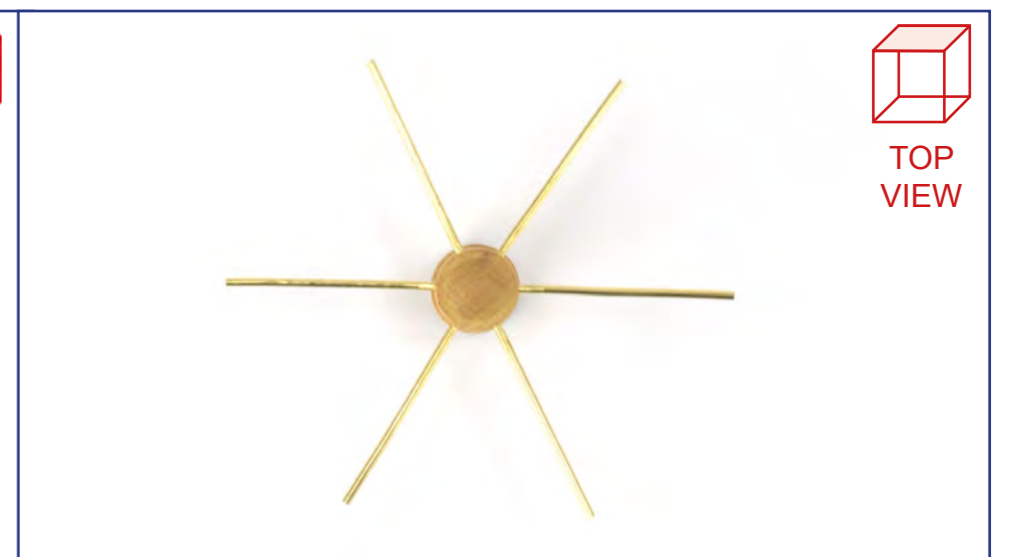
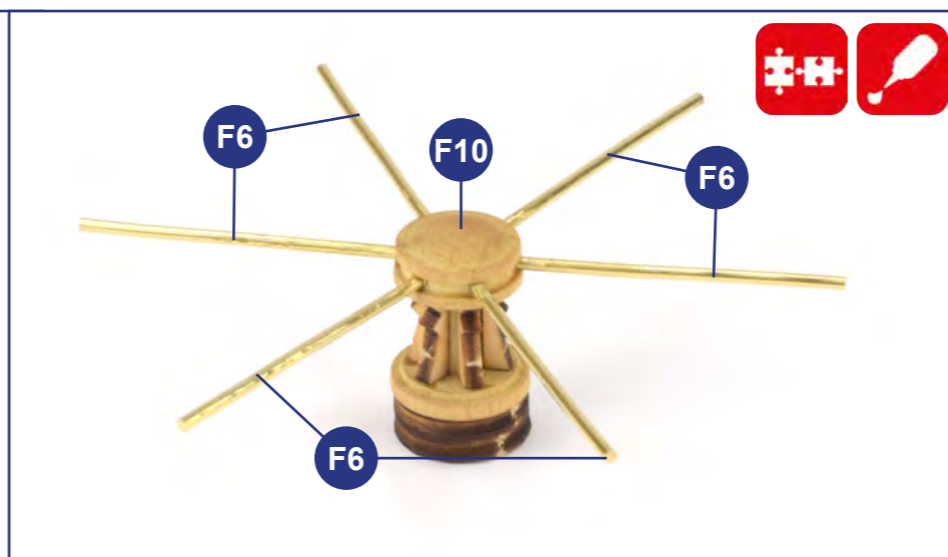
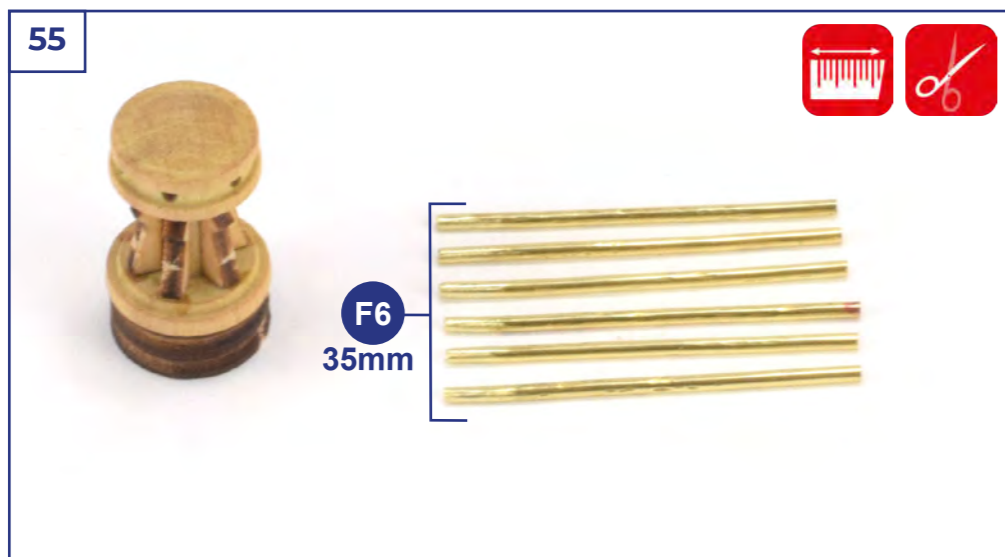
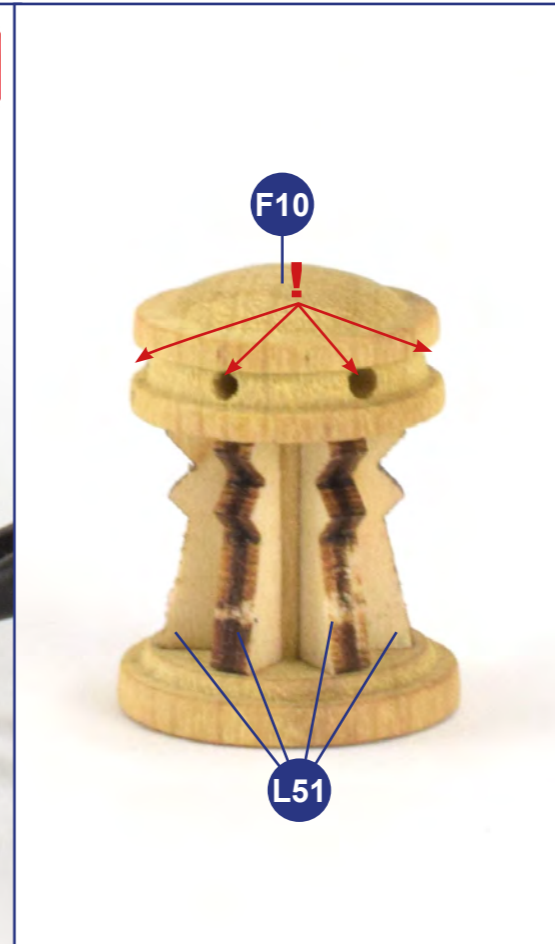
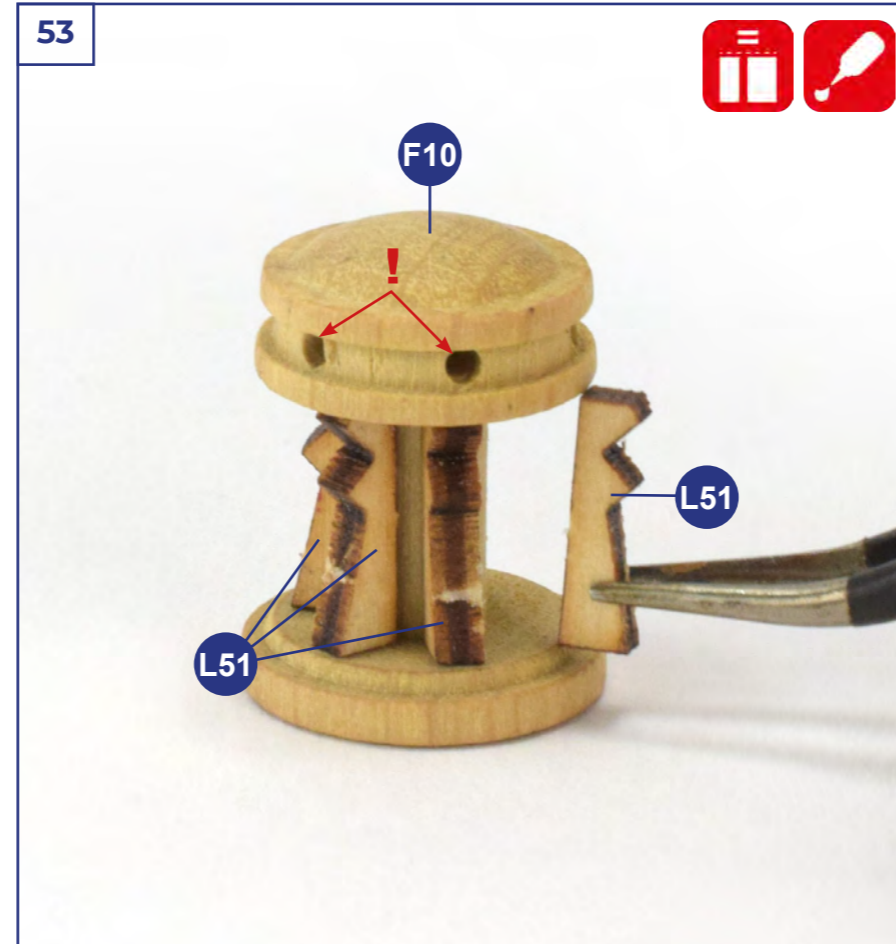
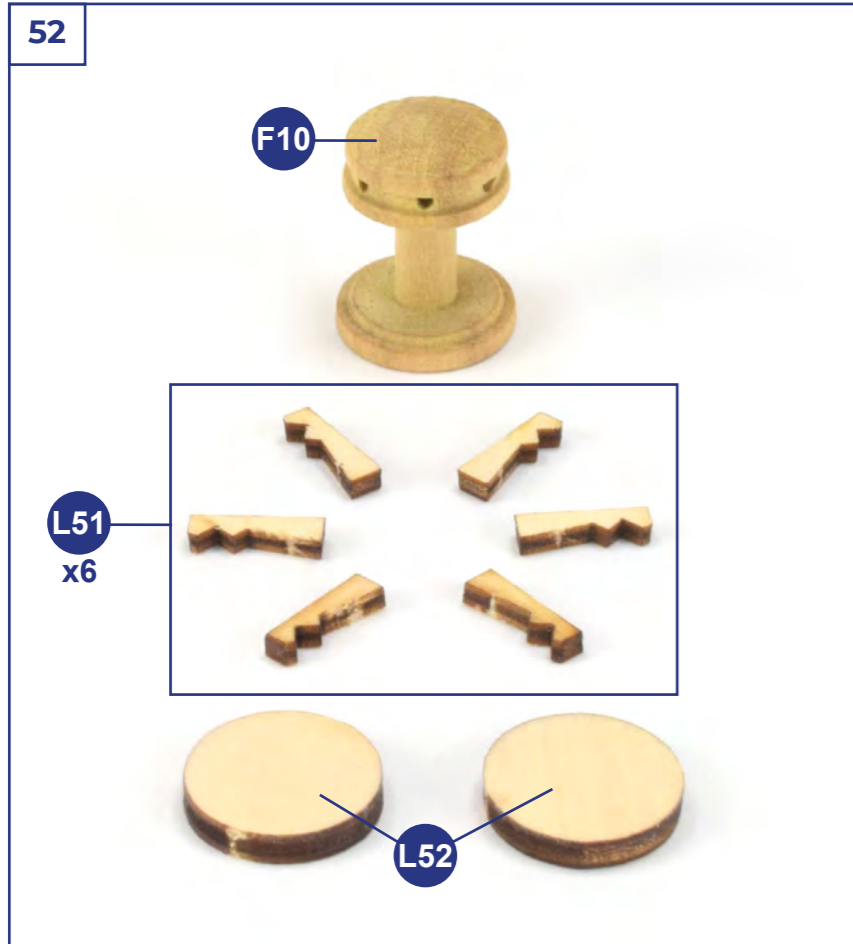

58



F10 + L51 + L52 + F6

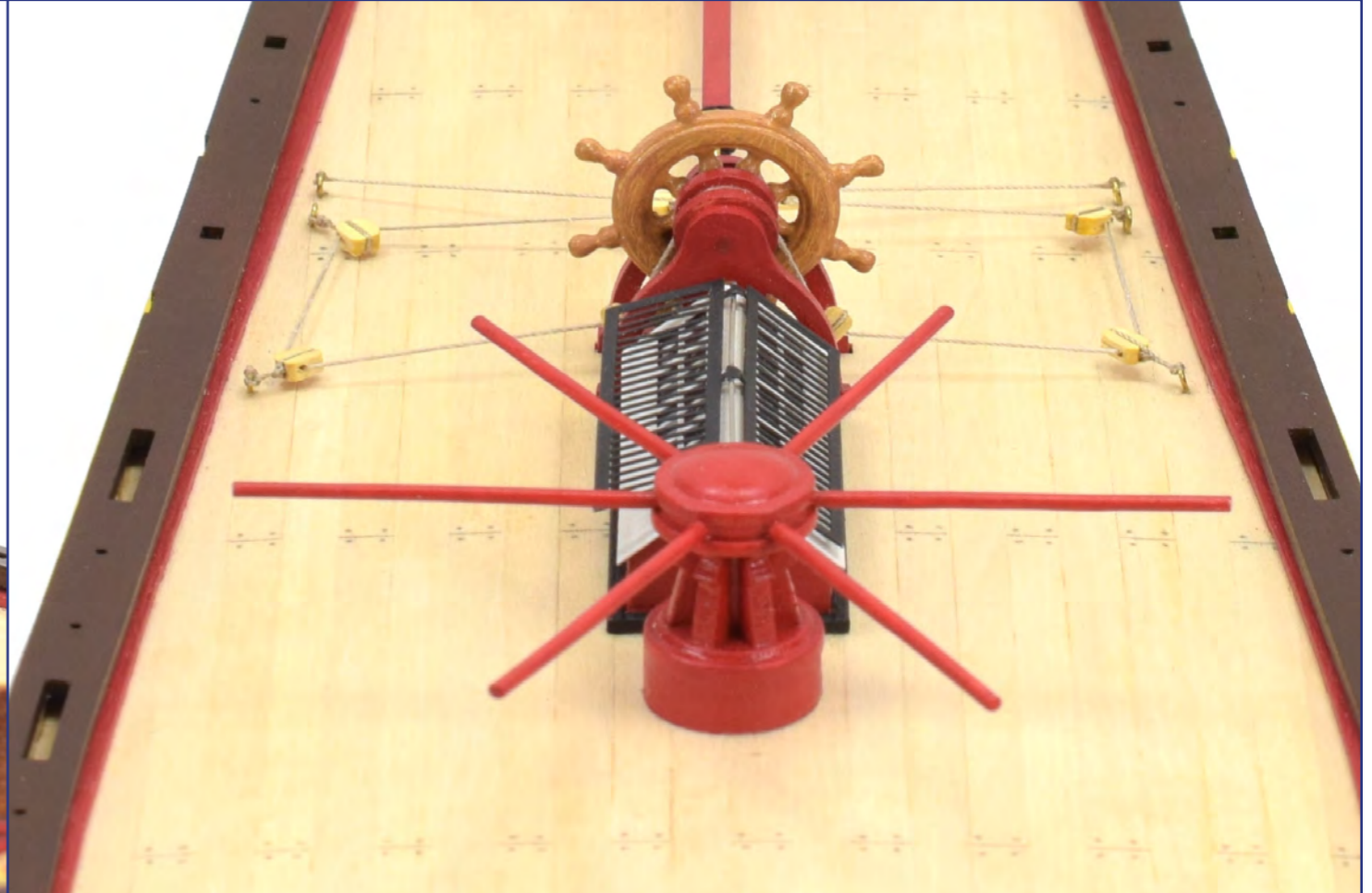
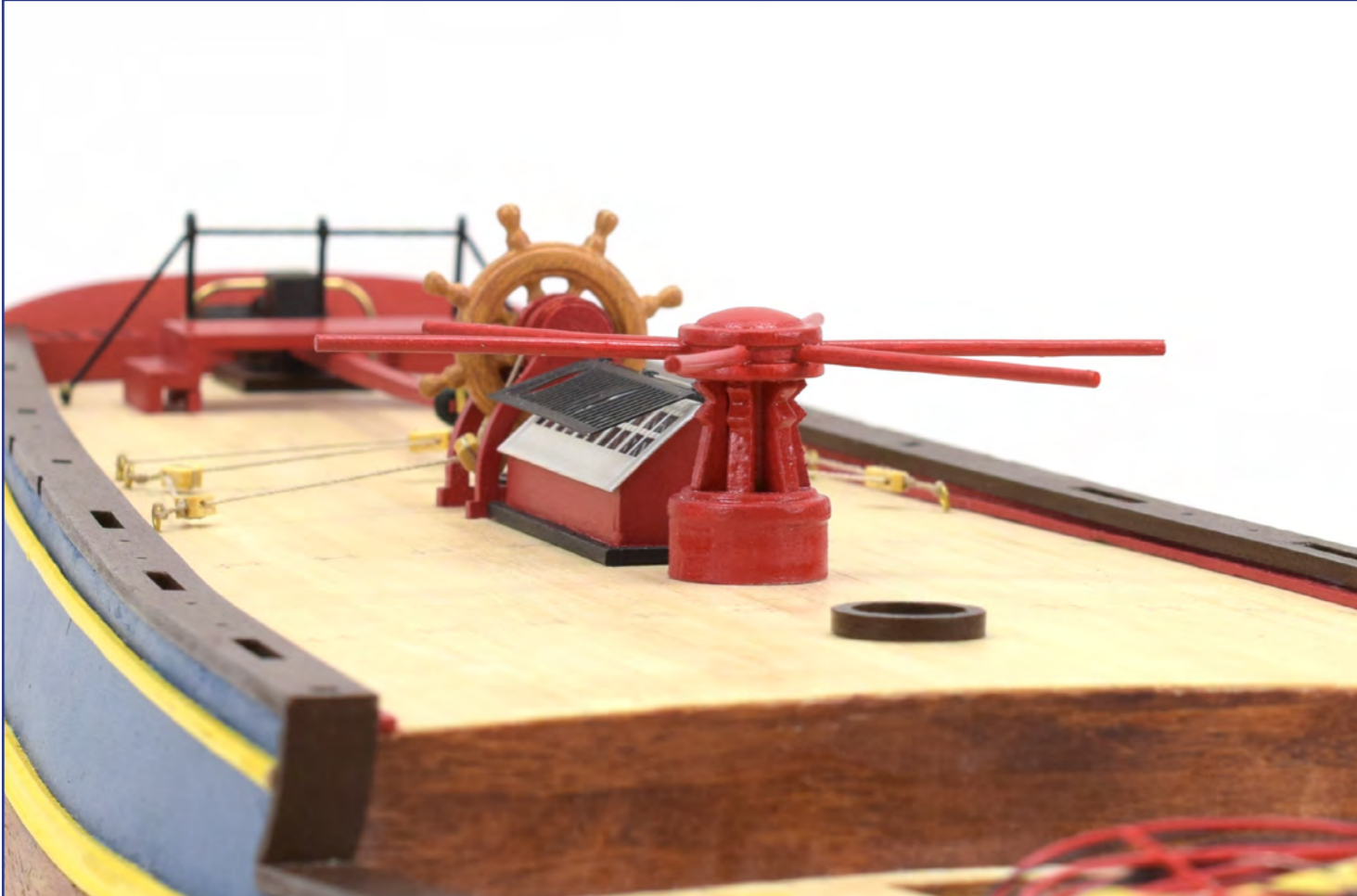
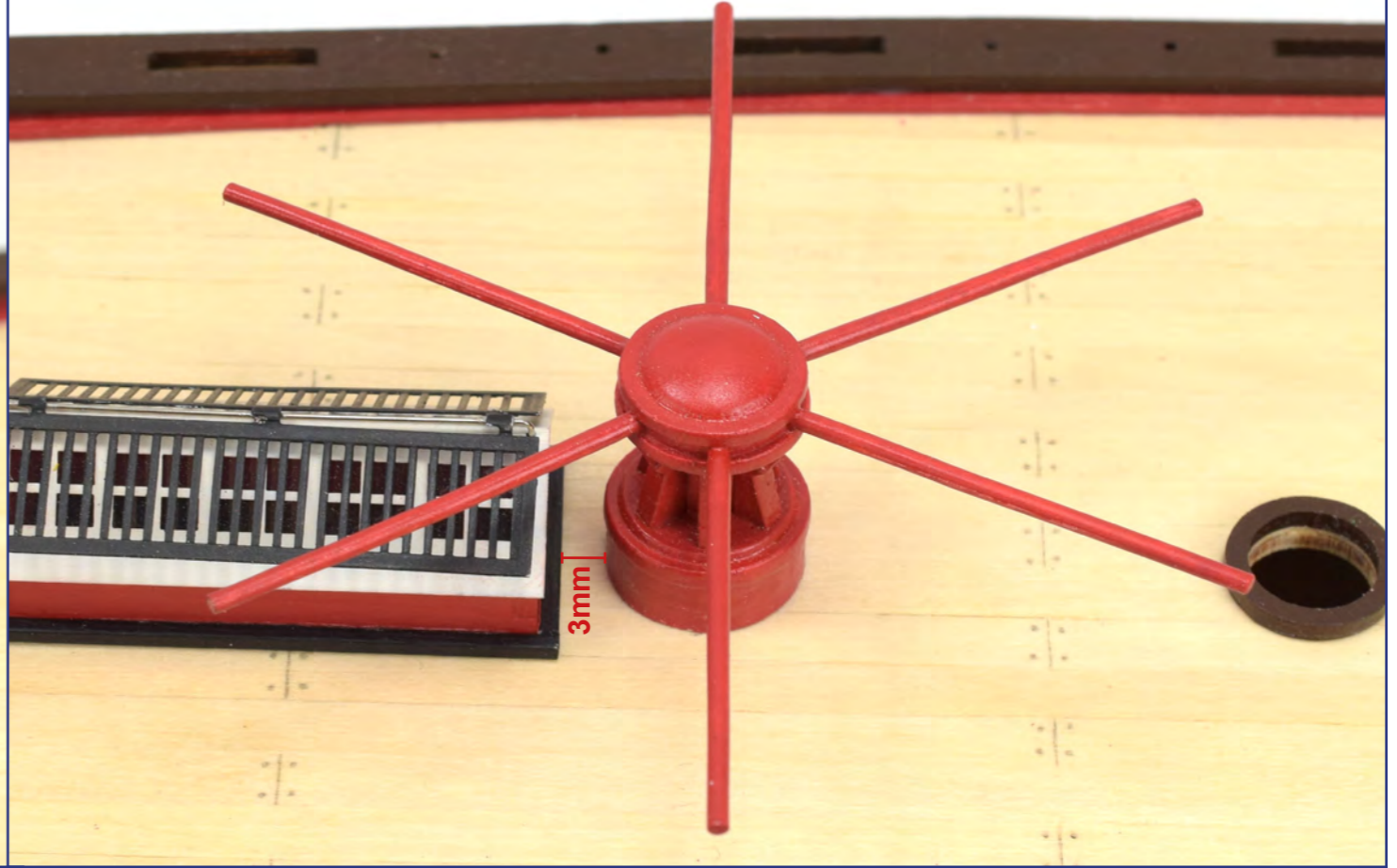
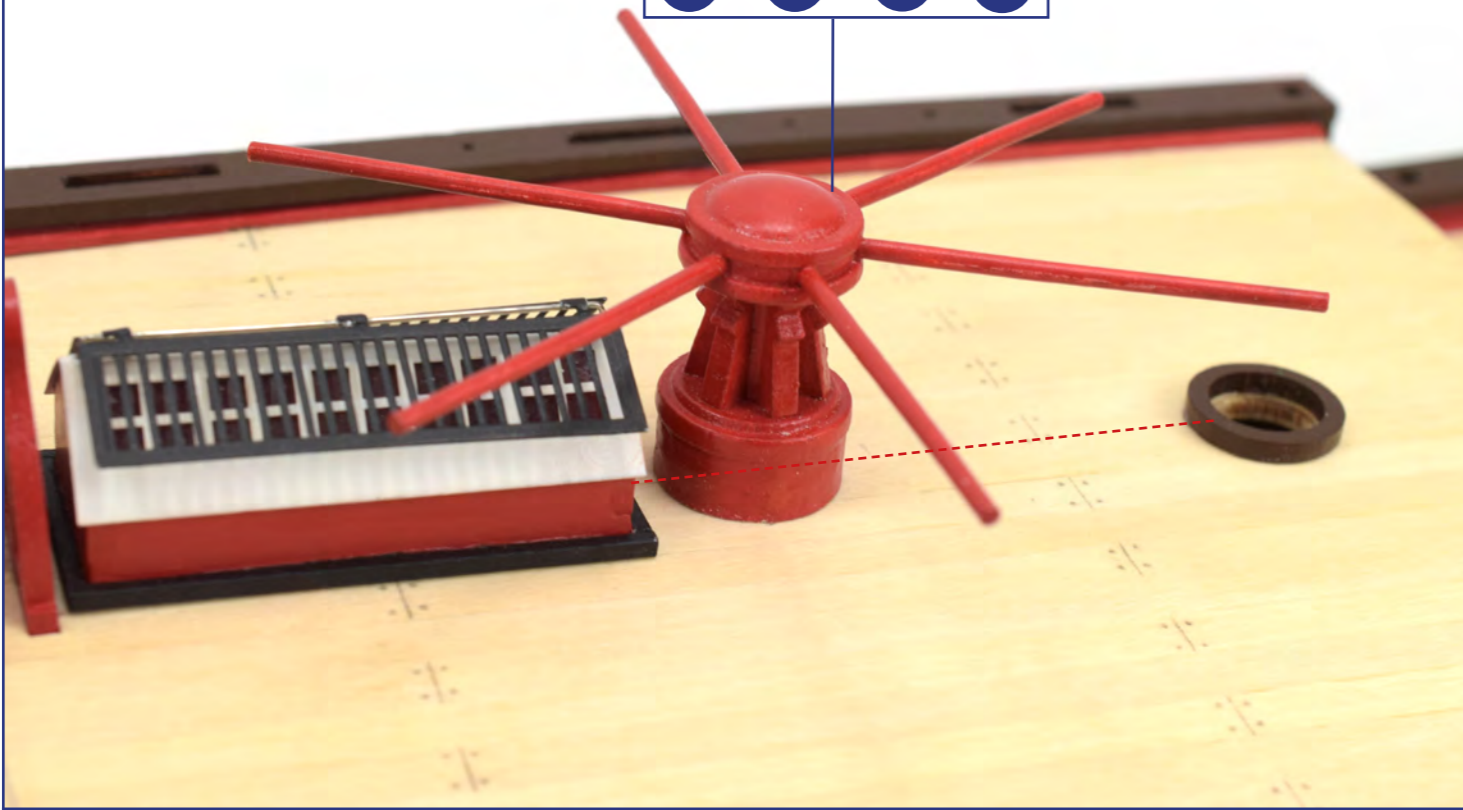

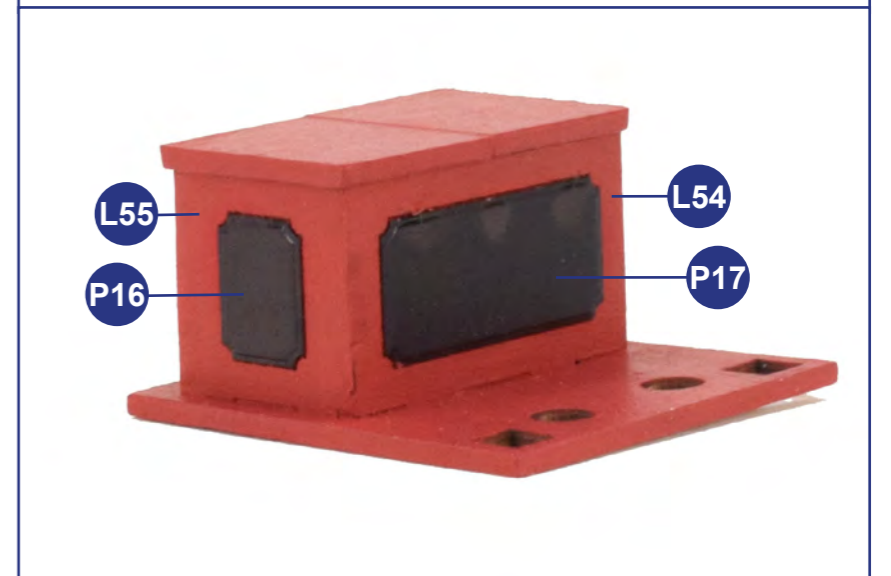
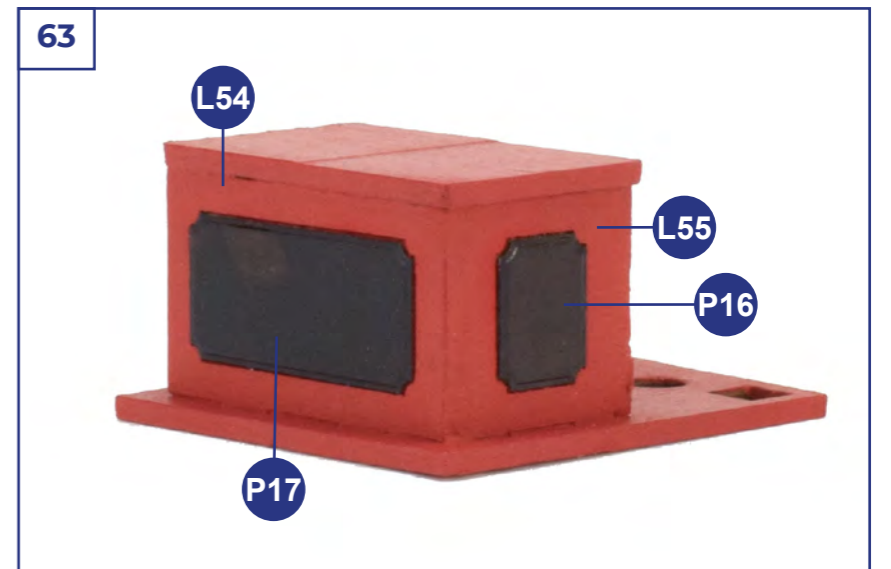
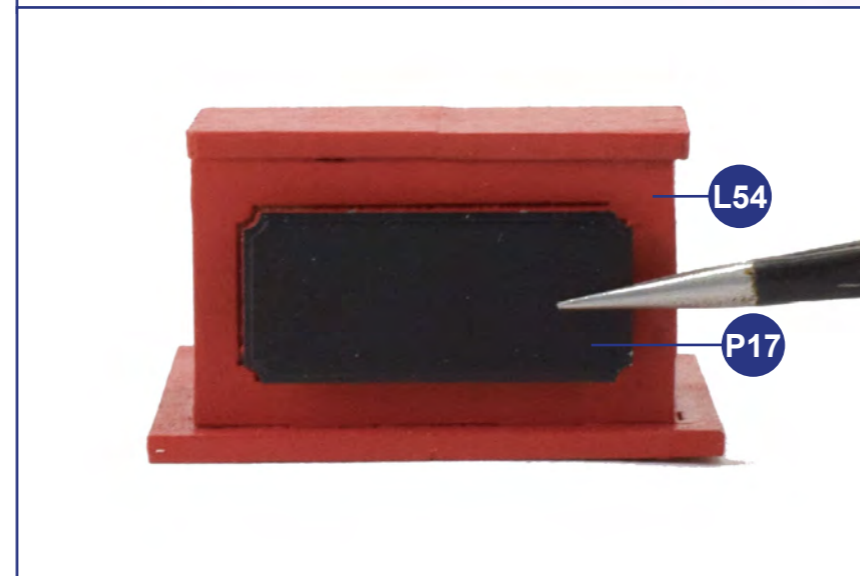
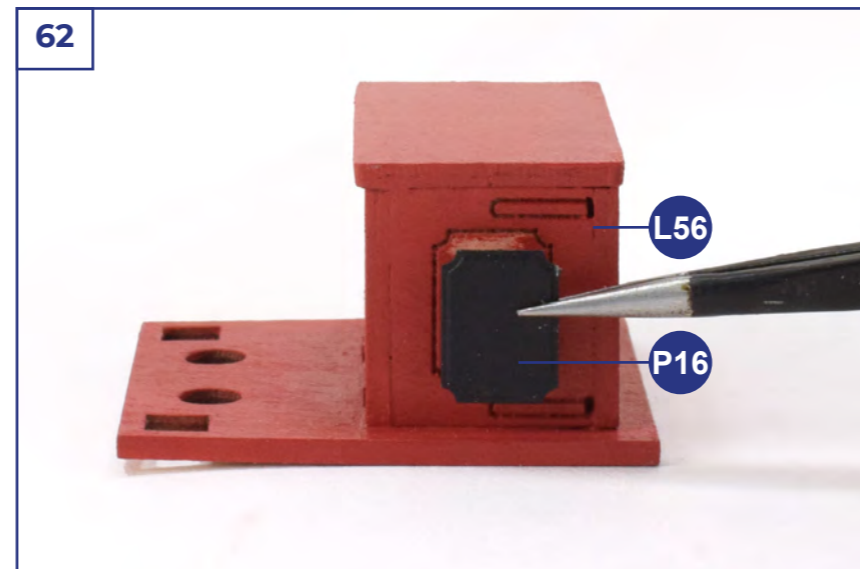
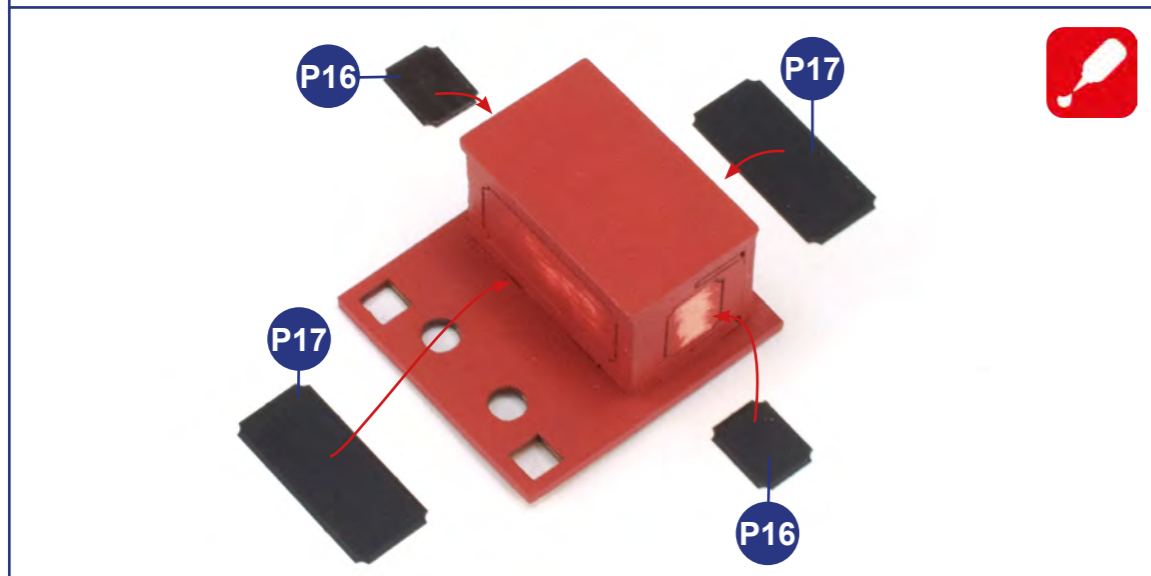
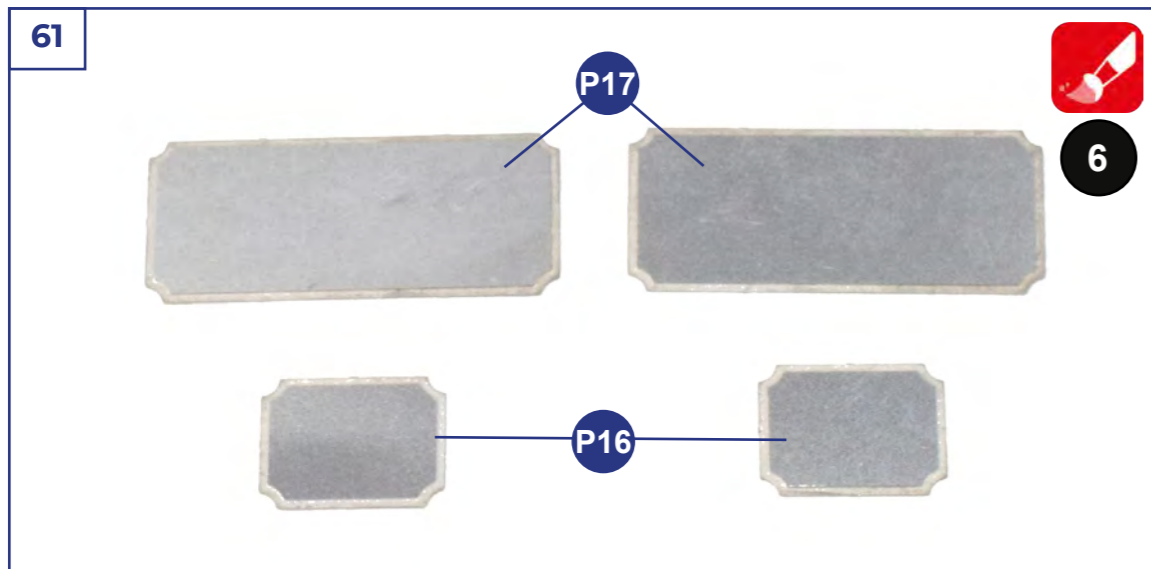
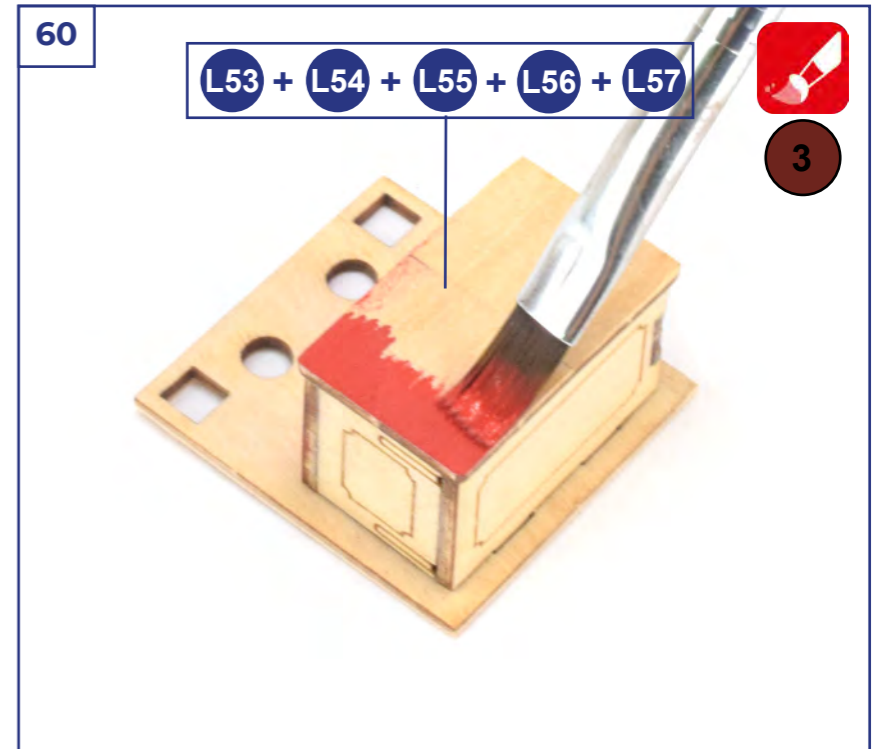
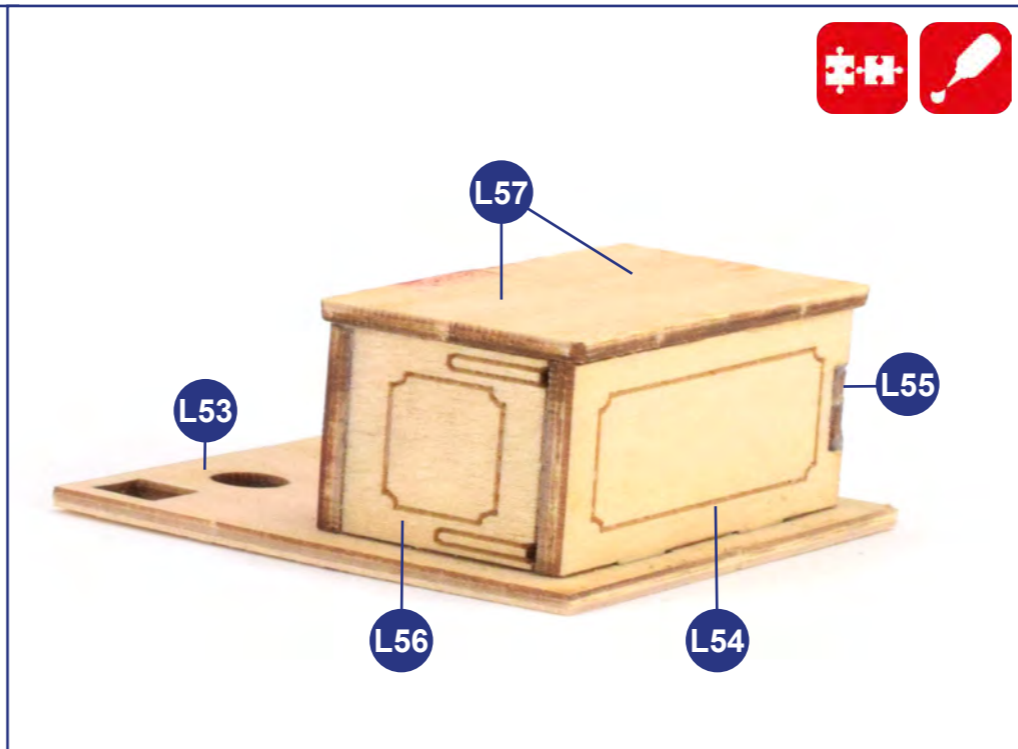
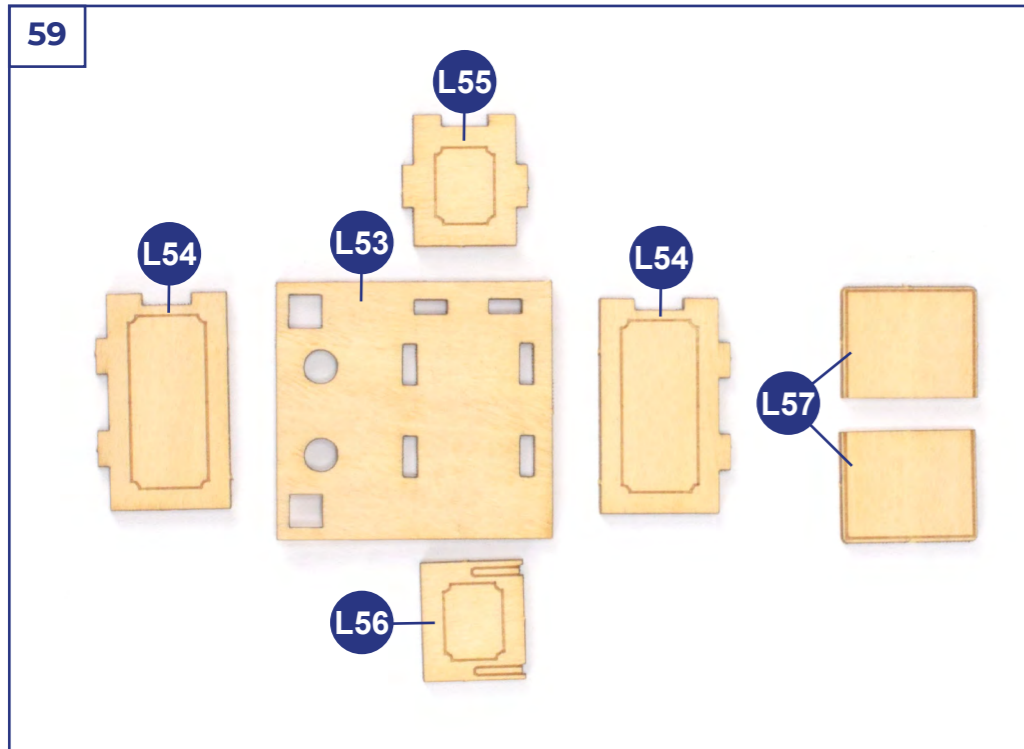

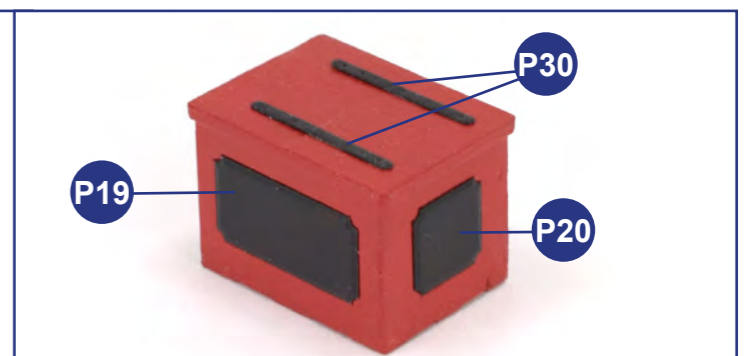
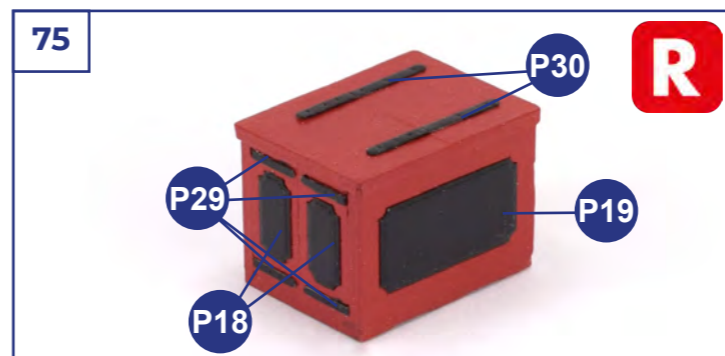
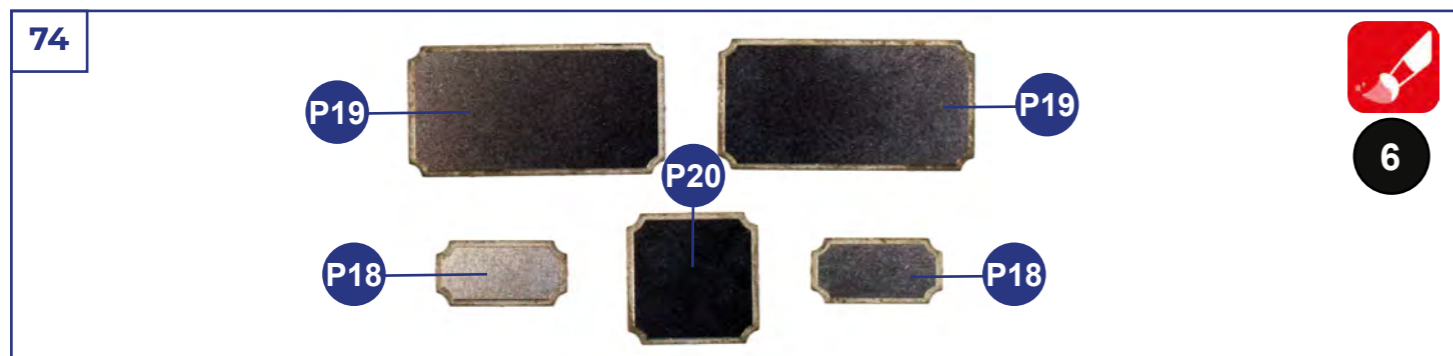
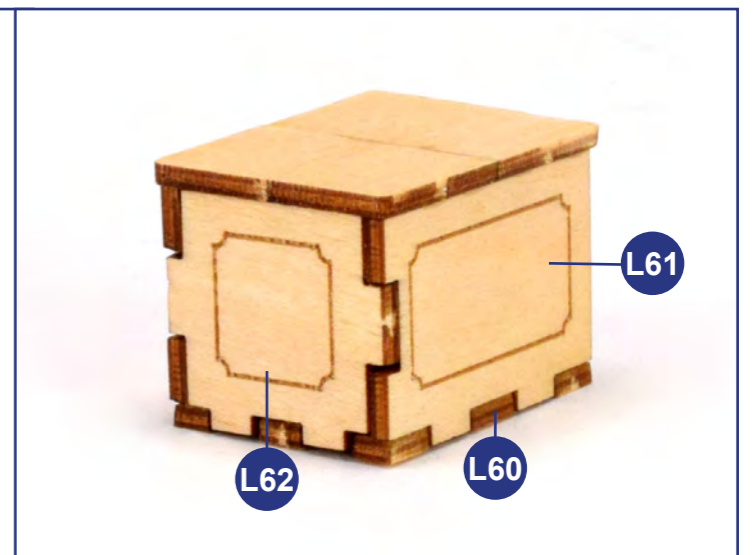
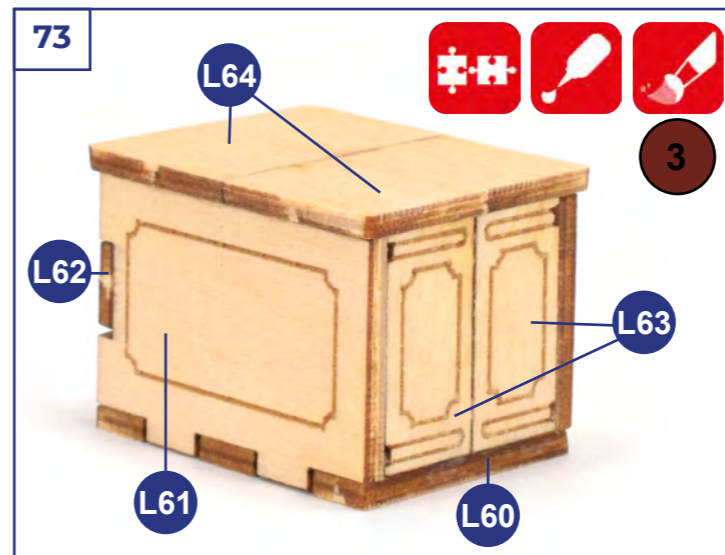
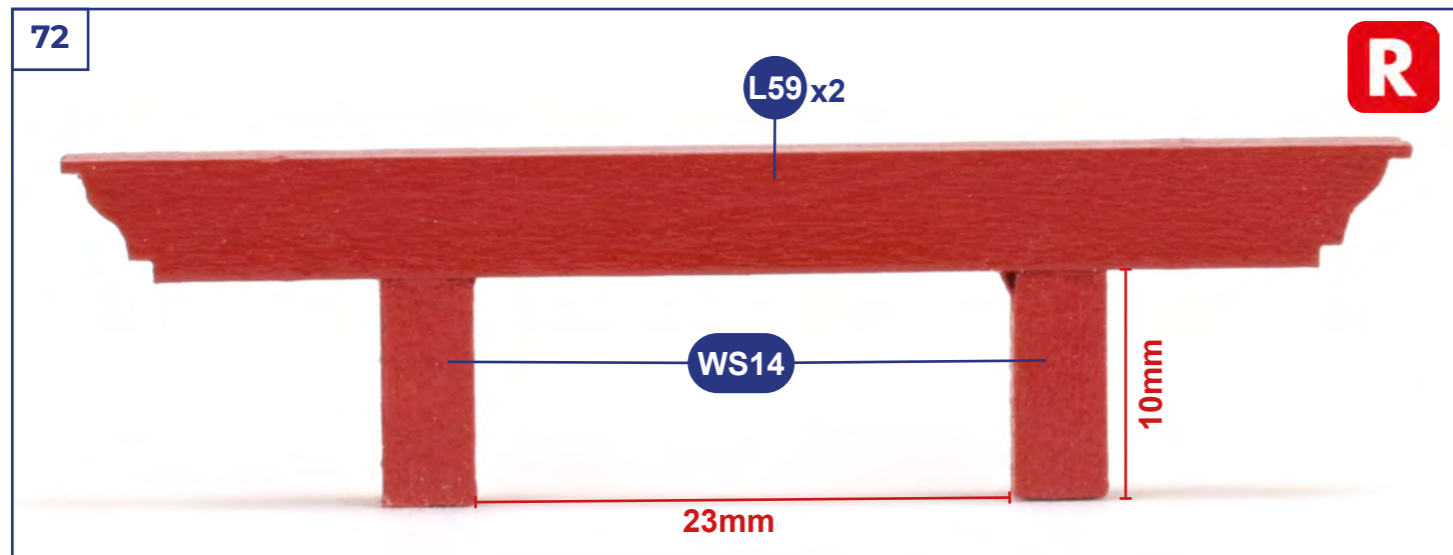
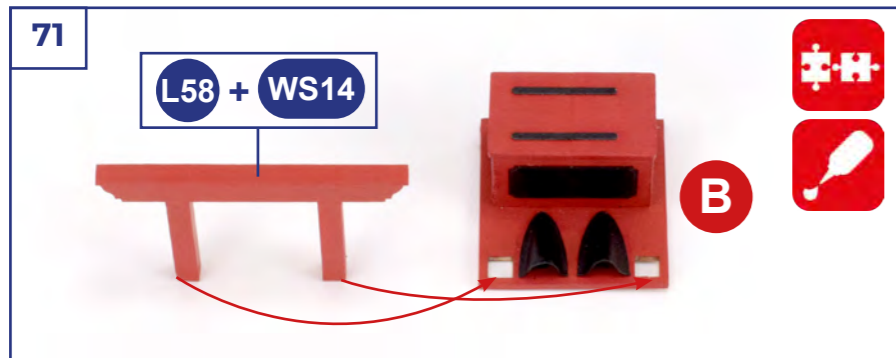
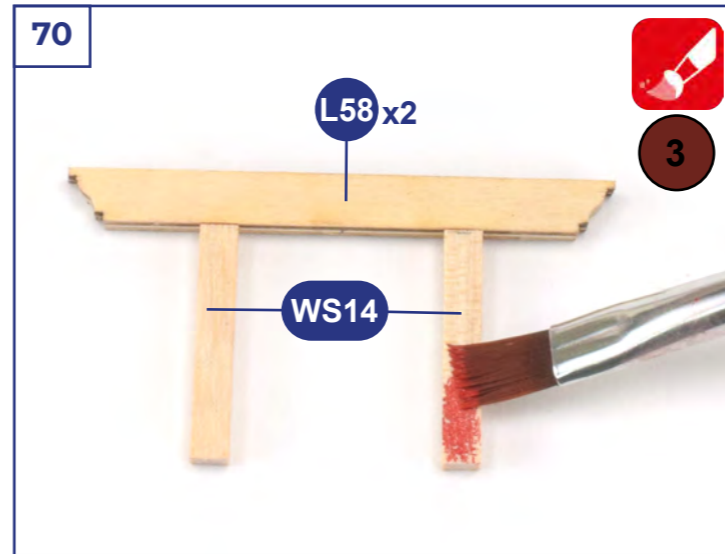
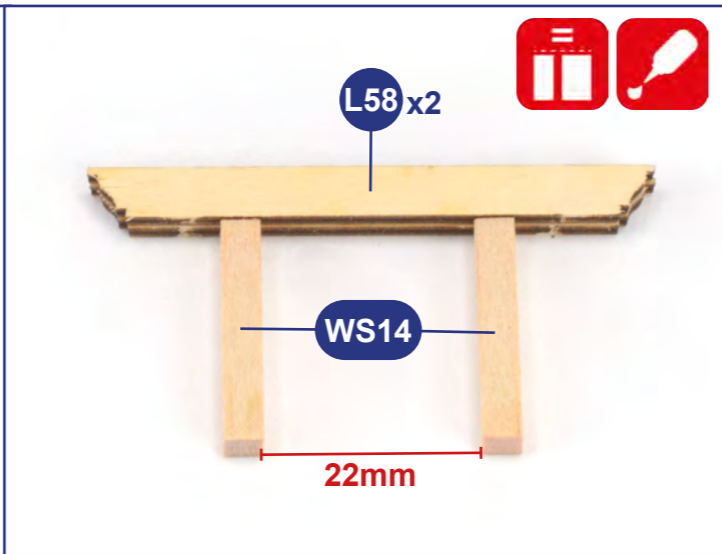
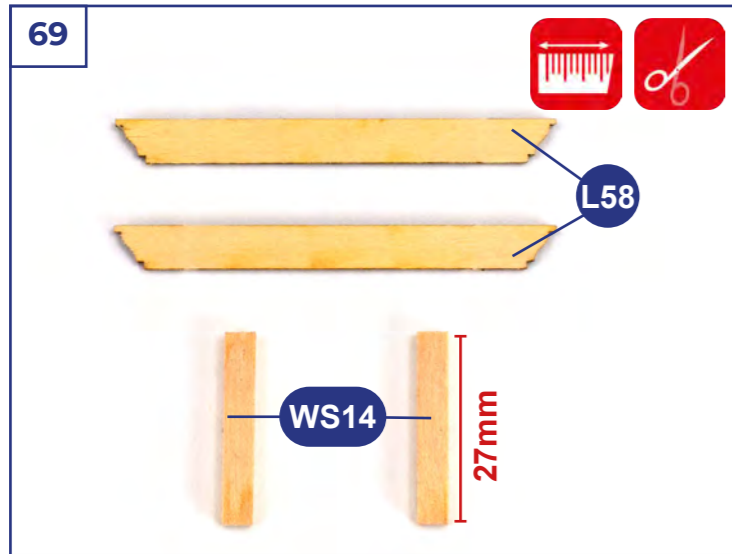

76

WS10 22mm

WS14 16mm

77

WS14

x = 3mm

WS14

WS14

1,5mm

78

WS10

WS14

WS10

WS14

3mm

3mm

79

WS14

Ø1mm

WS14

80

WS10

WS14

F3 6mm

F3 6mm

WS14

WS14

F3

F3

81

WS10

WS14

WS14

F3

F3

3

82

WS10 33mm

WS14 16mm

F3 6mm

F3 6mm

R x2

83

3

84

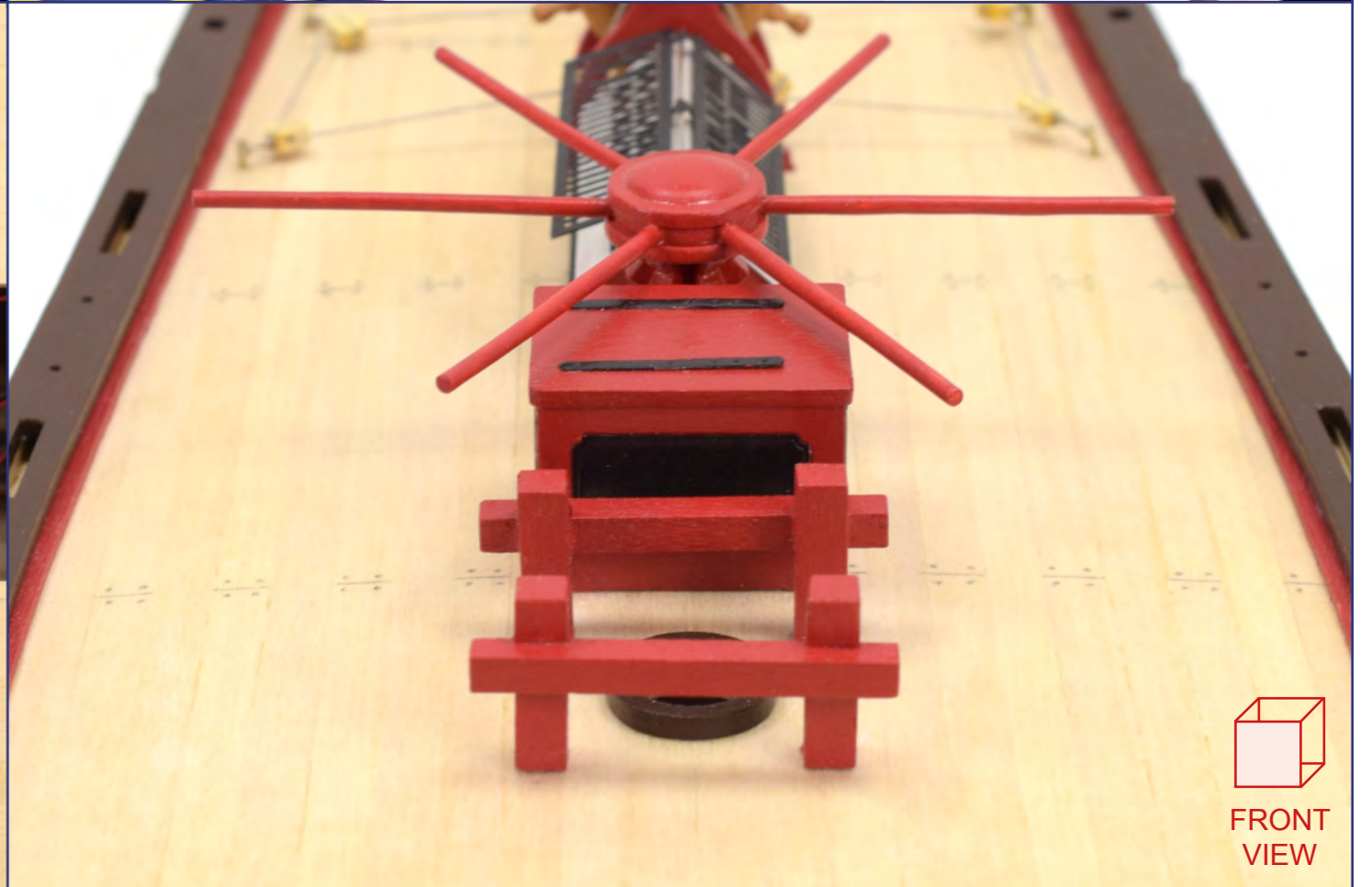
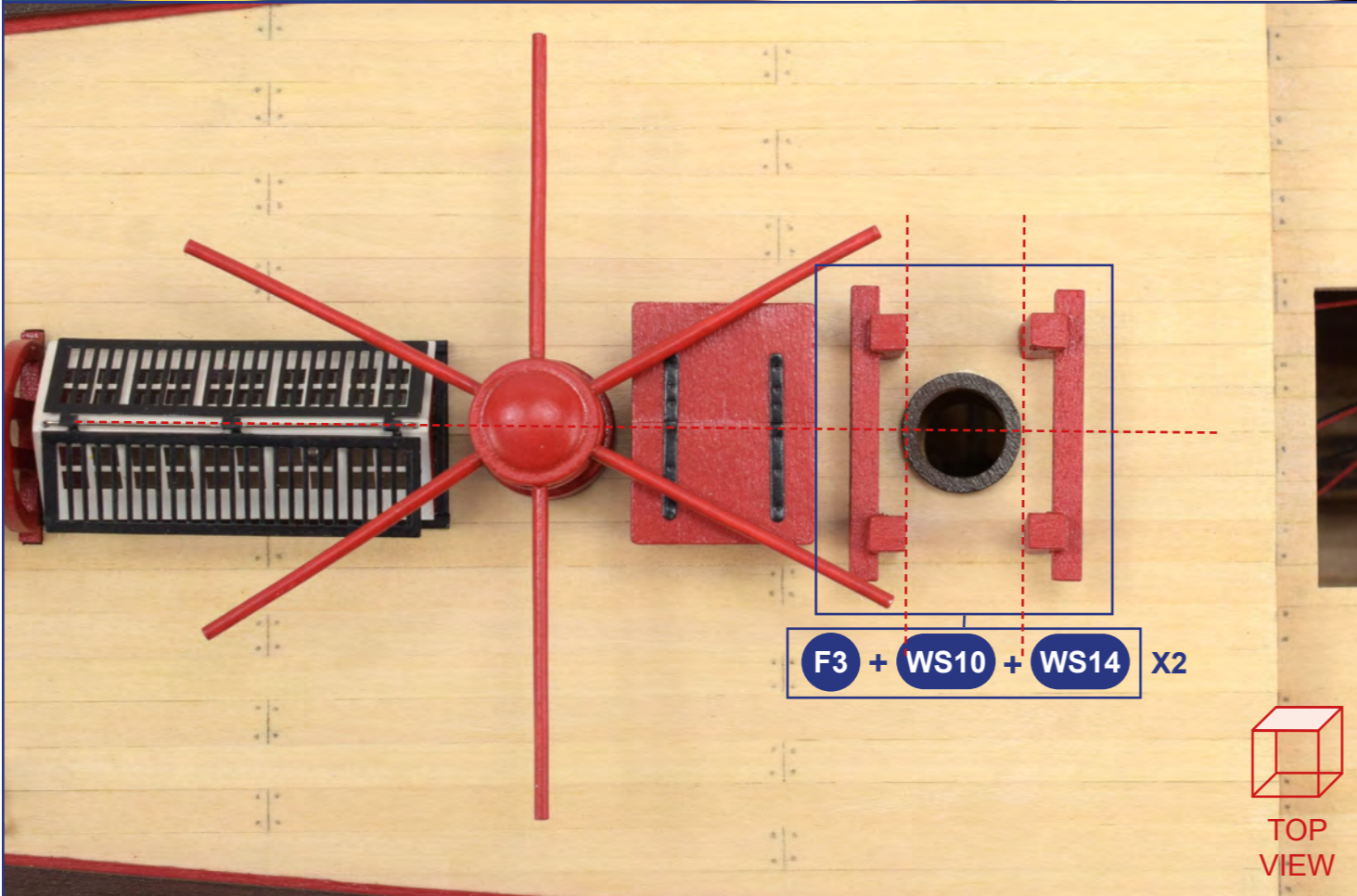
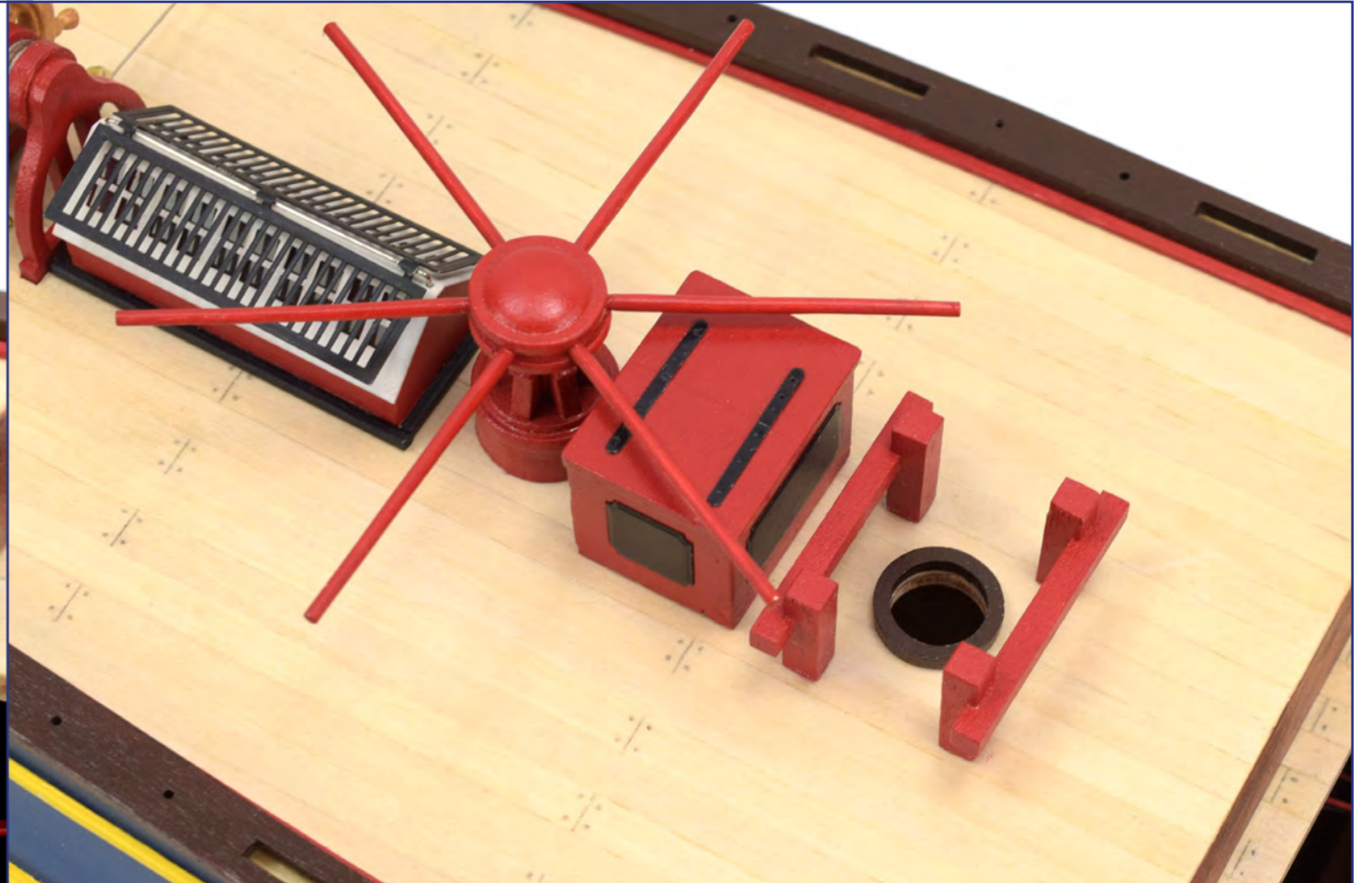
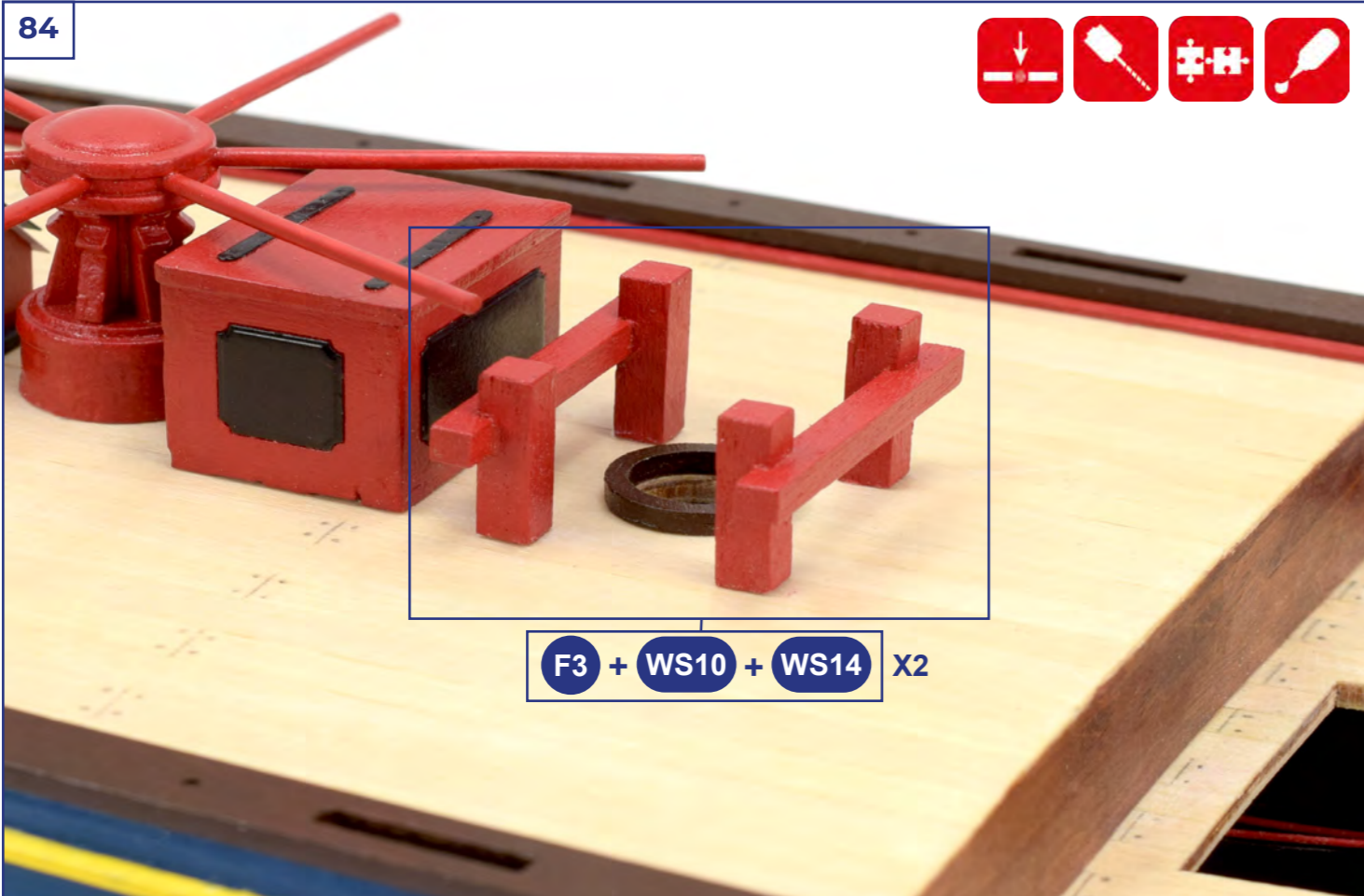

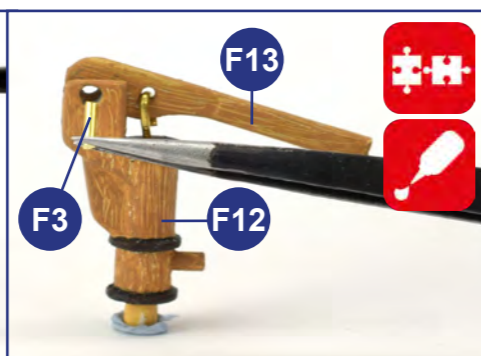
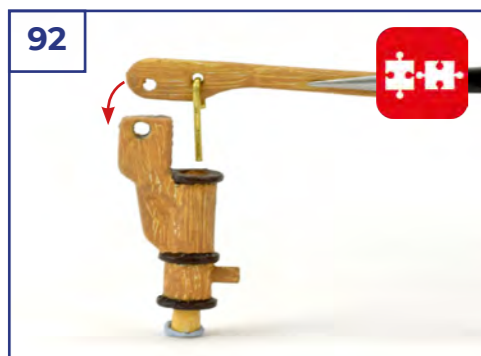
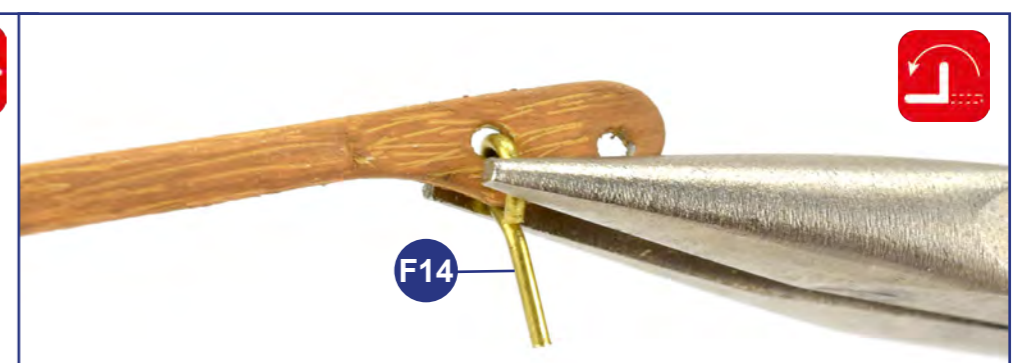
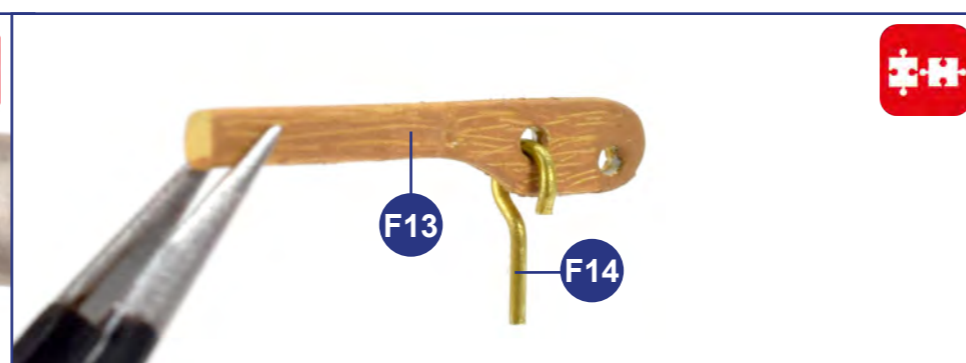
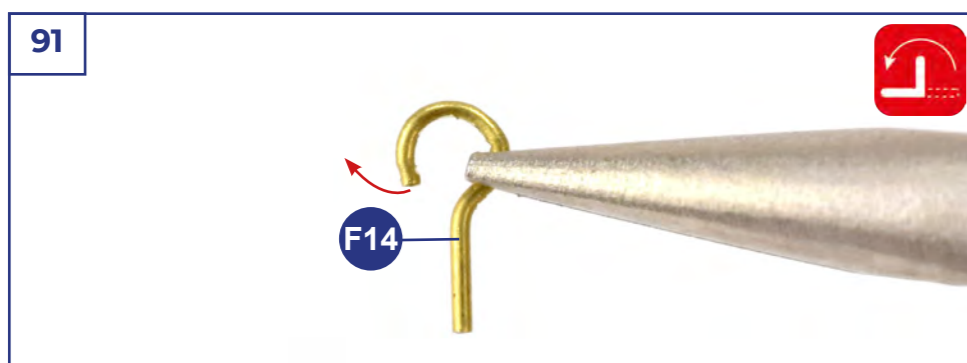
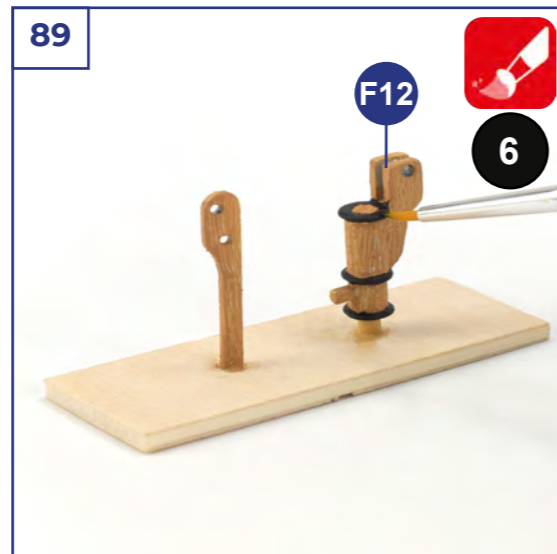
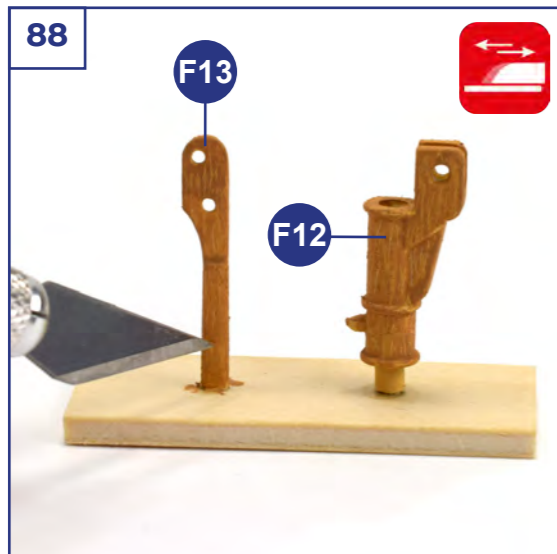
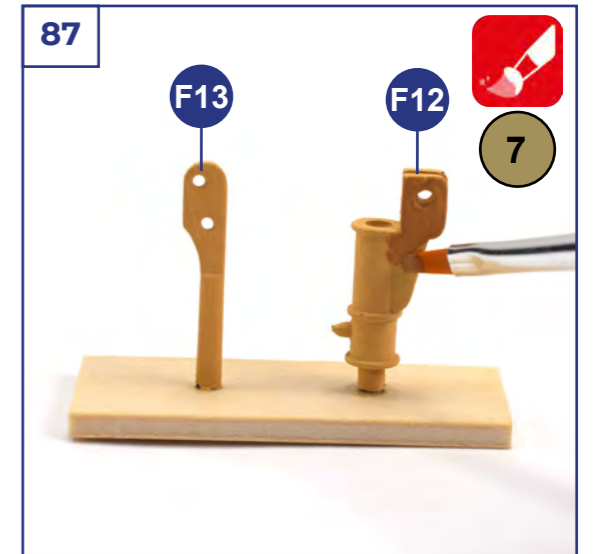
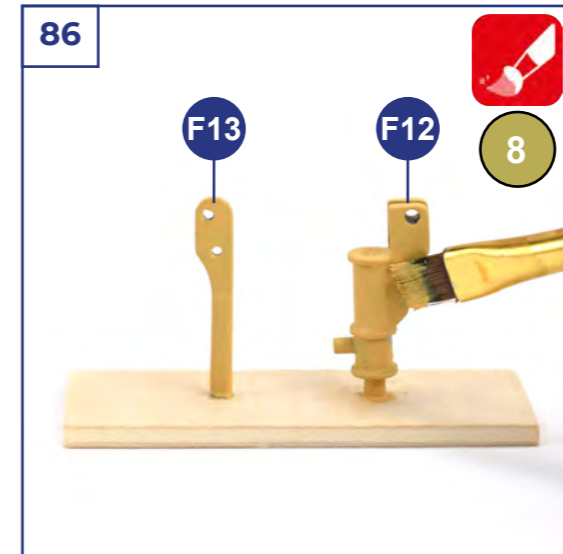
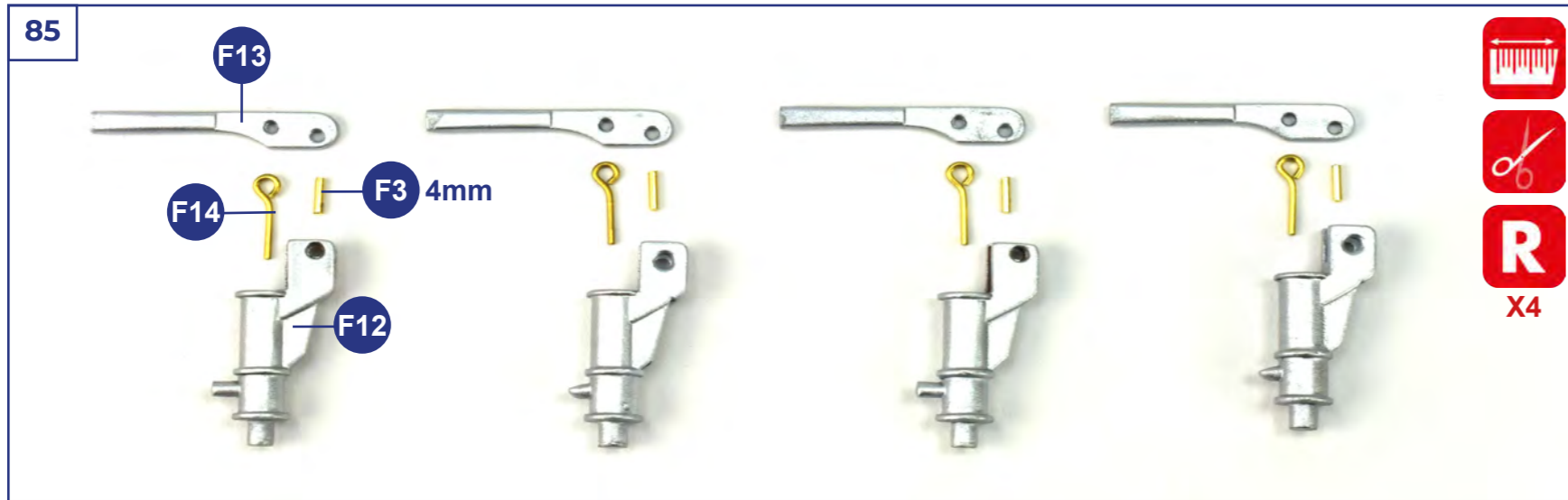

94

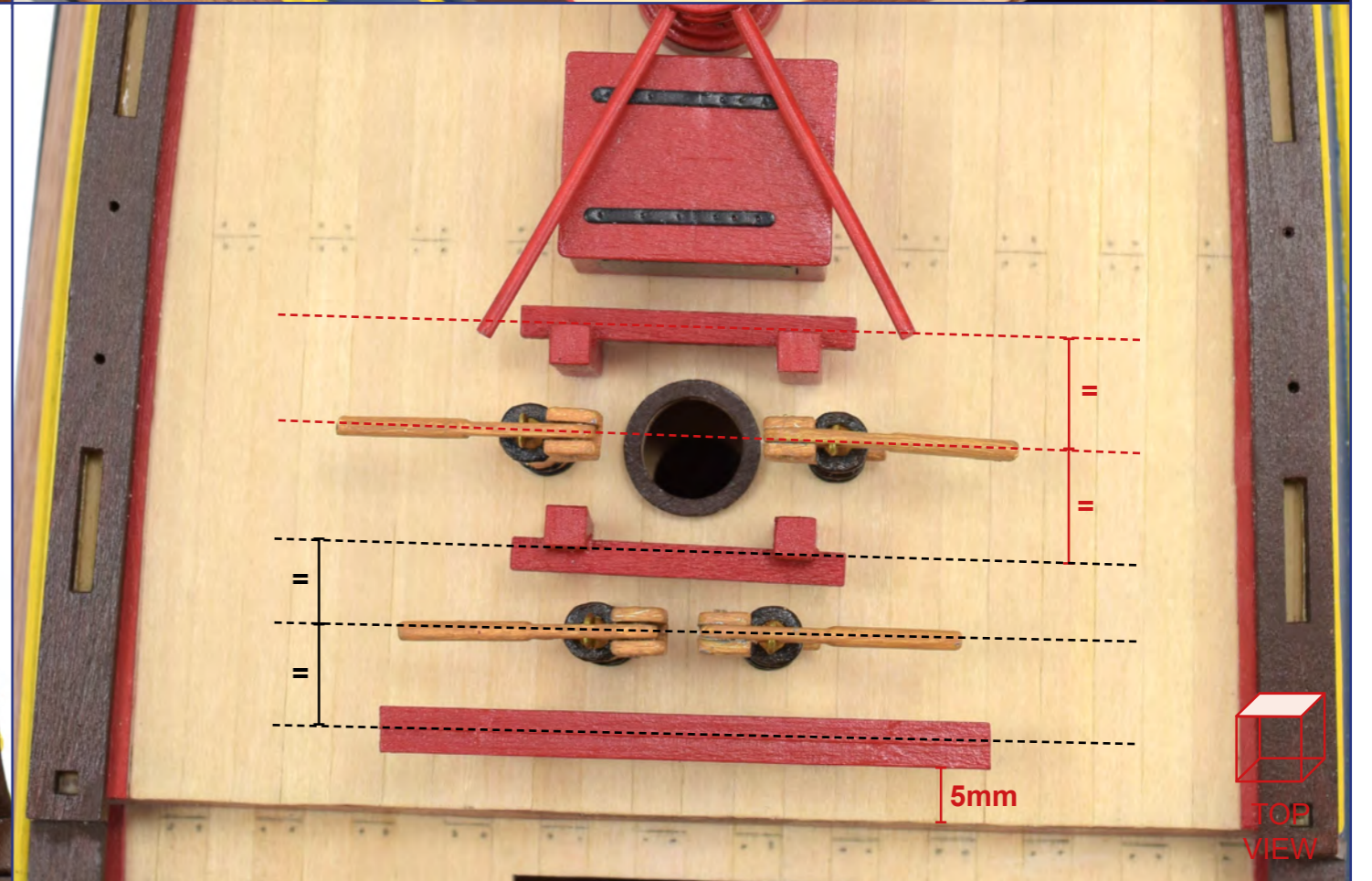
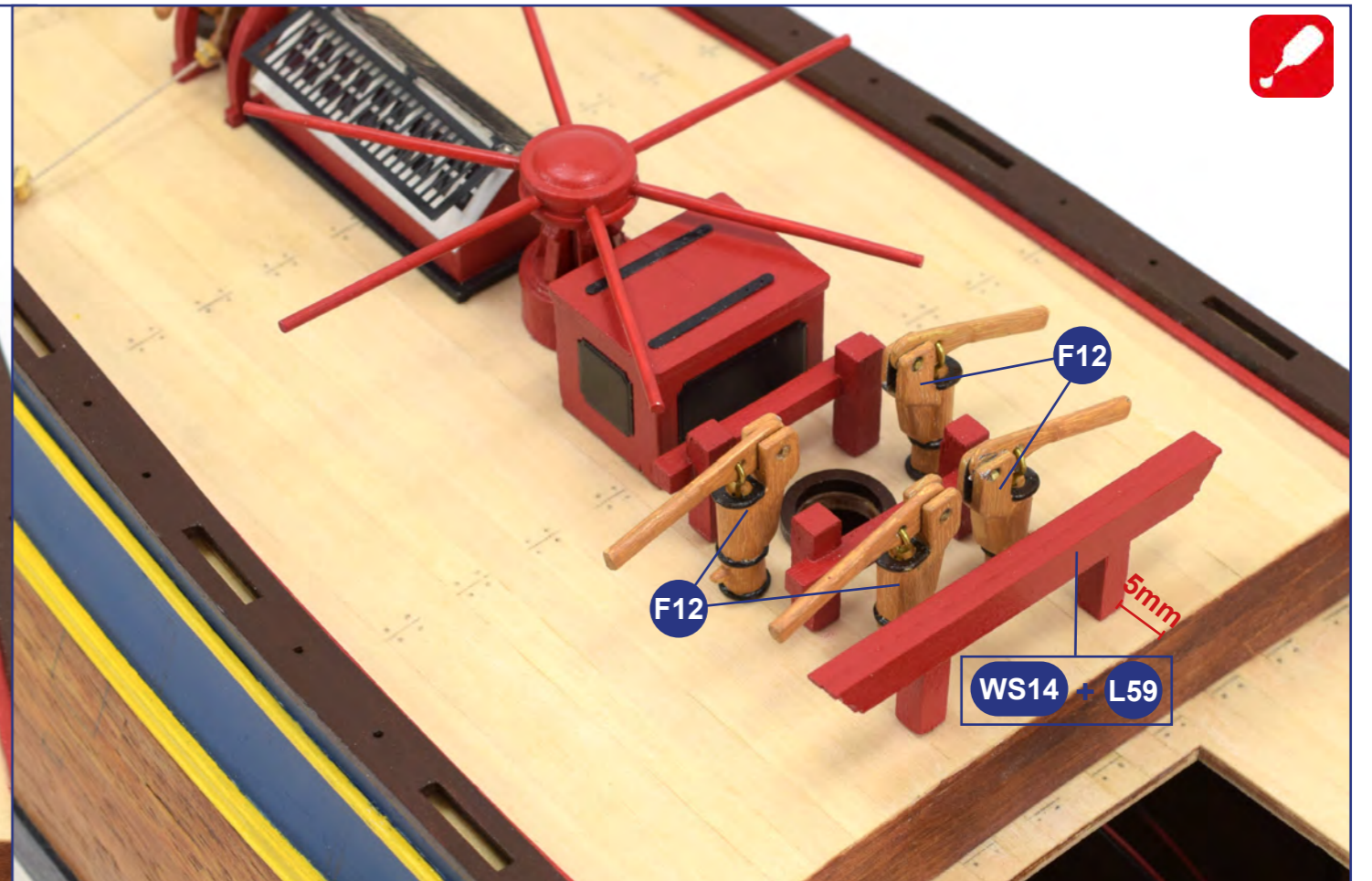
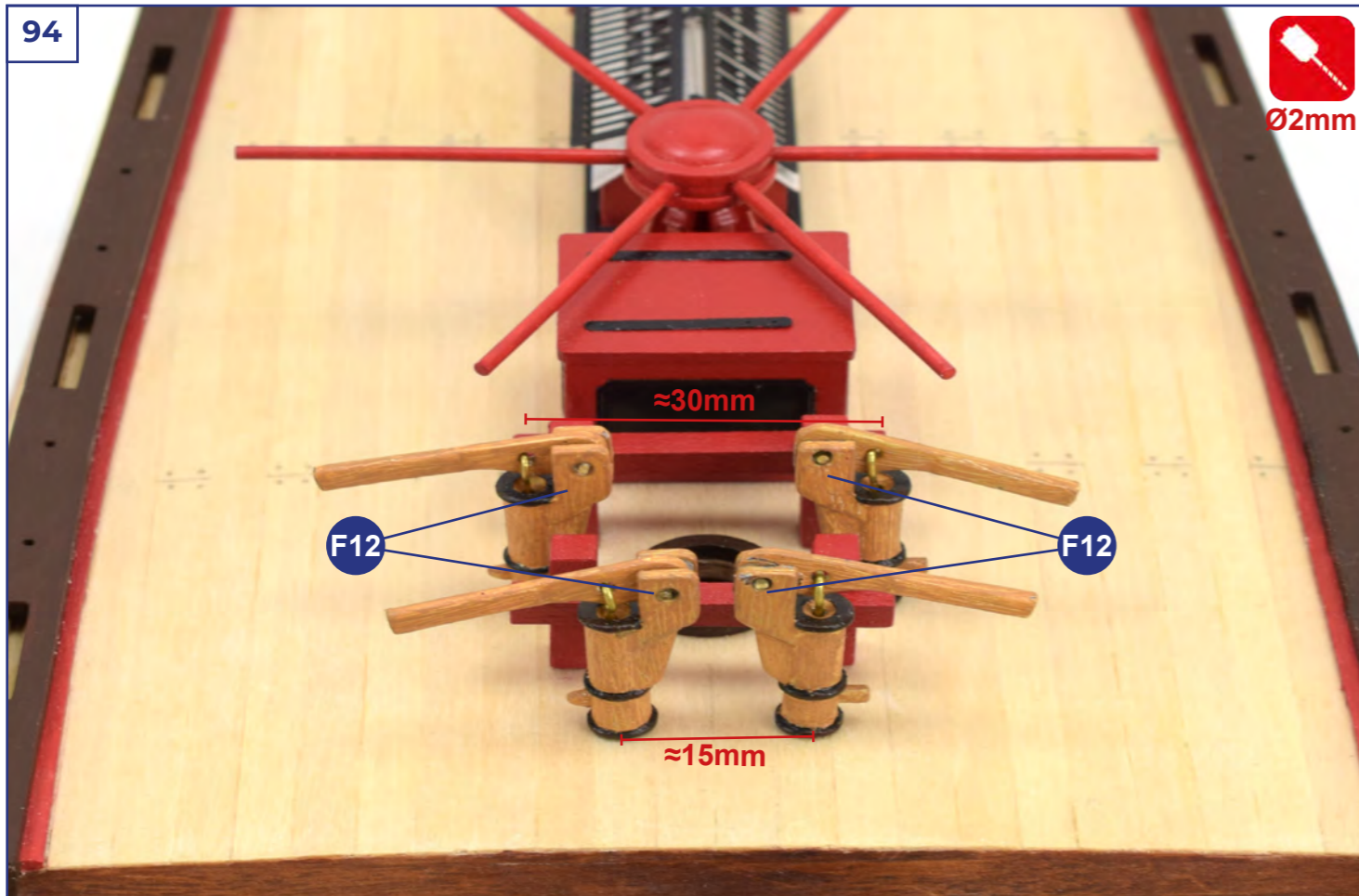

95

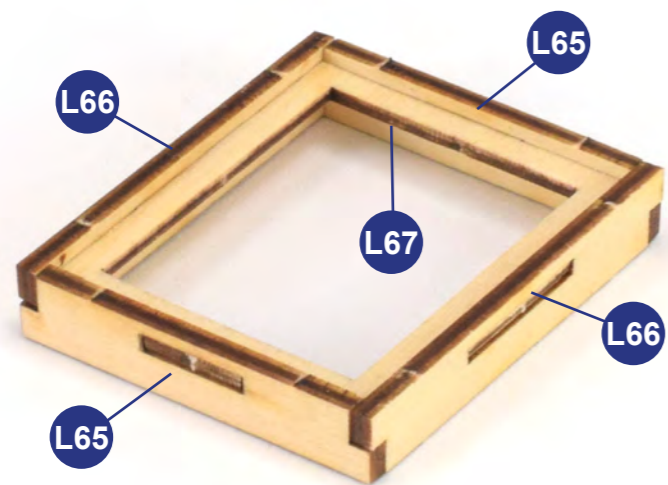
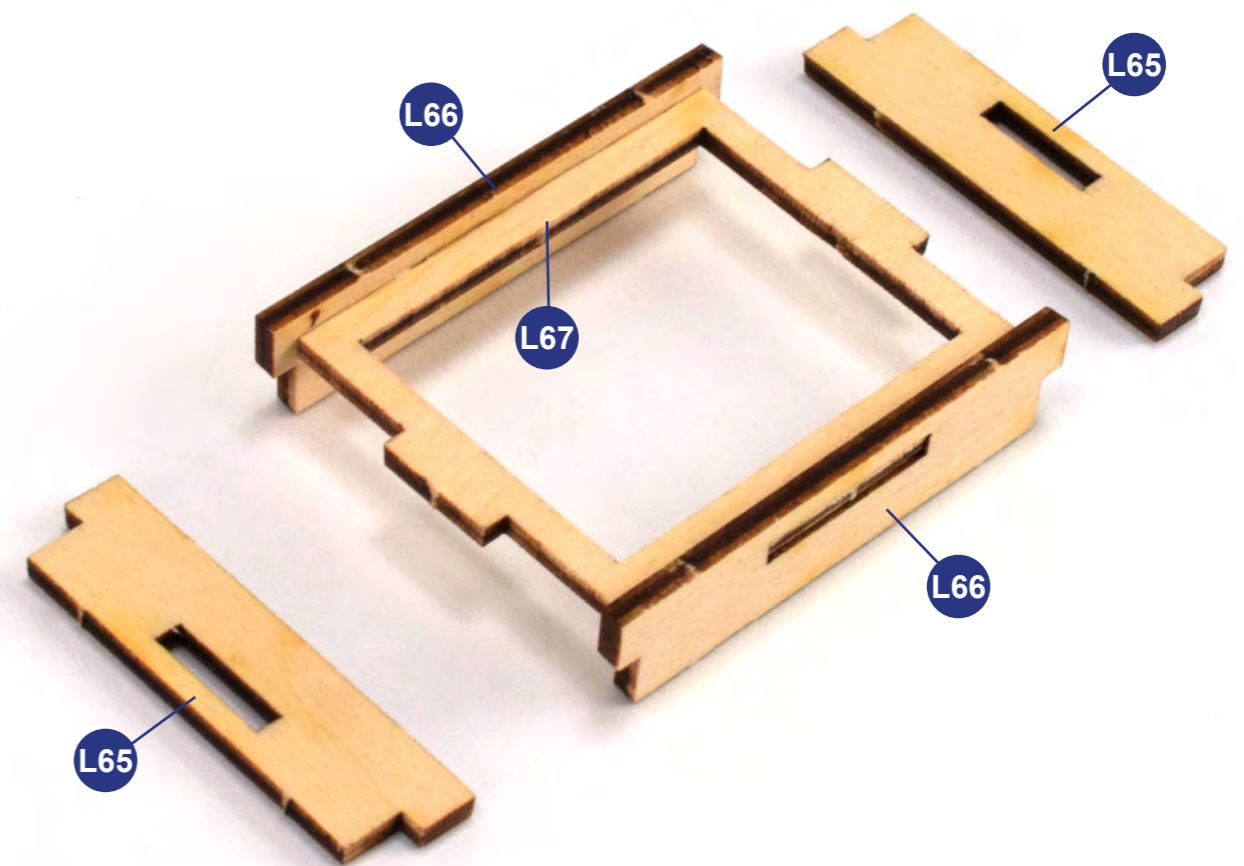
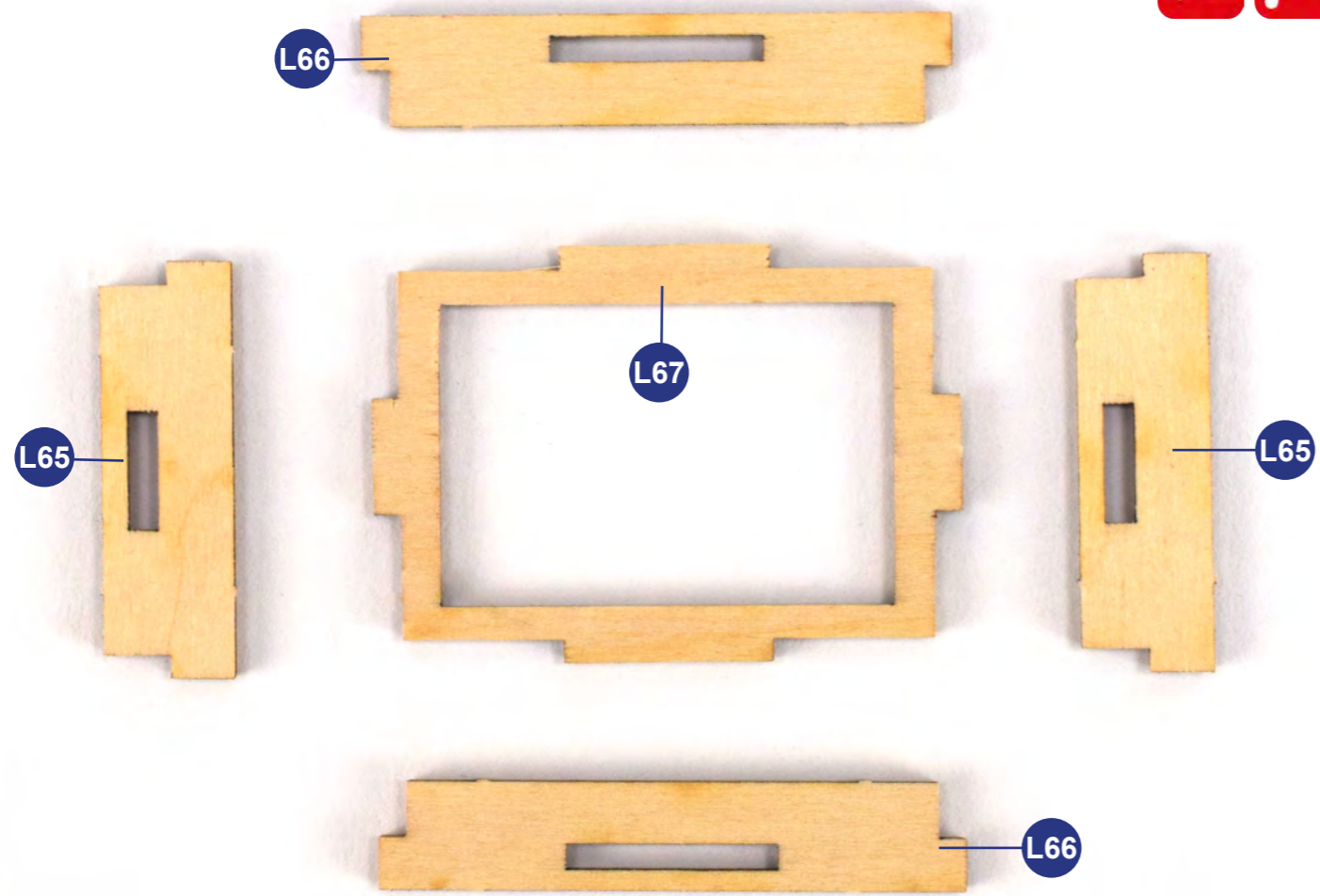

TOP VIEW



96

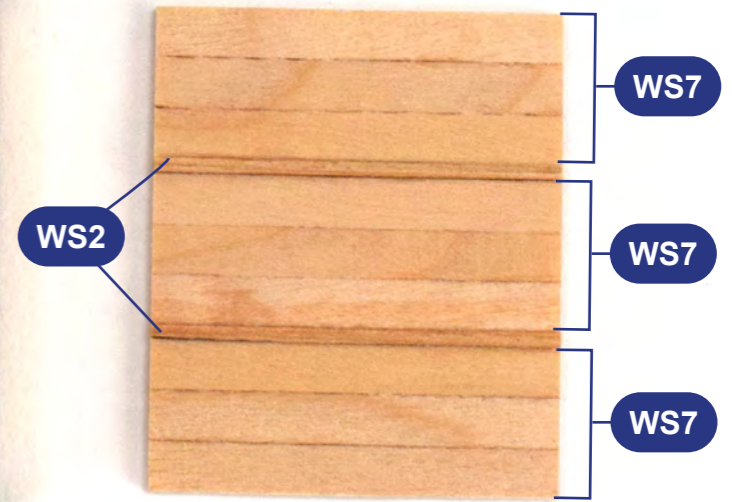
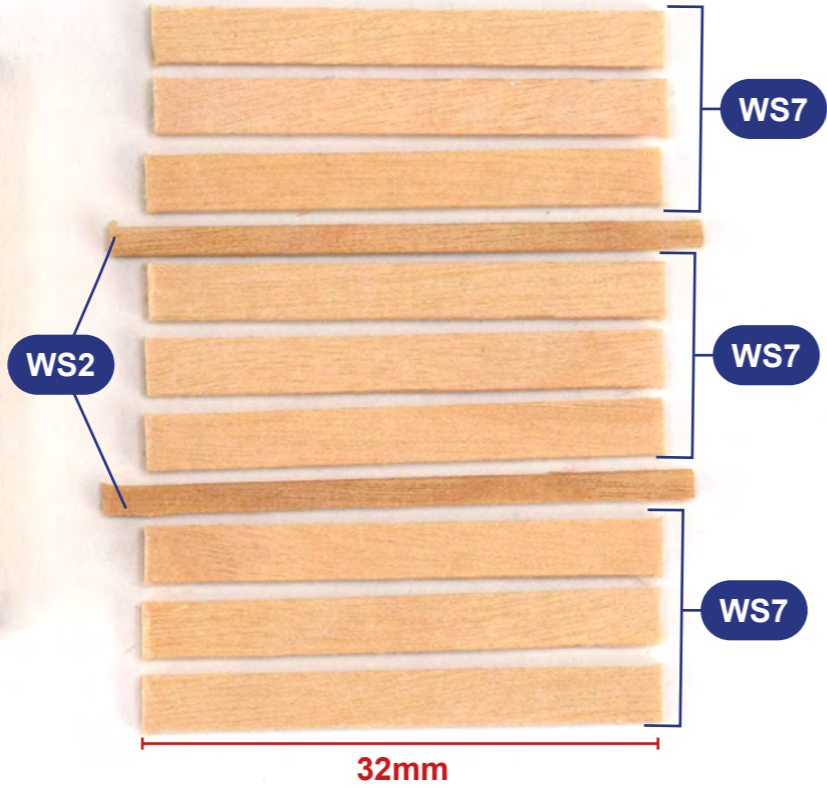

L65 + L66 + L67

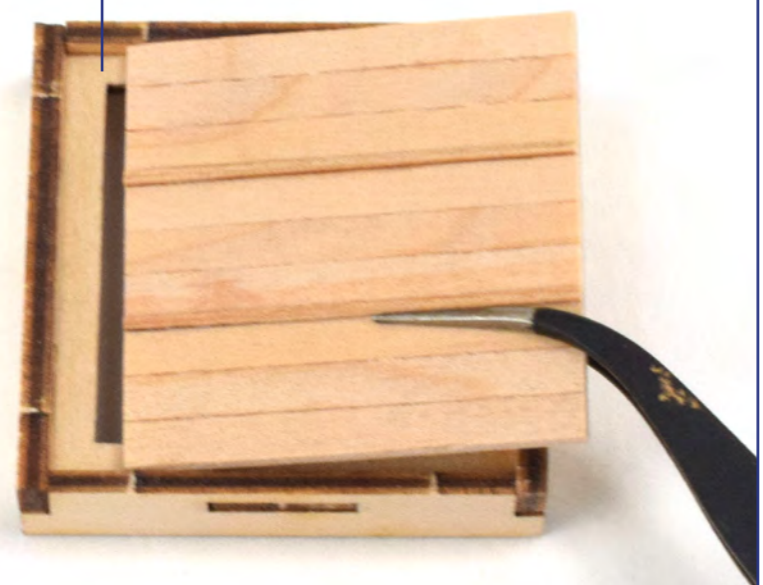

97

L65 + L66 + L67



WS2 + WS7



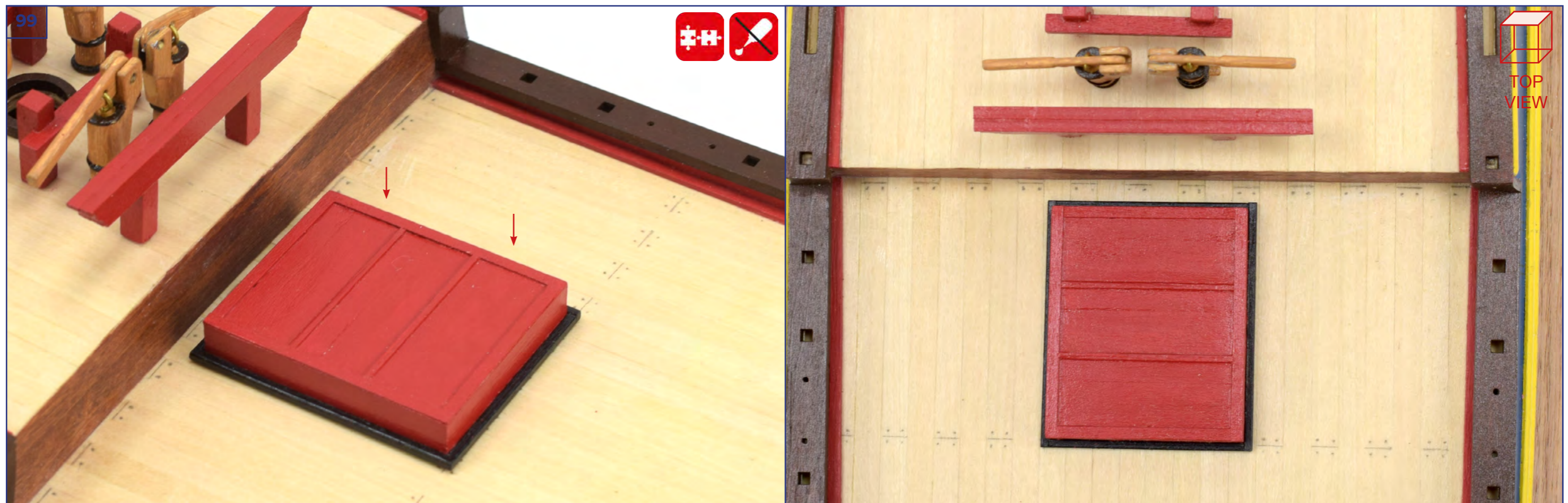
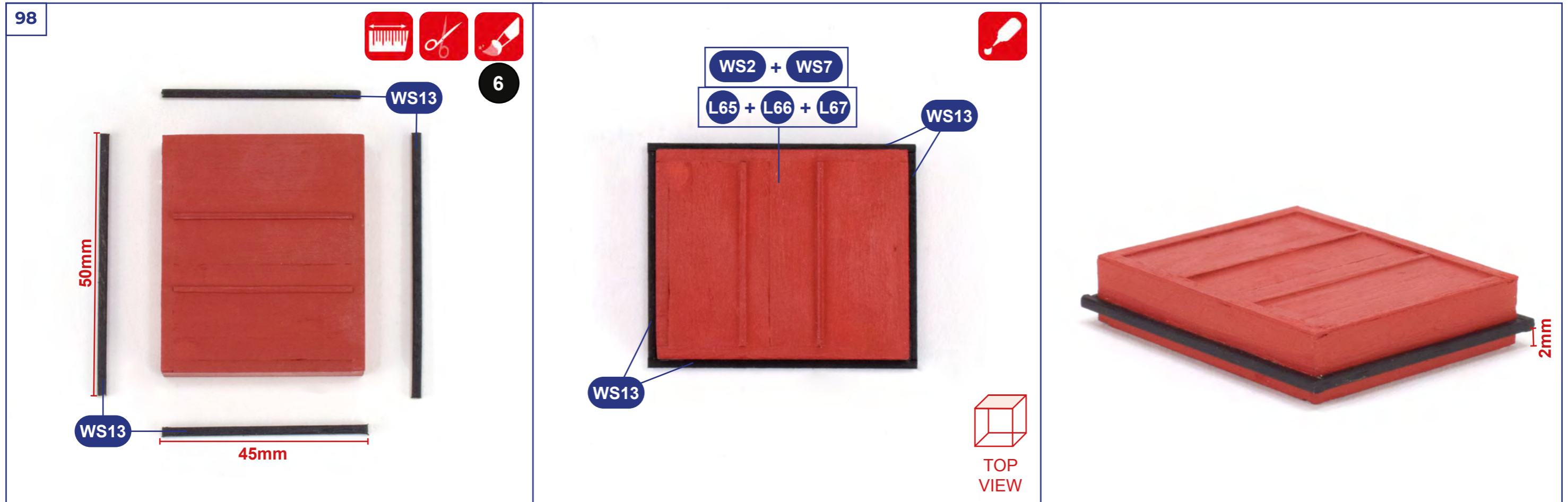

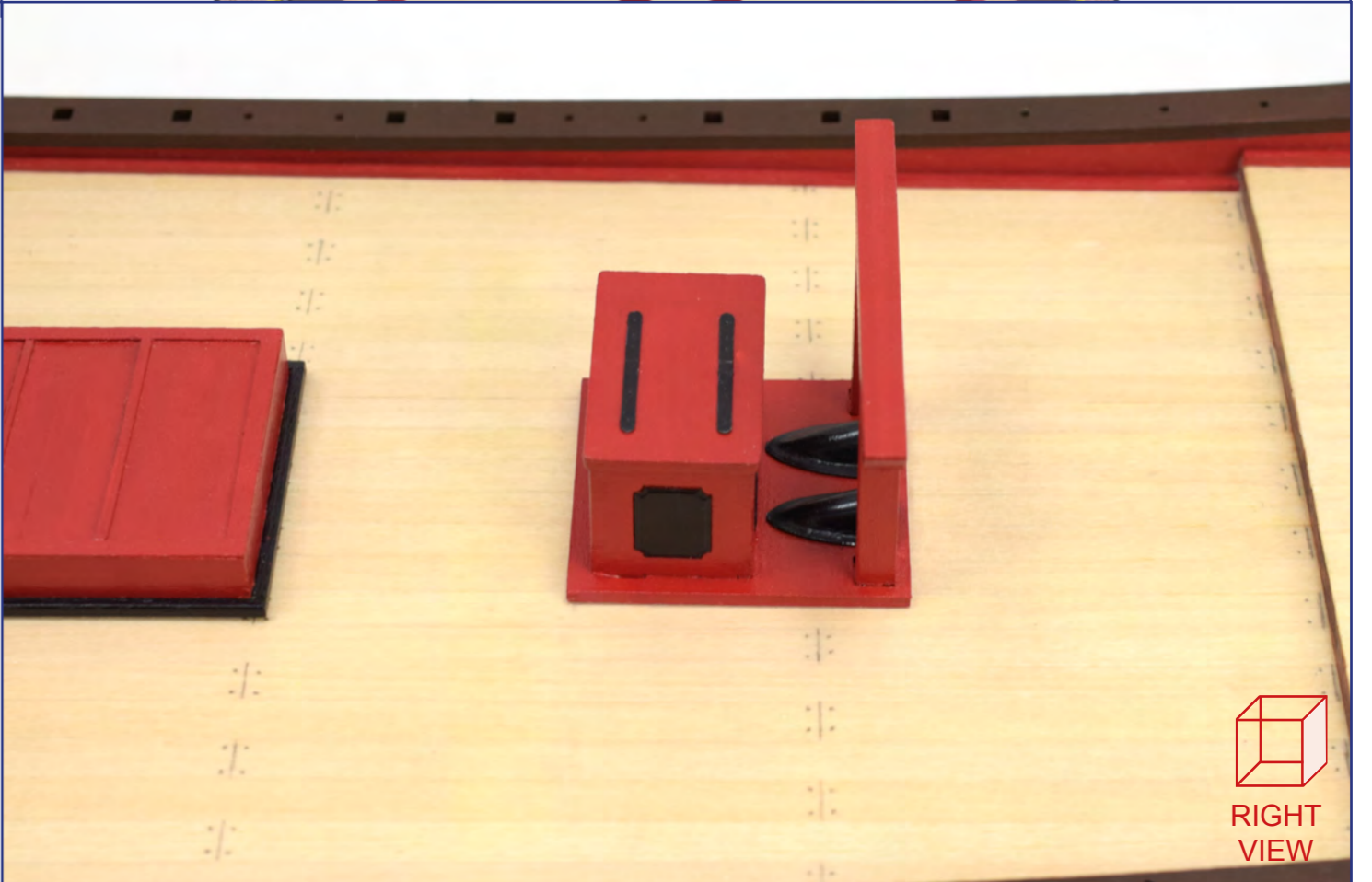
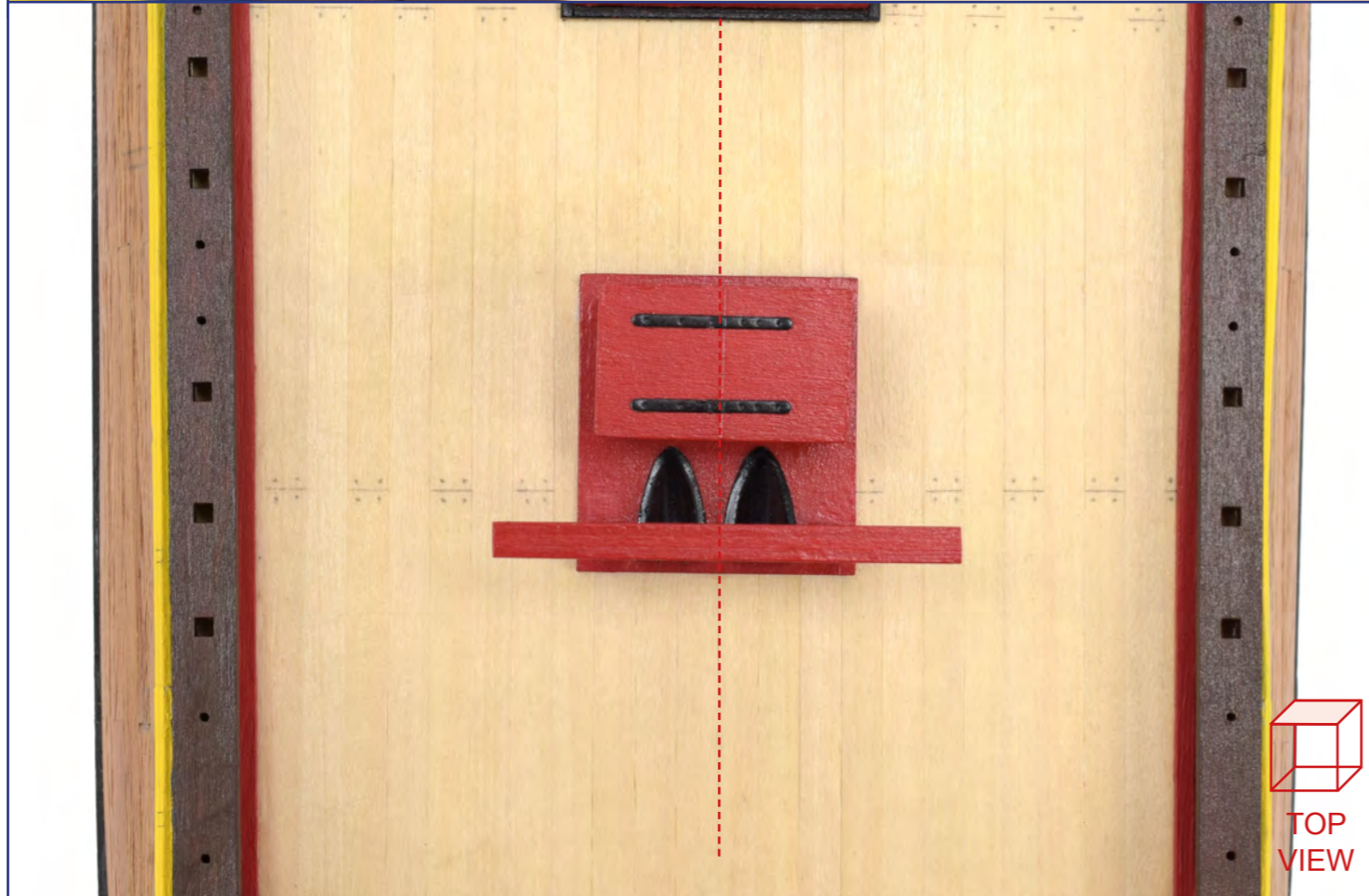
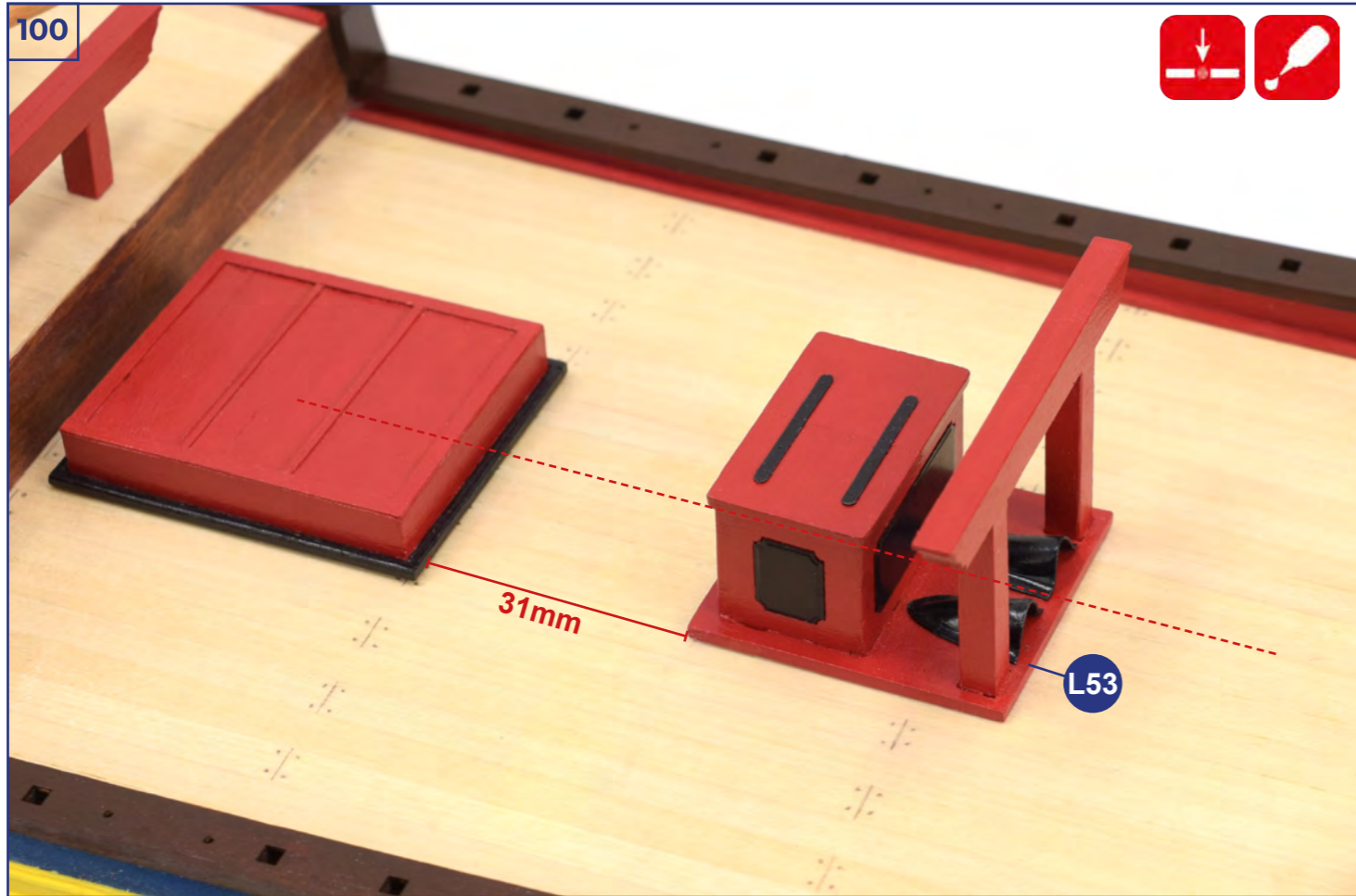

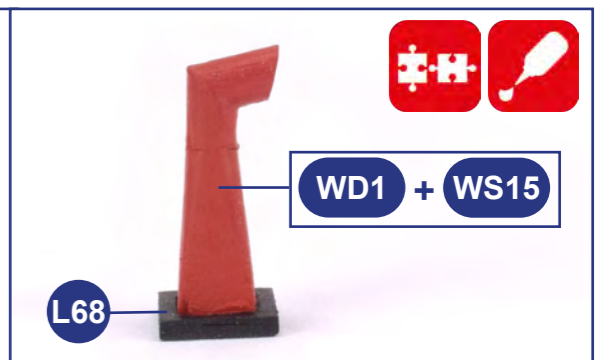
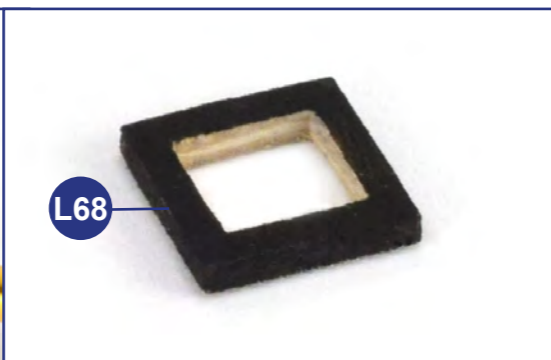
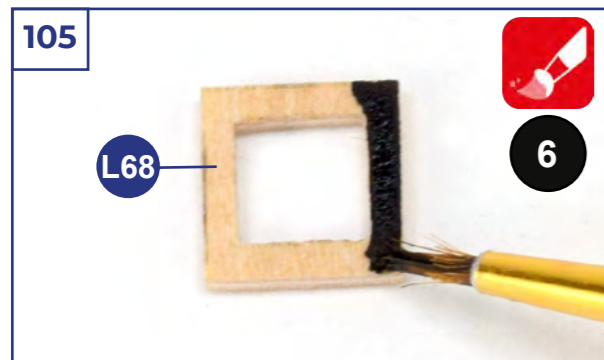
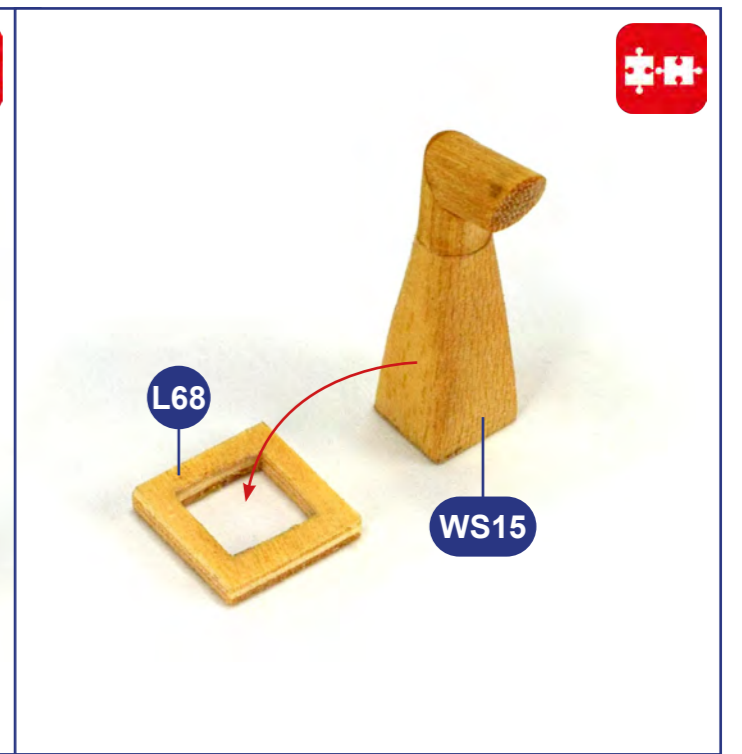
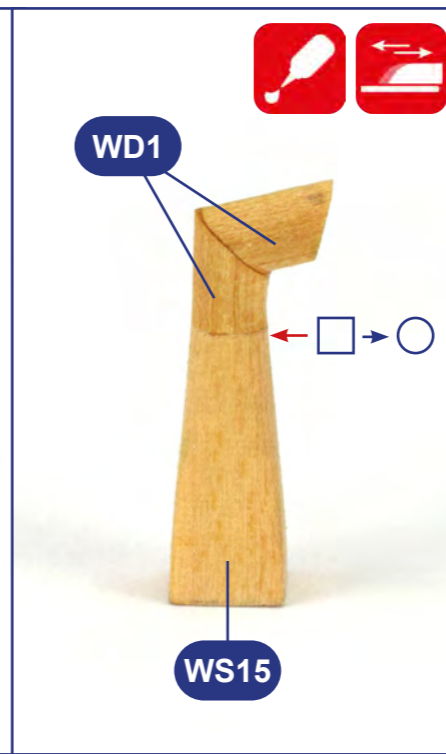
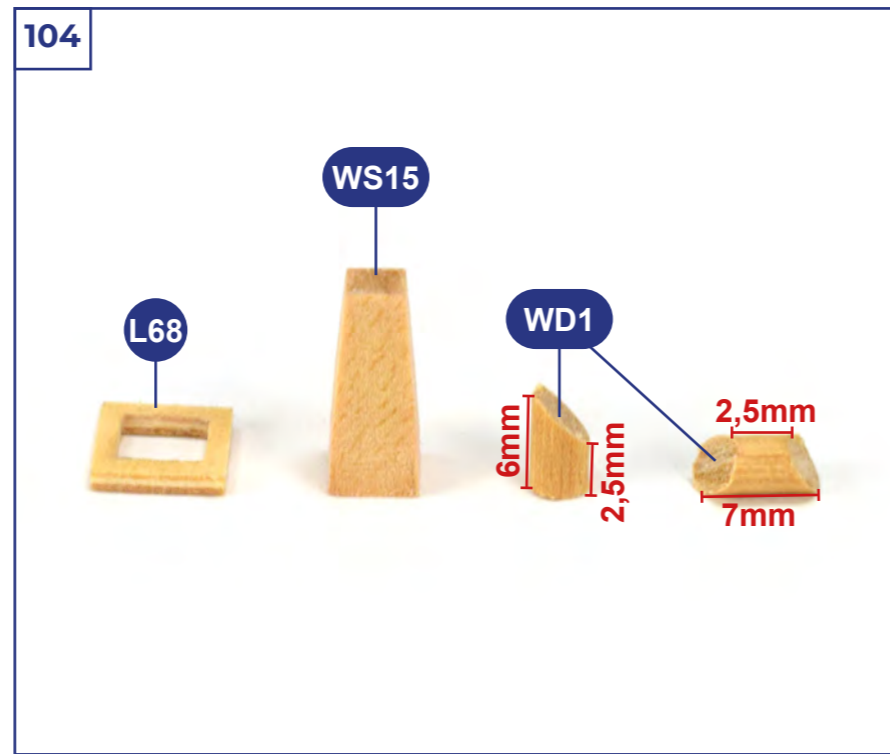
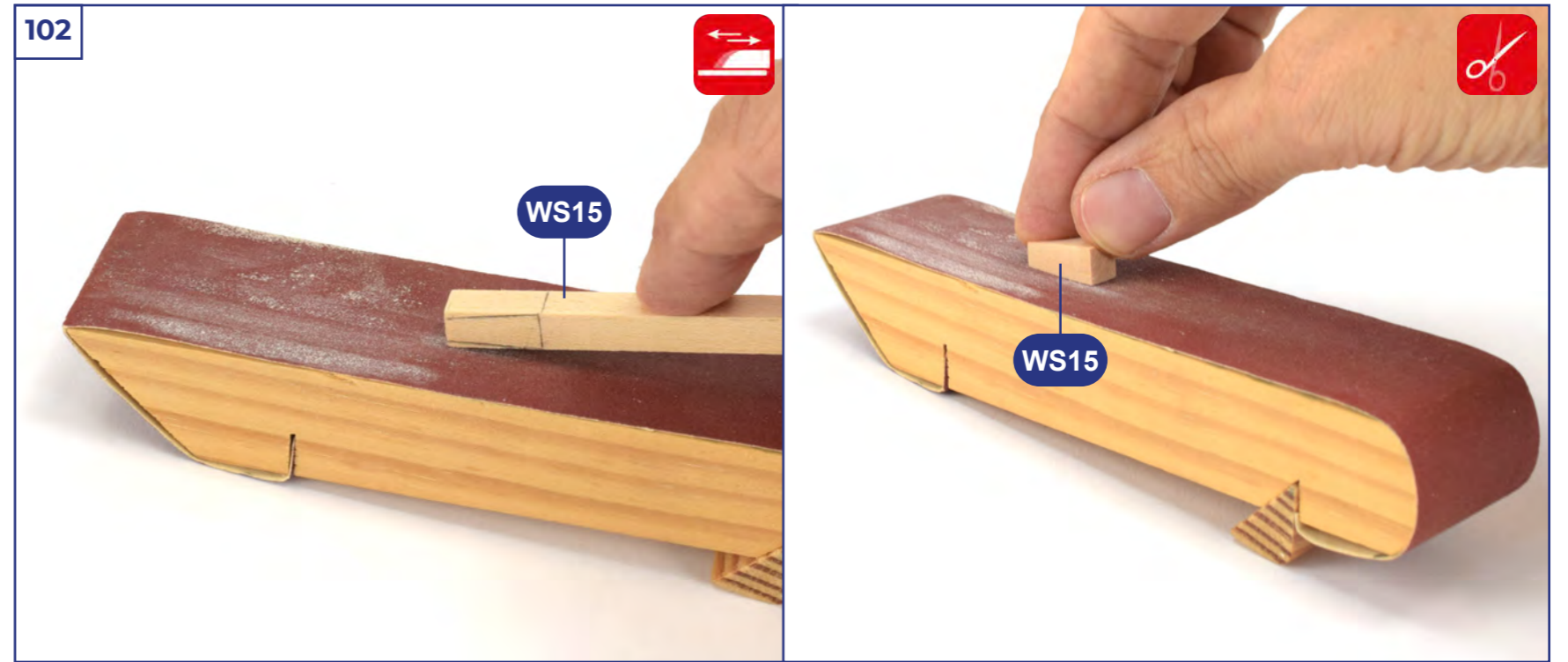
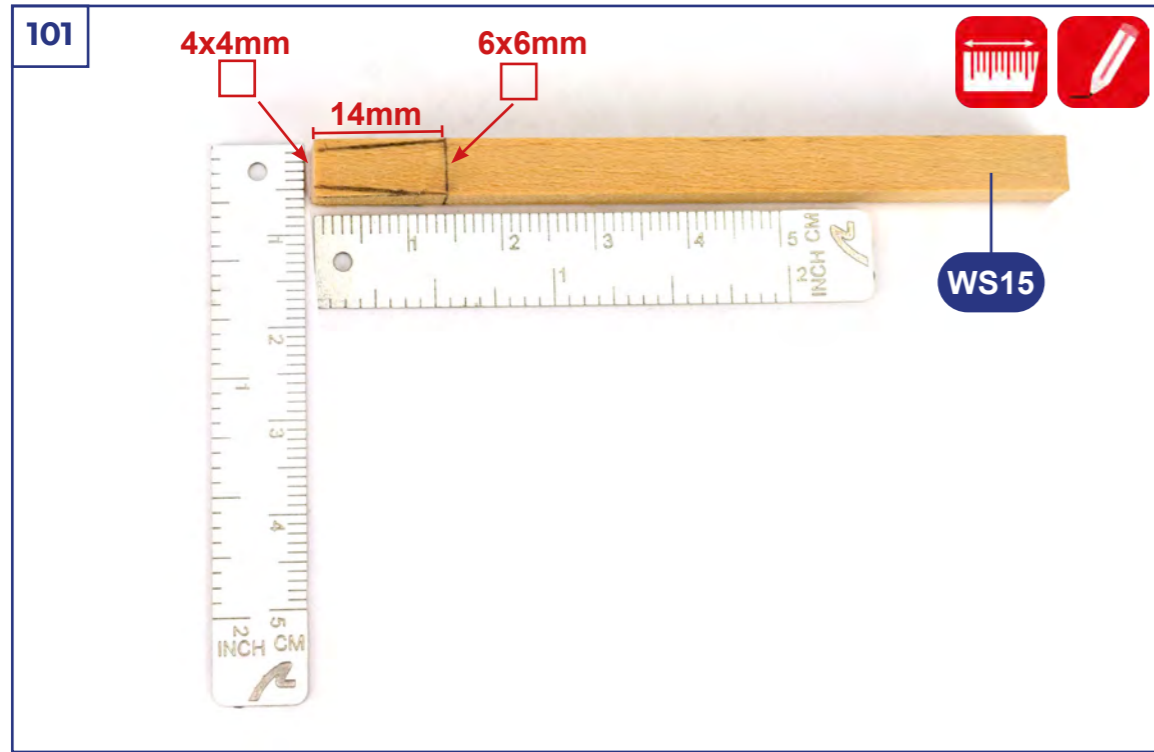

107

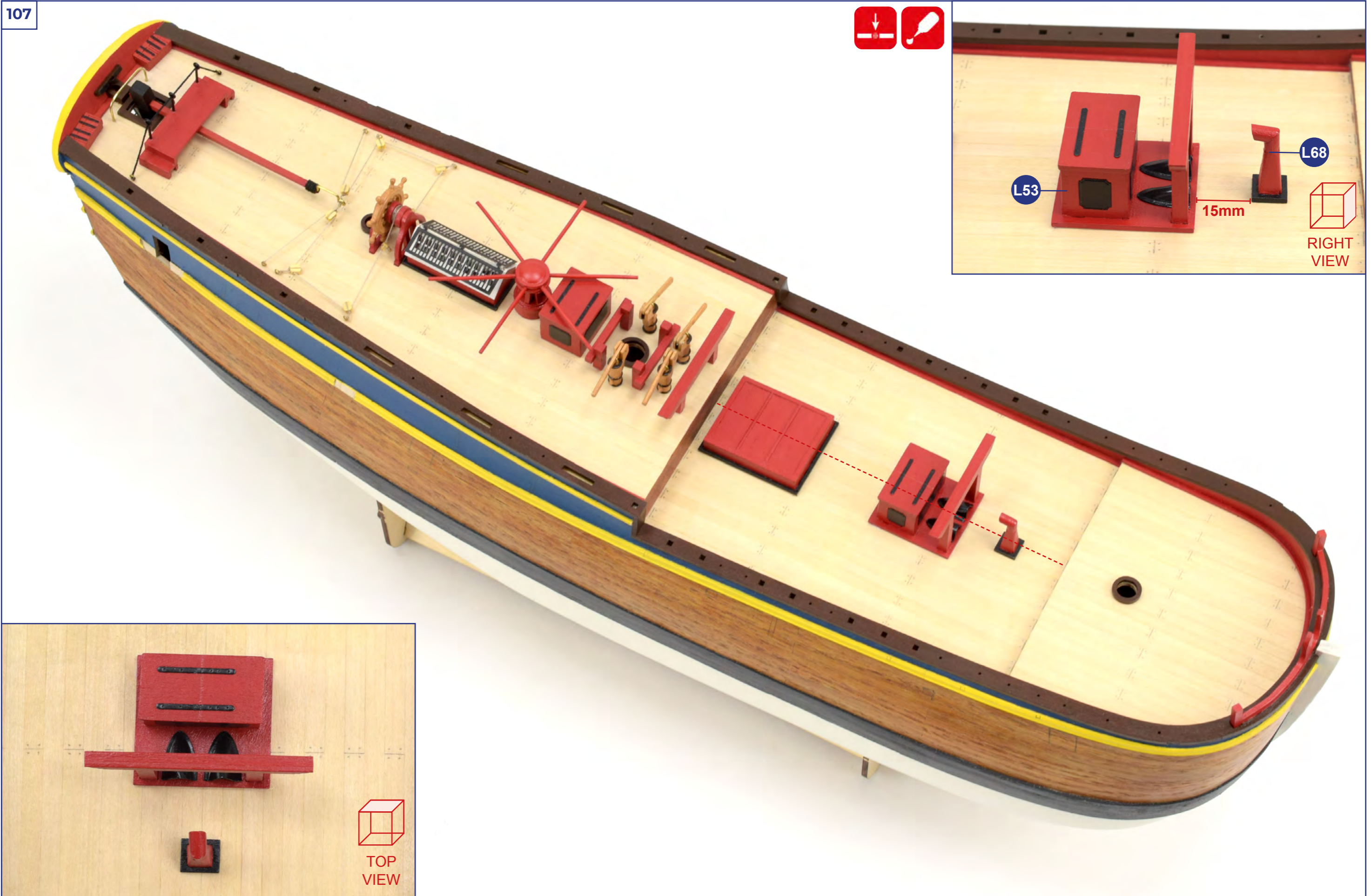
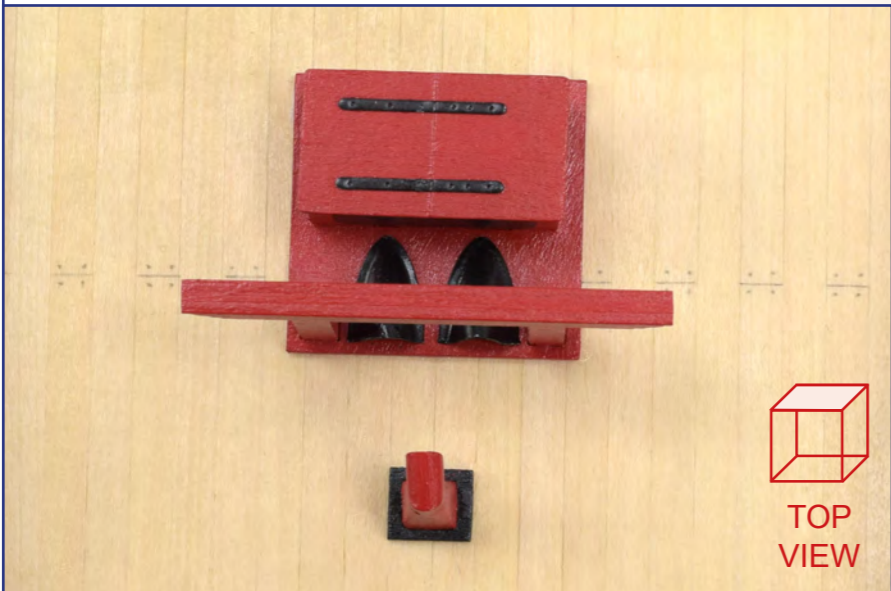
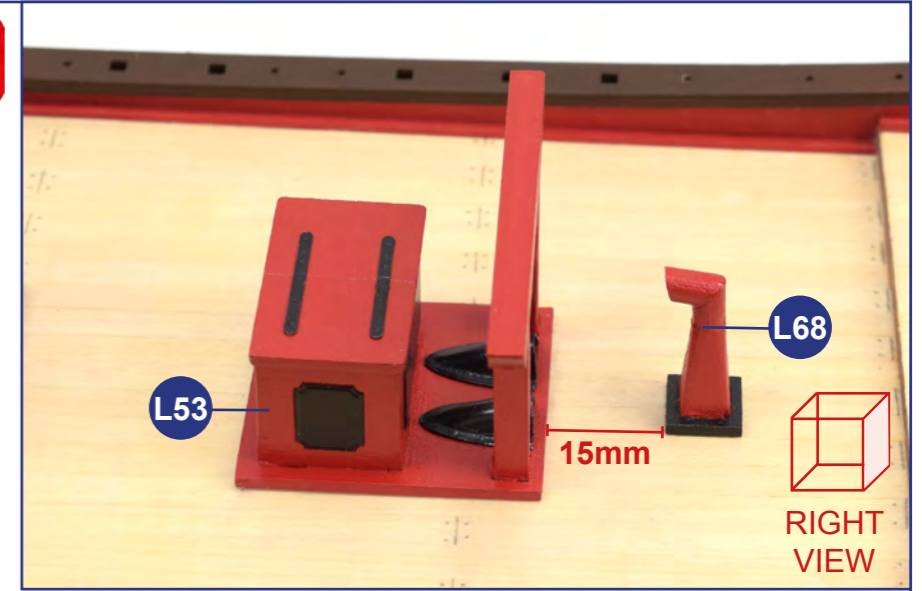

108

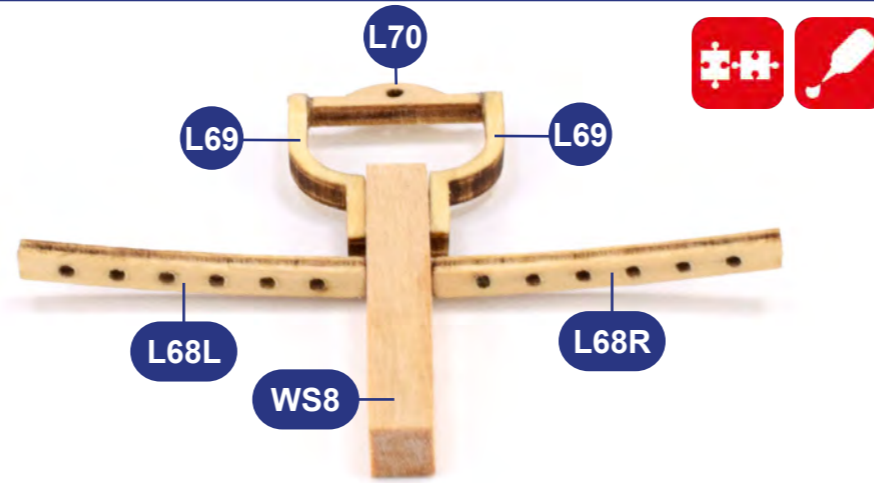
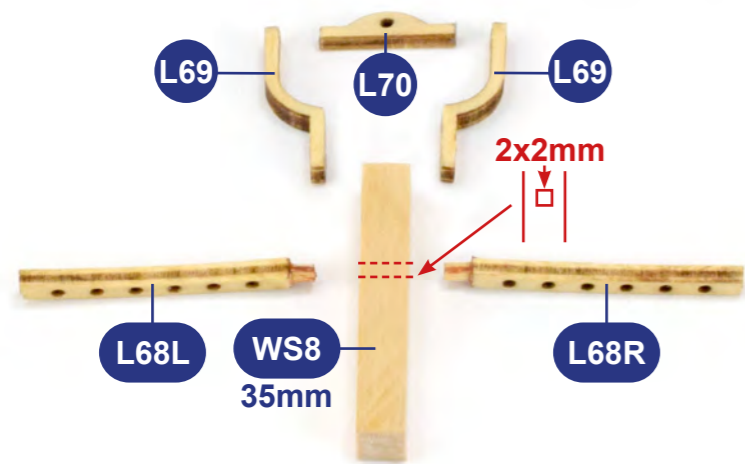

109

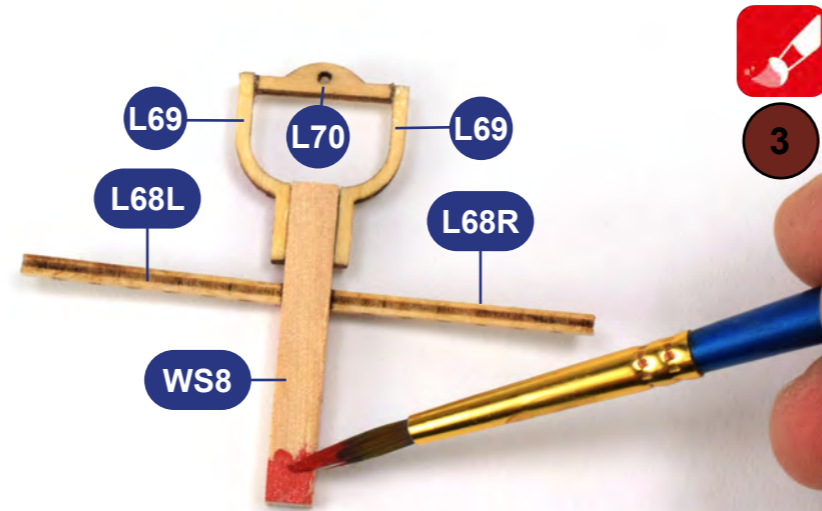

110

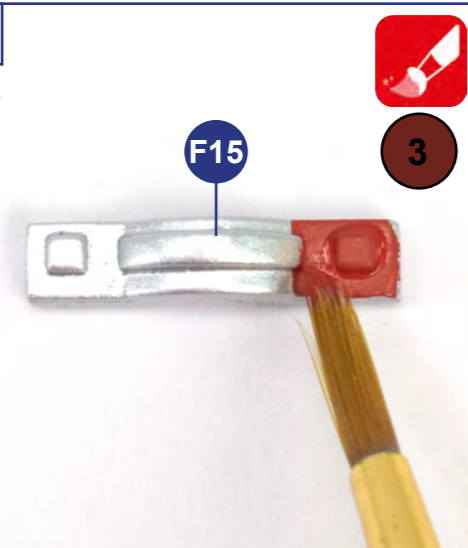

111

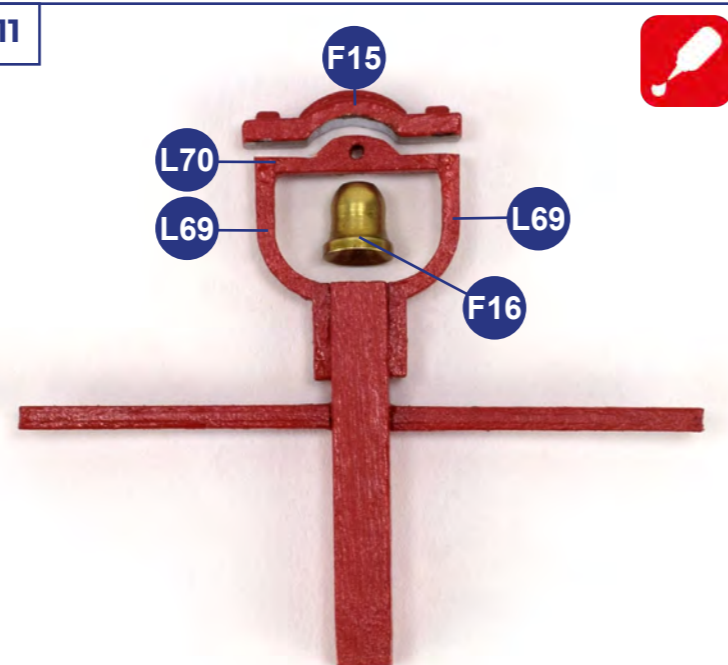

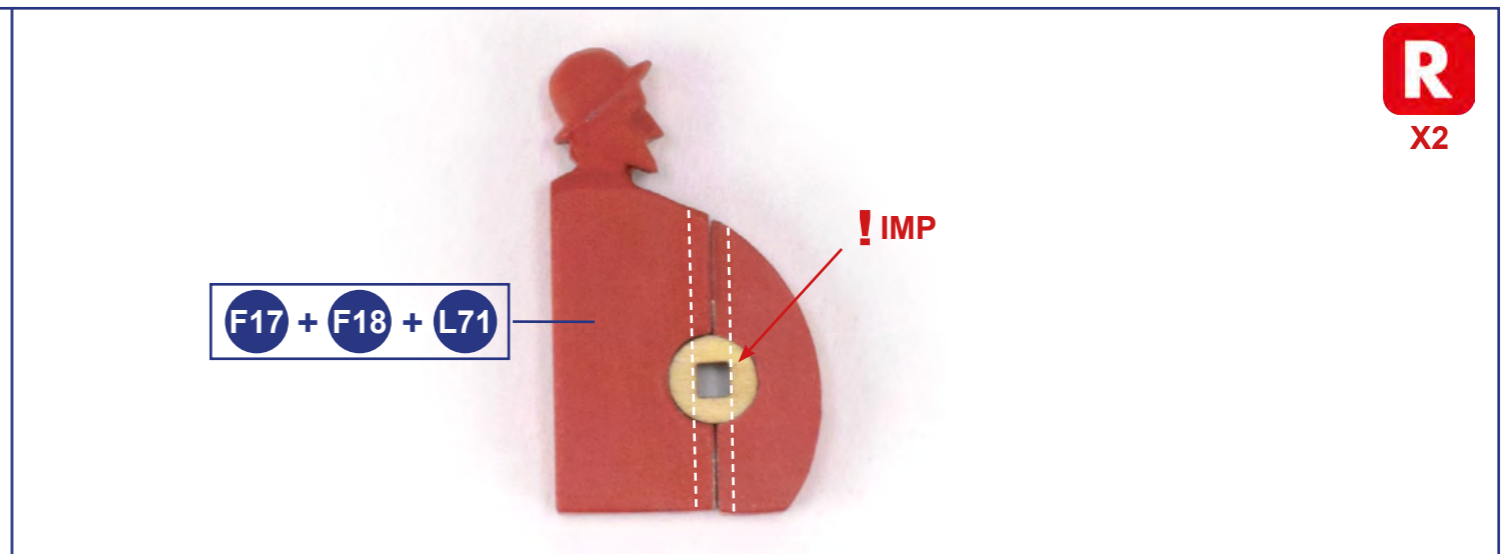
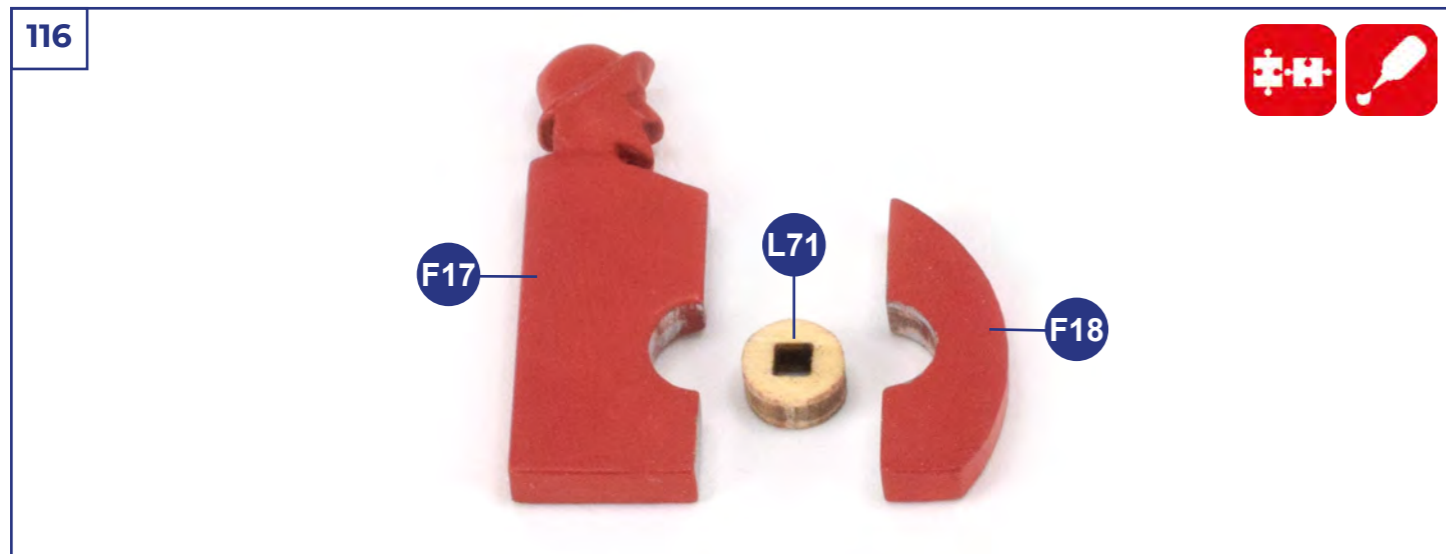
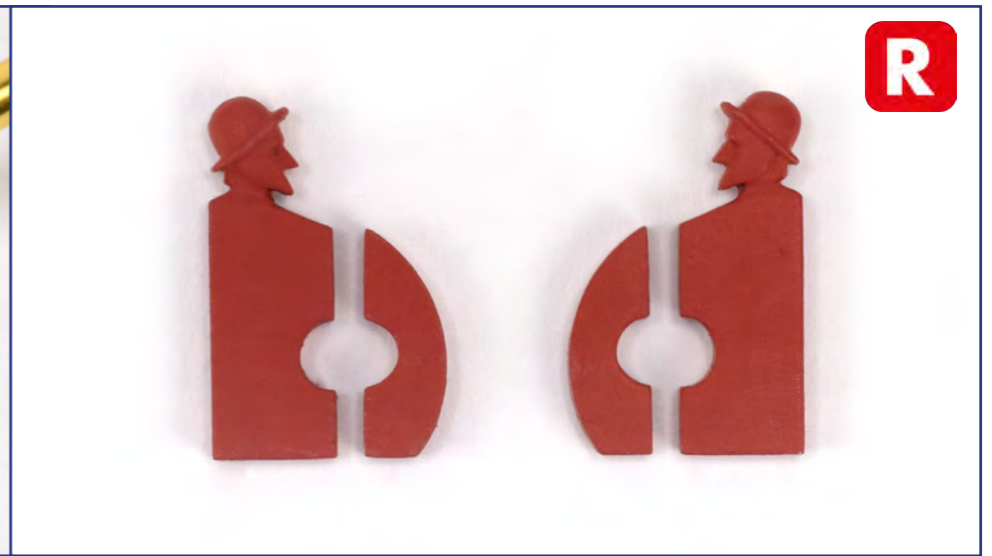
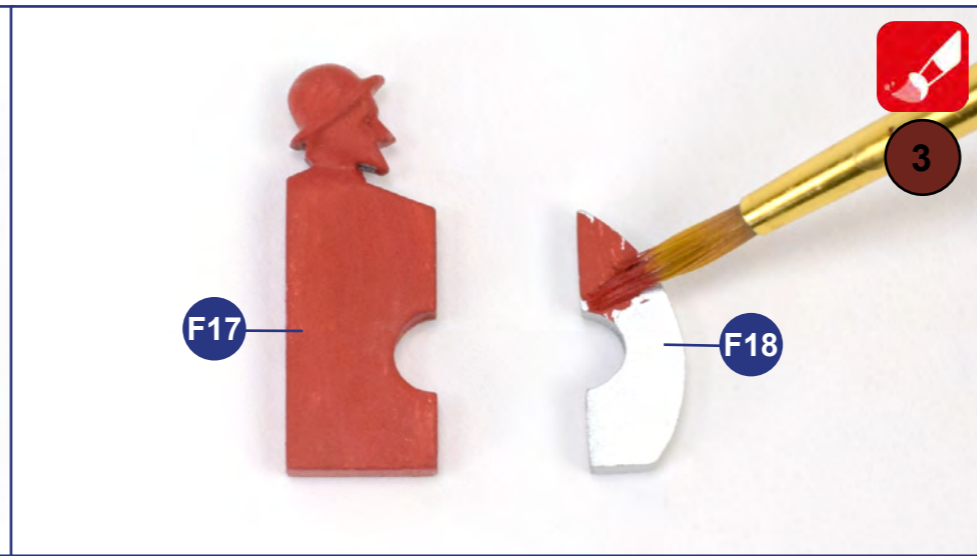
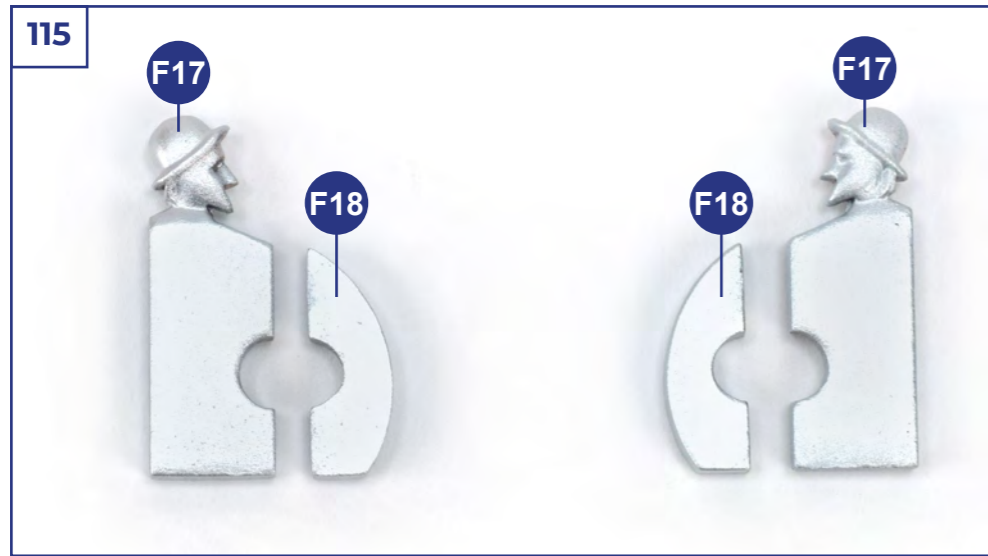
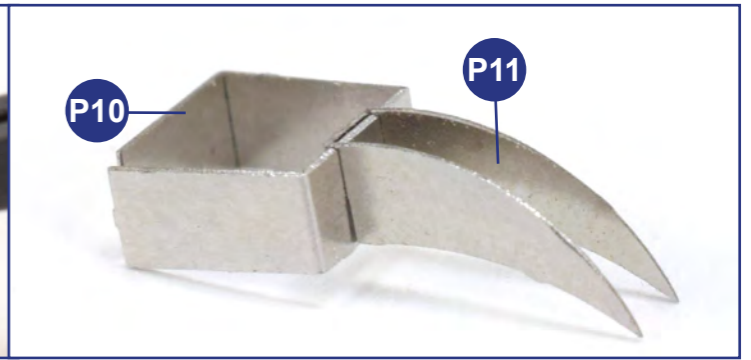
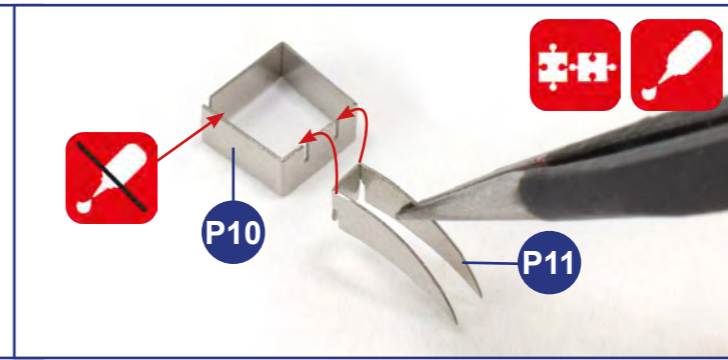
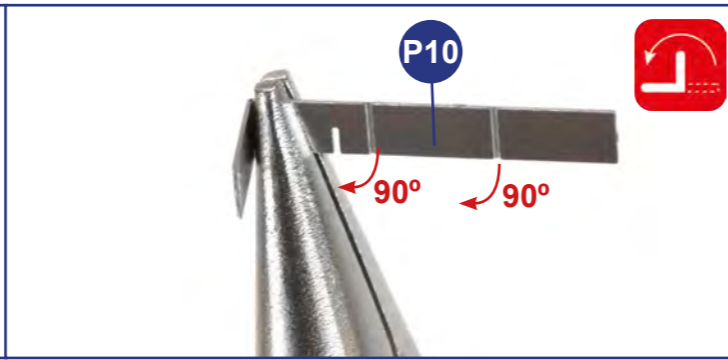
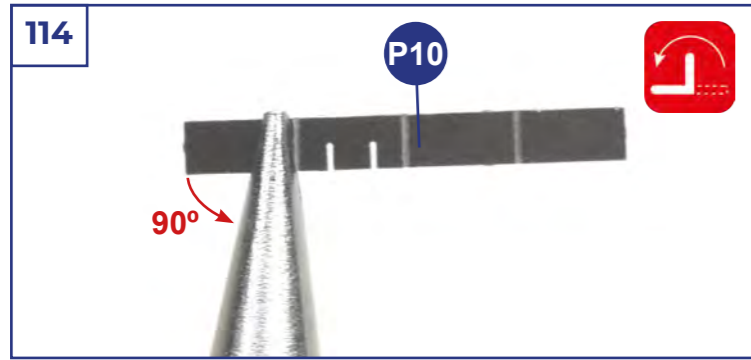
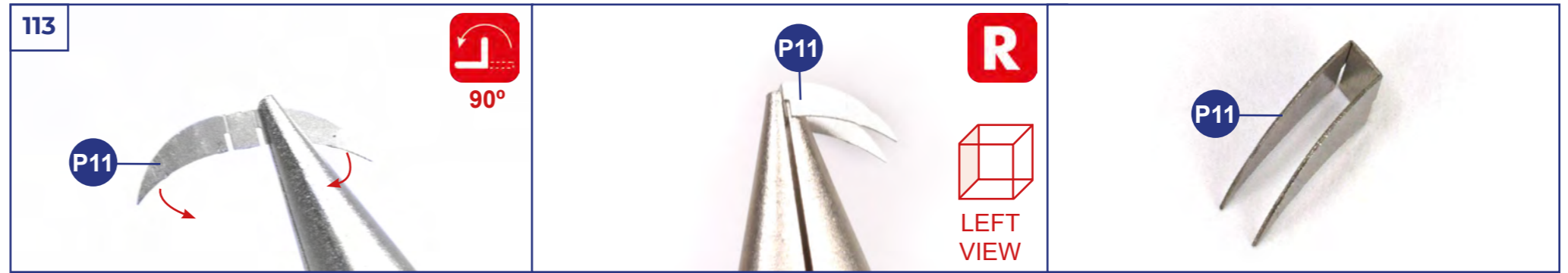
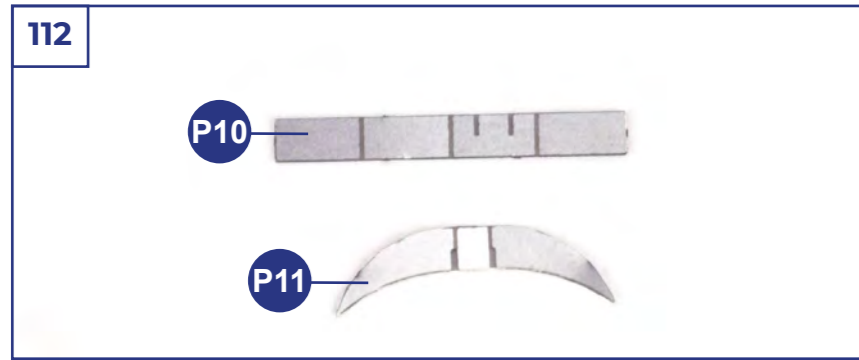

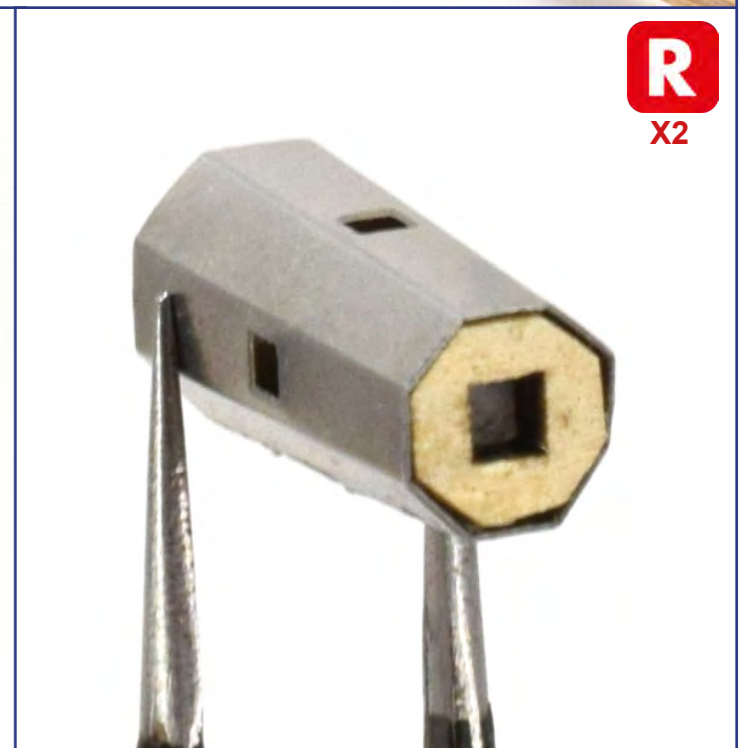
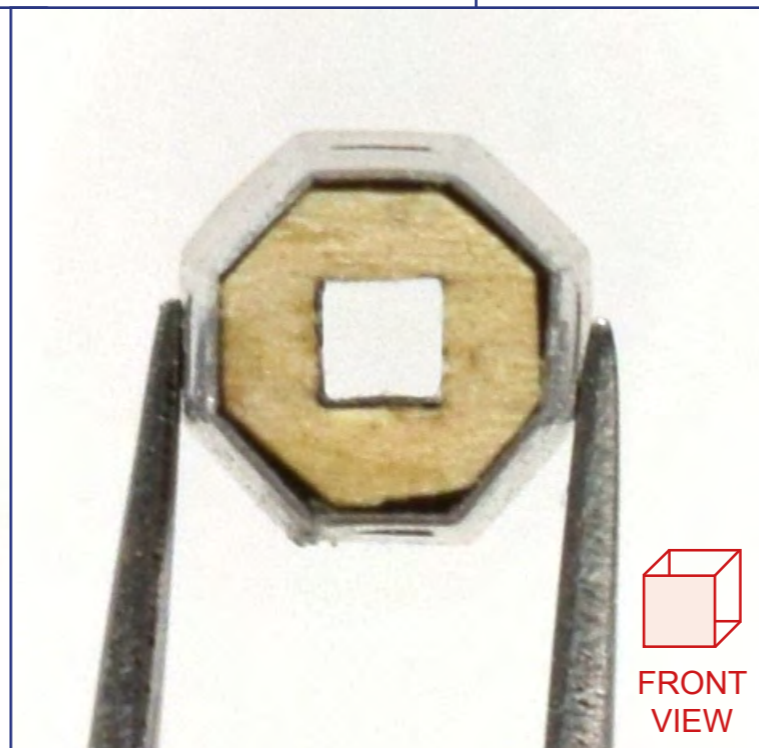
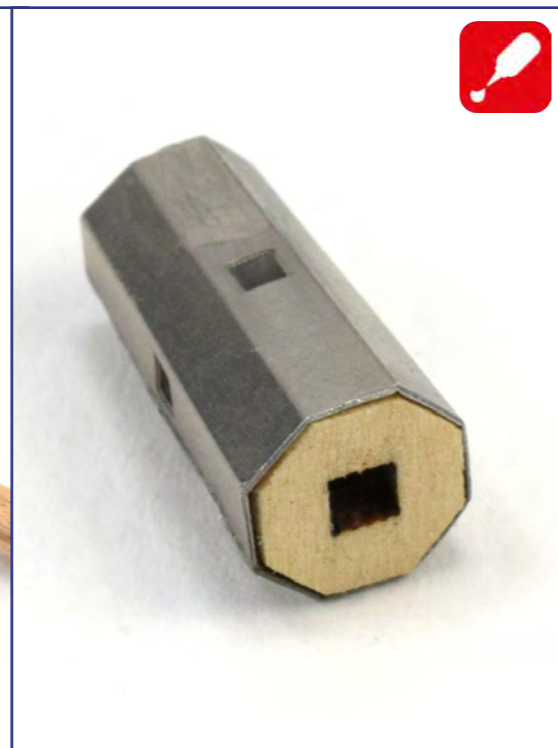
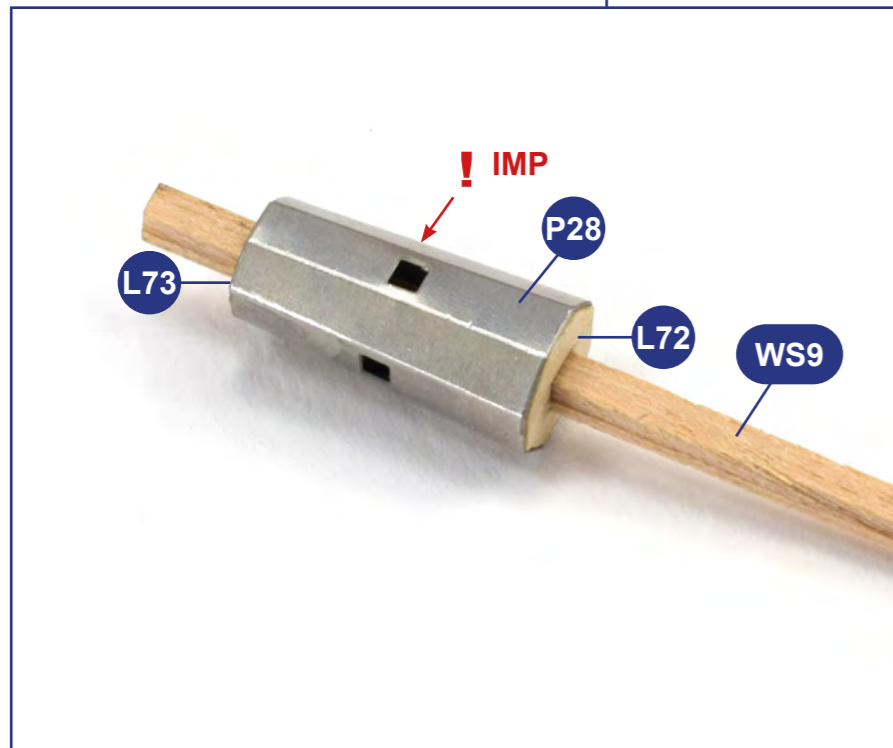
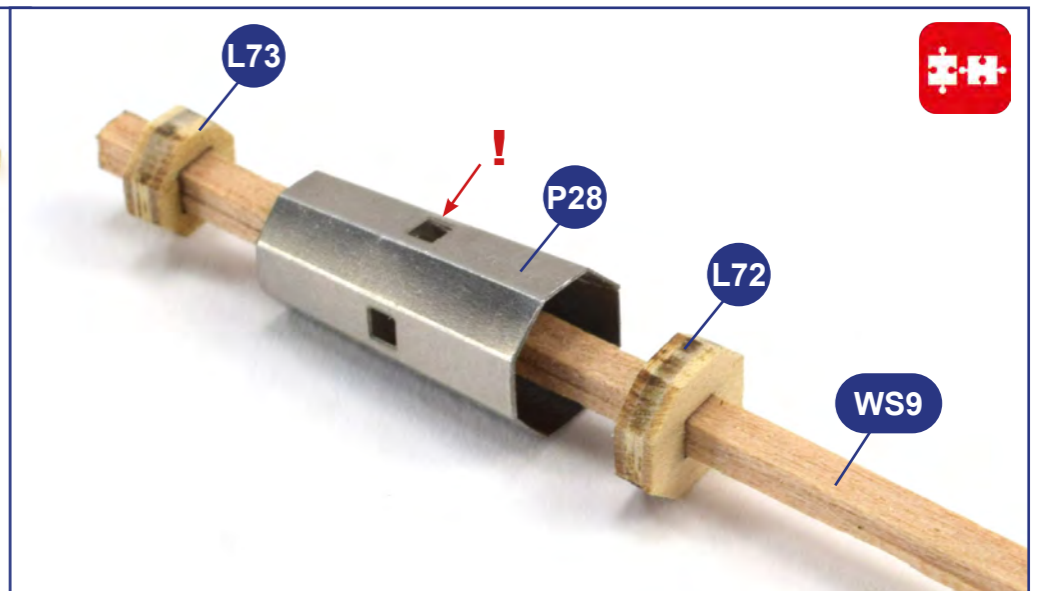
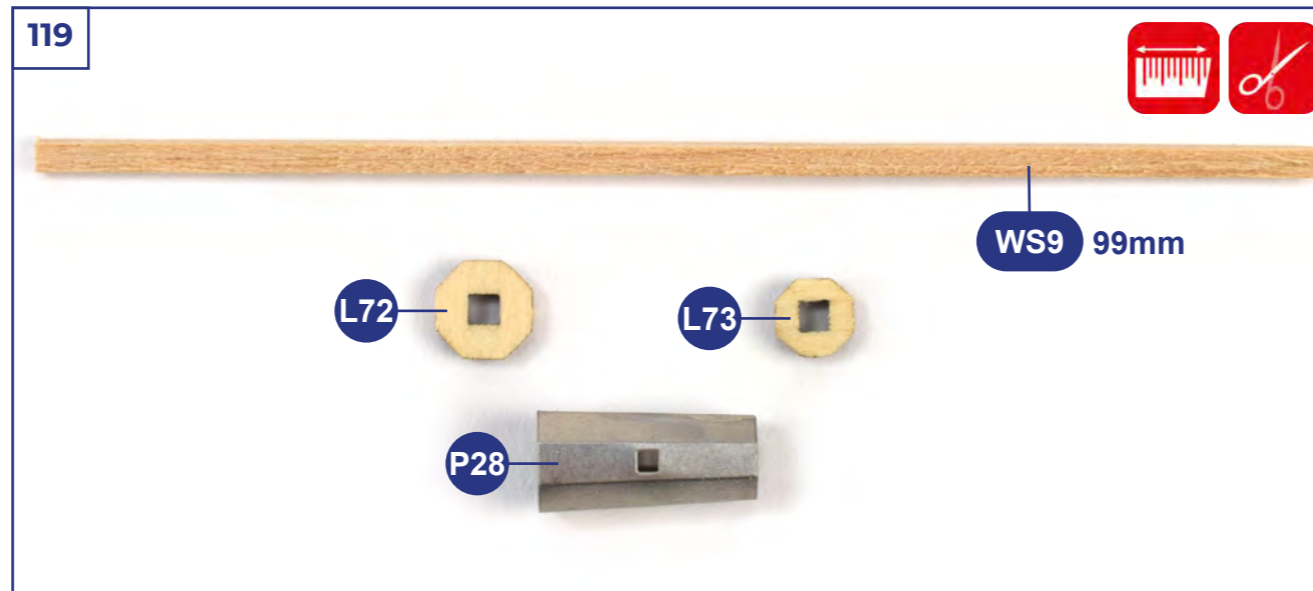
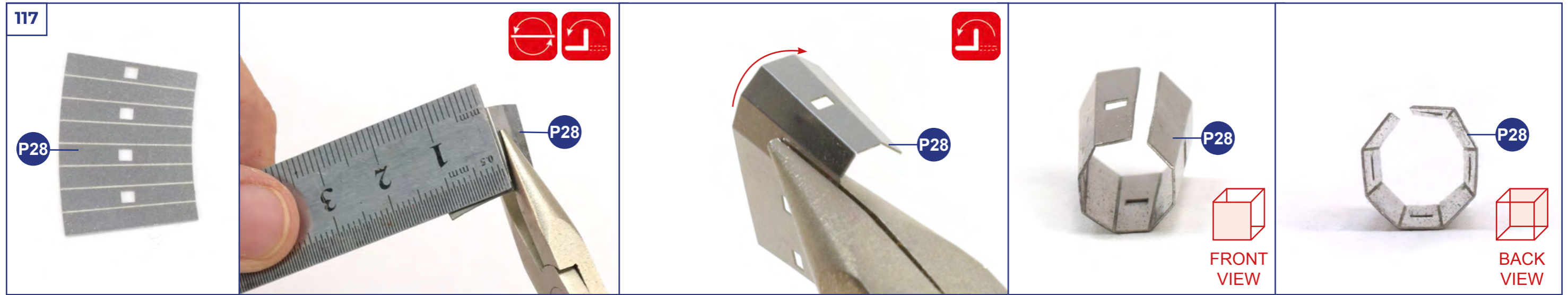

120

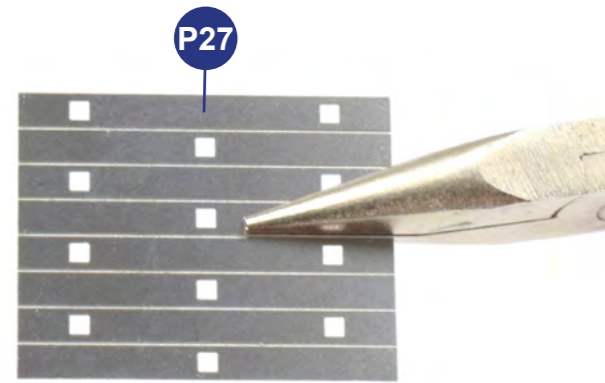

121

P28 + L72 + L73

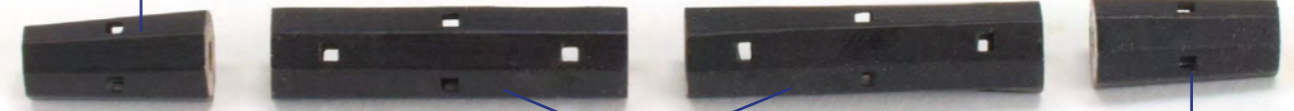

P27 + L72 + L72

P28 + L72 + L73



6

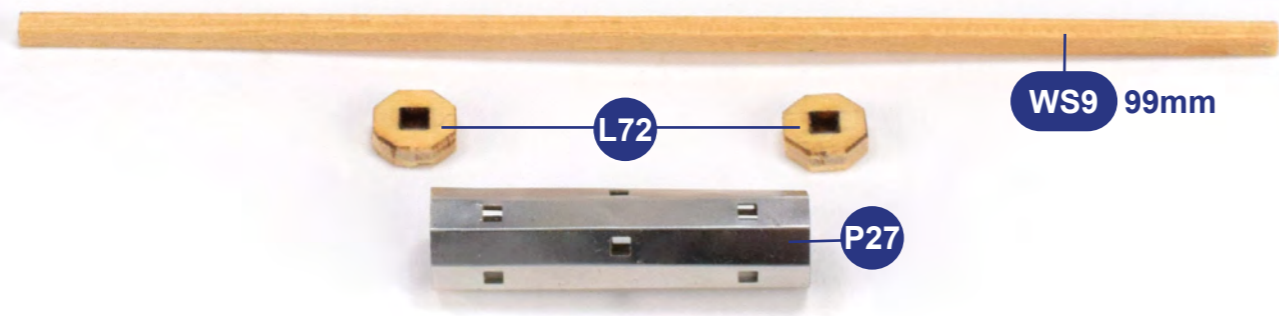

122

WS9 99mm

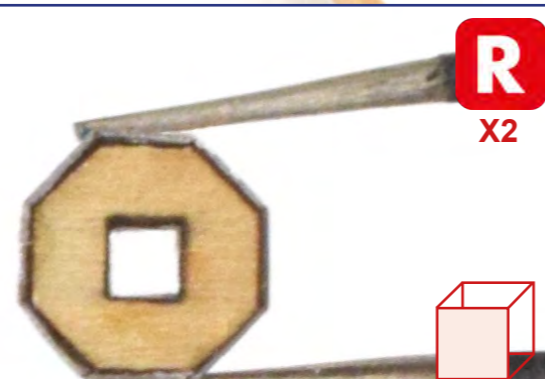
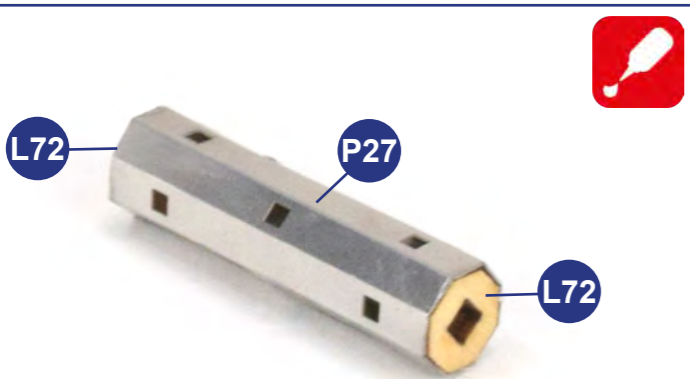
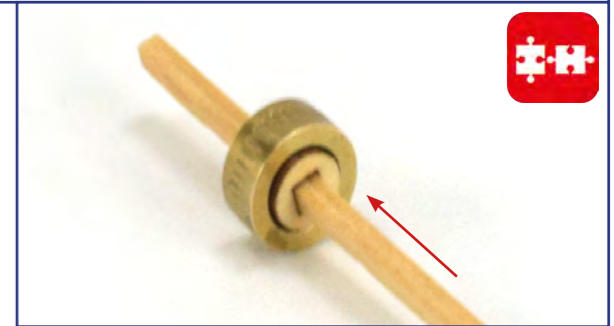
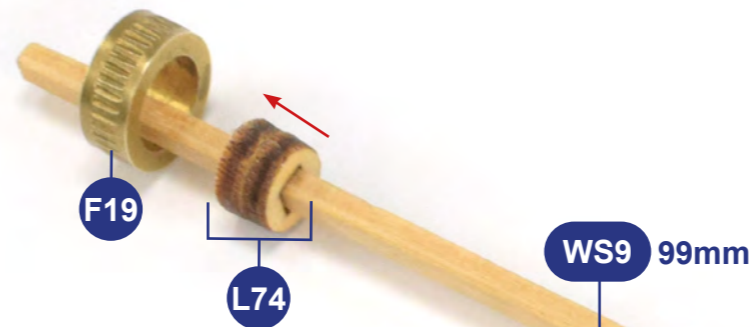
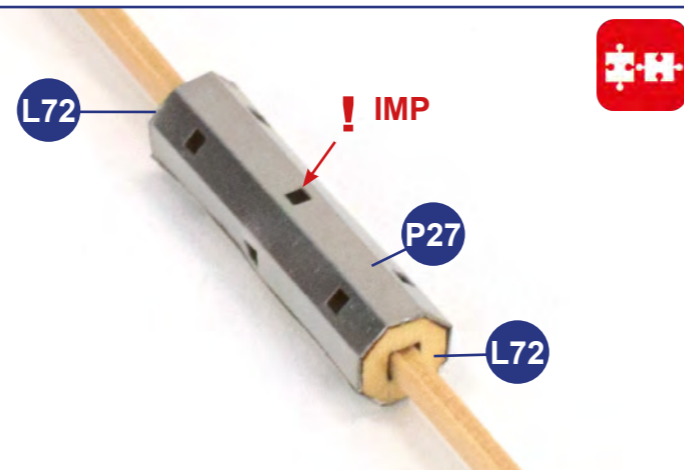

FRONT VIEW

F19 + L74 X2



123

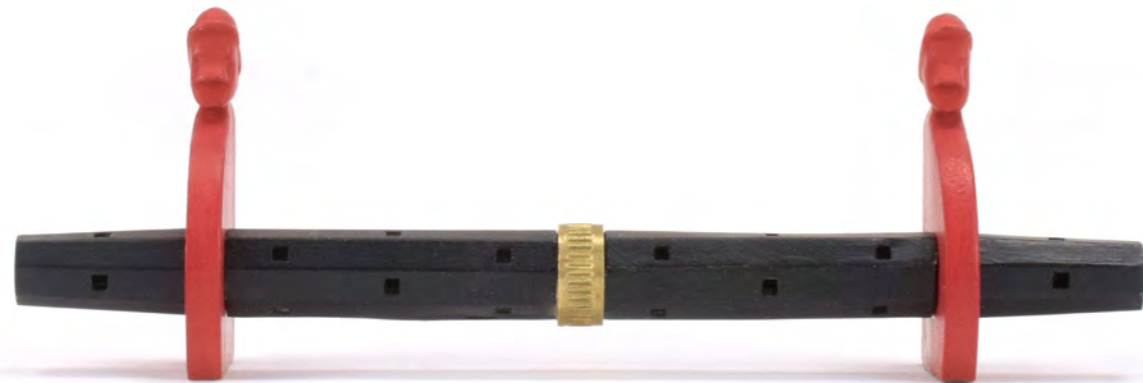
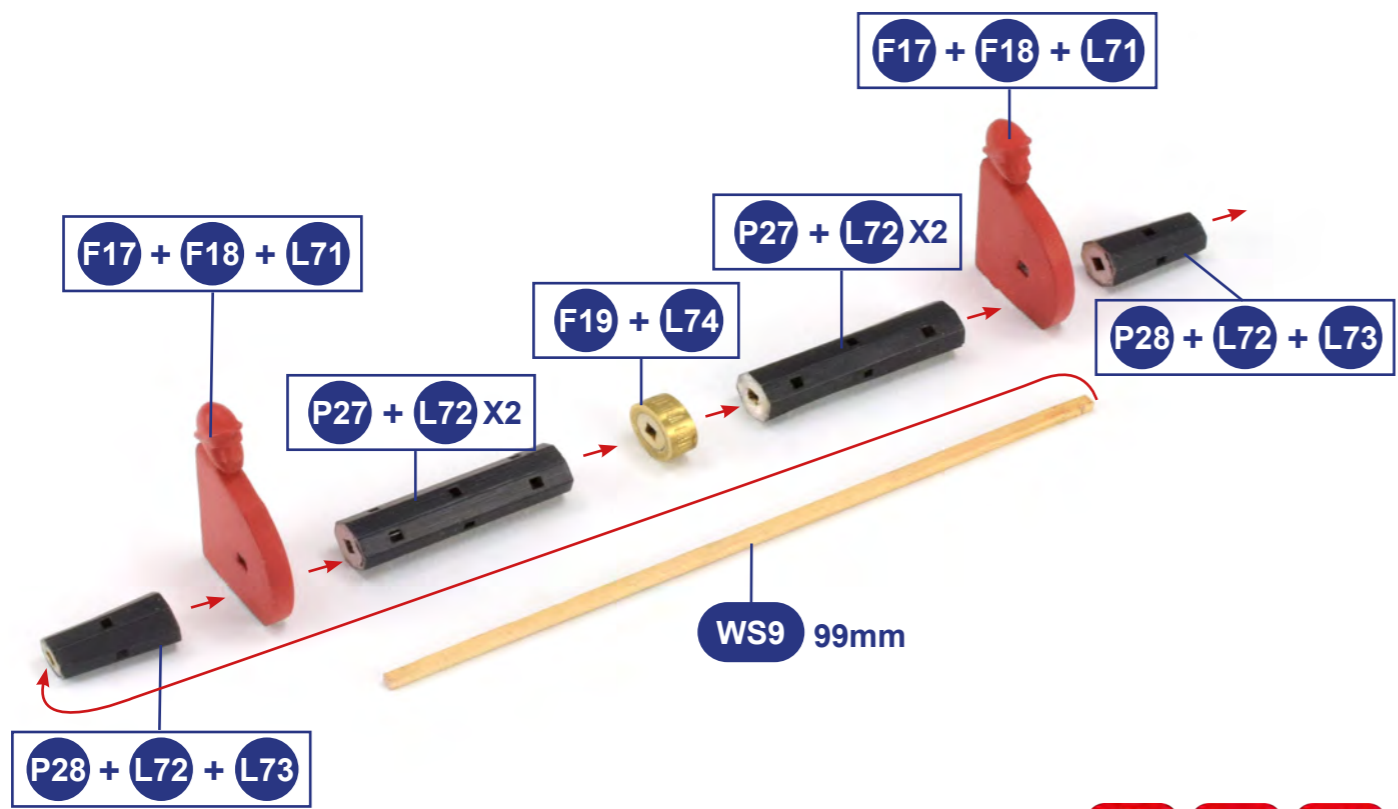

FRONT VIEW

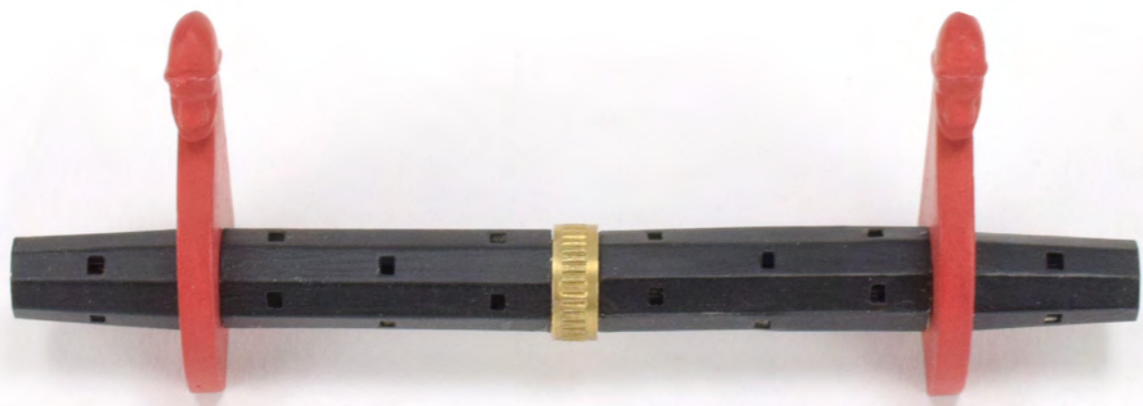

TOP VIEW

124

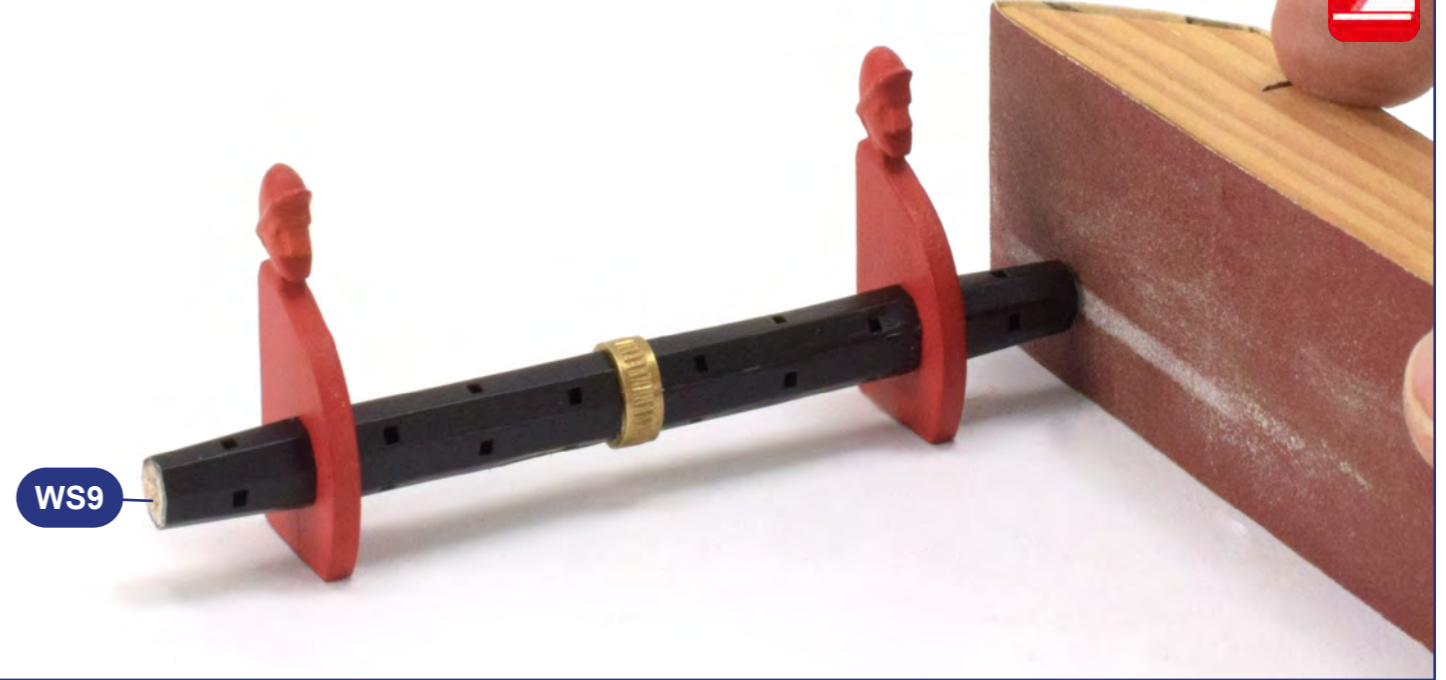

WS9

125

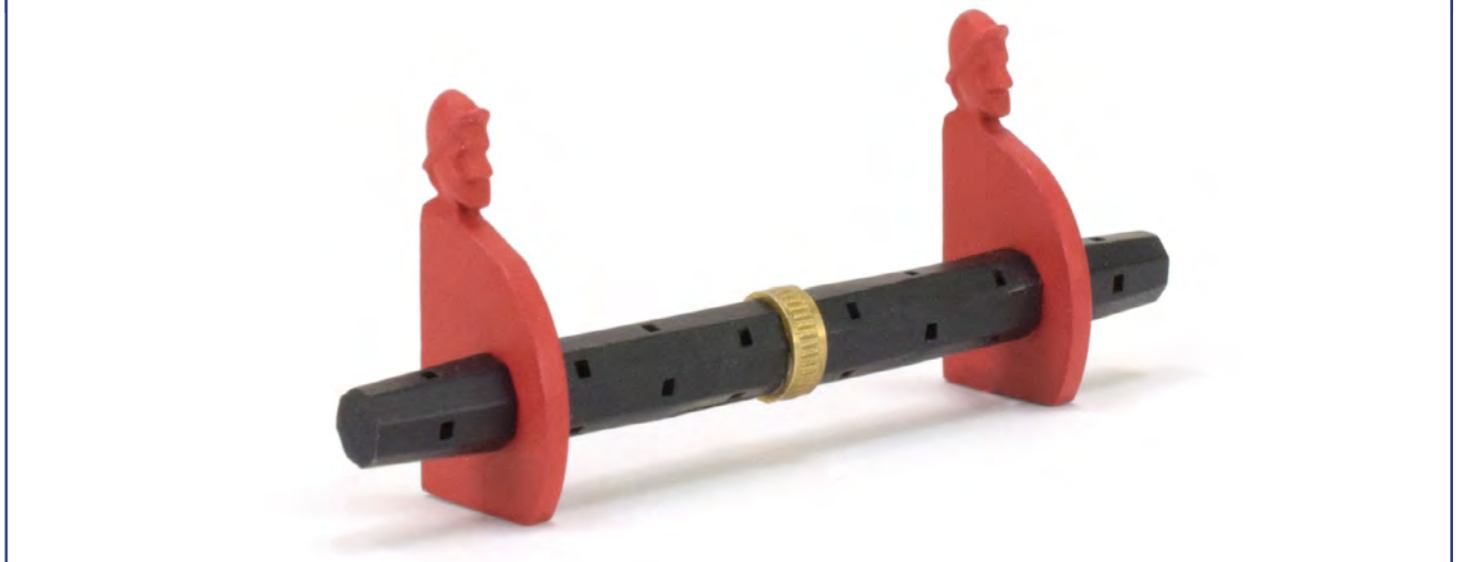
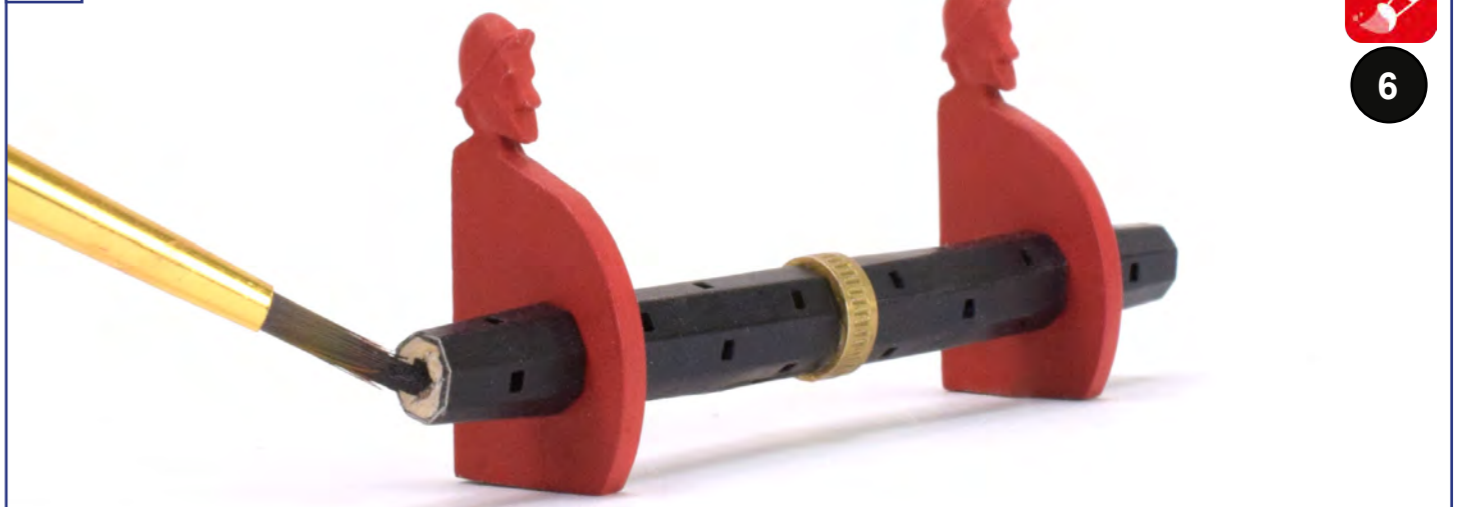

126

WS13
25mm

2mm 23mm

WS13

3

127

P27 + L72 X2

WS13

WS13

R

WS13

D

TOP VIEW

FRONT VIEW

128

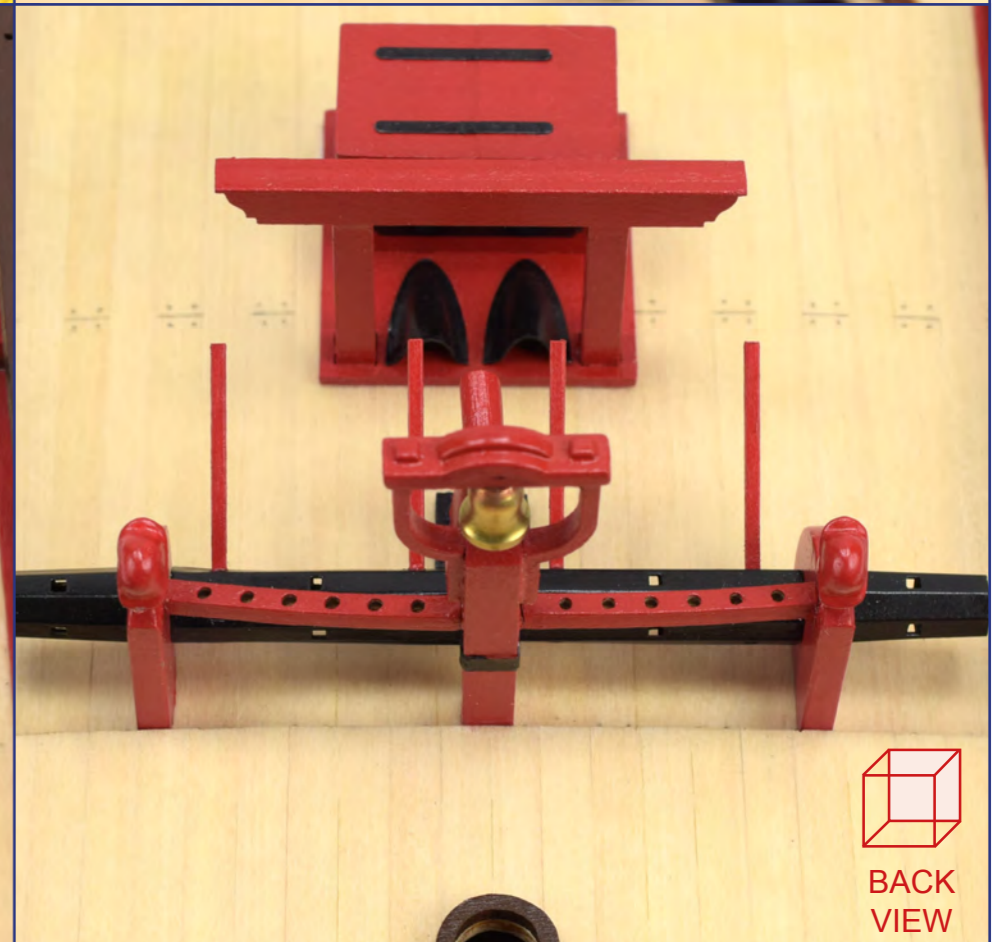
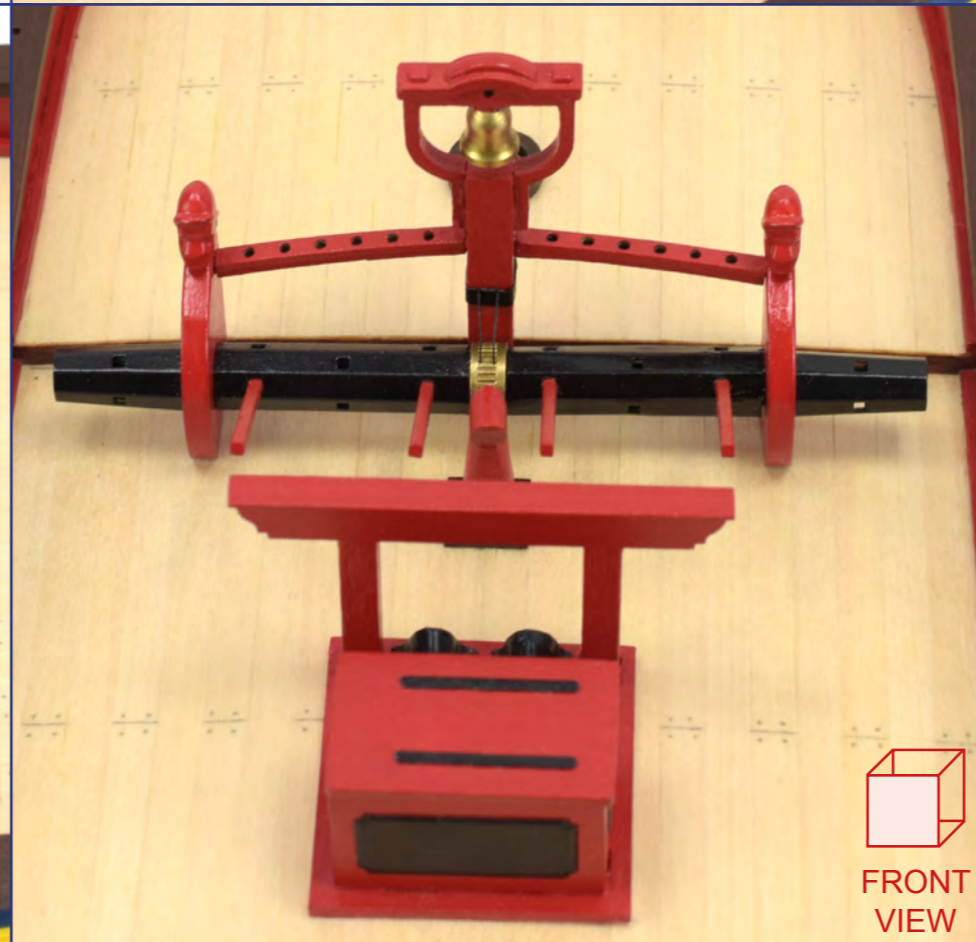
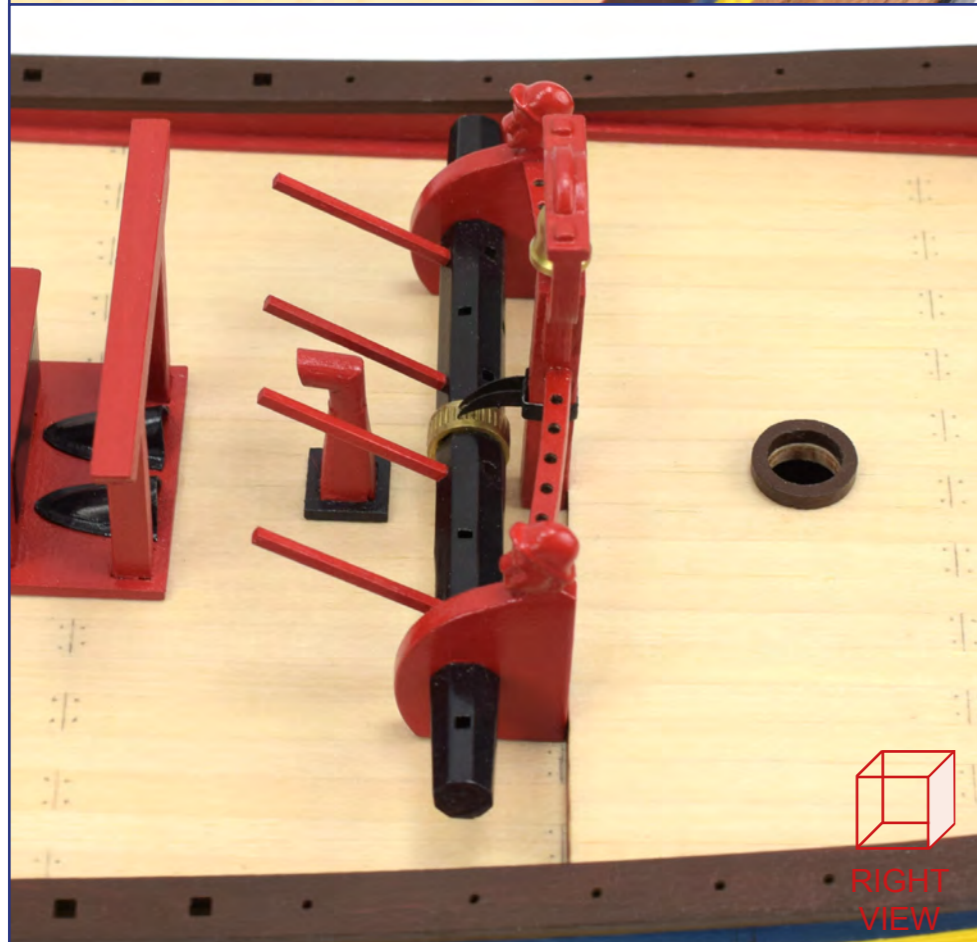
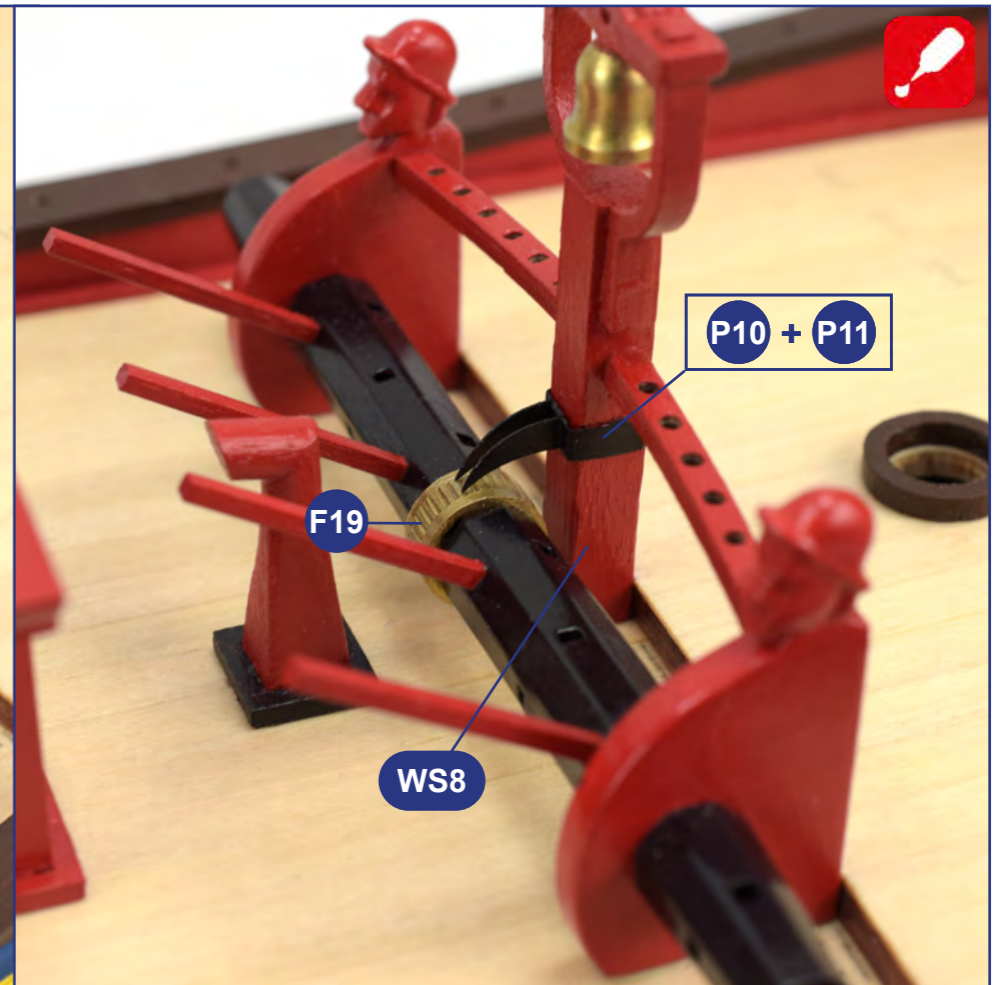
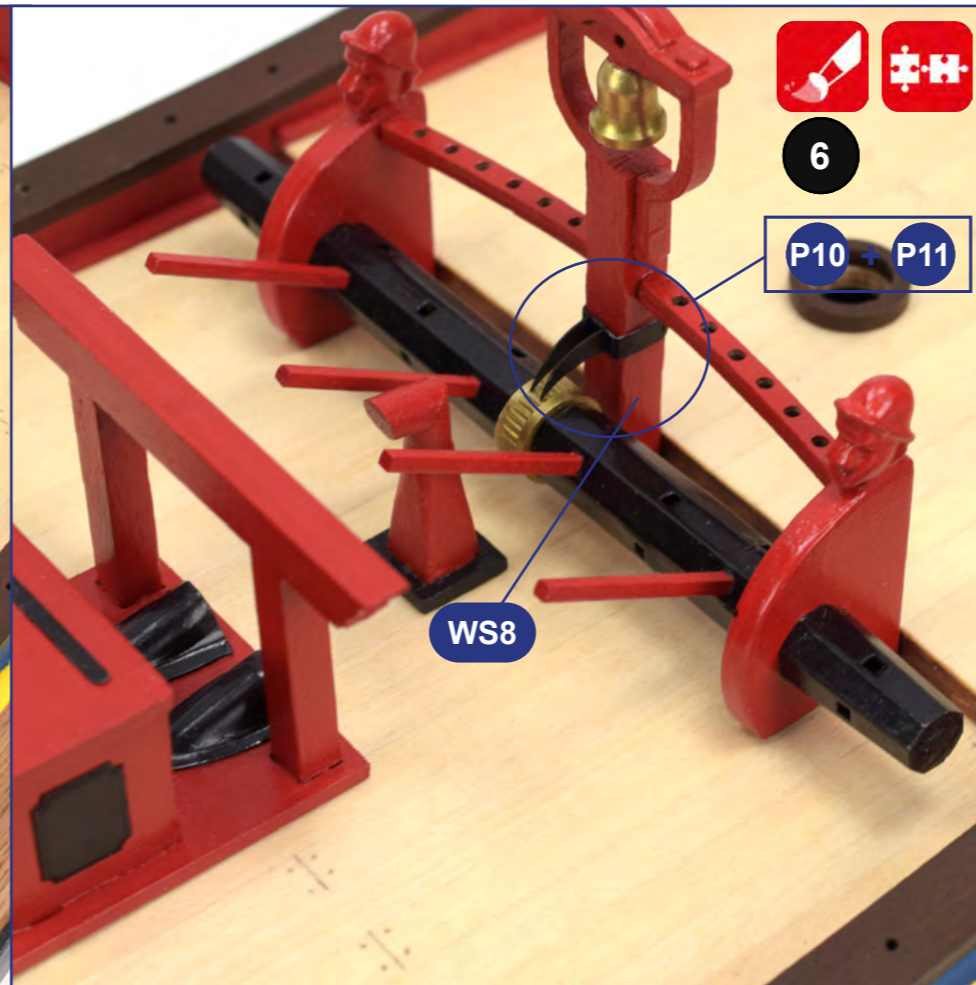
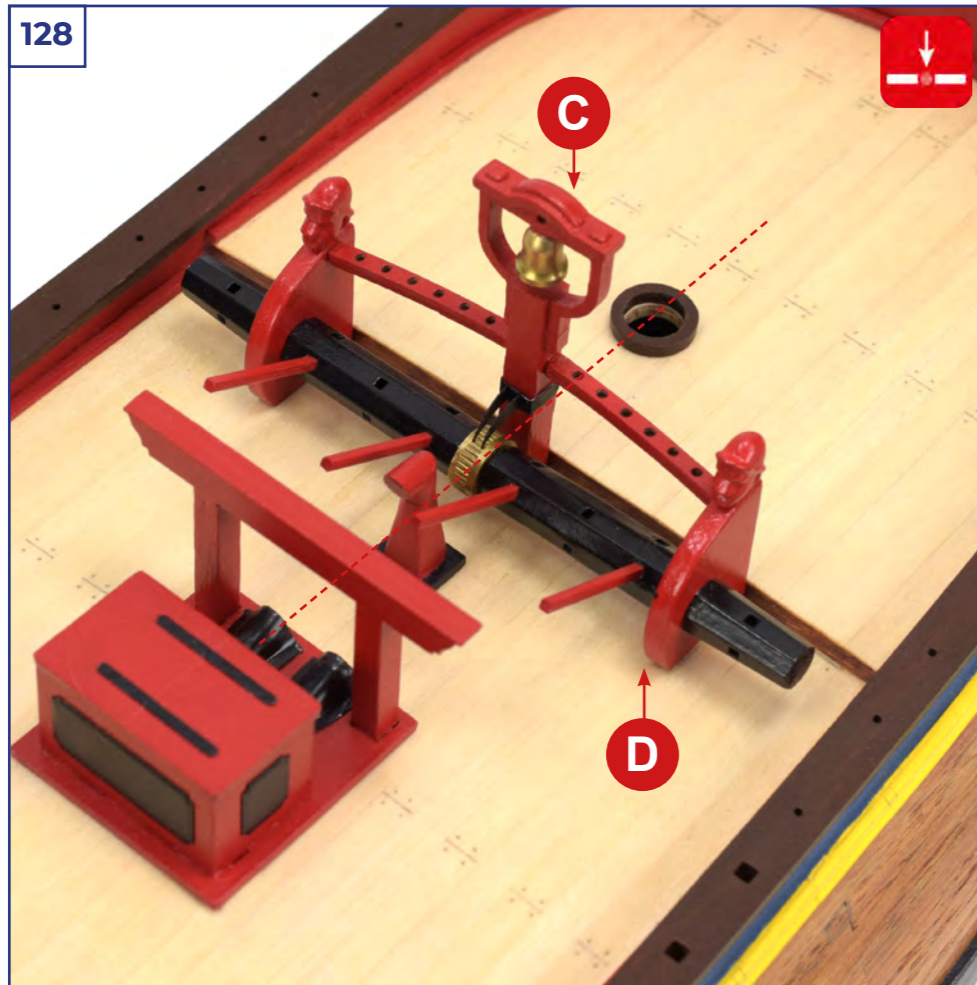

RIGHT VIEW

FRONT VIEW

BACK VIEW

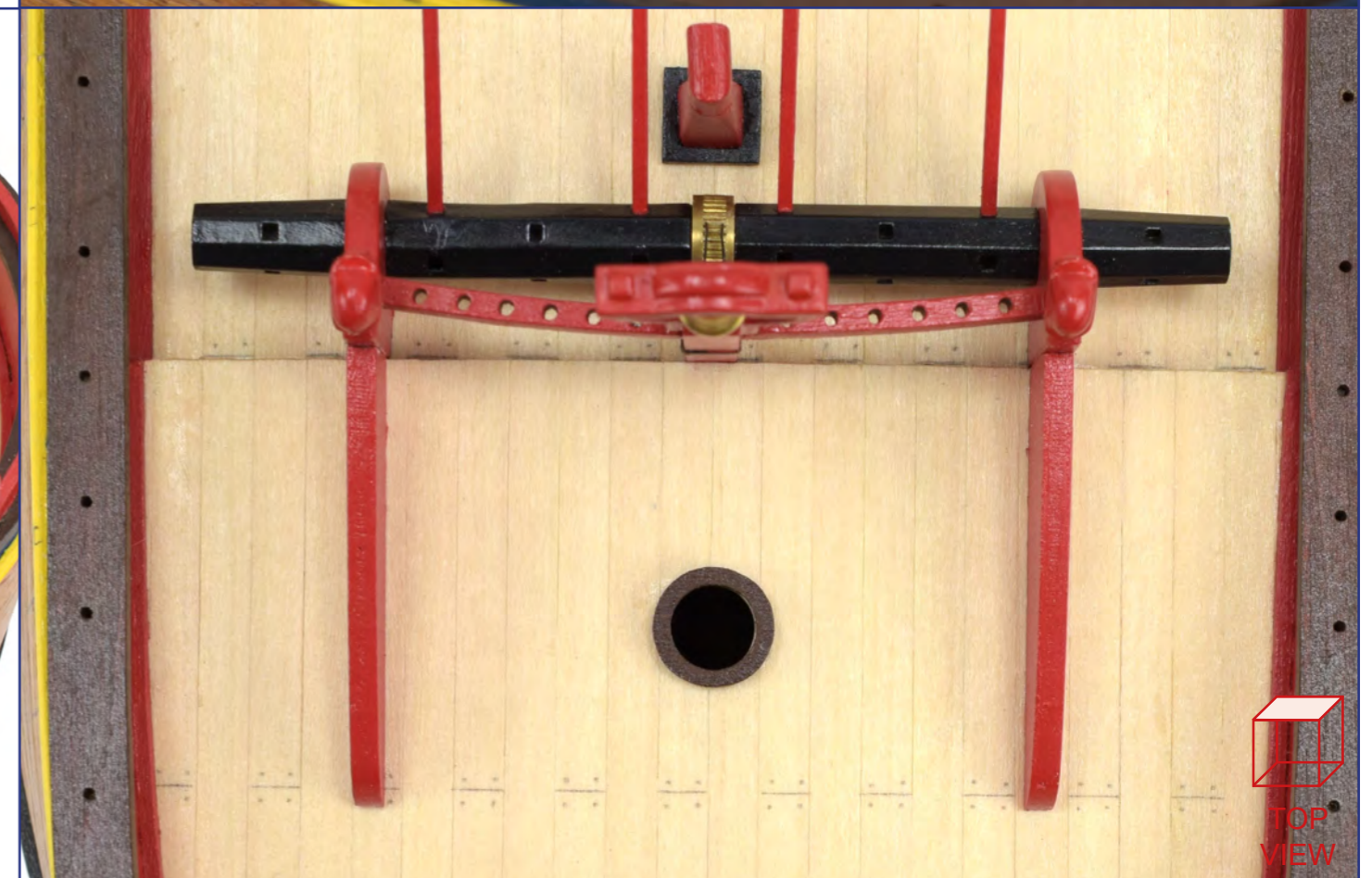
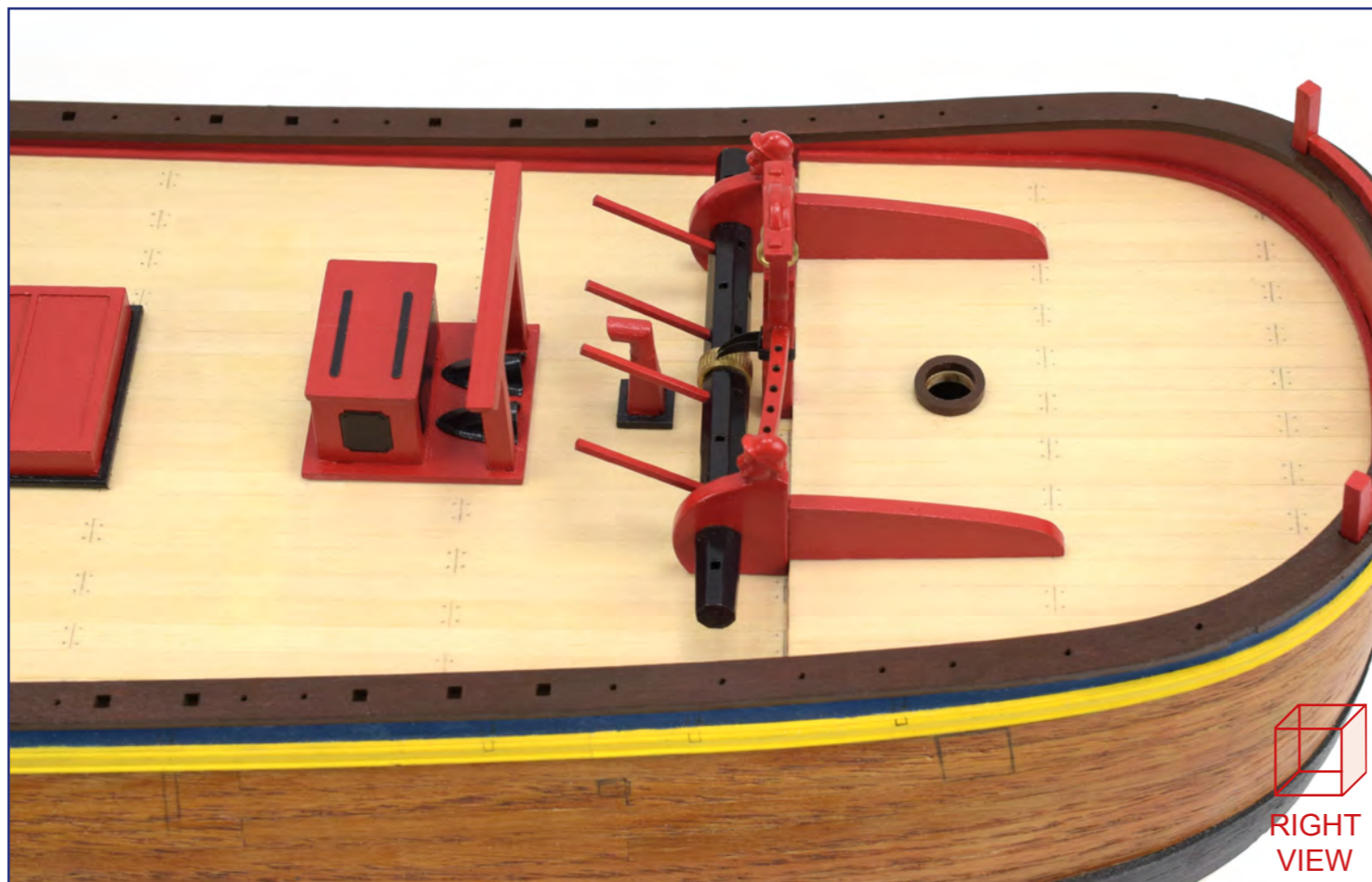
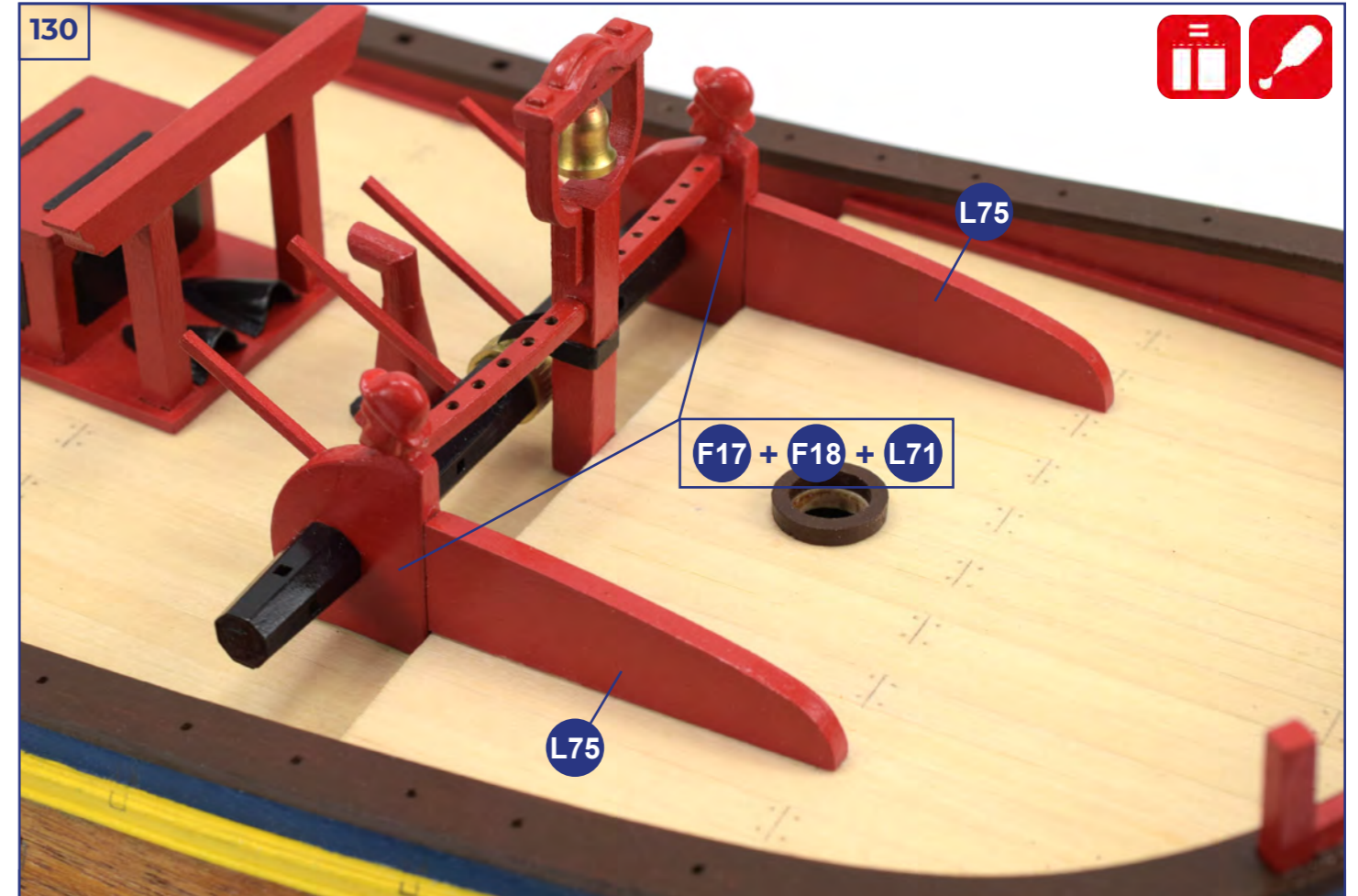
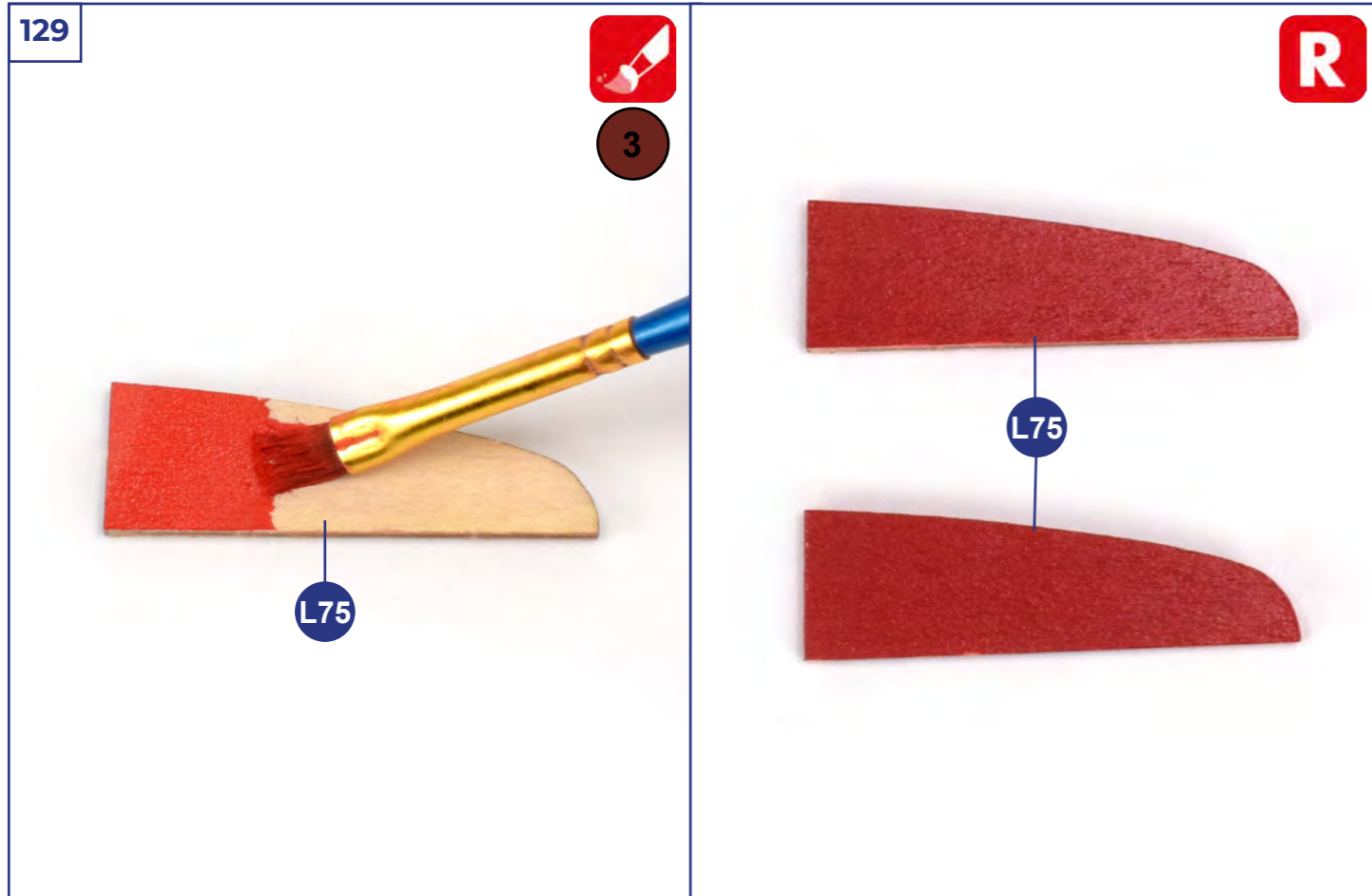

131

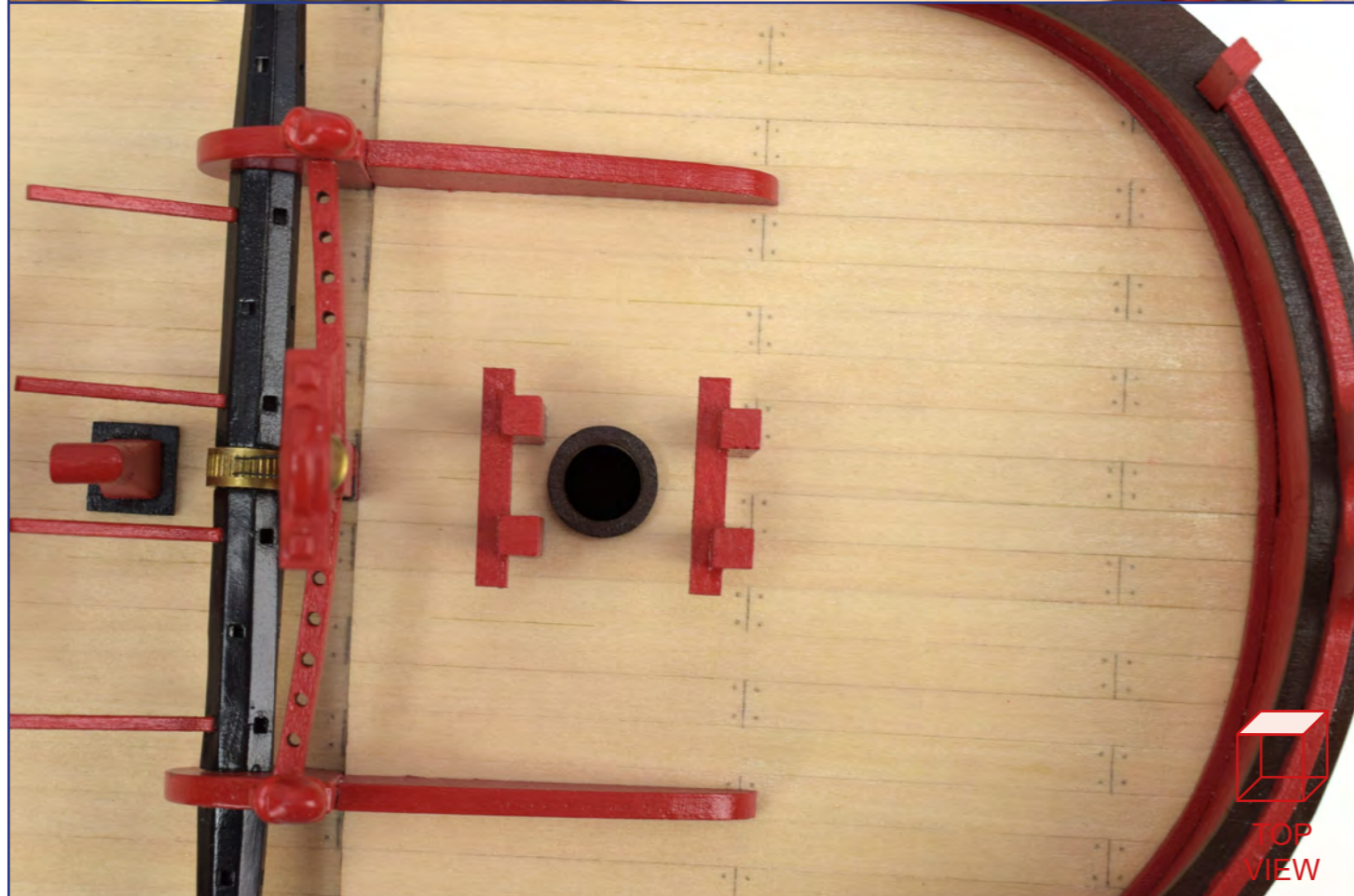
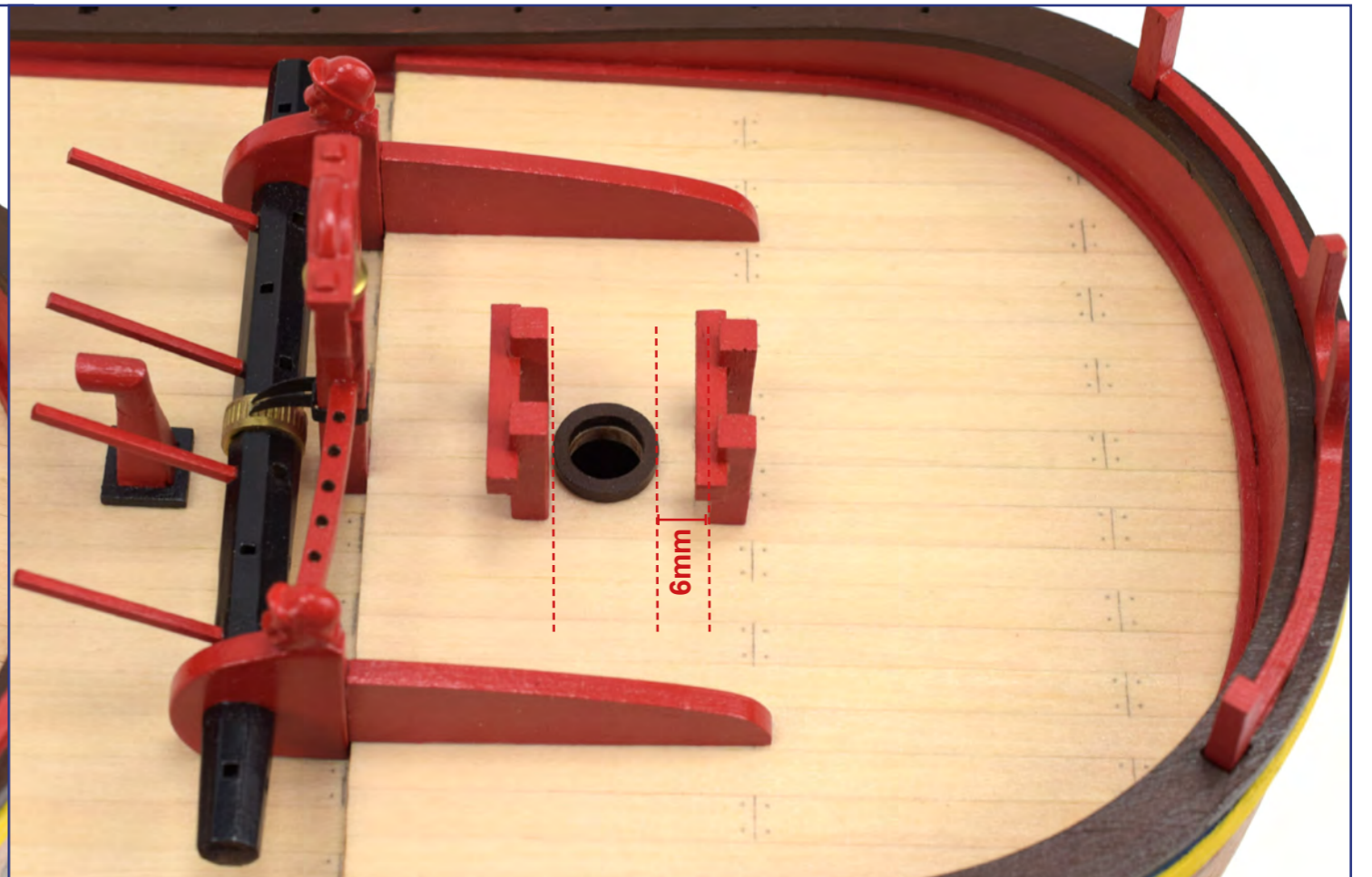
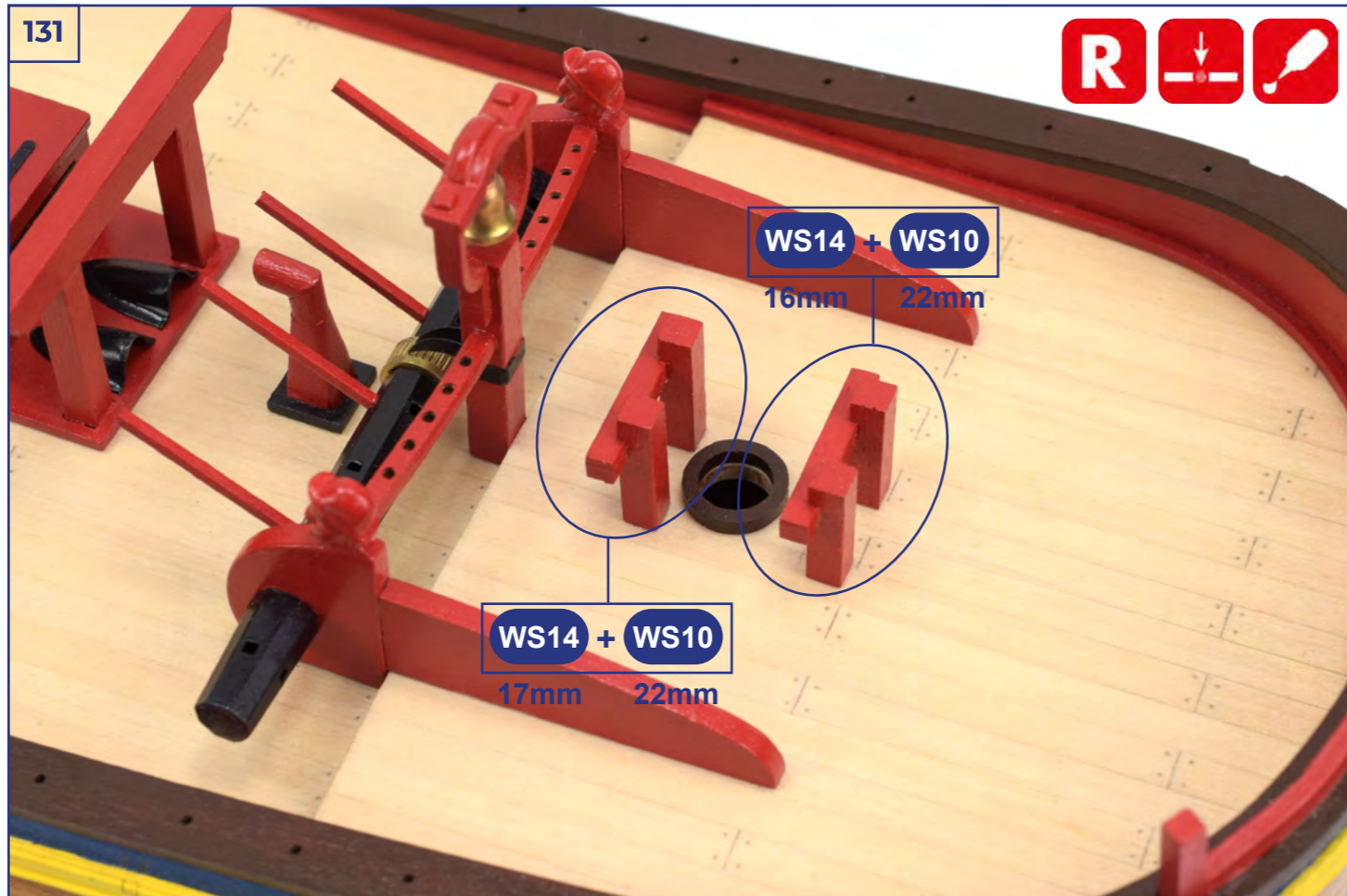

TOP VIEW



FRONT VIEW

132

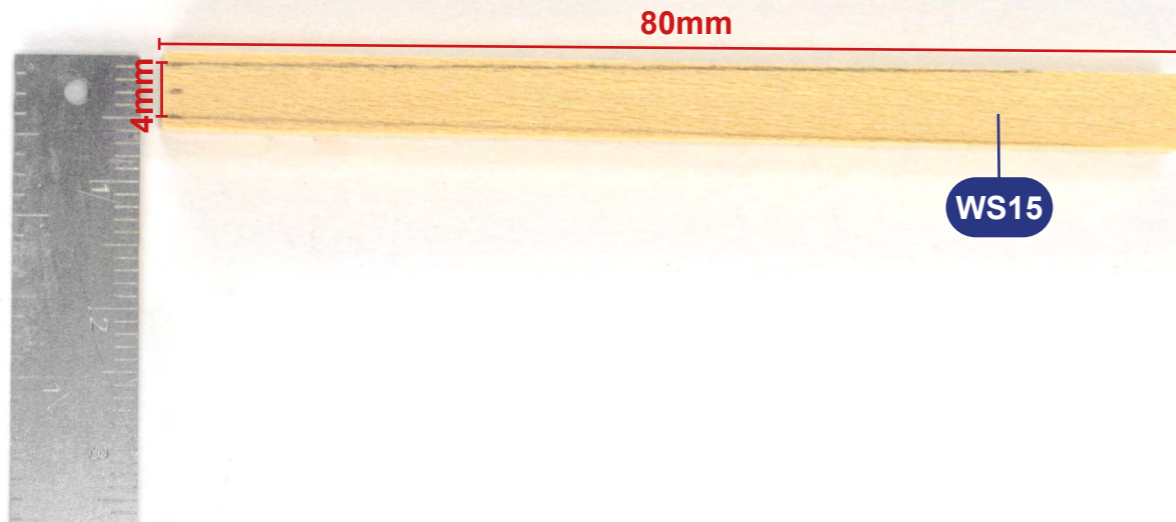

133

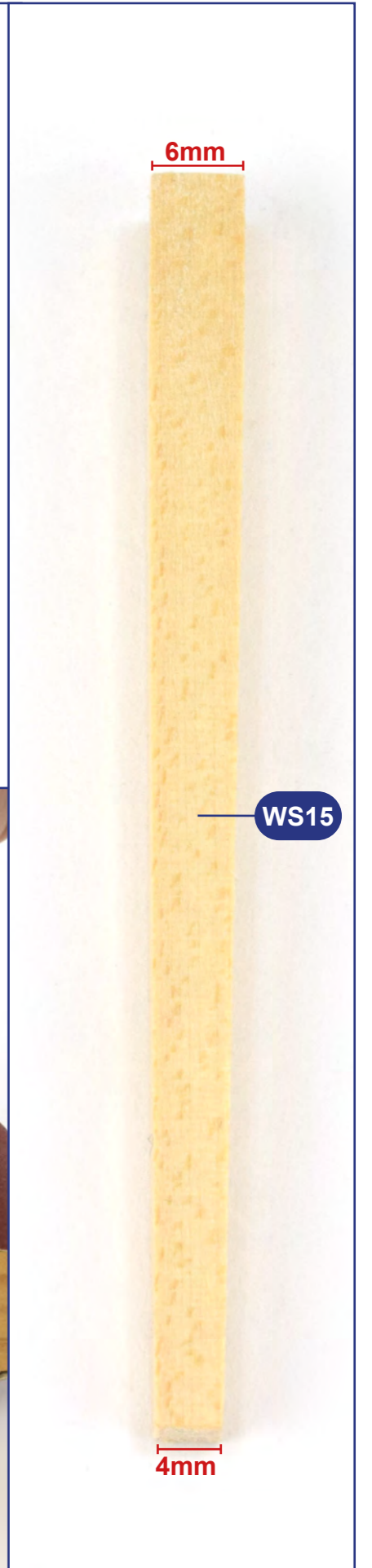
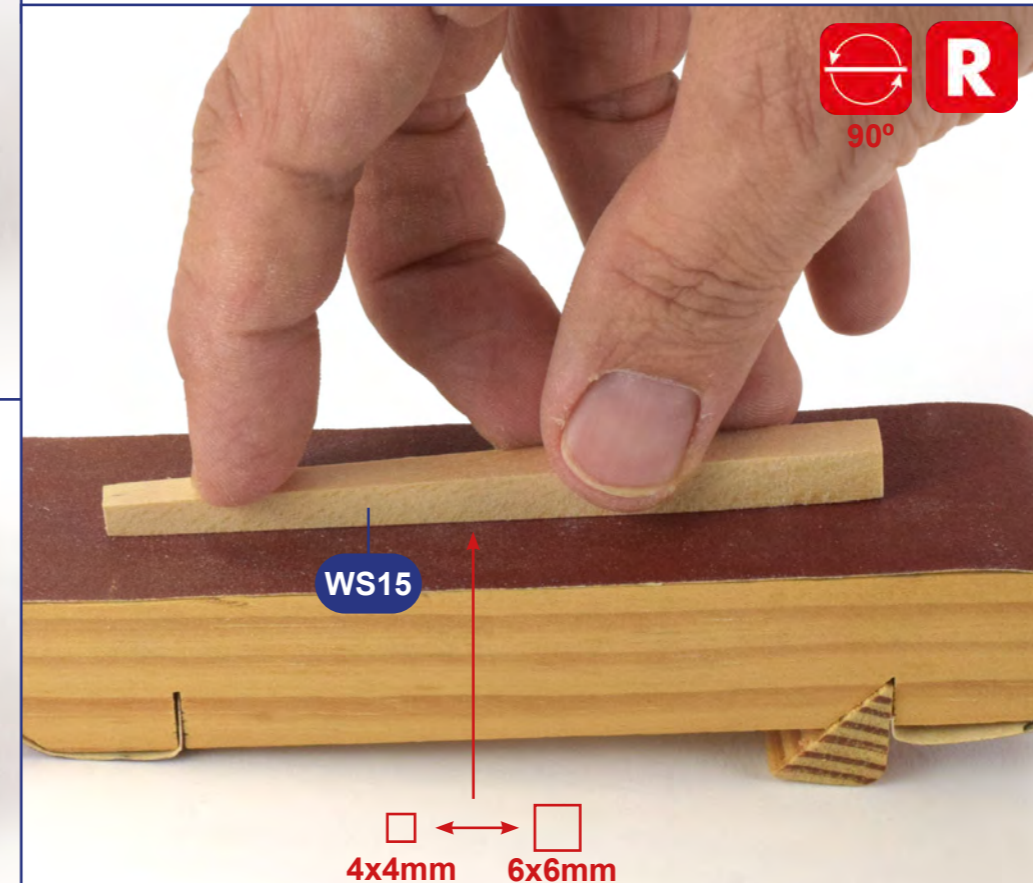
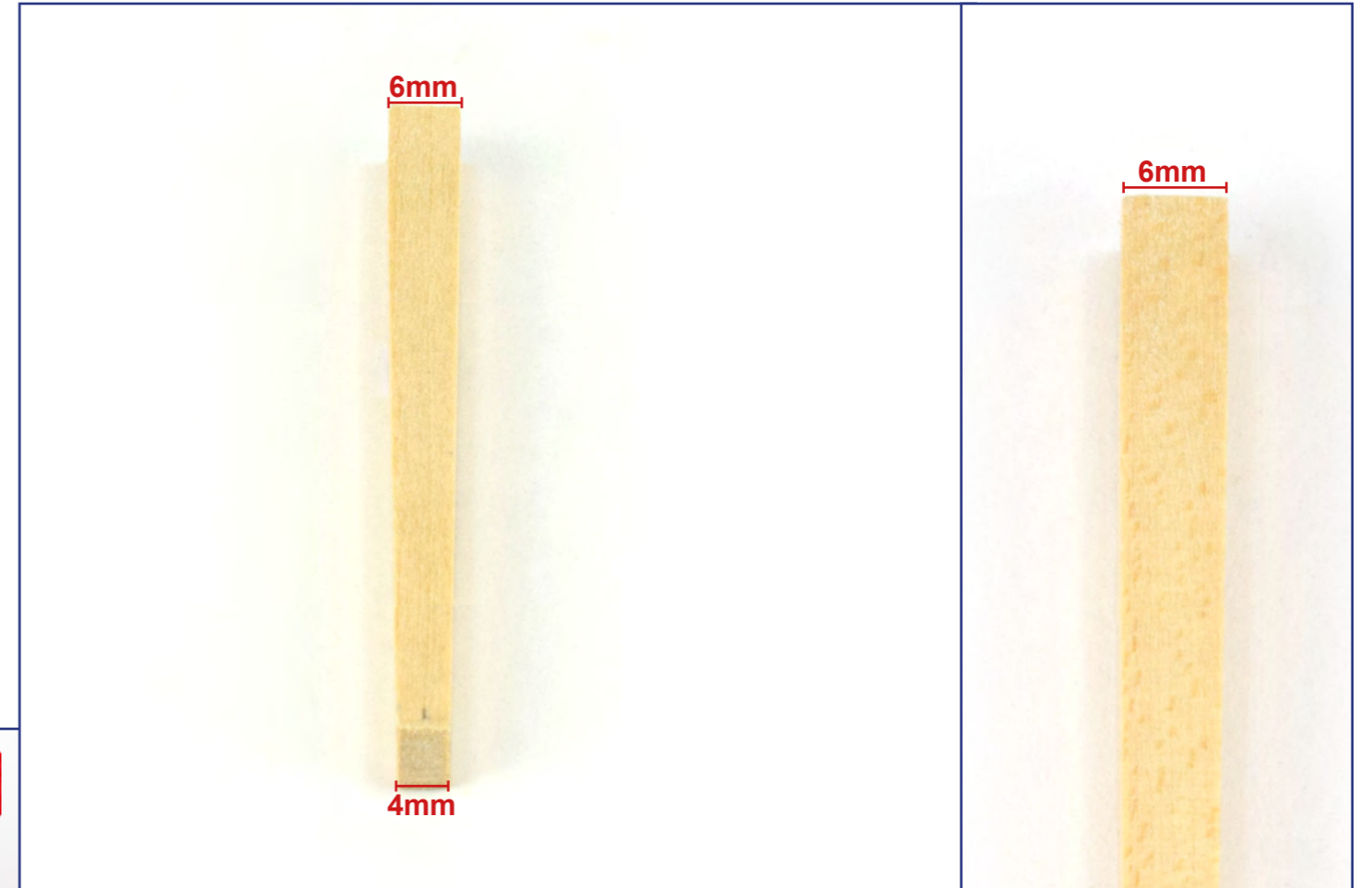

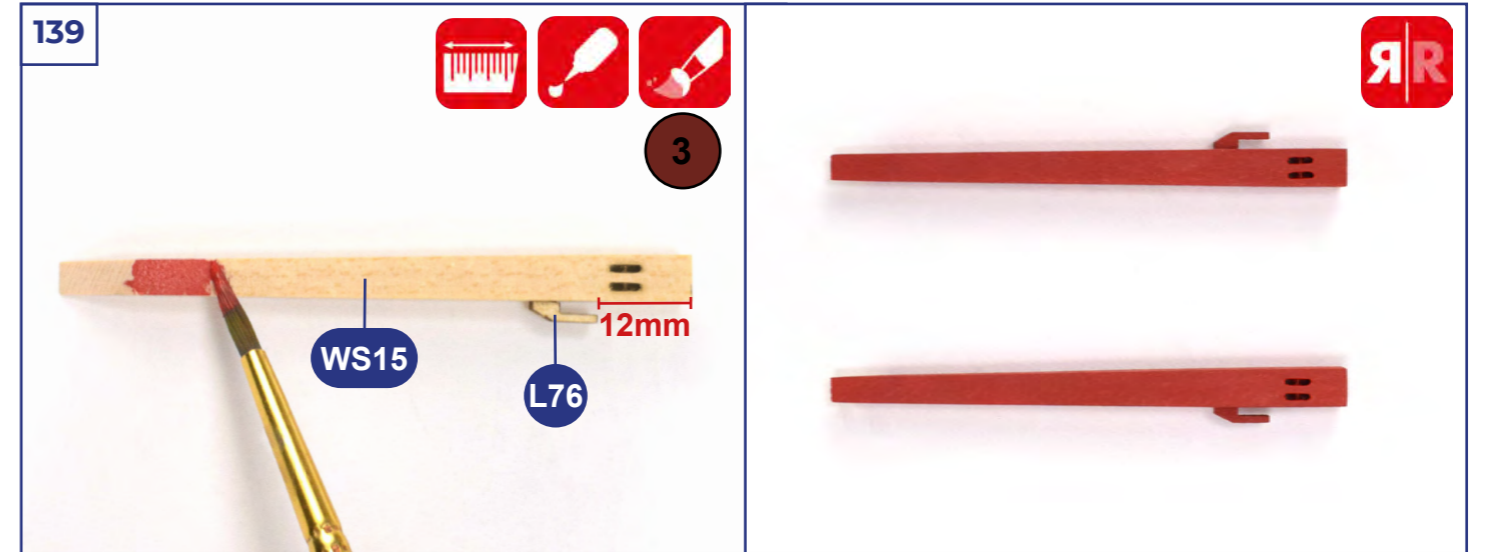
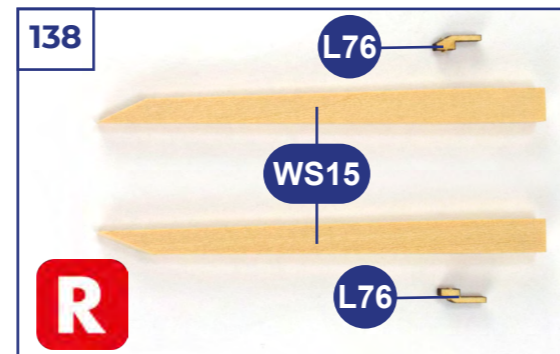
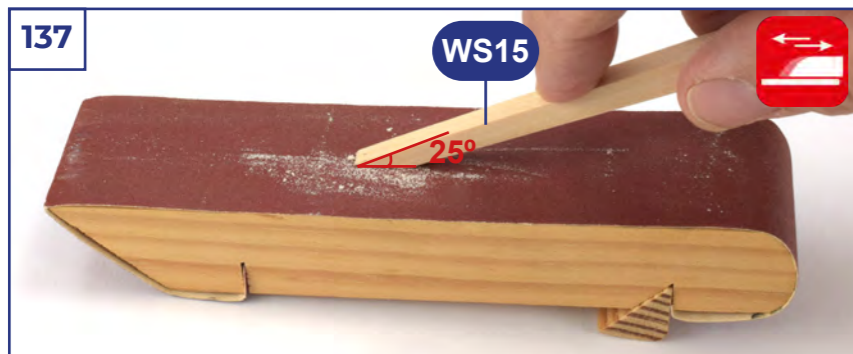
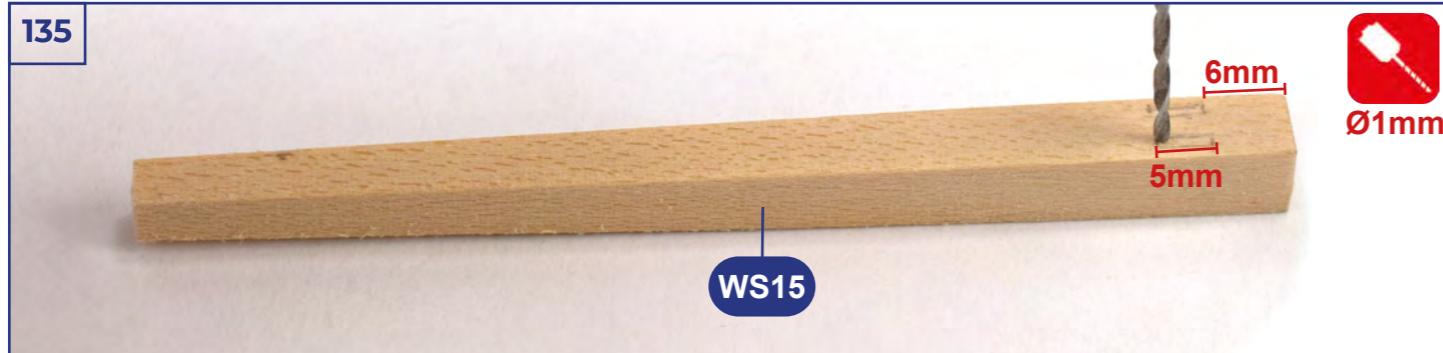
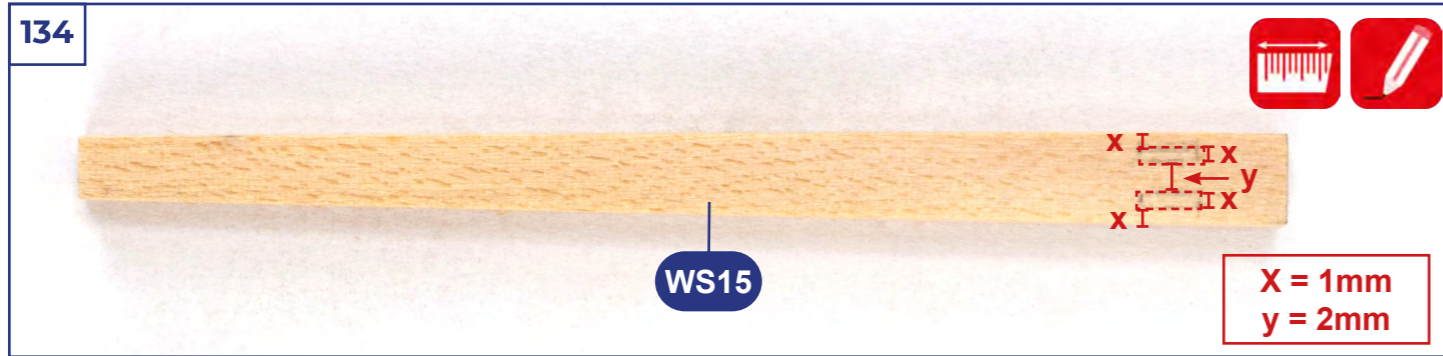



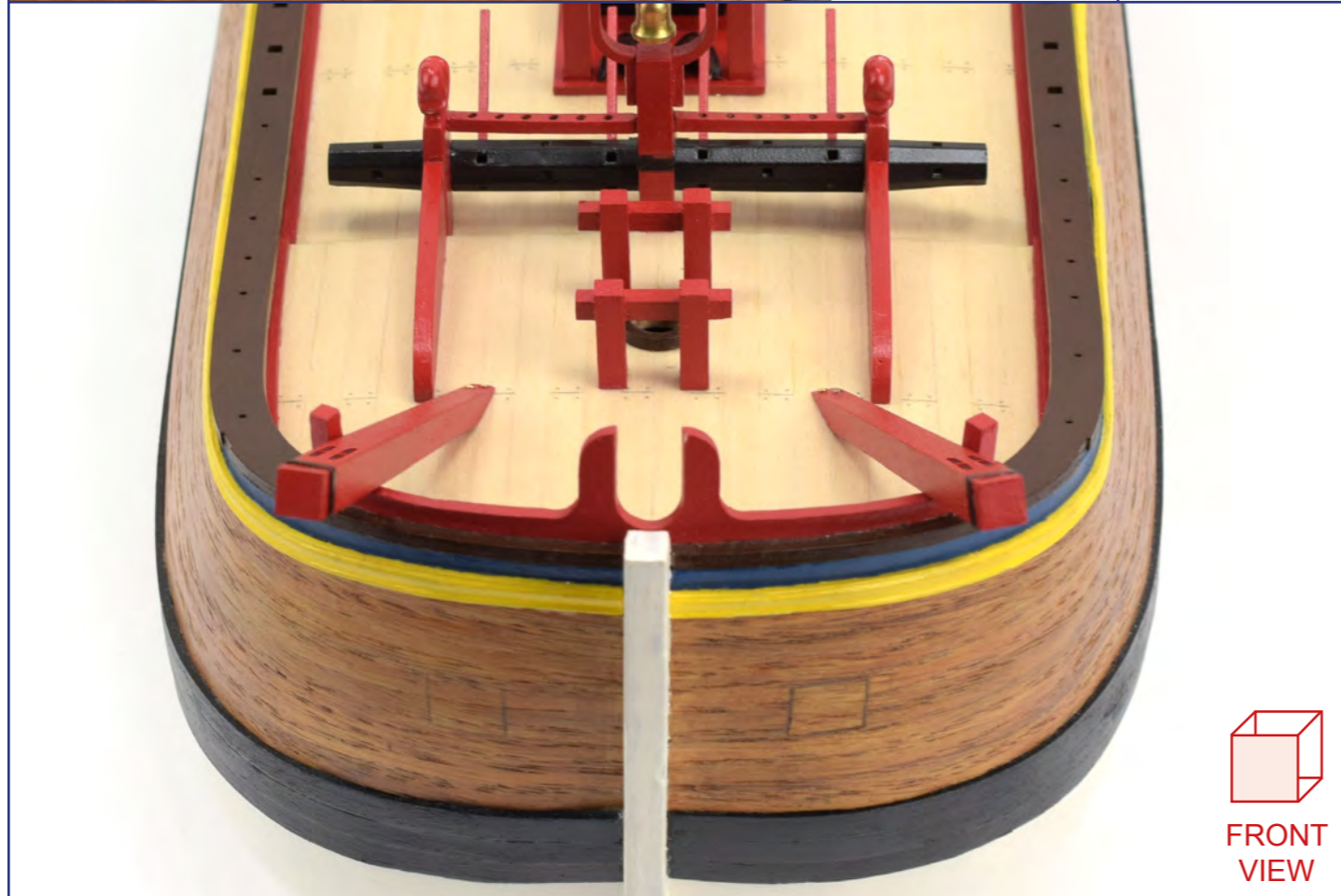
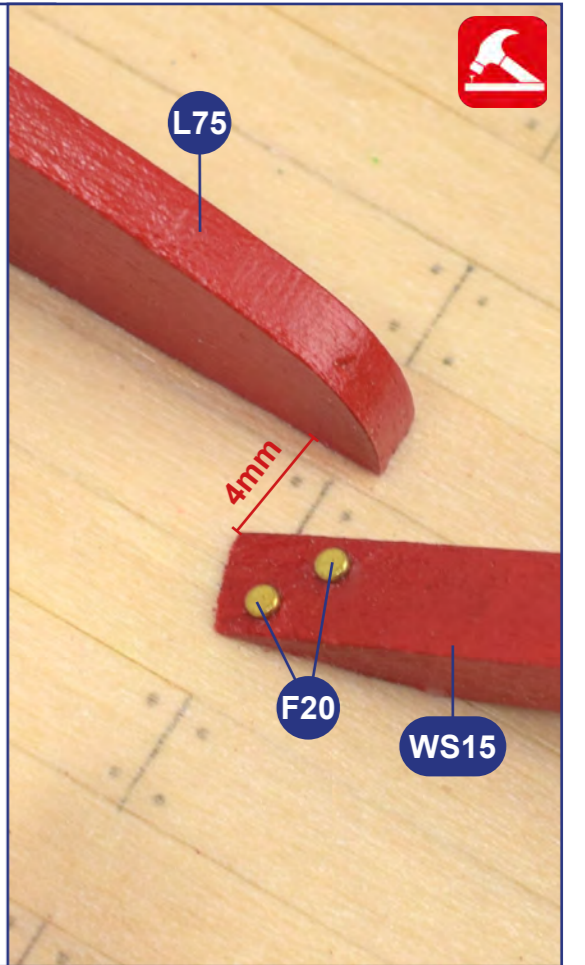
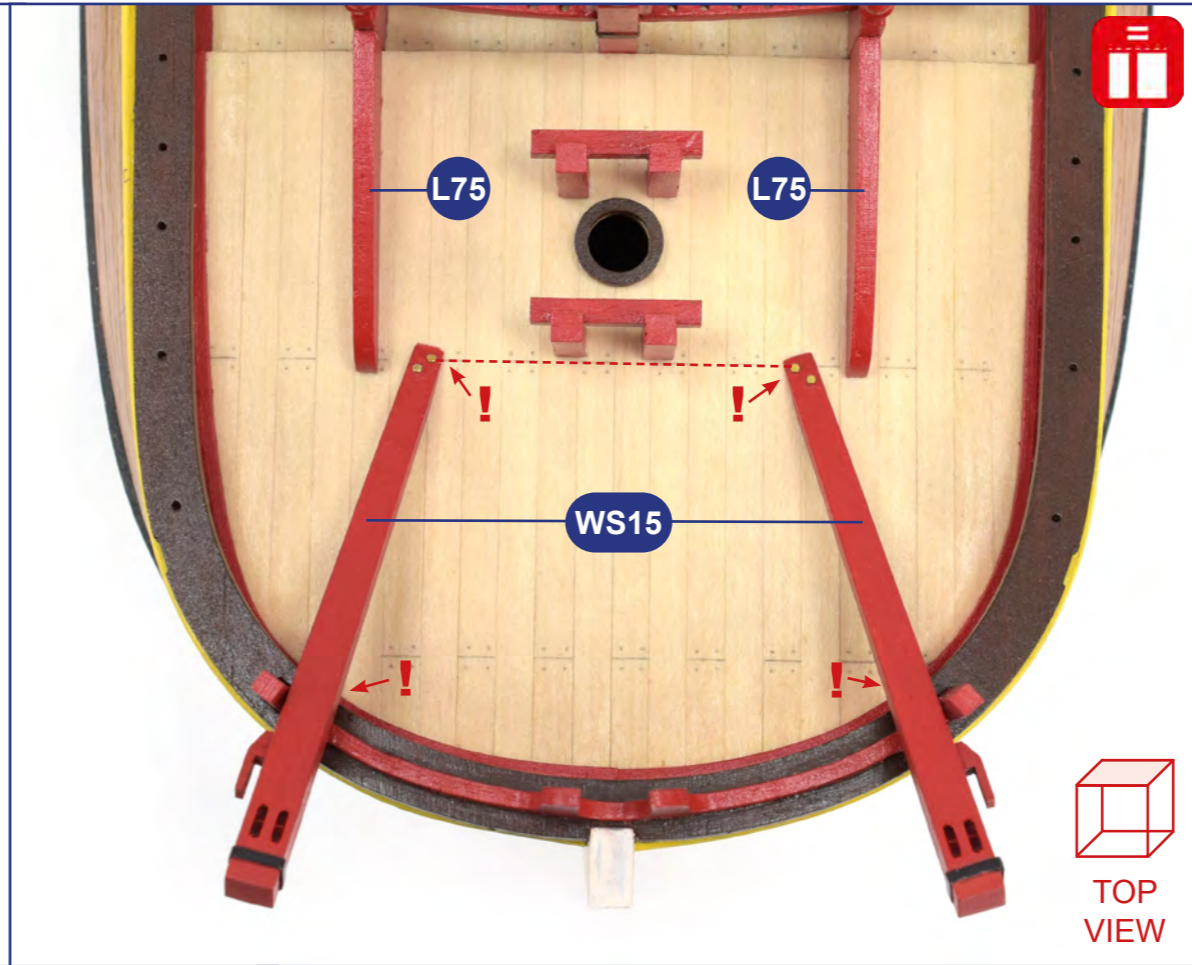

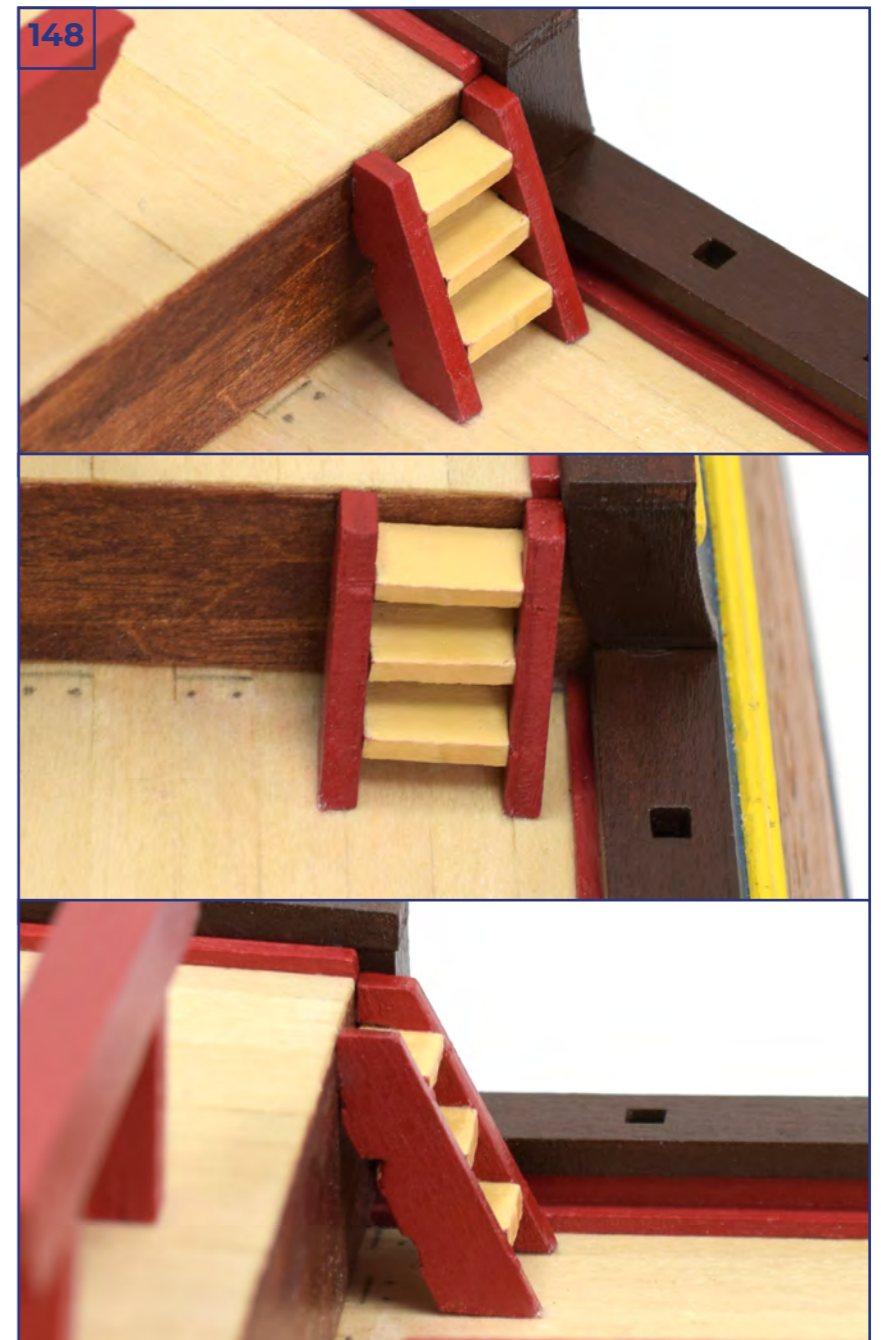
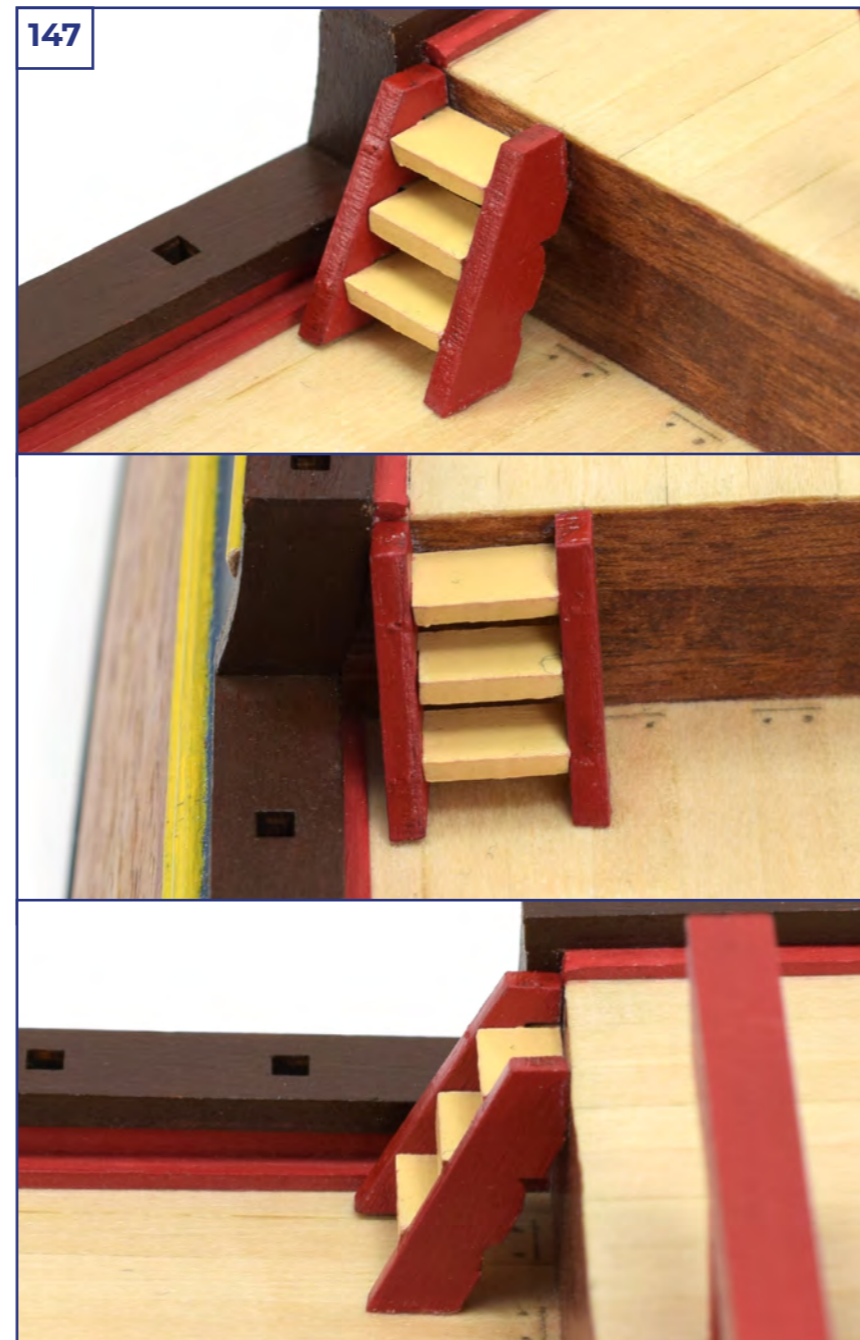
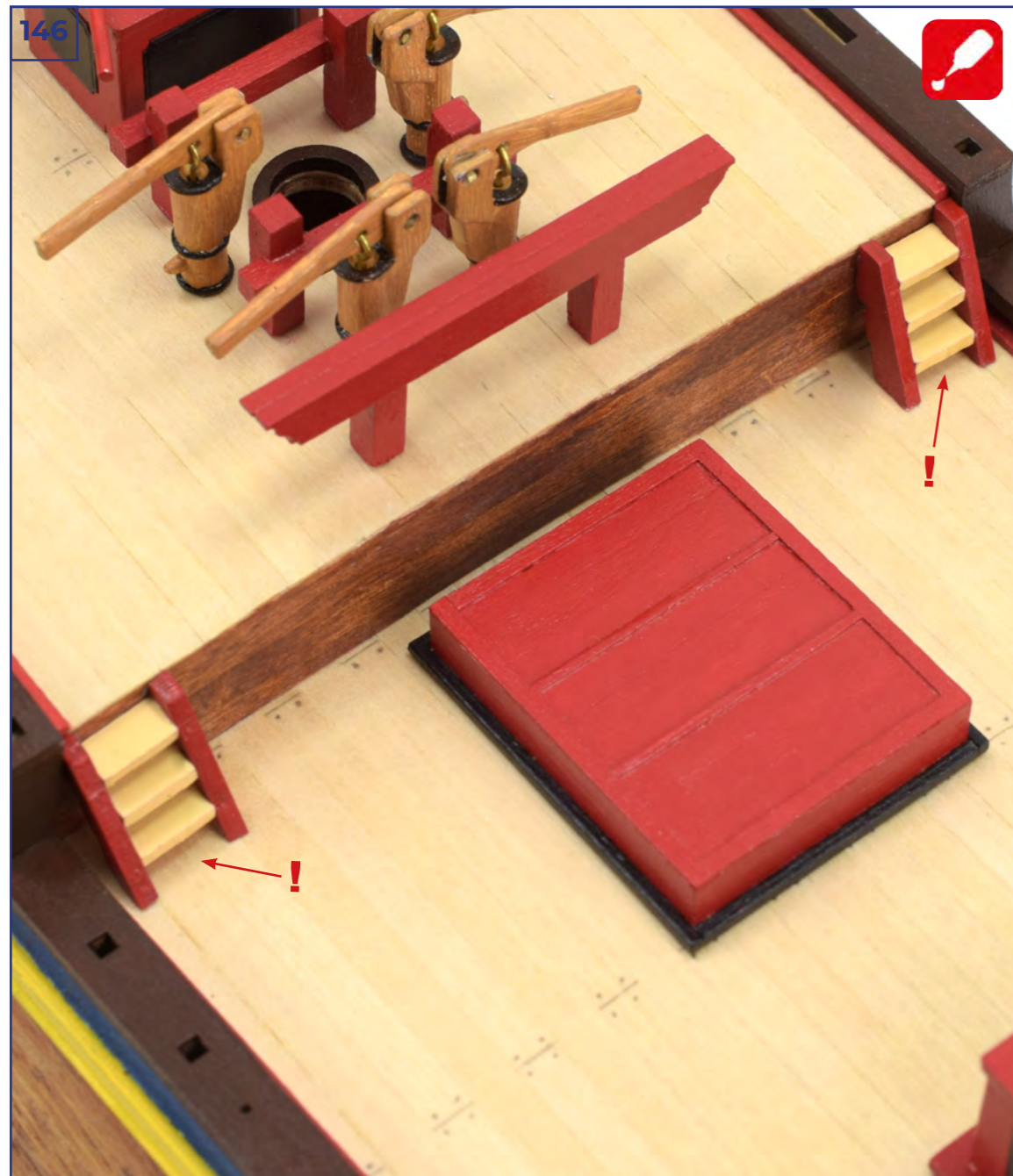
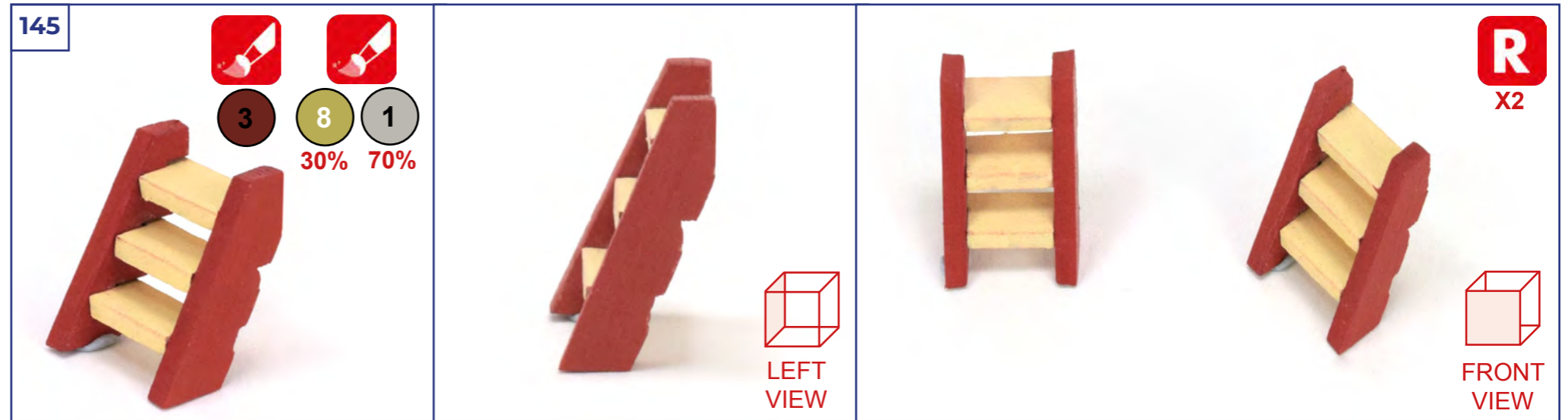
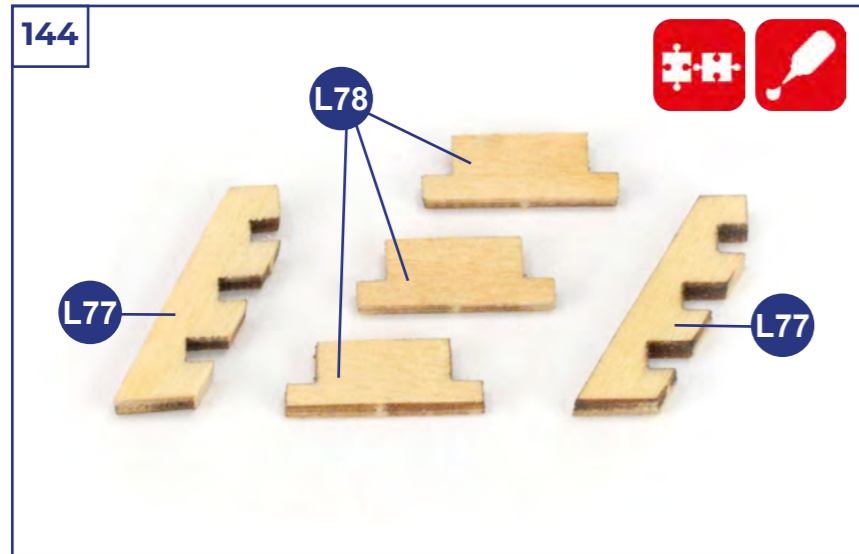
143





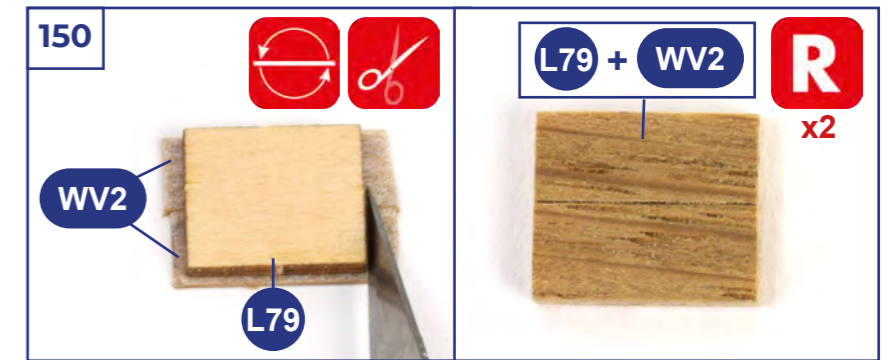
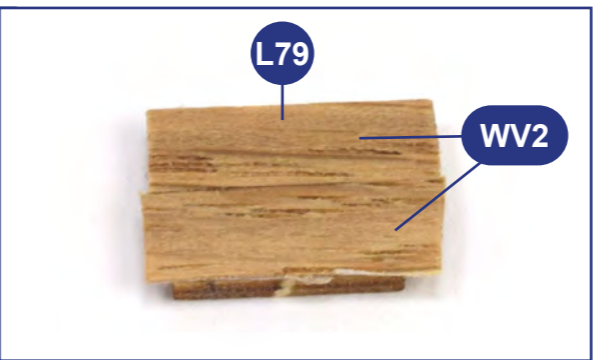
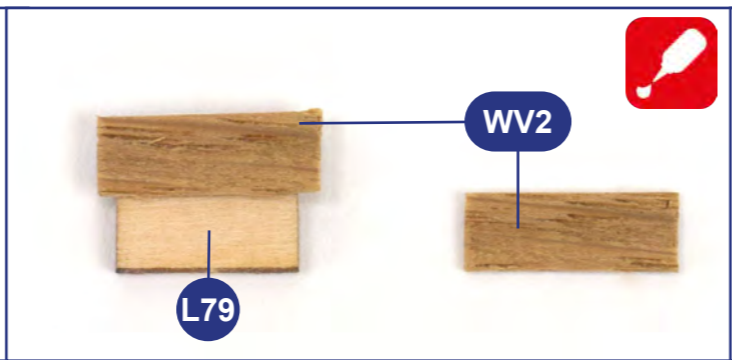
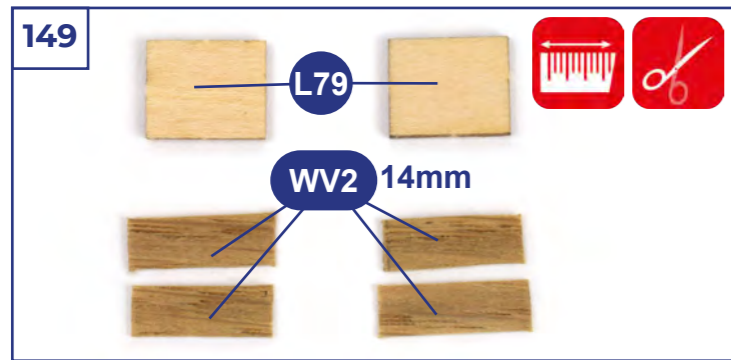

149  

150  

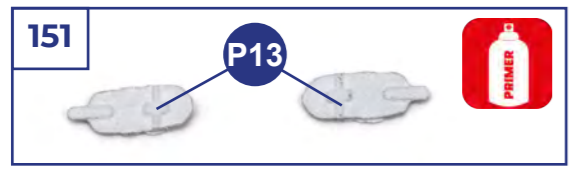

151 



152  6

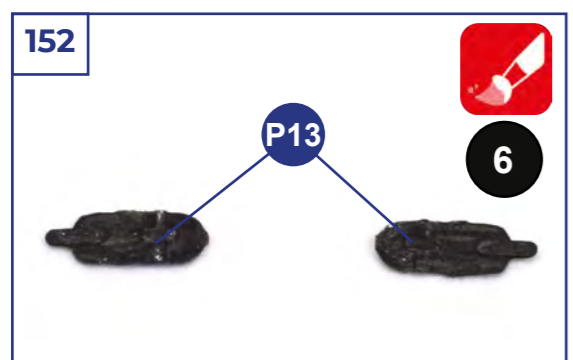

153 





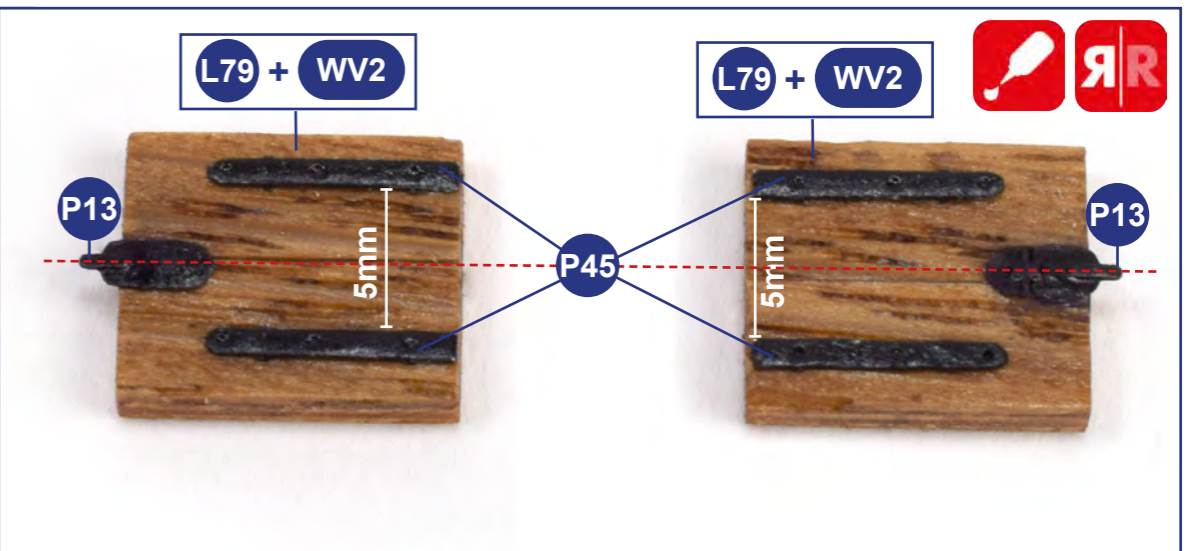

154 

57mm

L79 + WV2 + P13 + P45

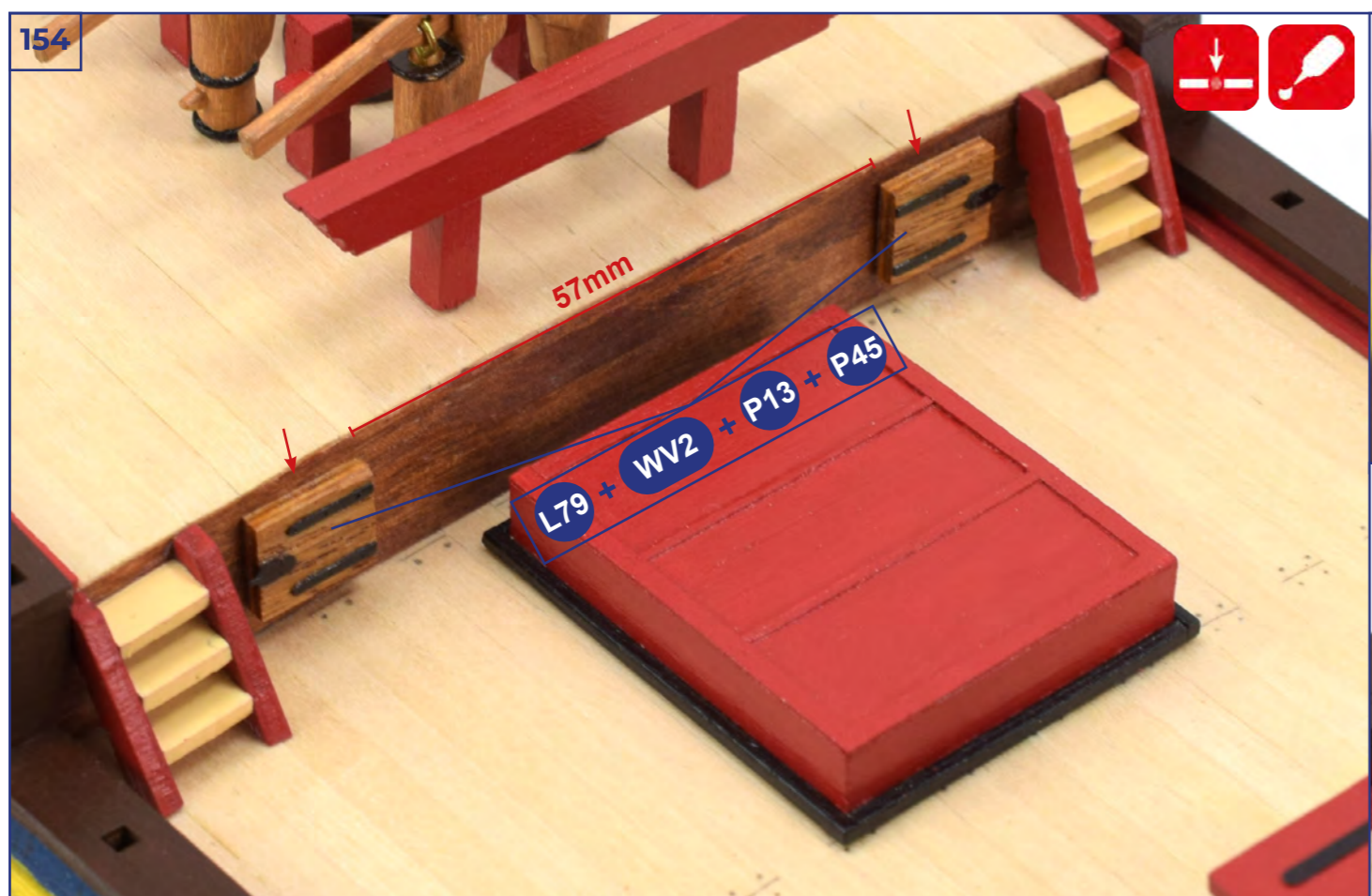

A FRONT VIEW B

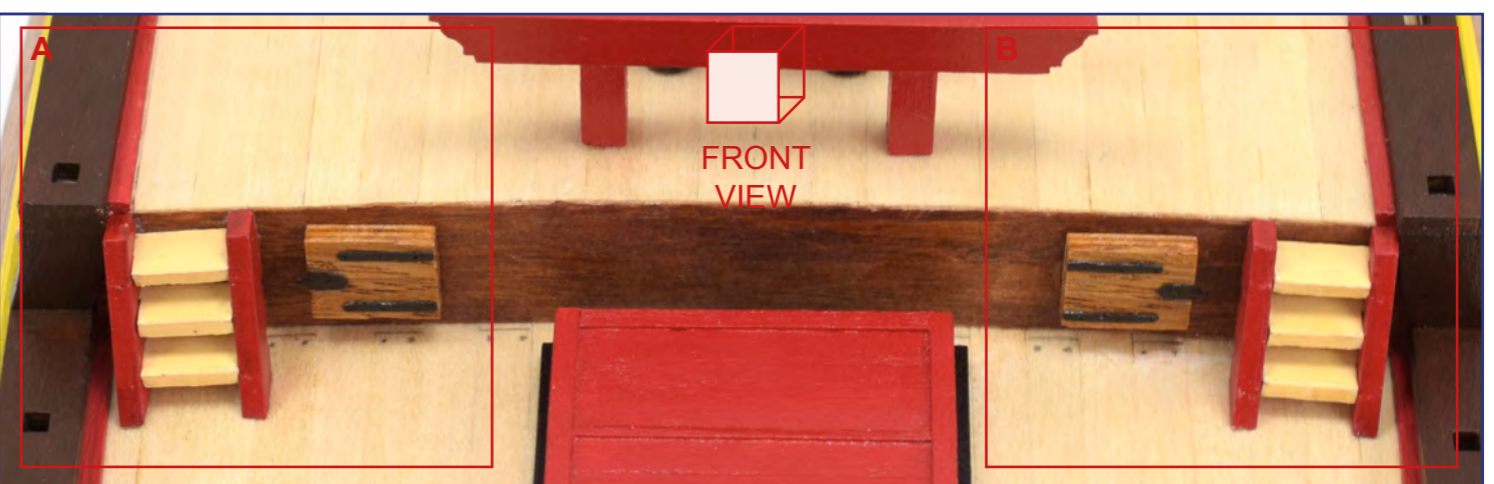

A B

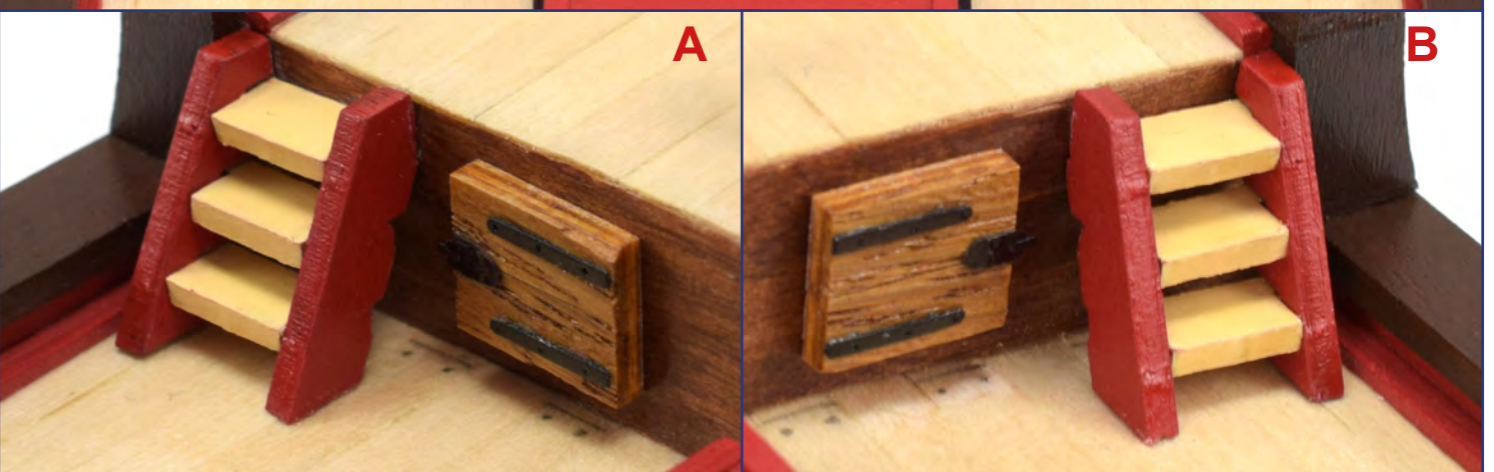

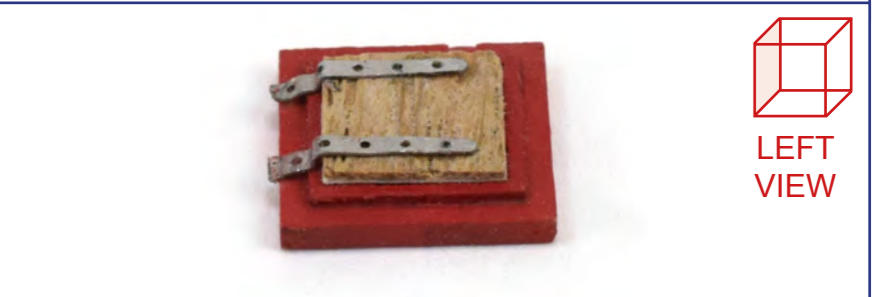
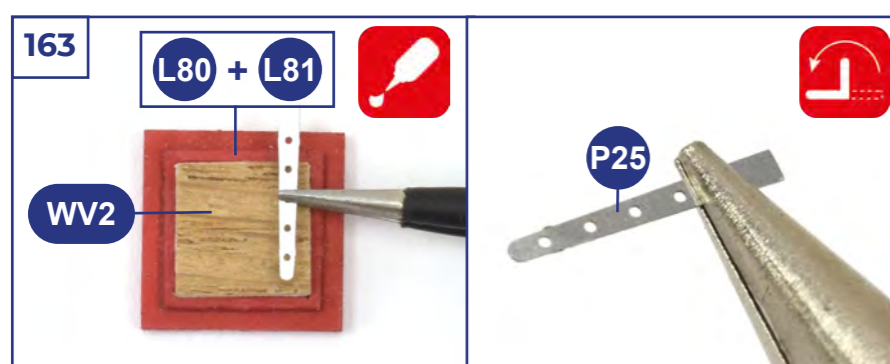
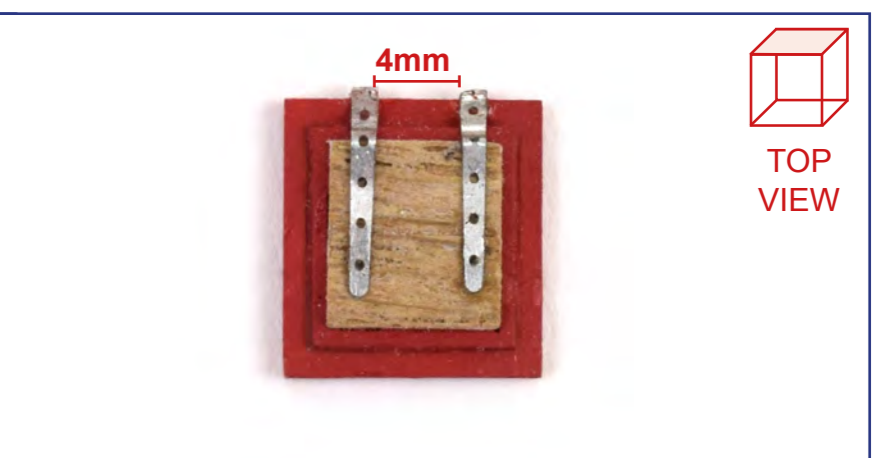
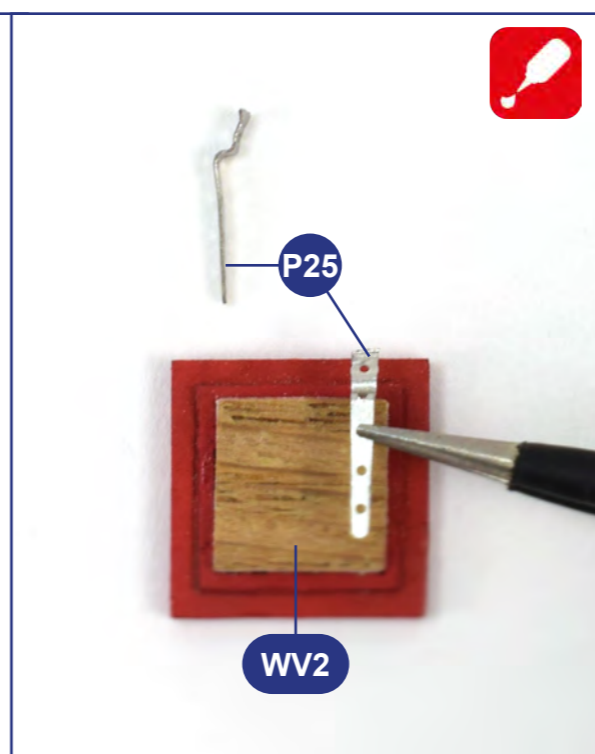
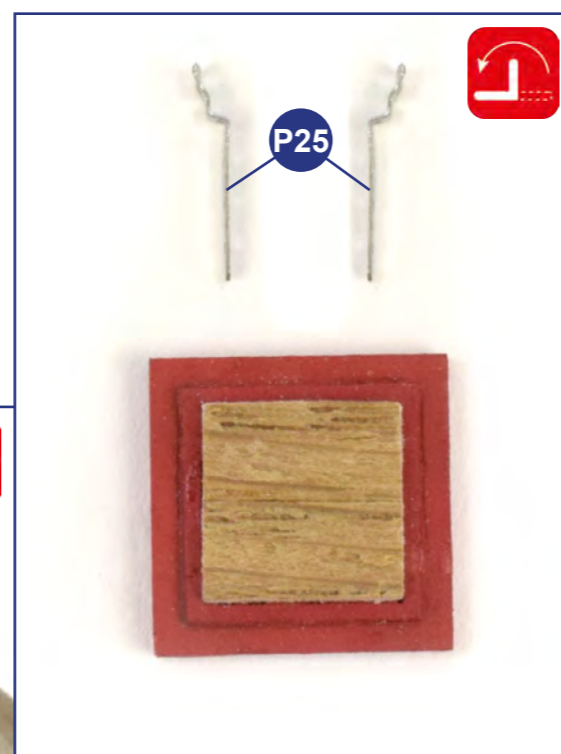
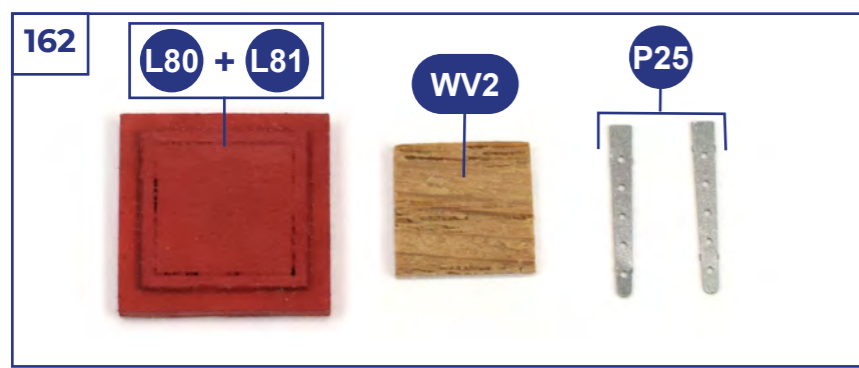
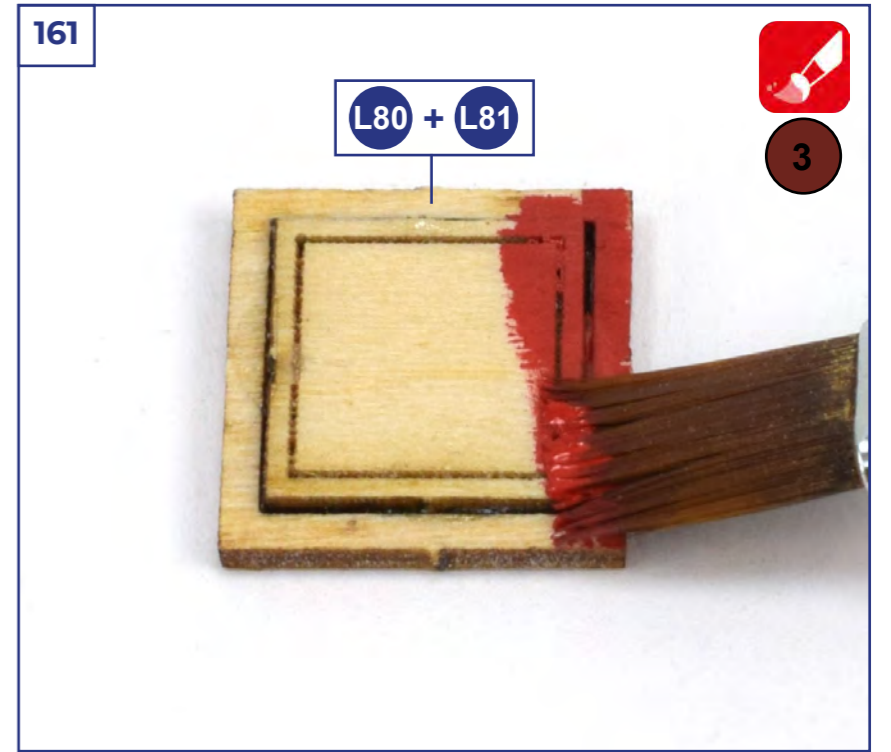
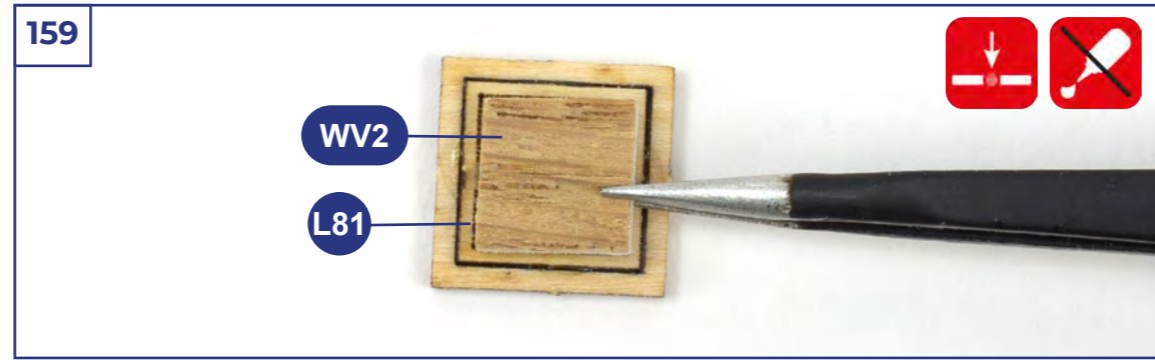
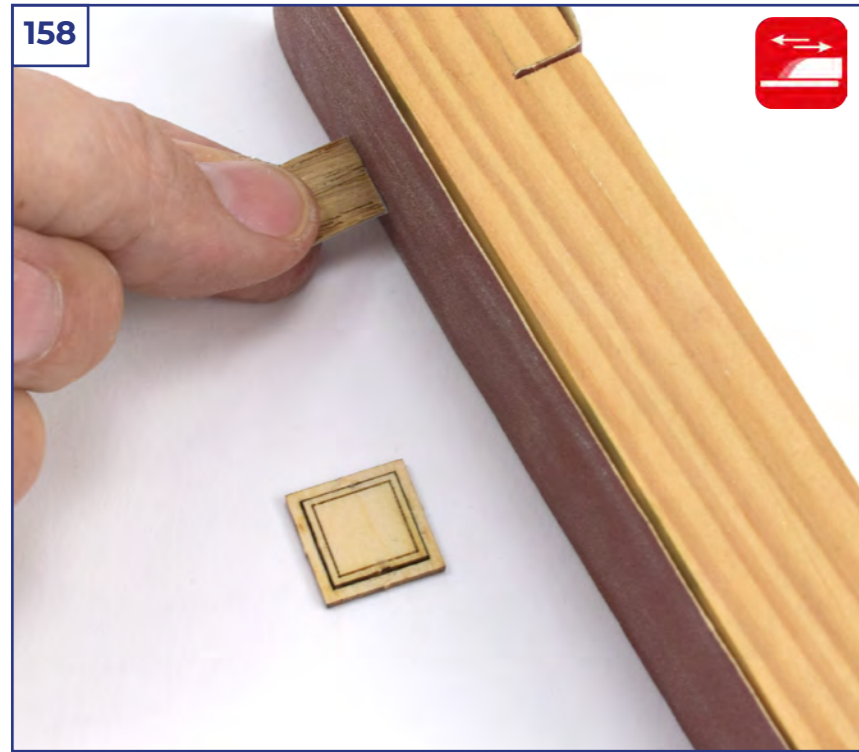
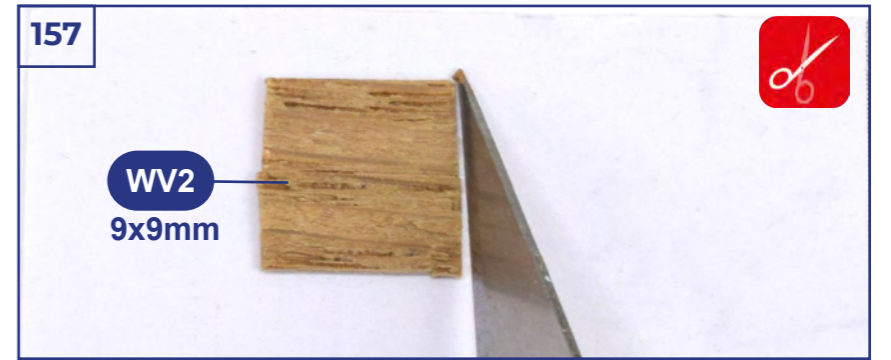
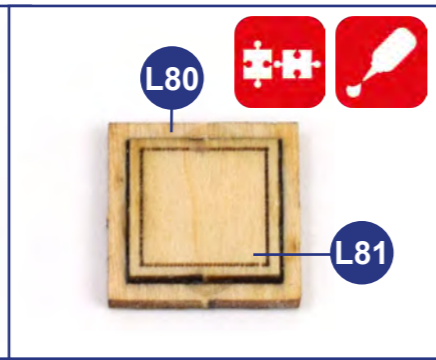
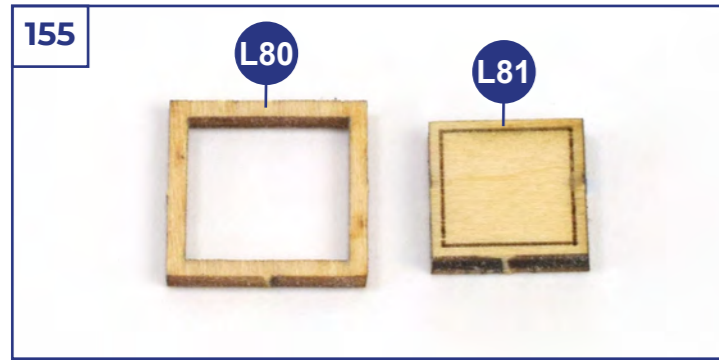

164

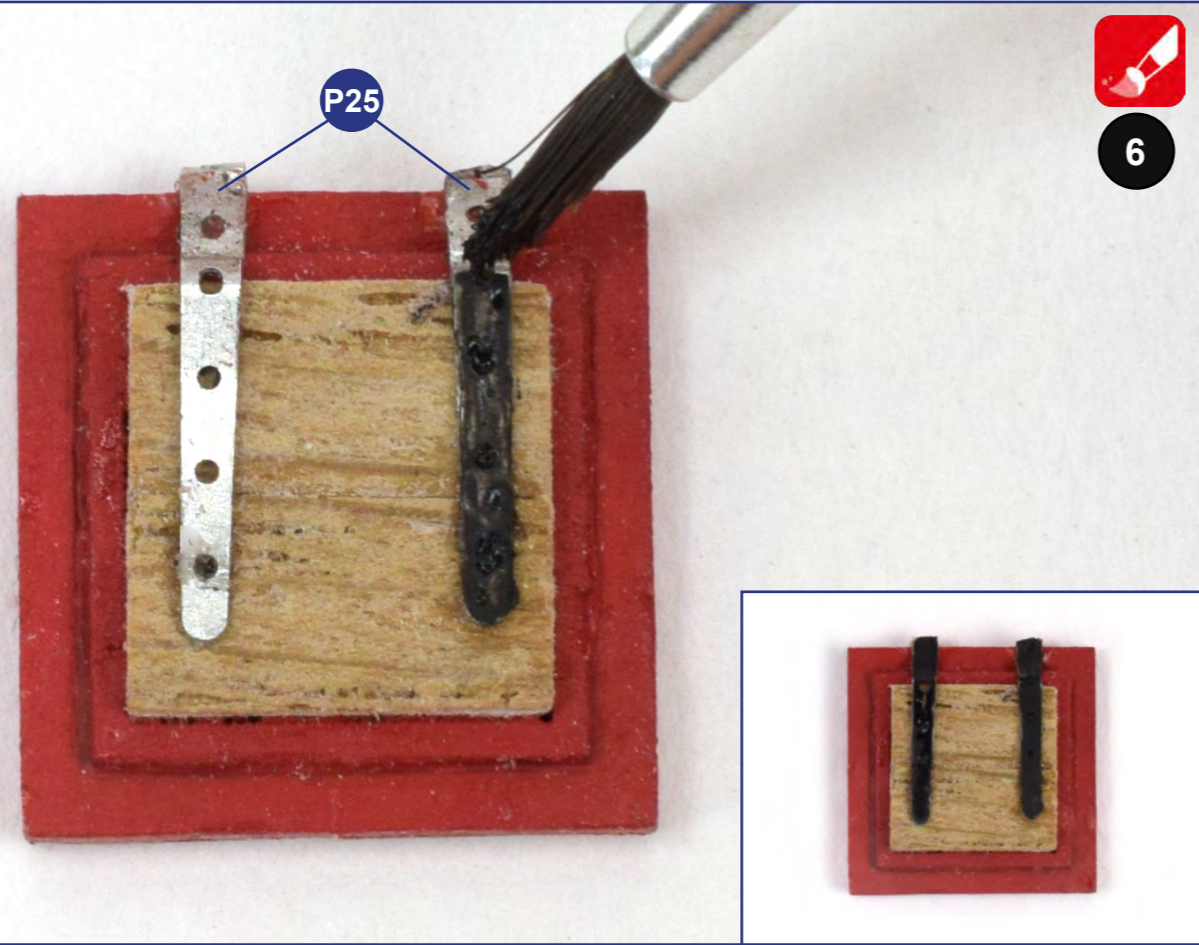

165

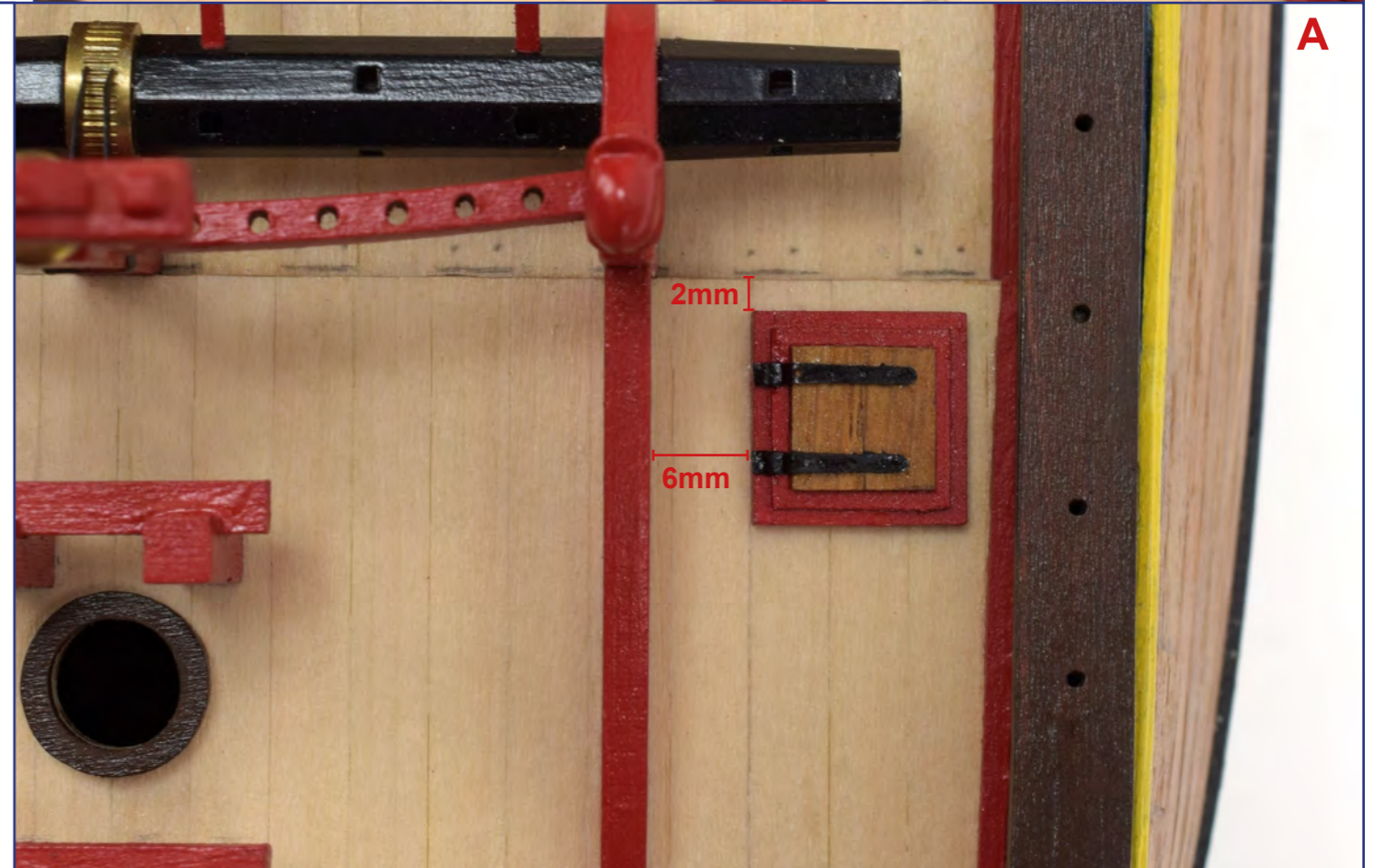
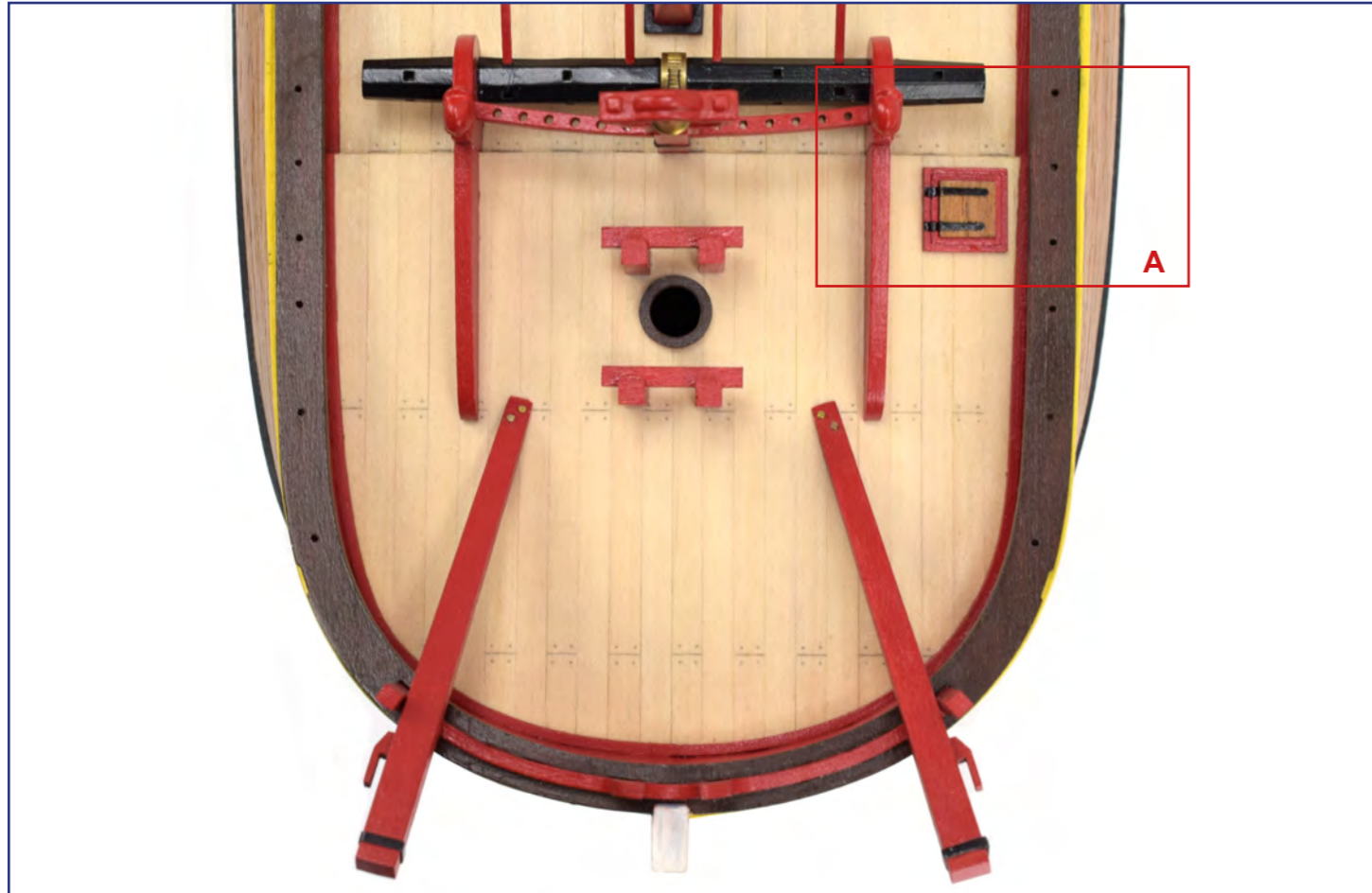

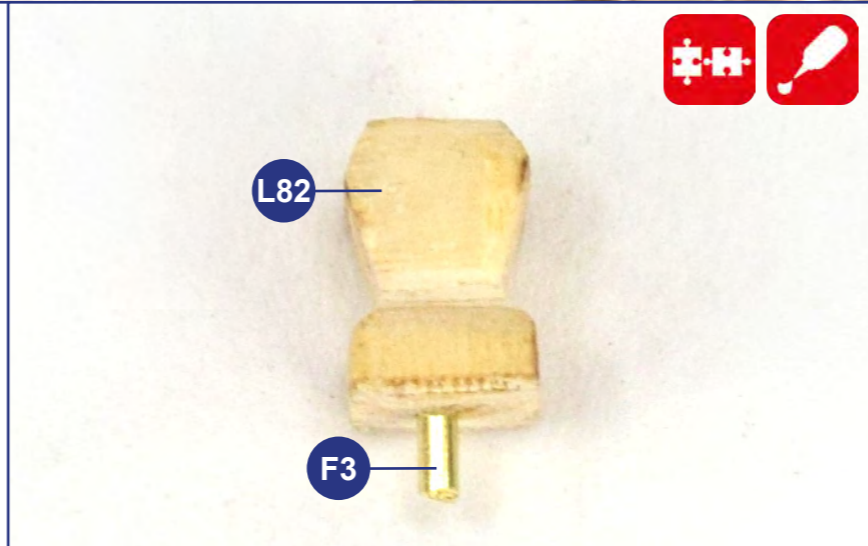
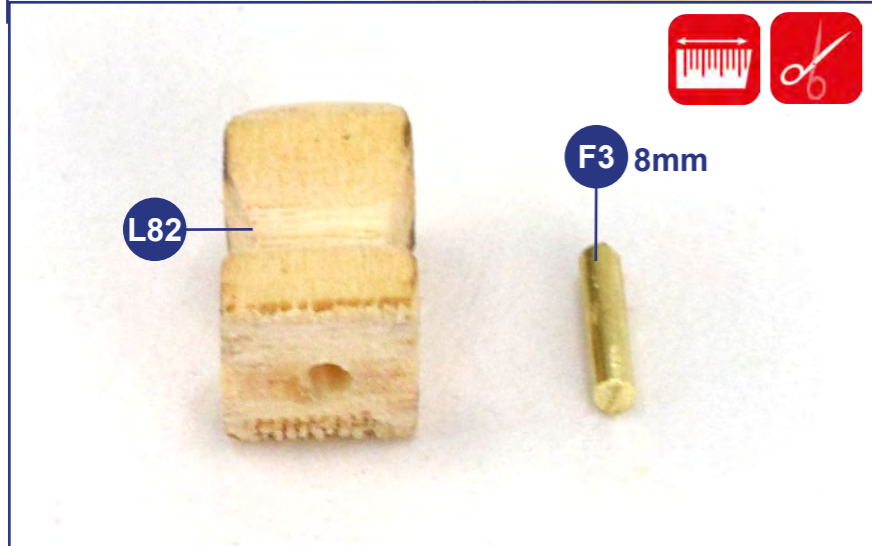
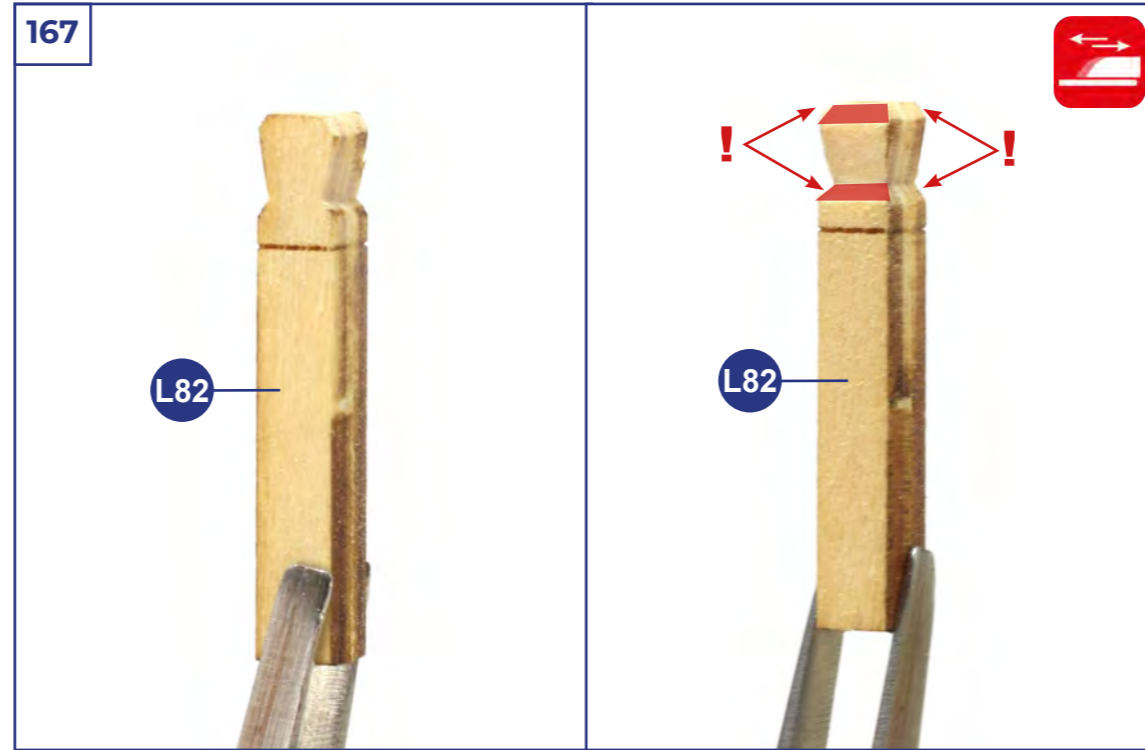
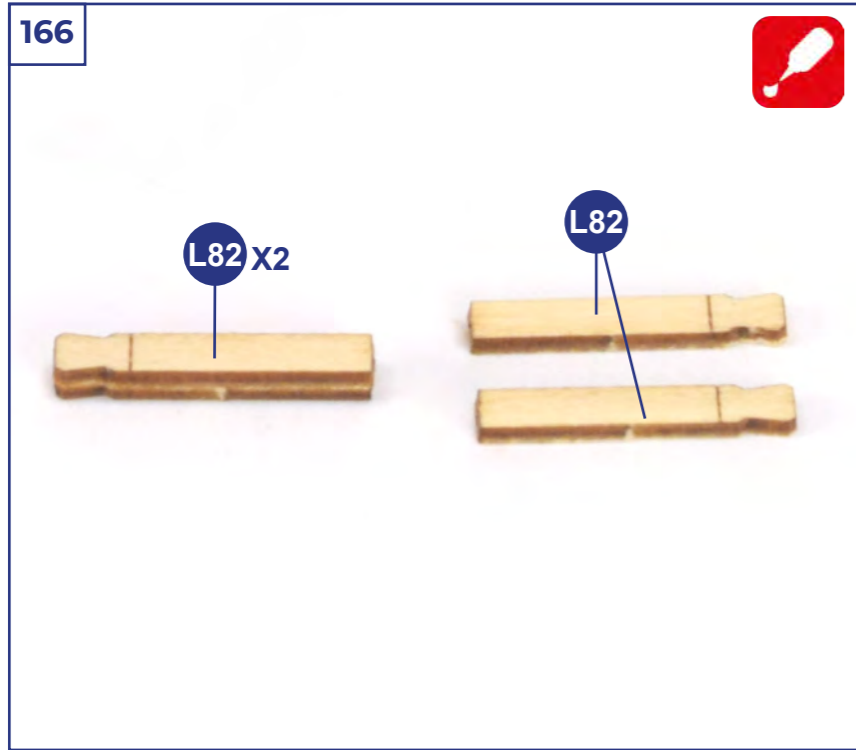

171

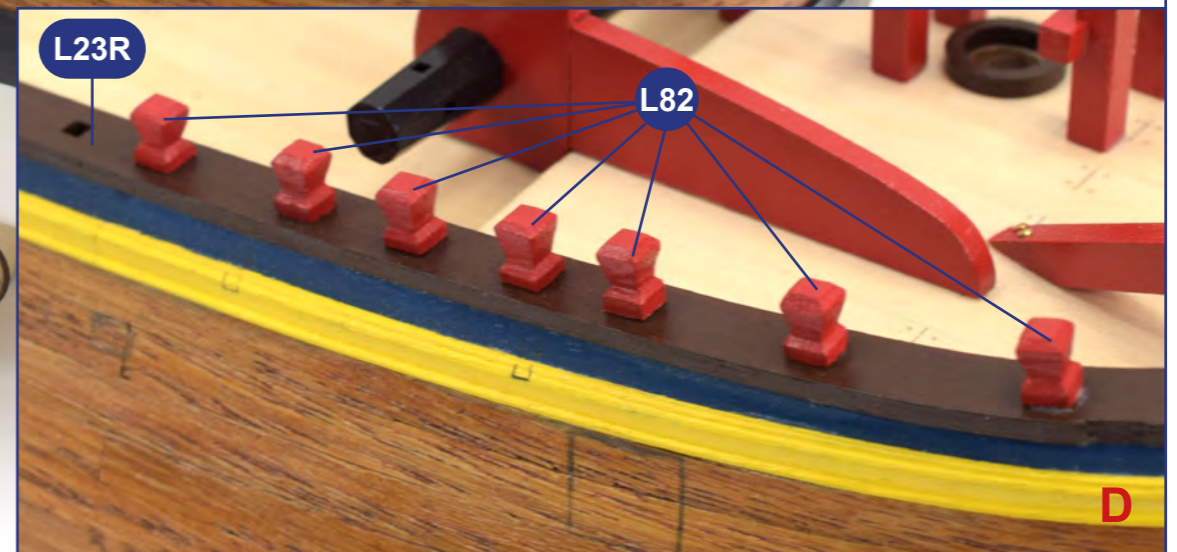
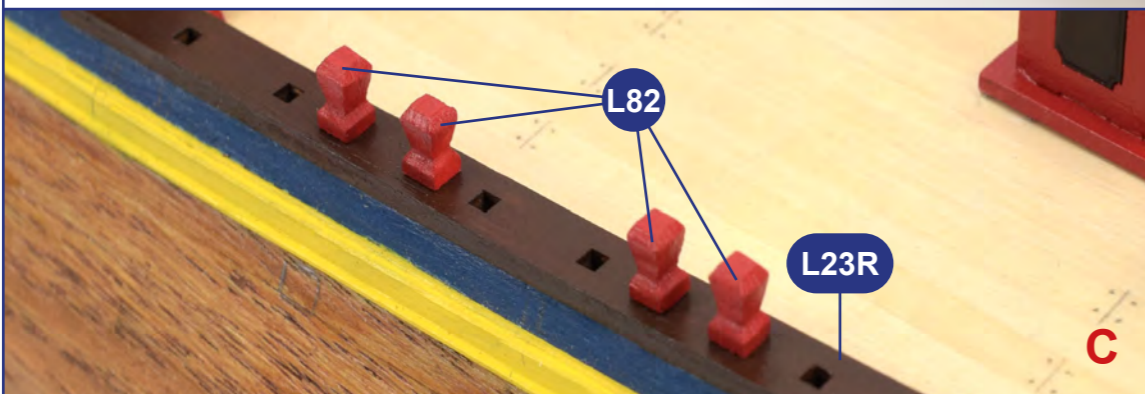
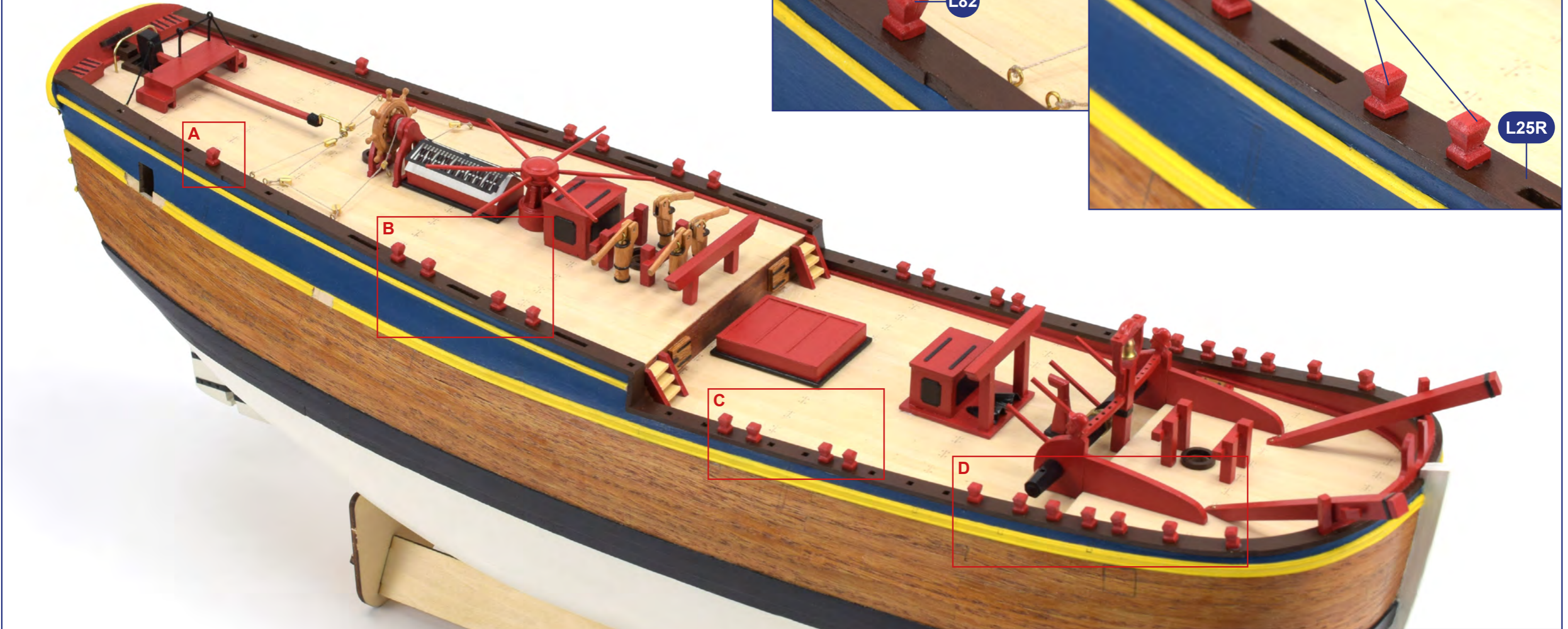
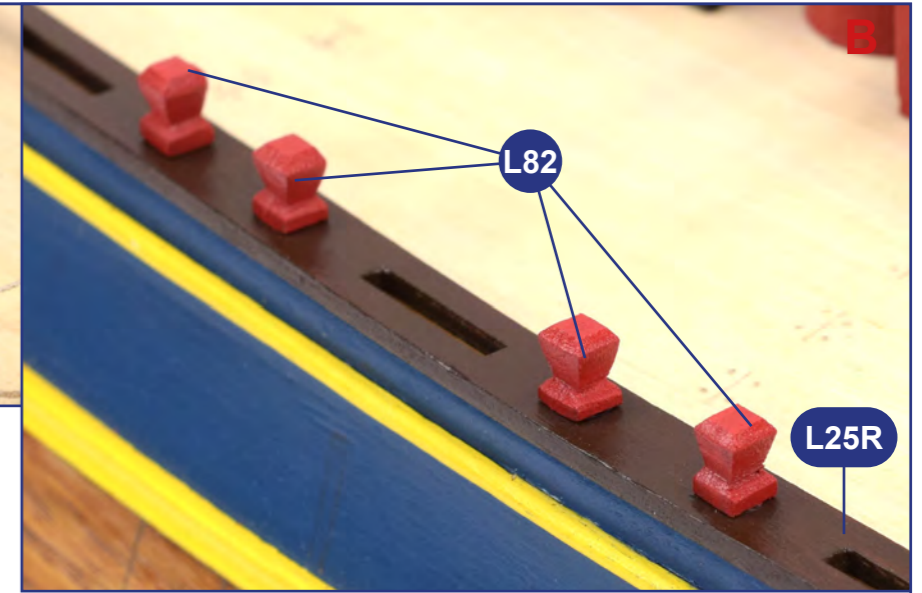
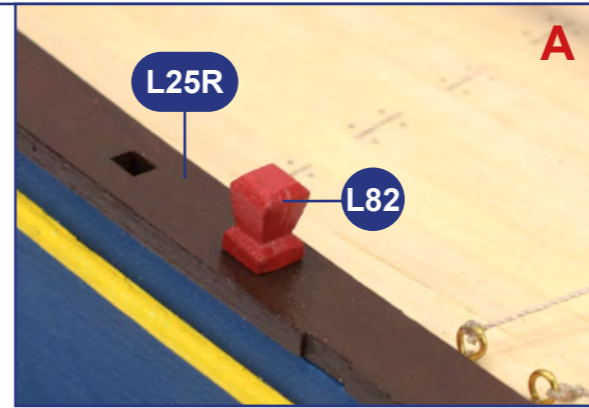

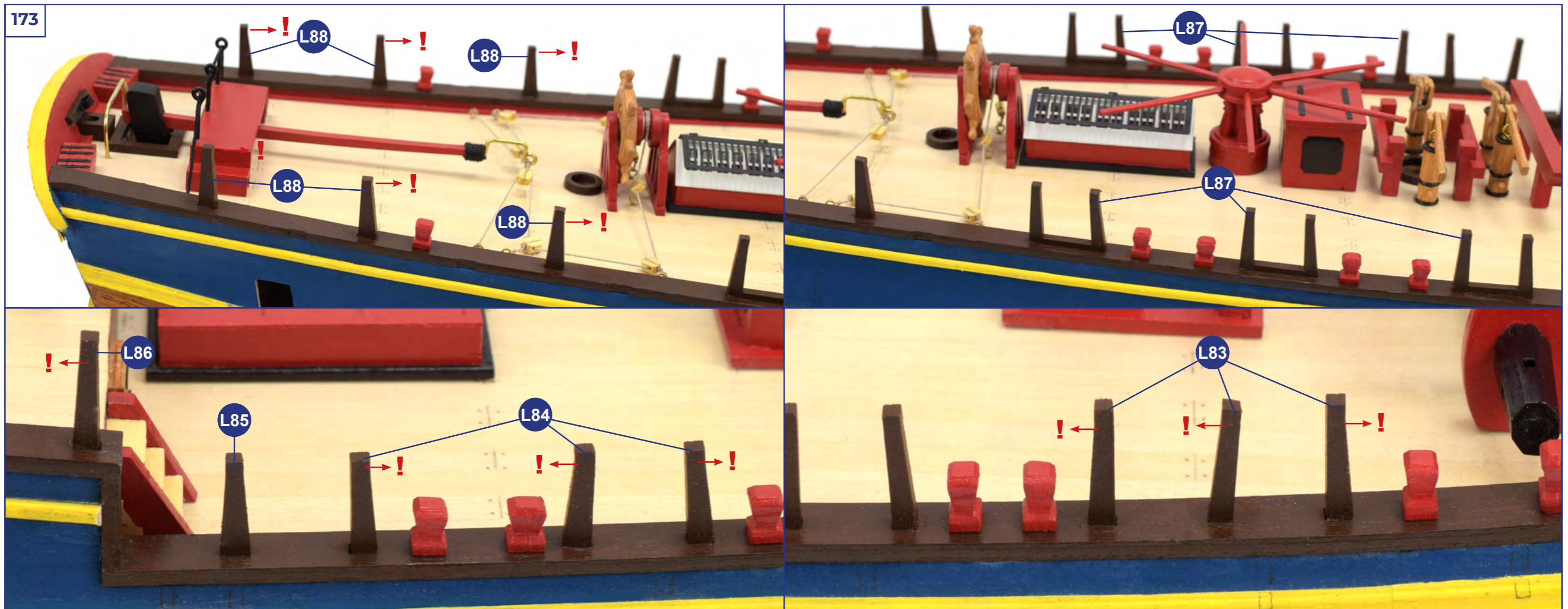
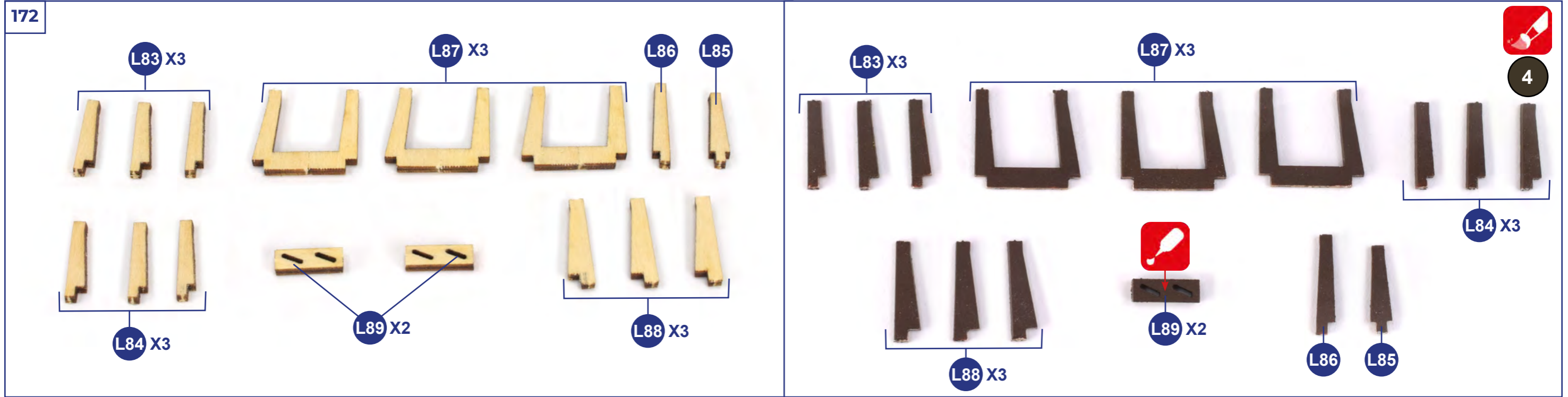

174

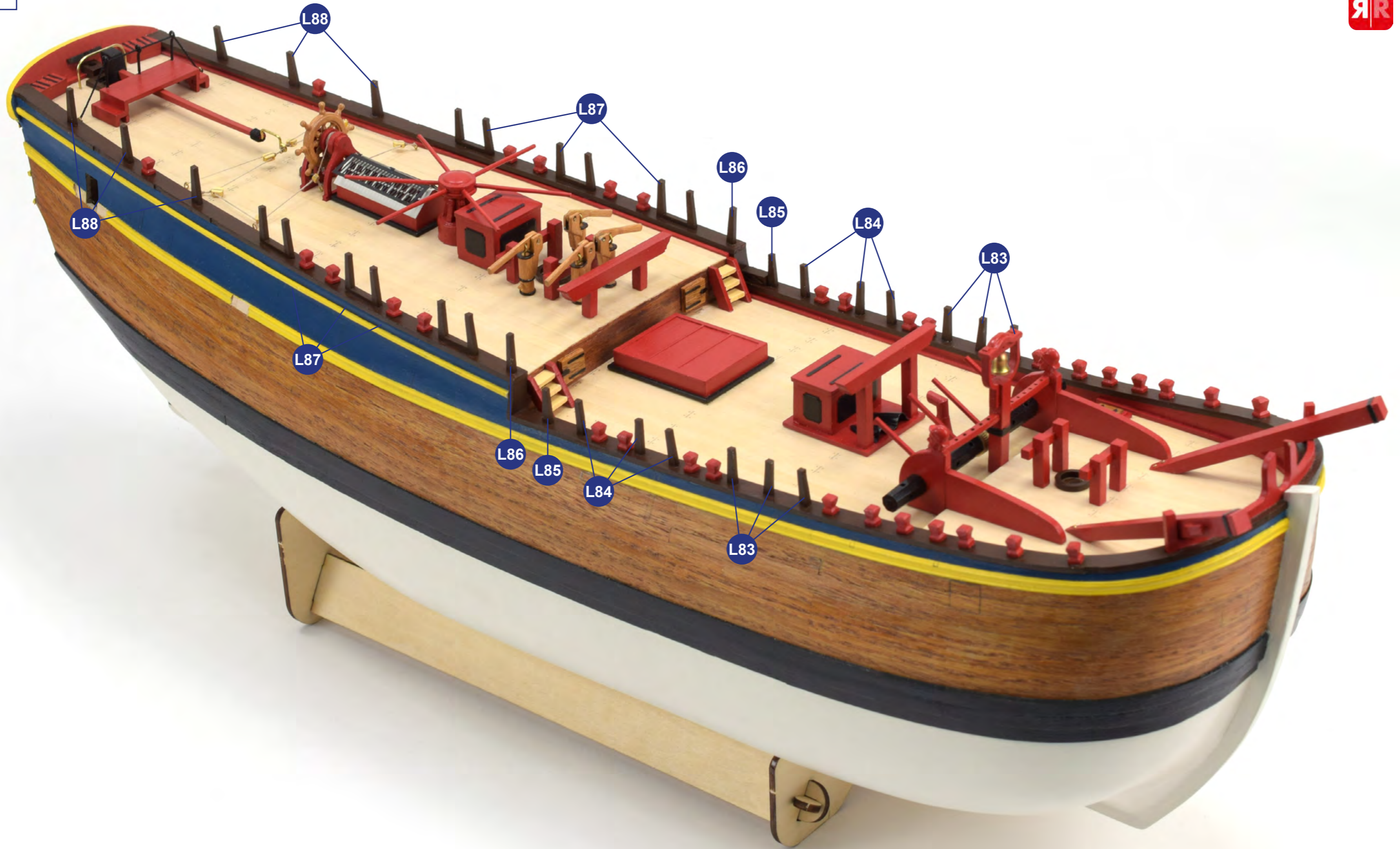



177

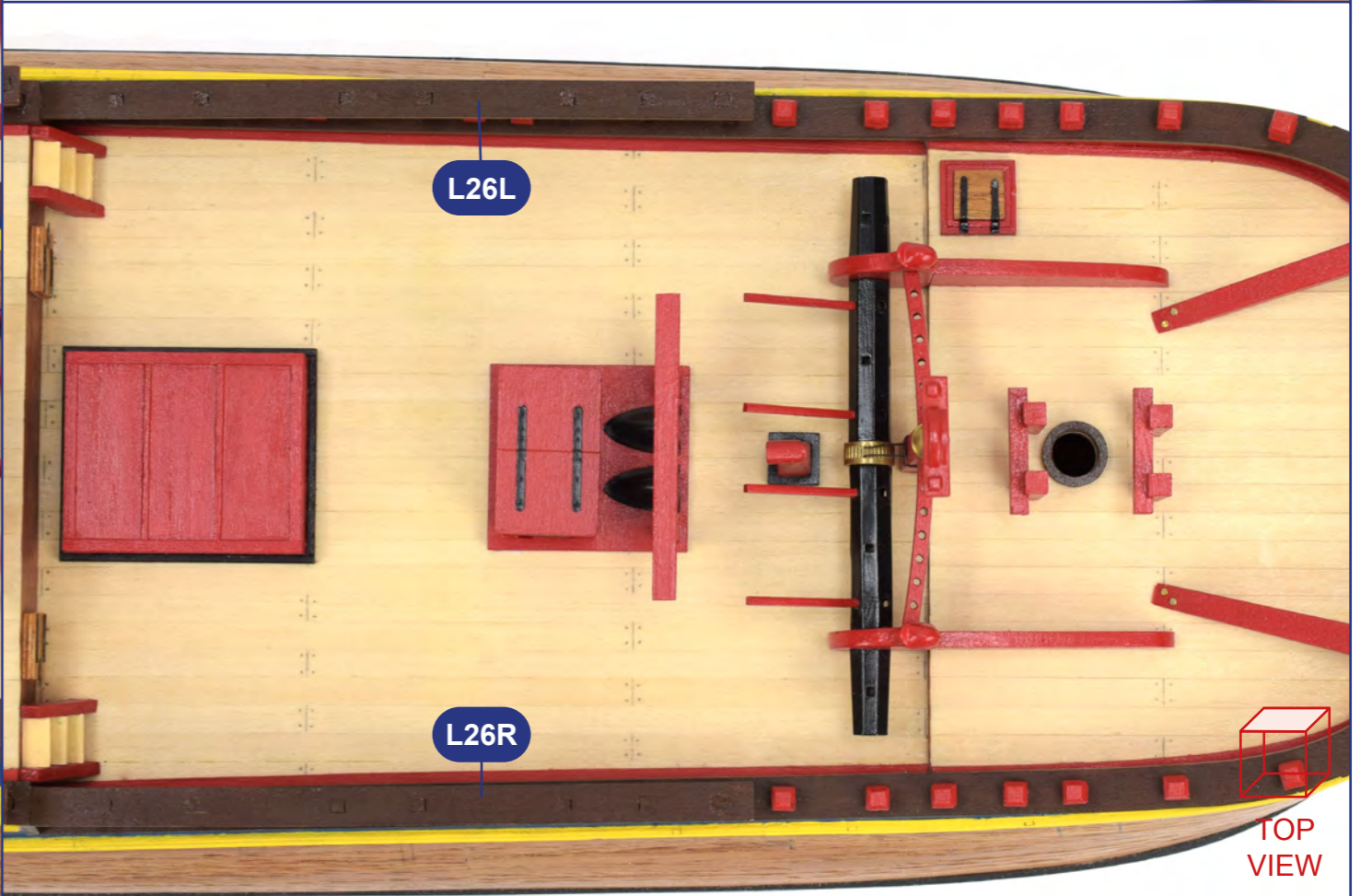
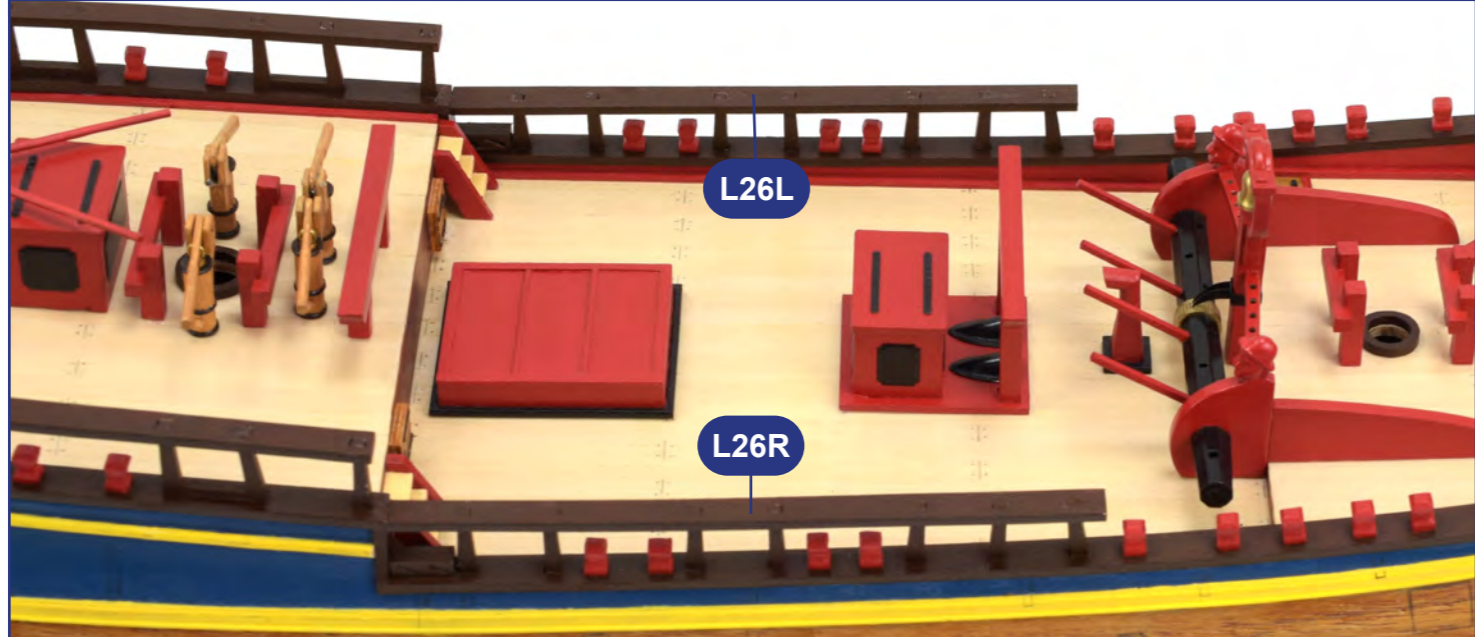
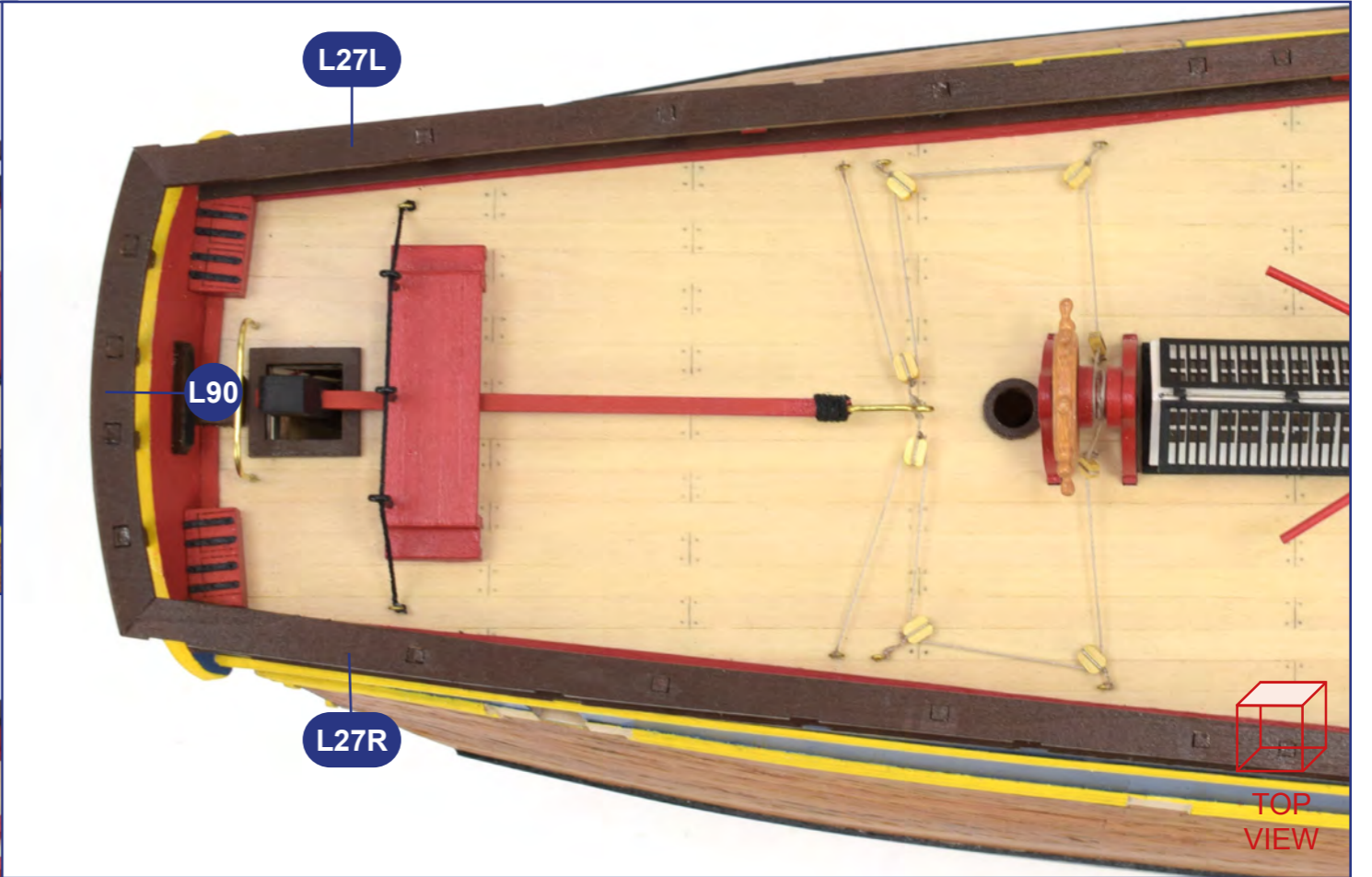
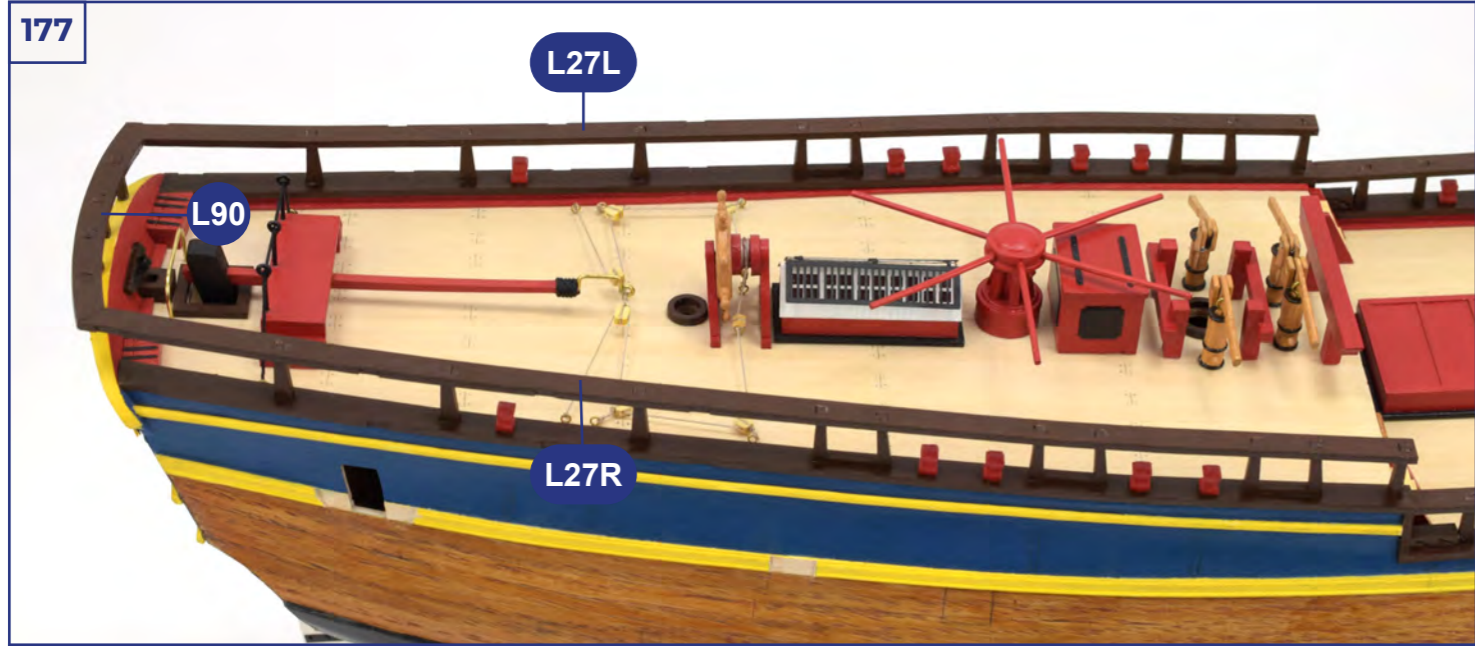

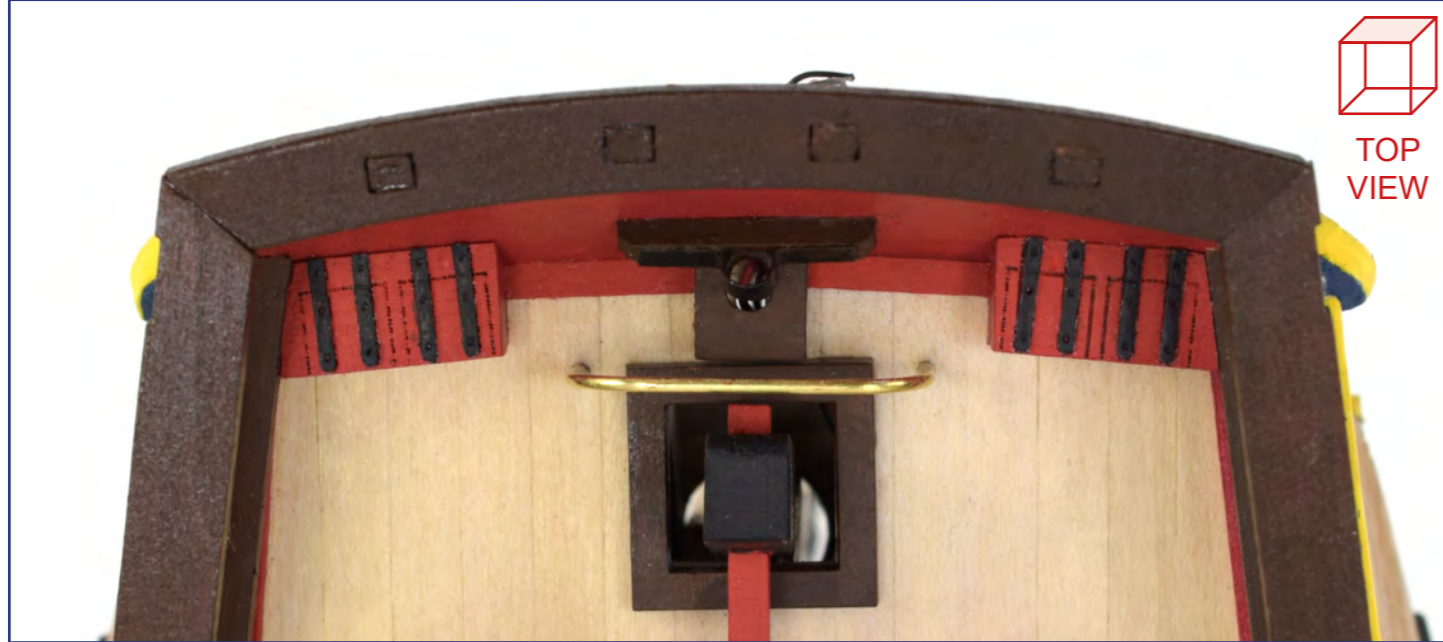
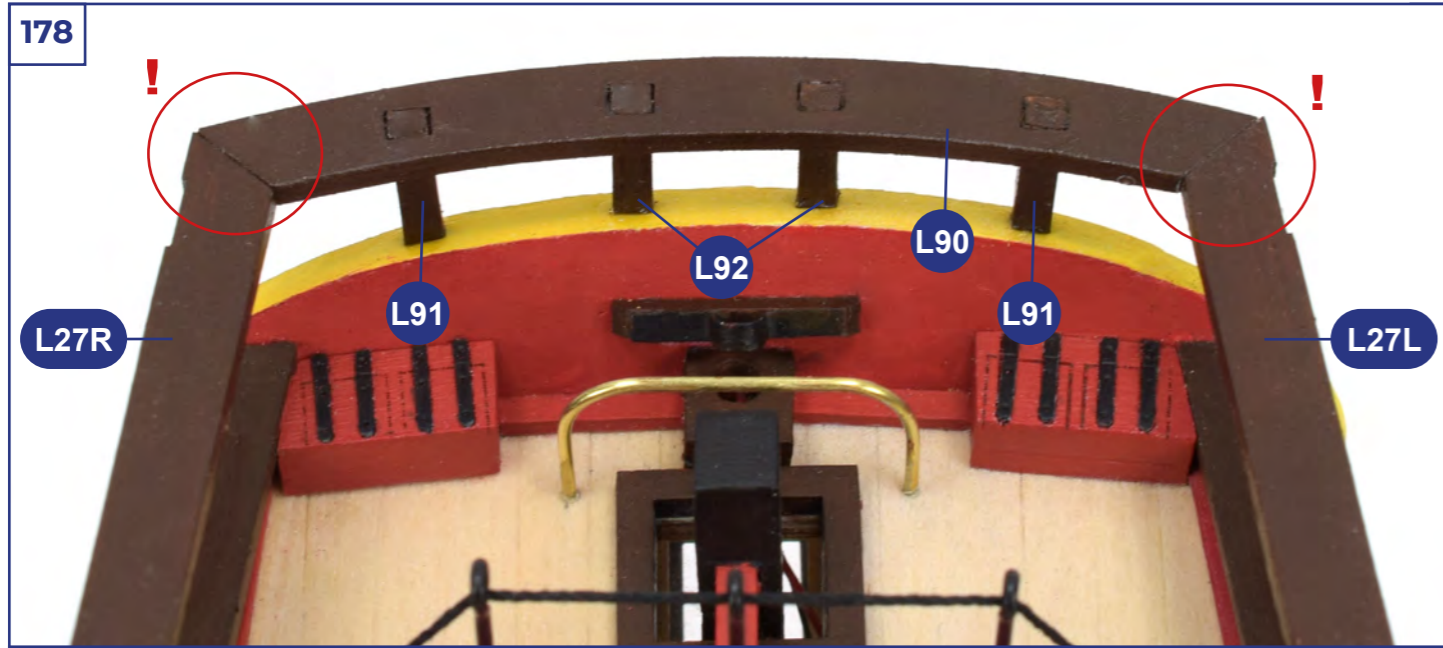

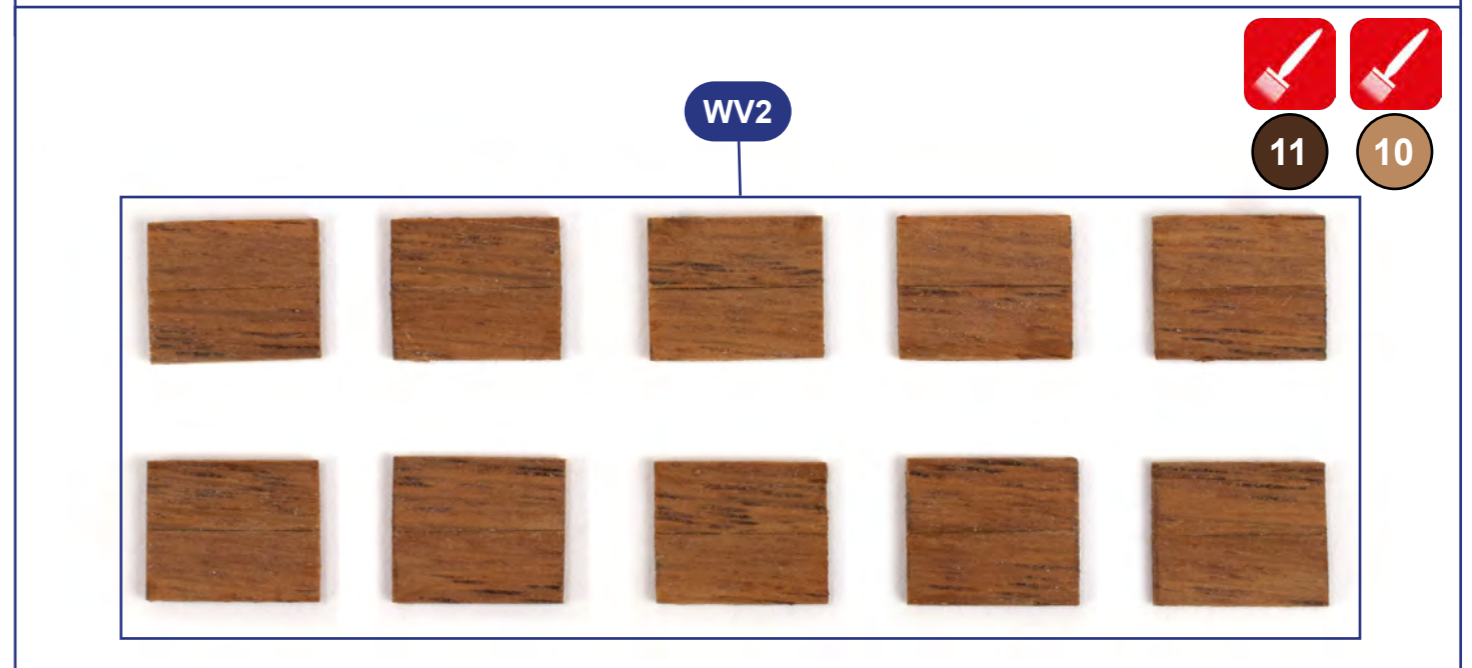
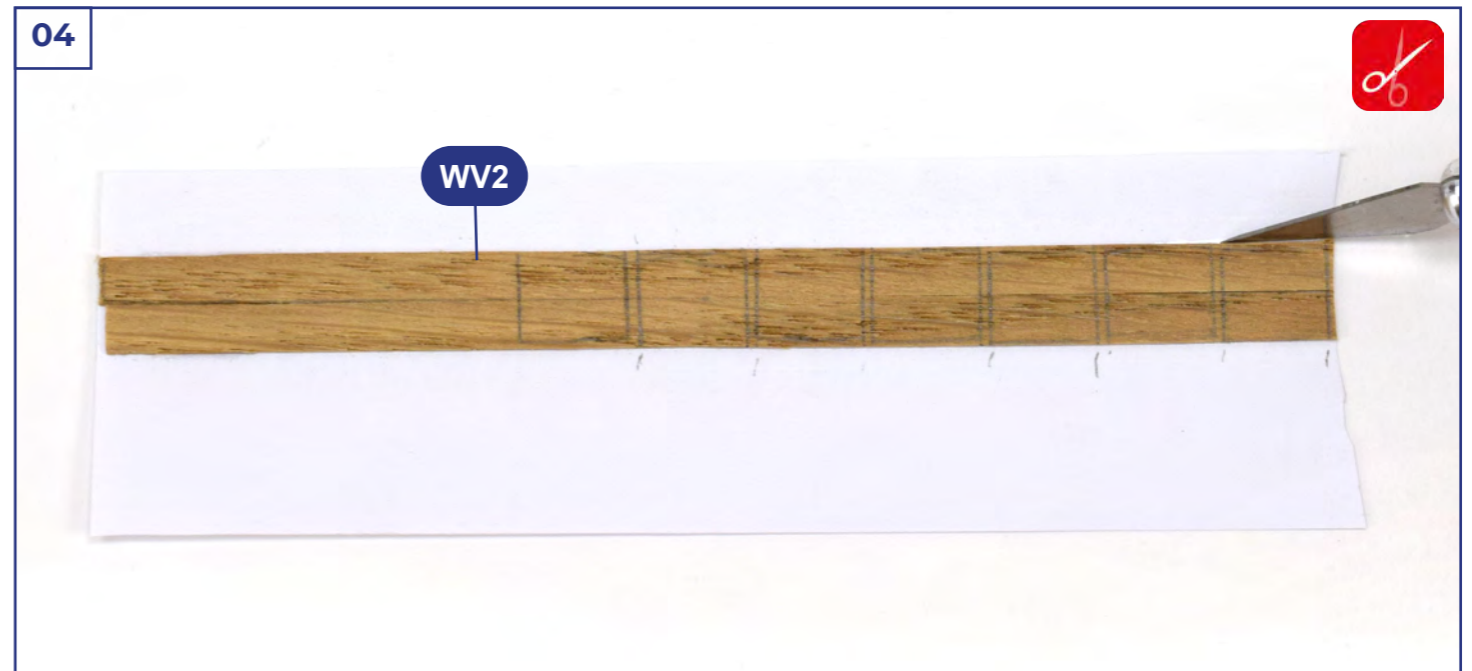
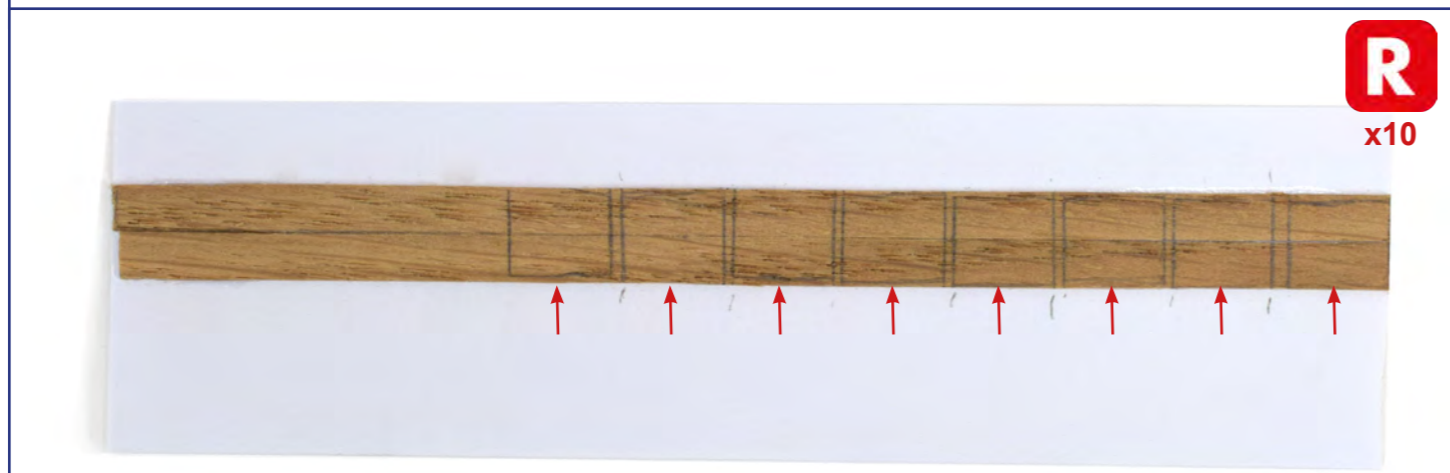
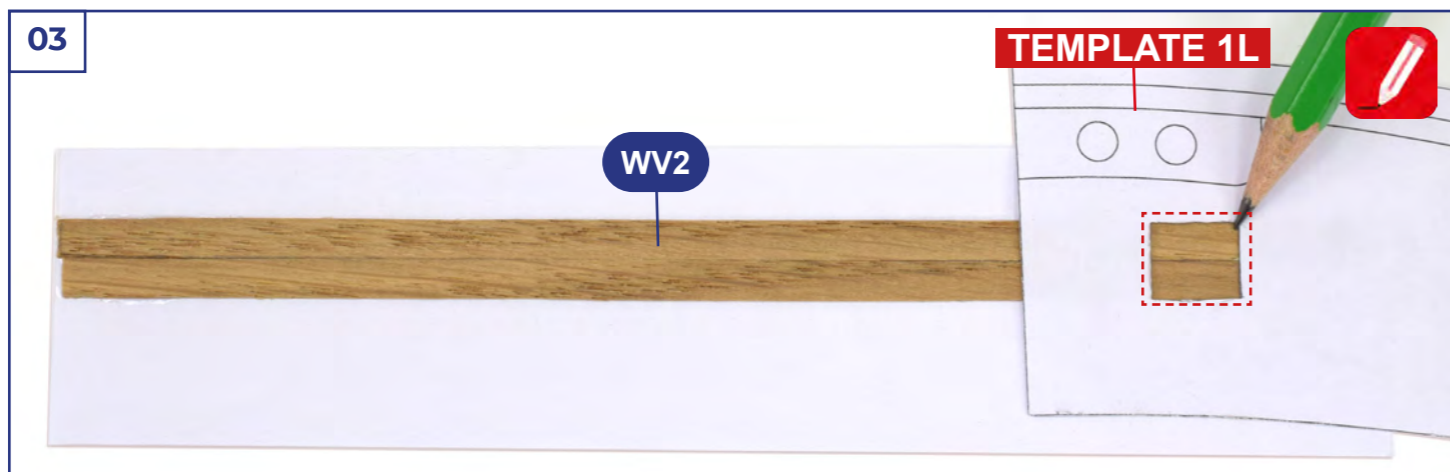
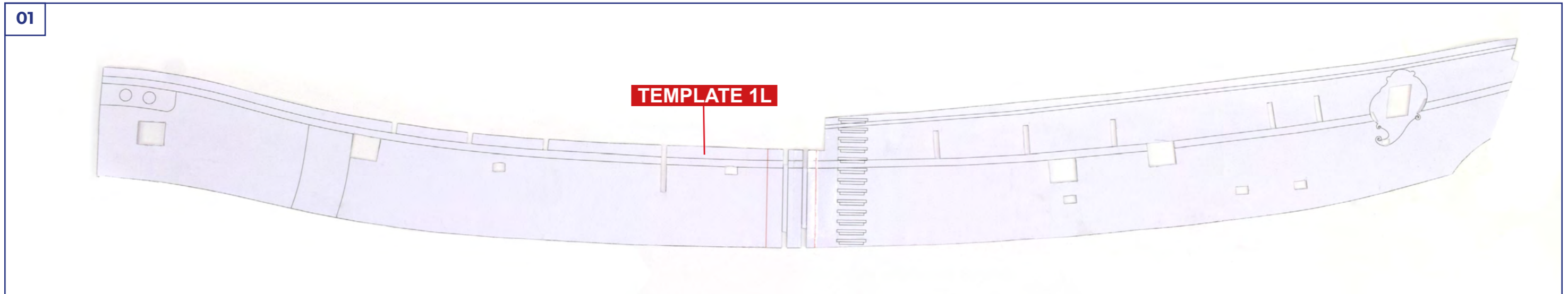

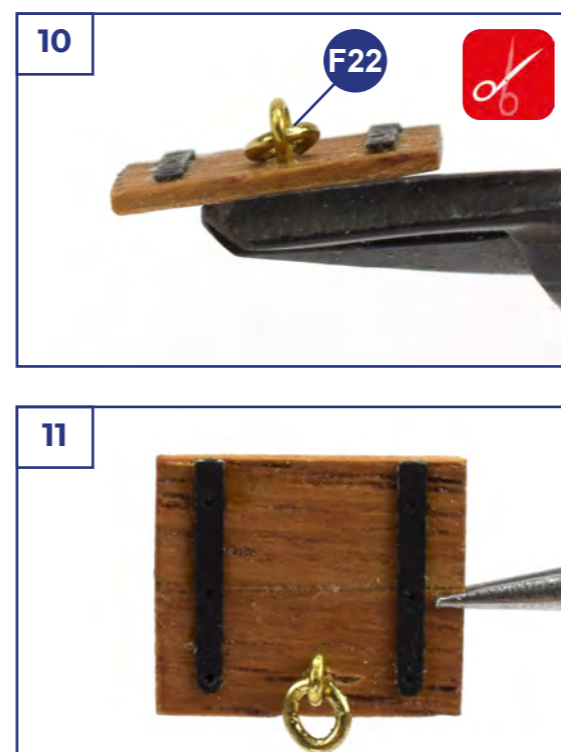
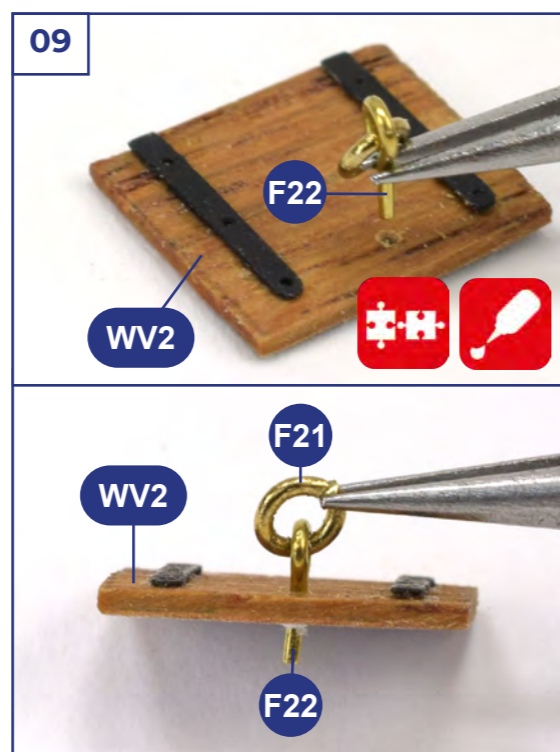
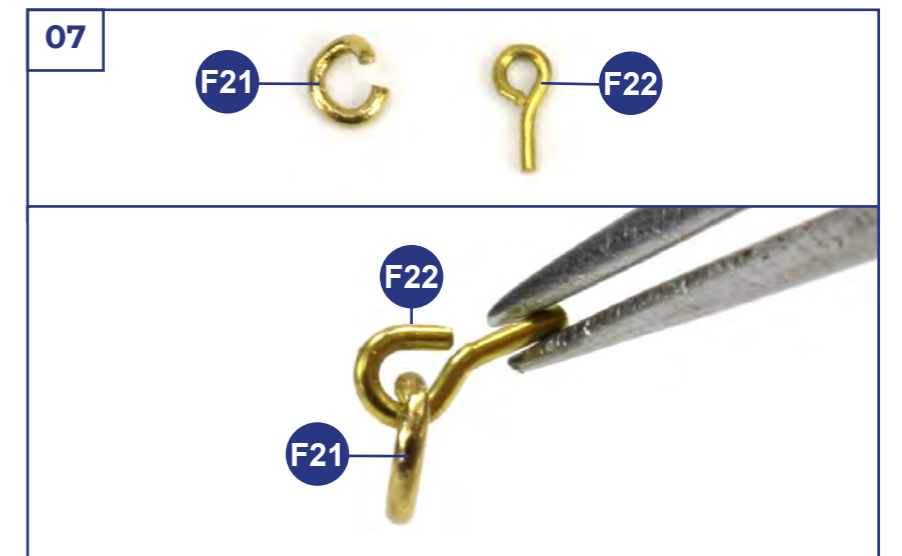
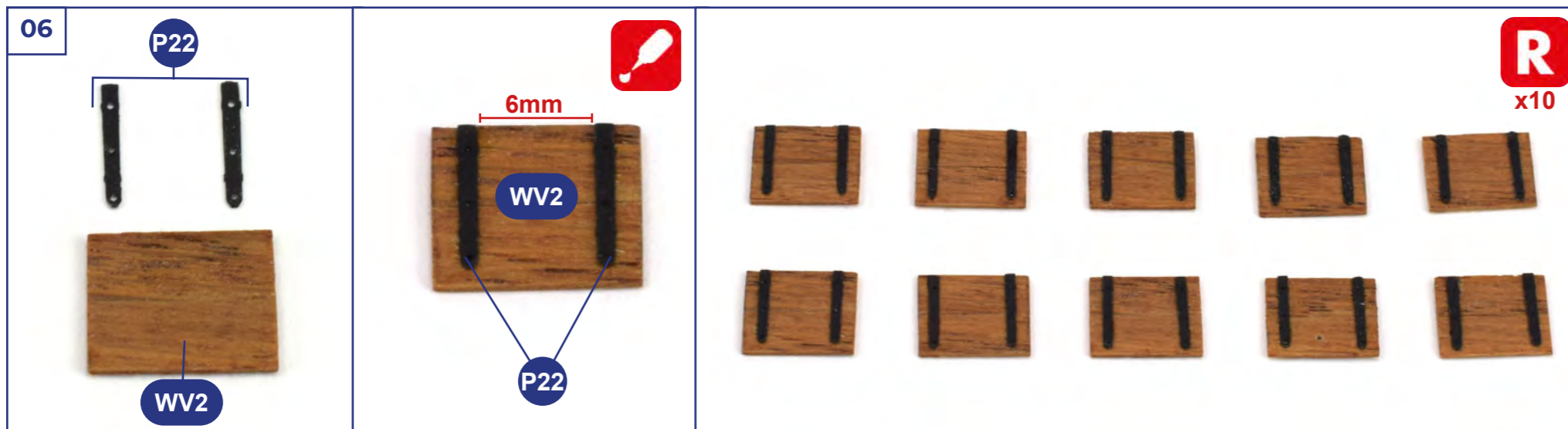

12

P21 x10

PRIMER

13

P21

11

14

P21

6

R x10

15

P7R, P7L, P8R, P8L, P6R, P6L, P9R, P9L, P5R, P5L

PRIMER

16

P7R, P7L, P8R, P8L, P6R, P6L, P9R, P9L, P5R, P5L

5

PRIMER

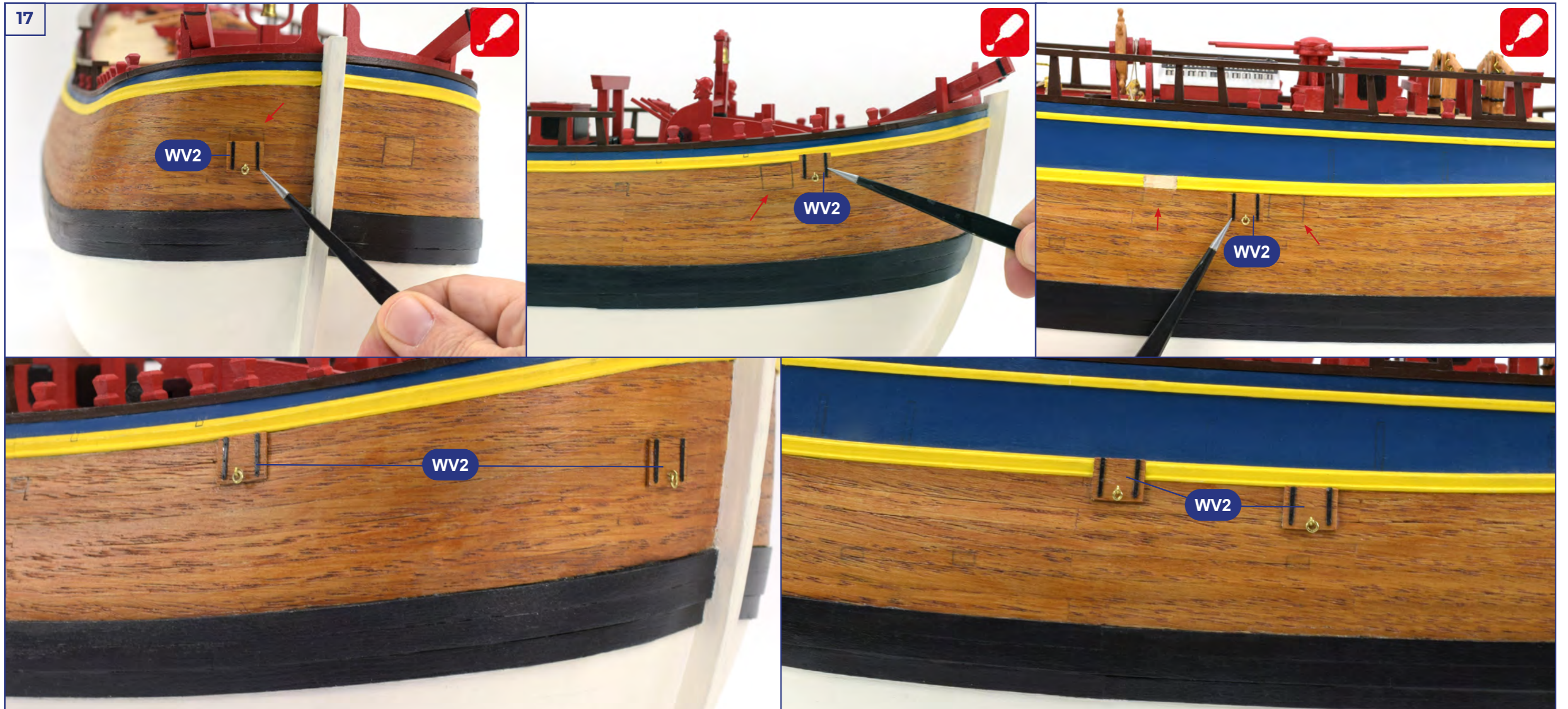

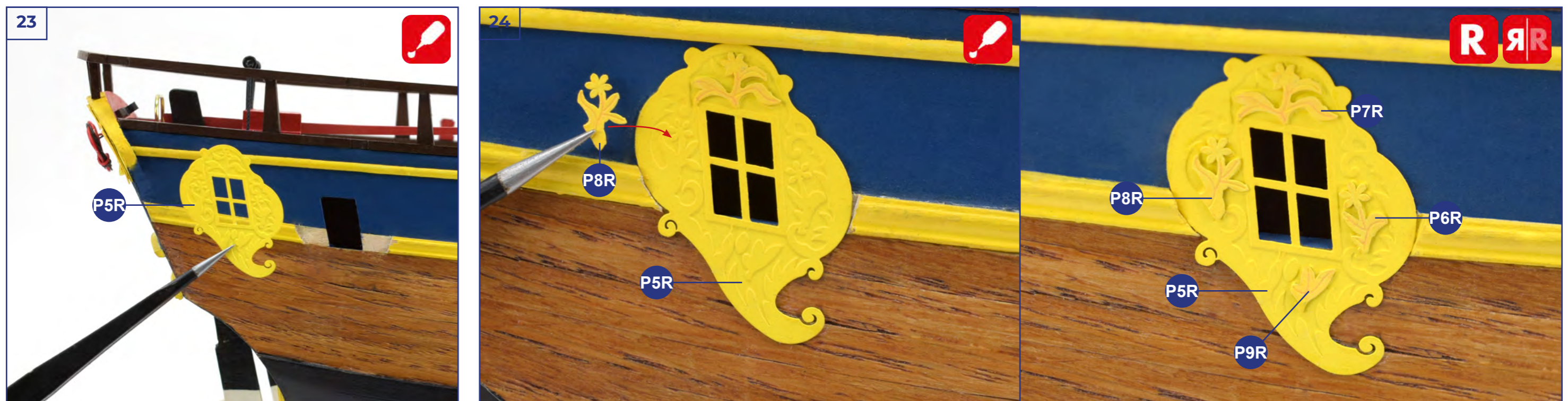
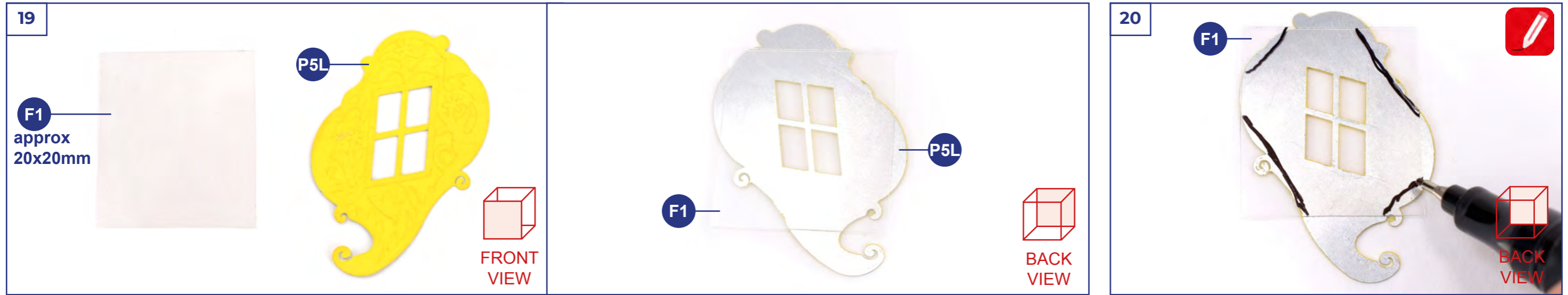

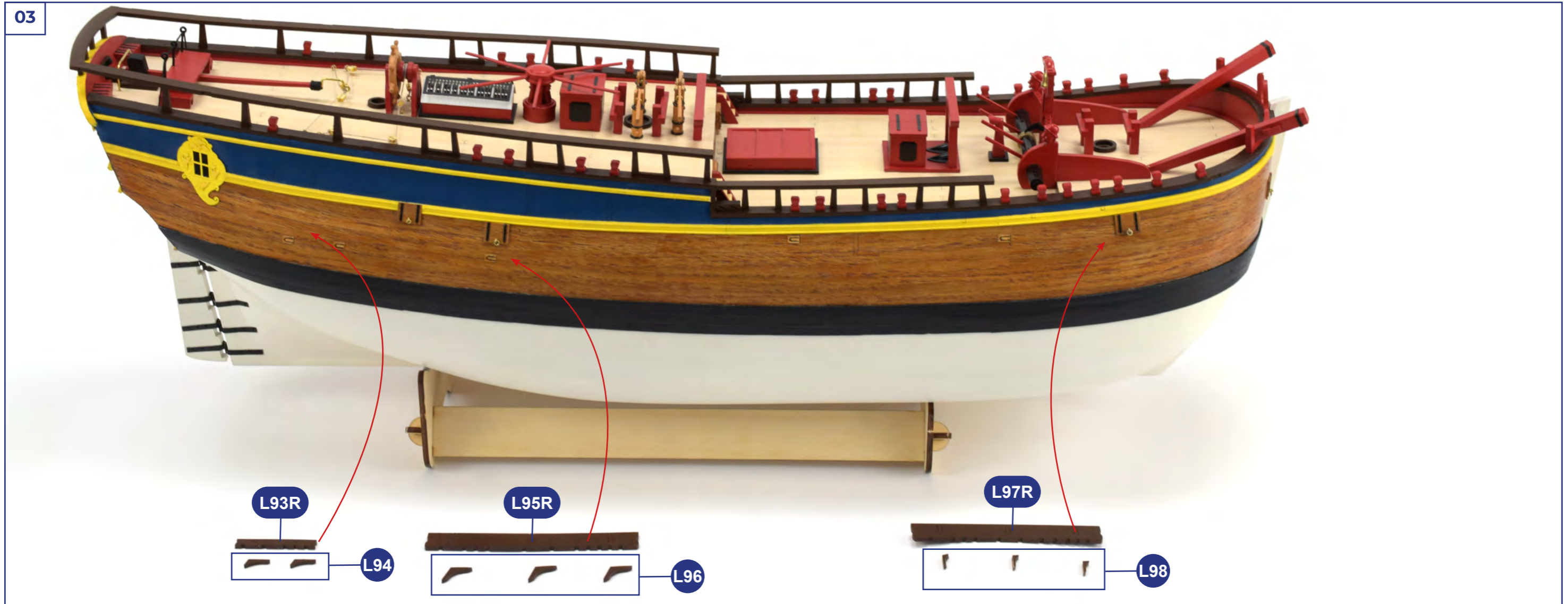
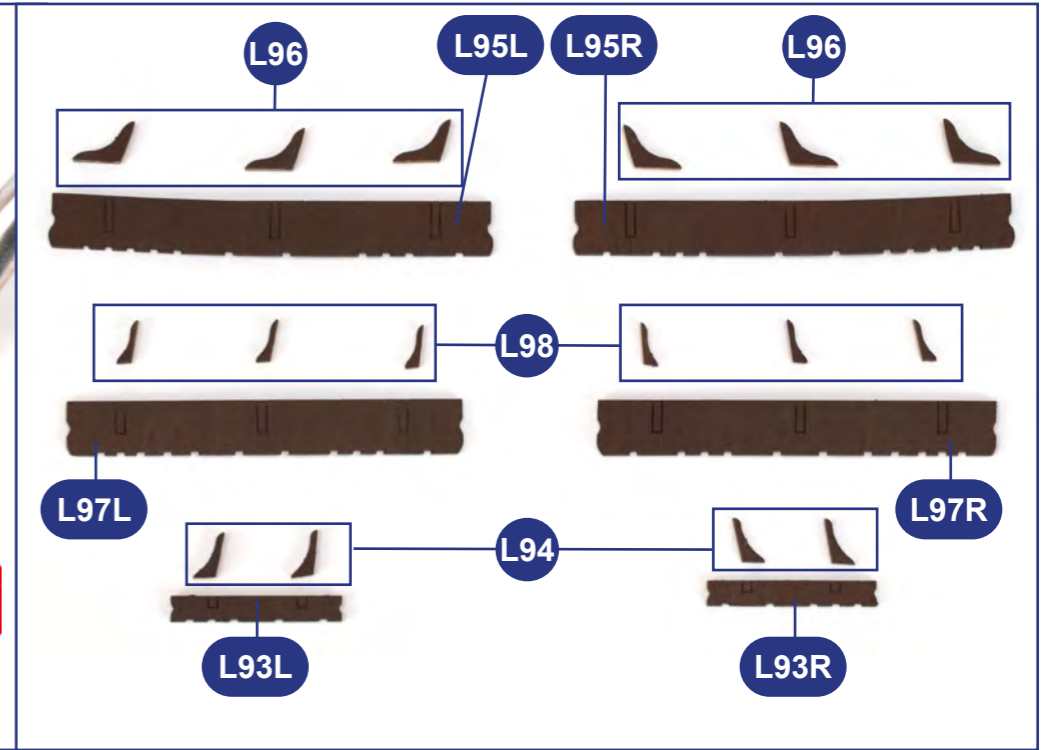
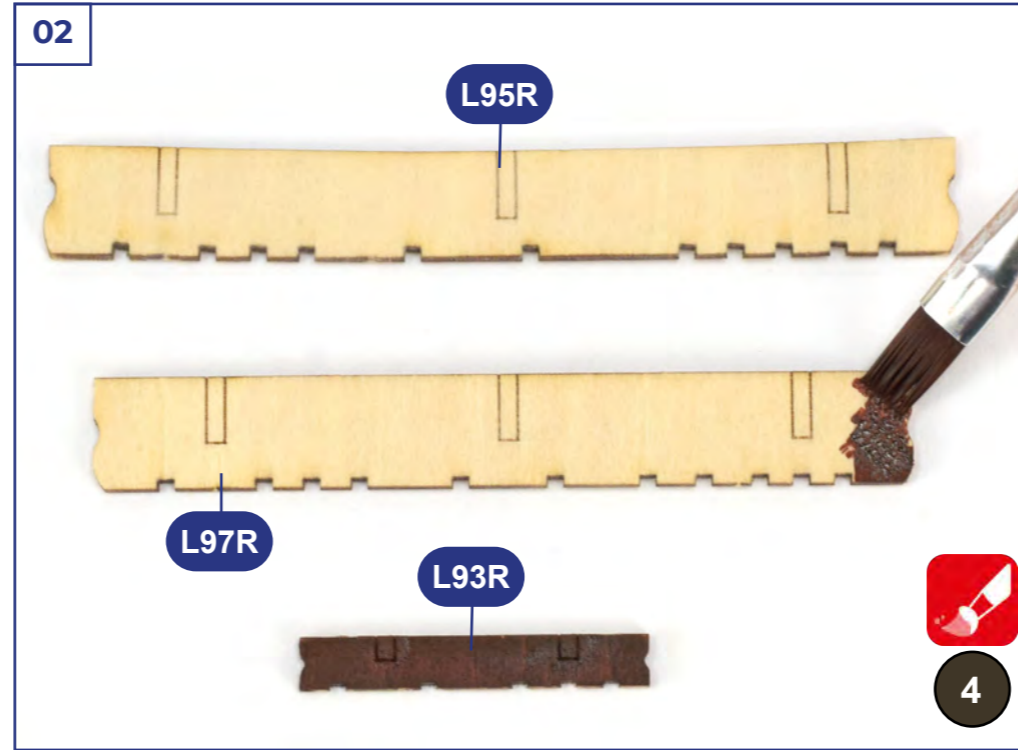
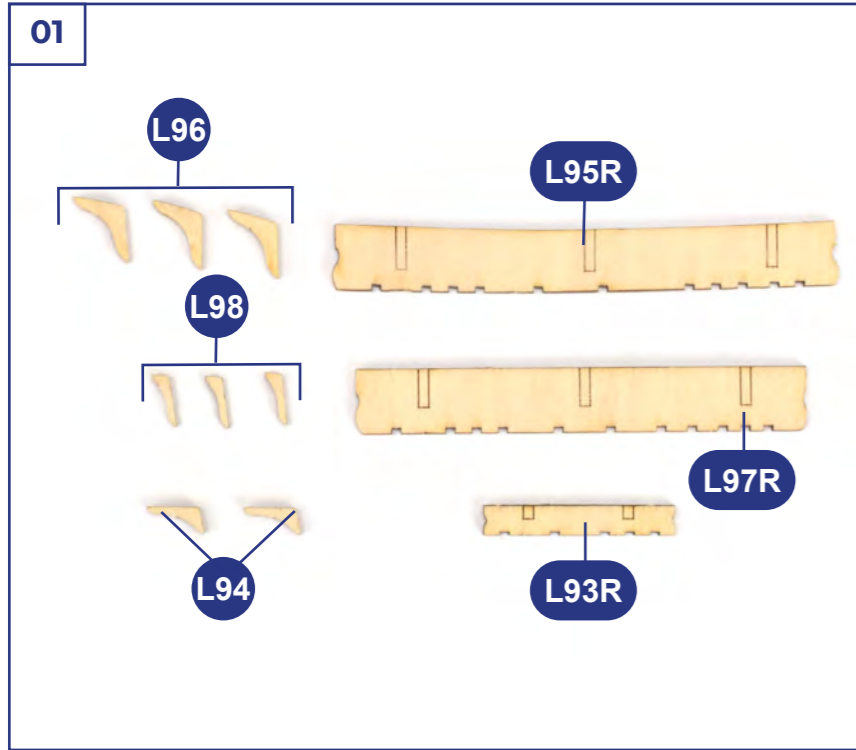

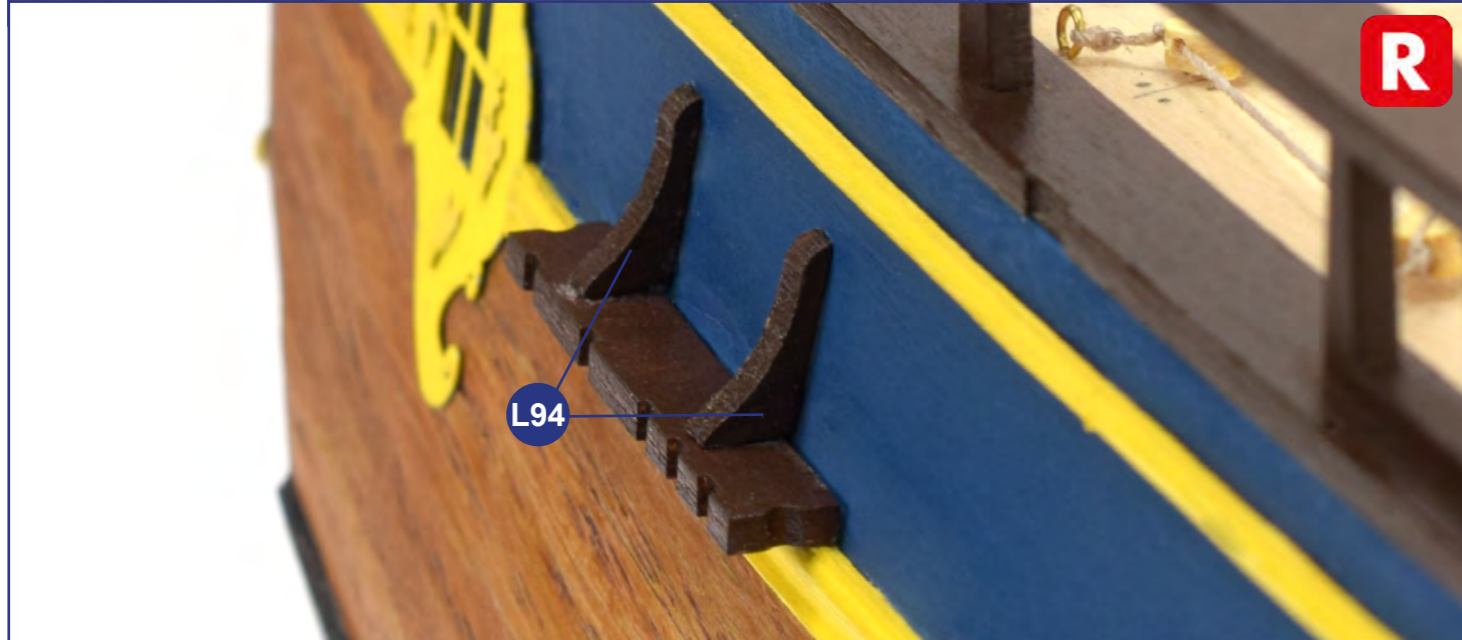
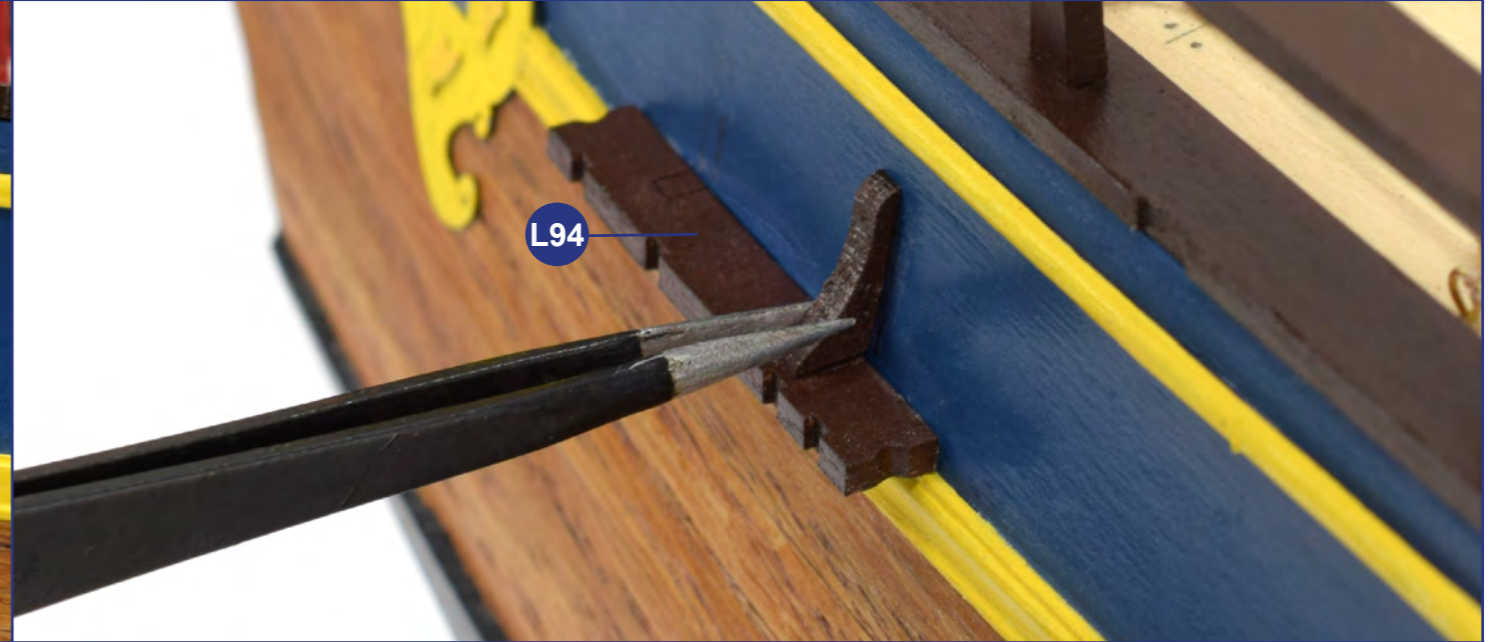
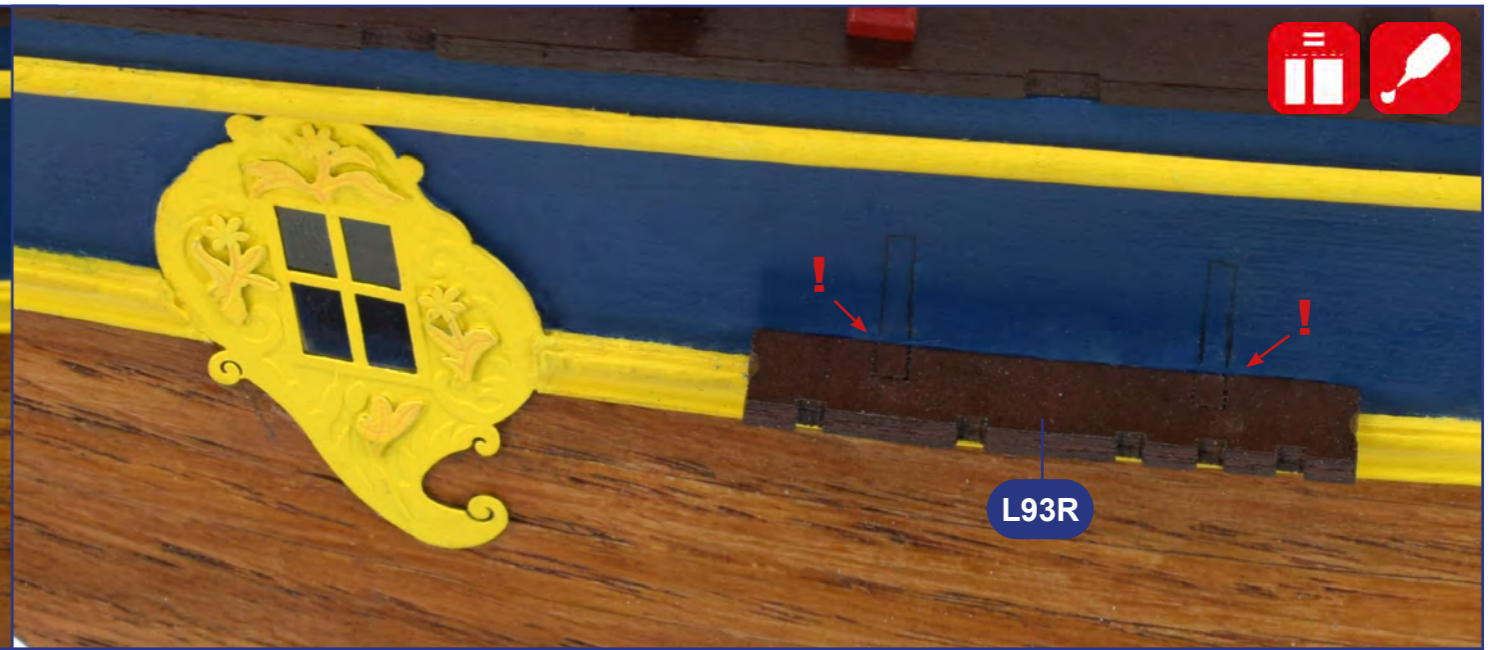
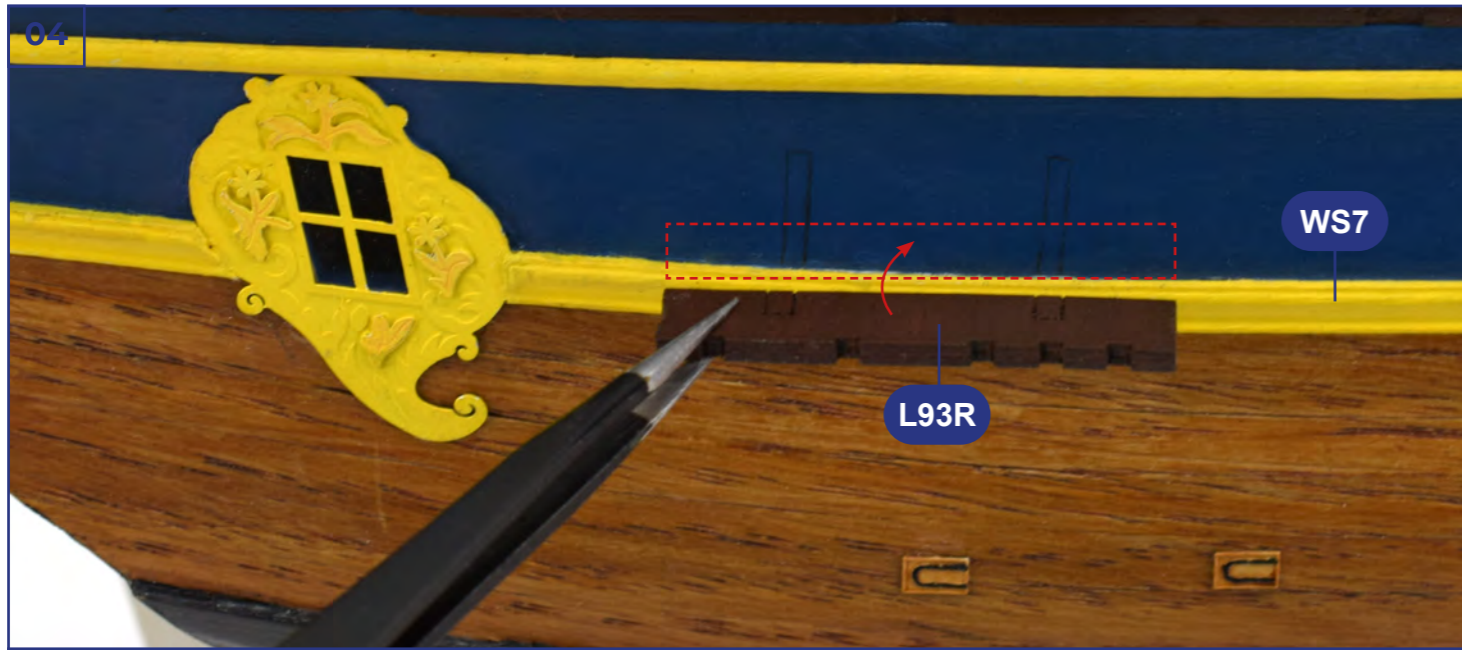

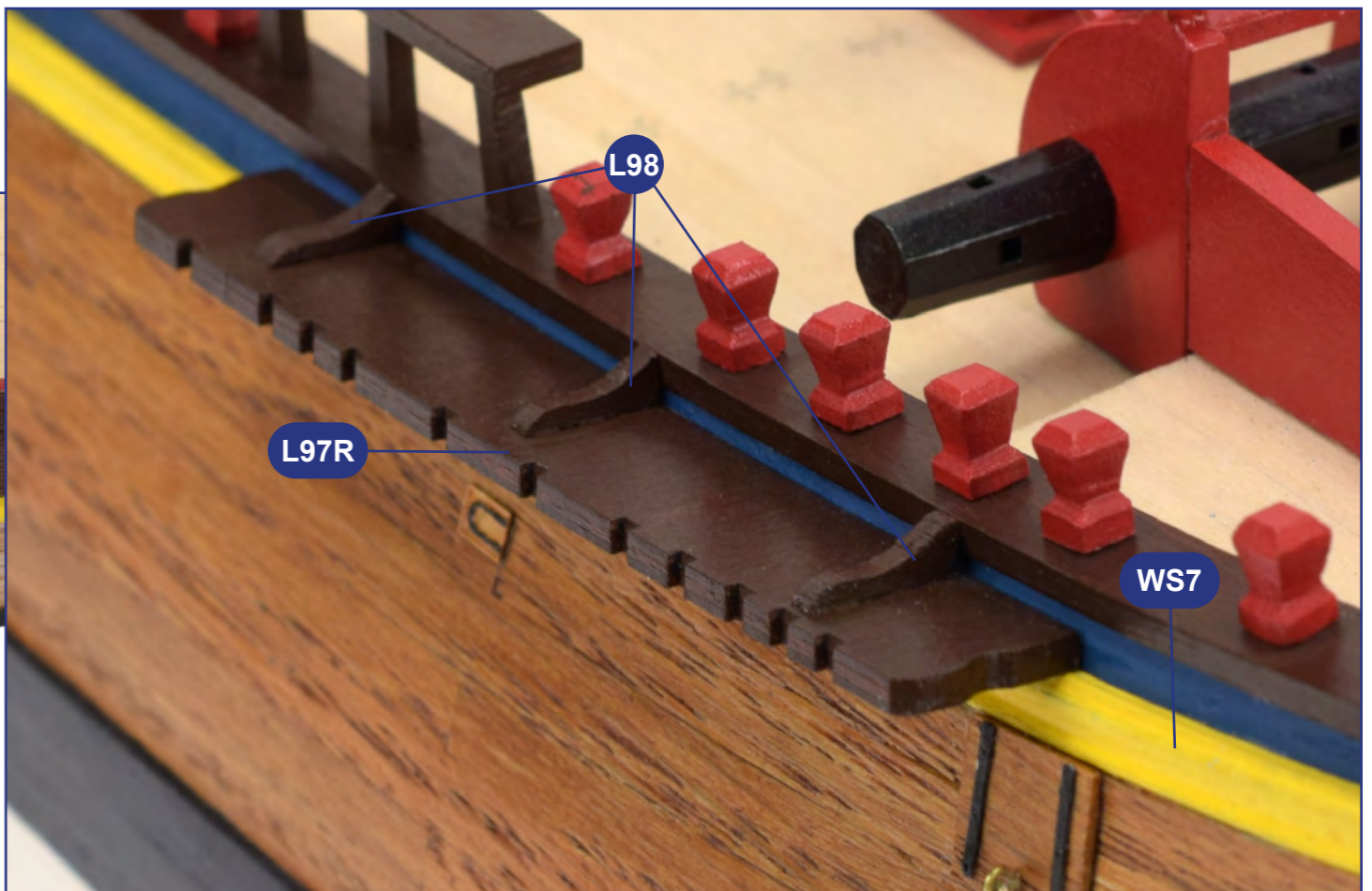
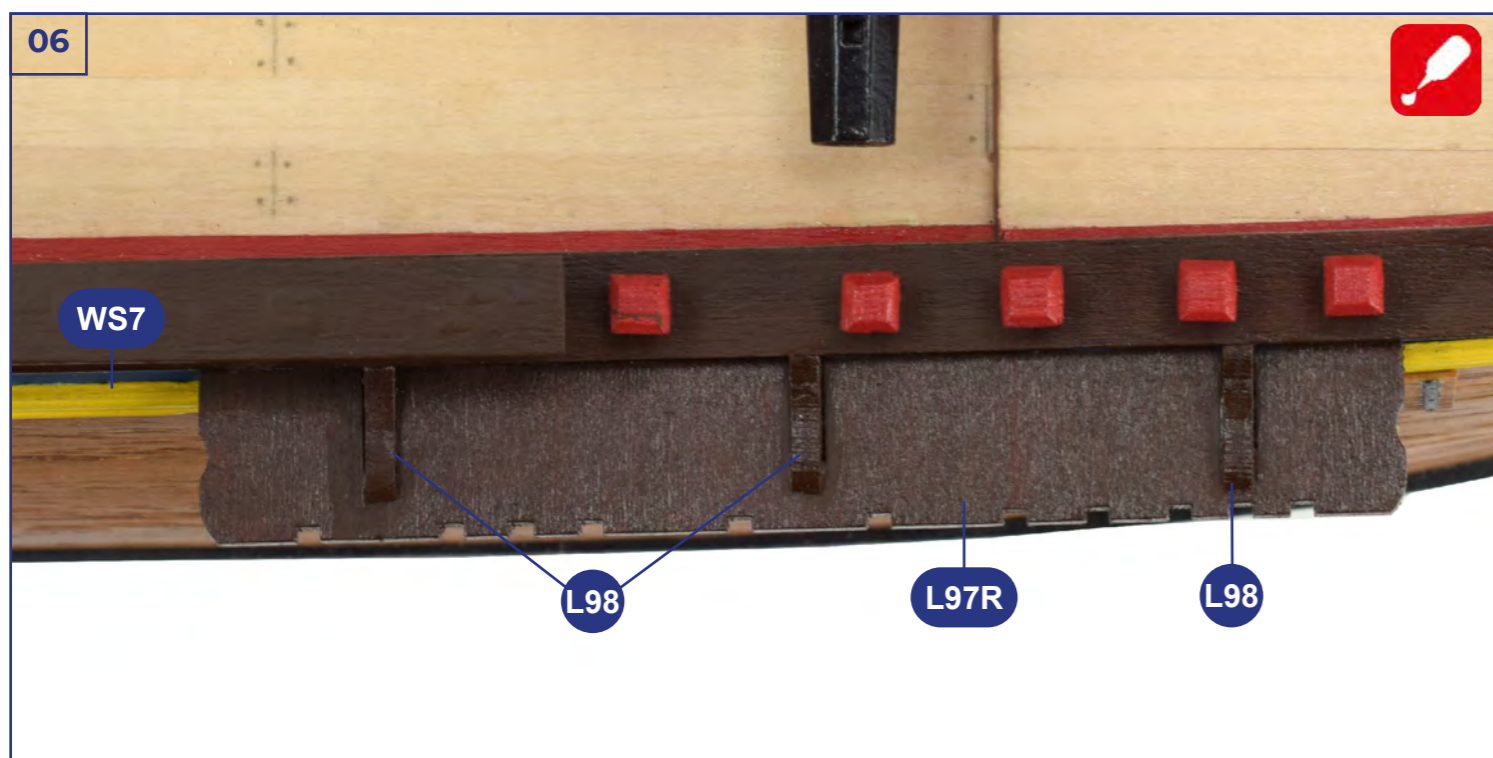
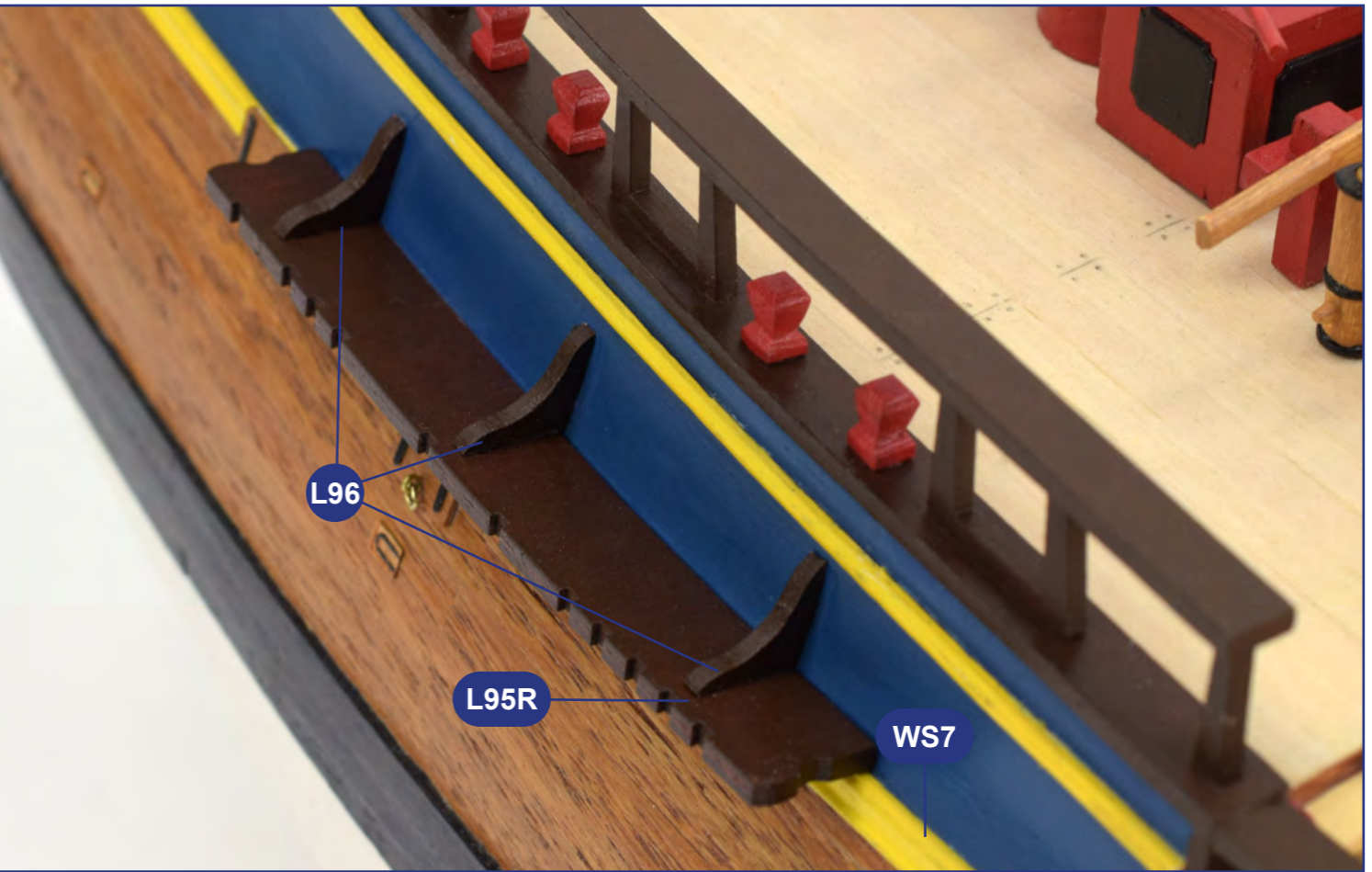
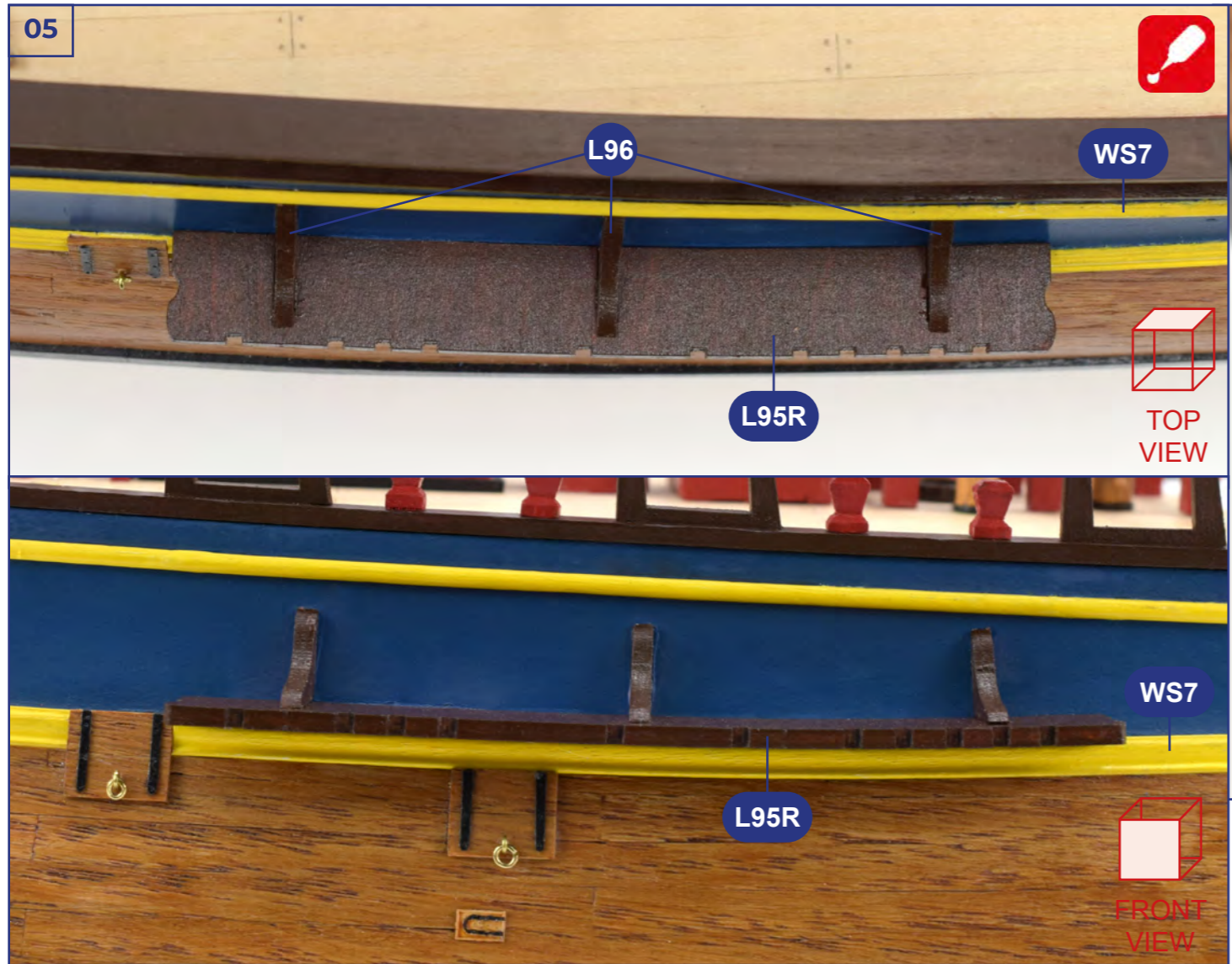

07

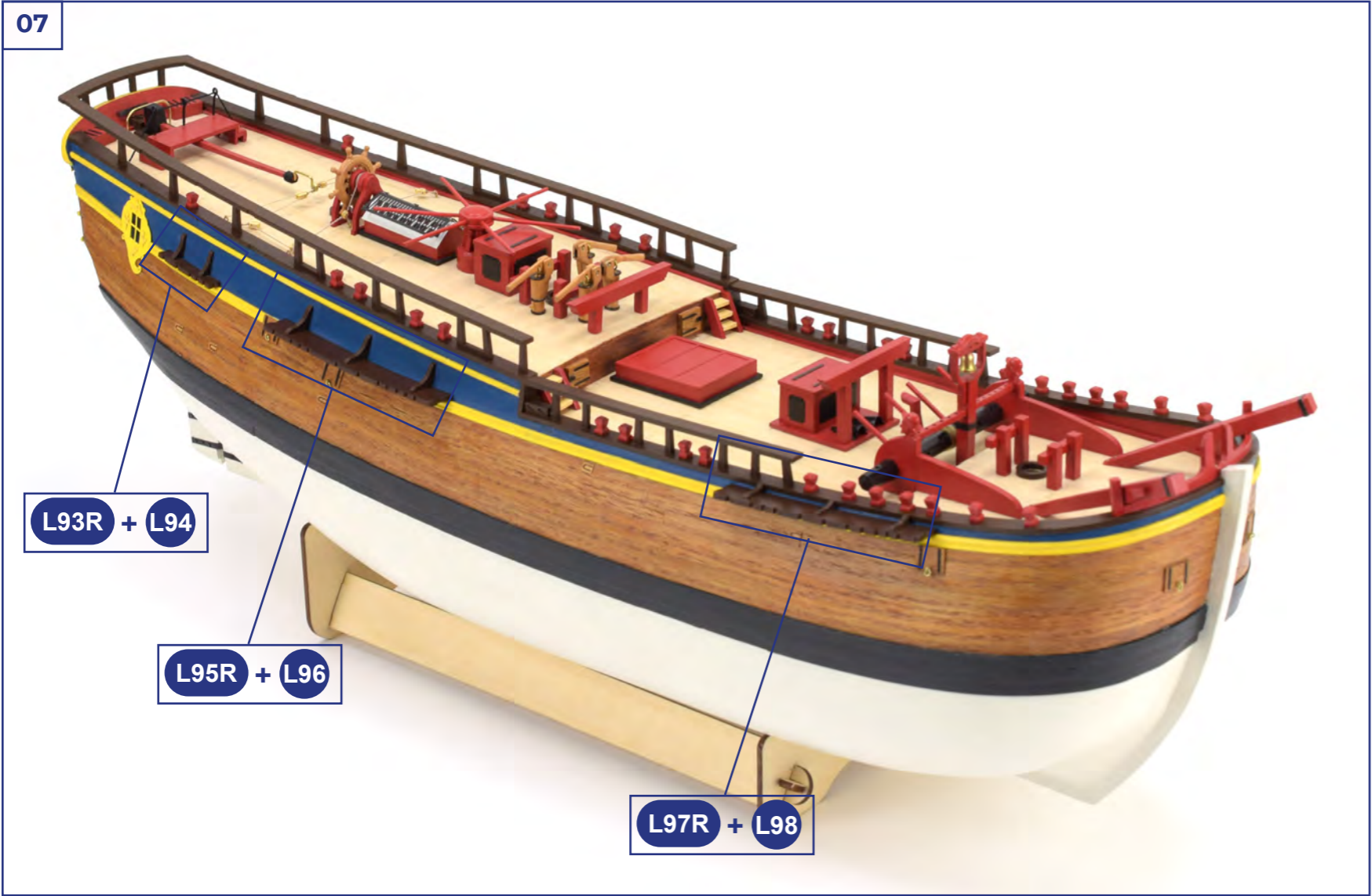

08

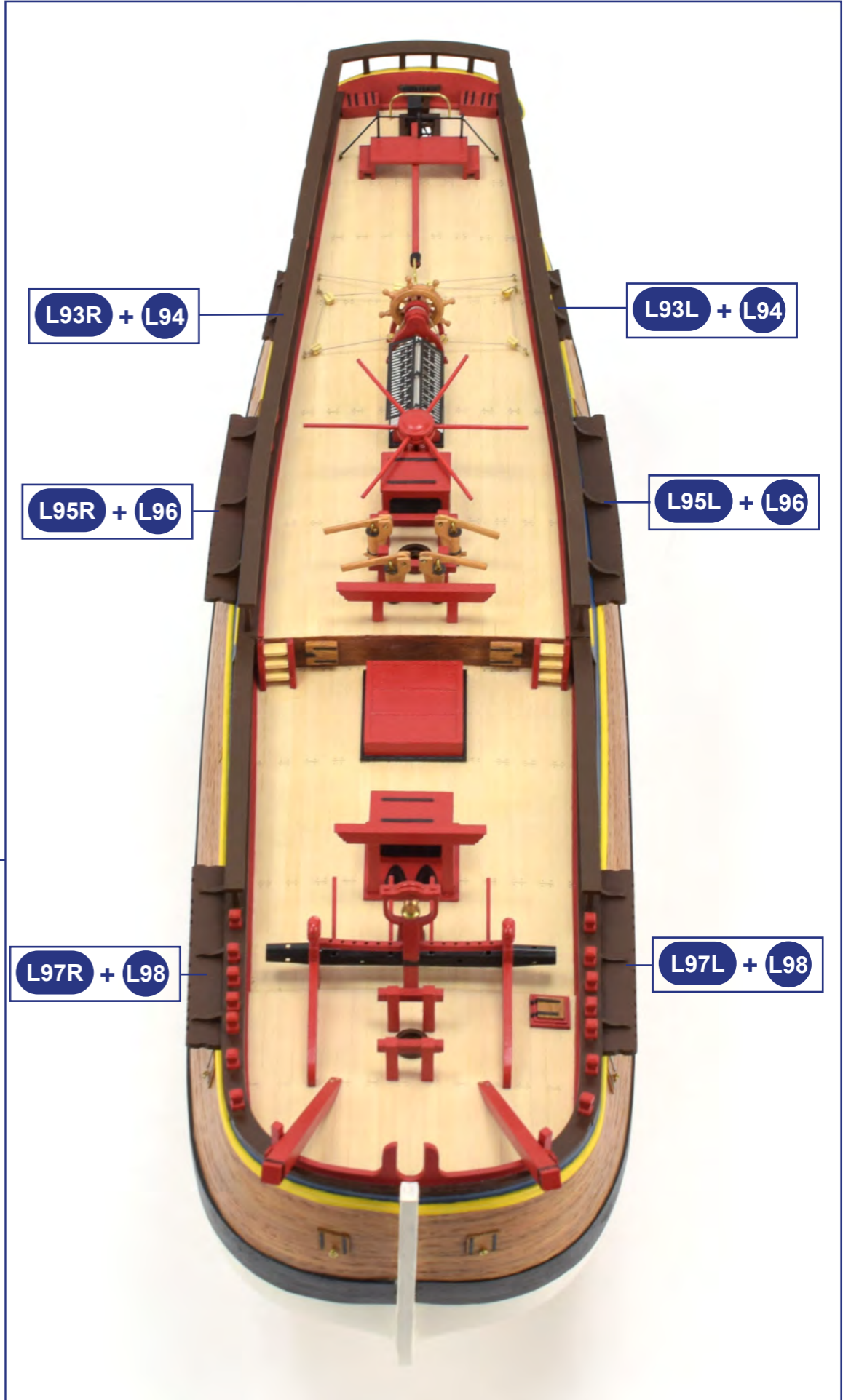

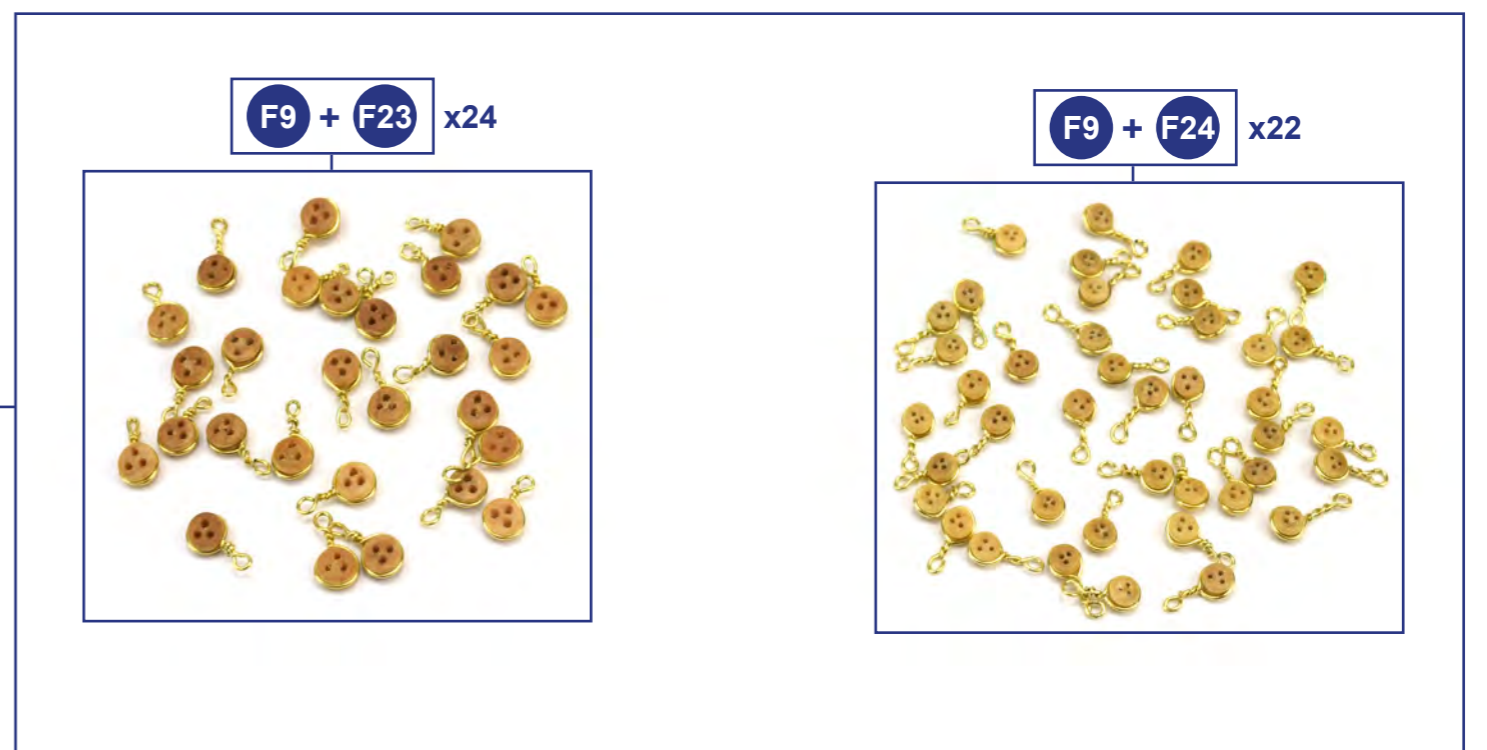
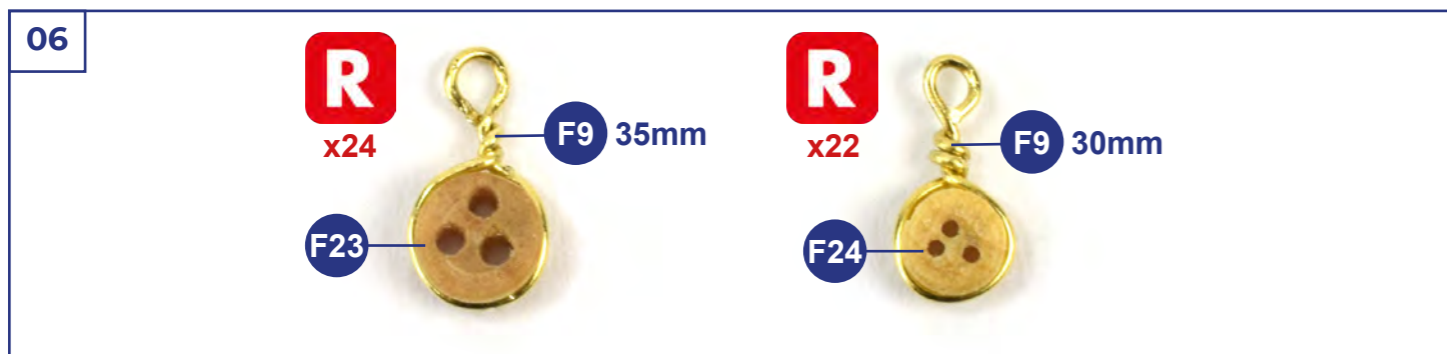
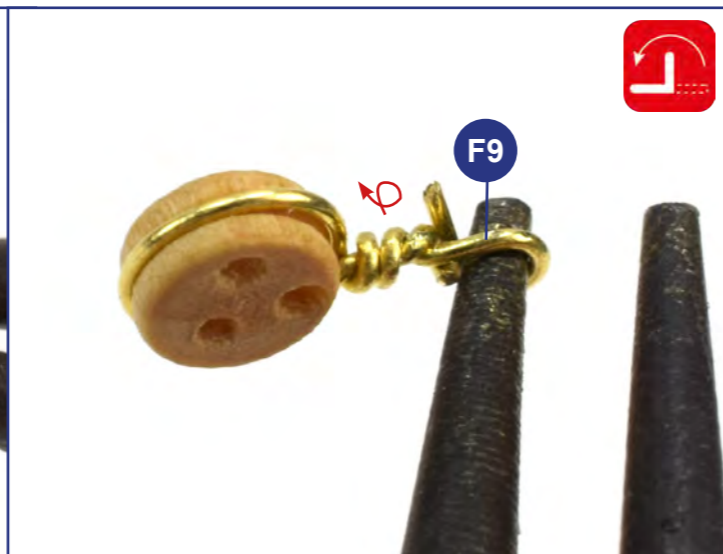
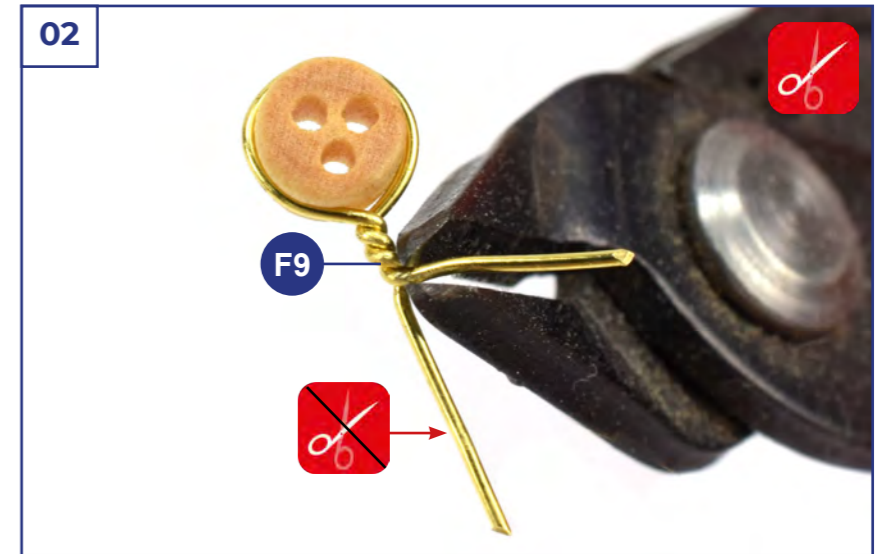

07

F23 + F9

F9 22mm

P42

F9 22mm

F9

08

P42

F9

F23 + F9

09

P43

F9 22mm

F9 20mm

F9 20mm

F9 20mm

F9 20mm

F9 22mm

P43

R x12

P42

F9

F23 + F9

R x24

P43

F9 22mm

F9 20mm

F9 20mm

10

F9 20mm

F9 20mm

R x2

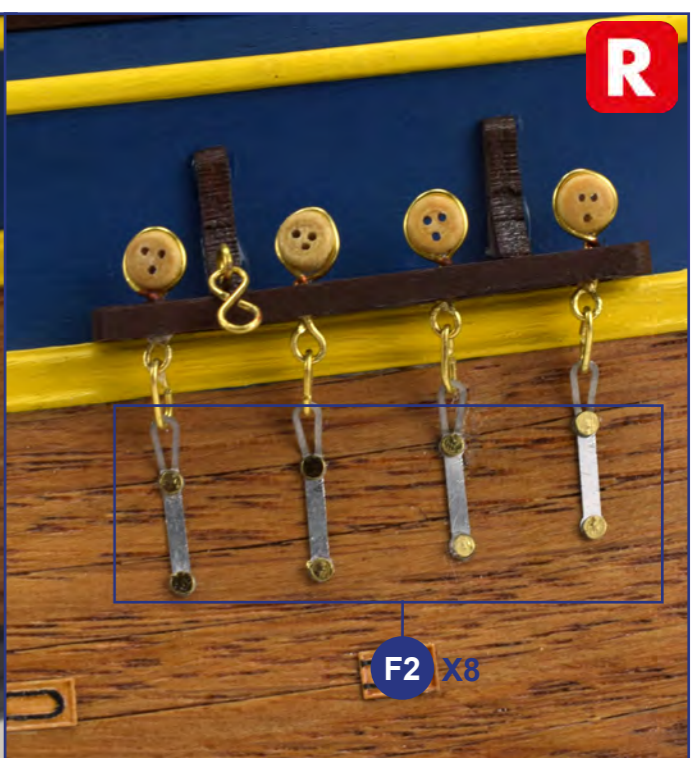
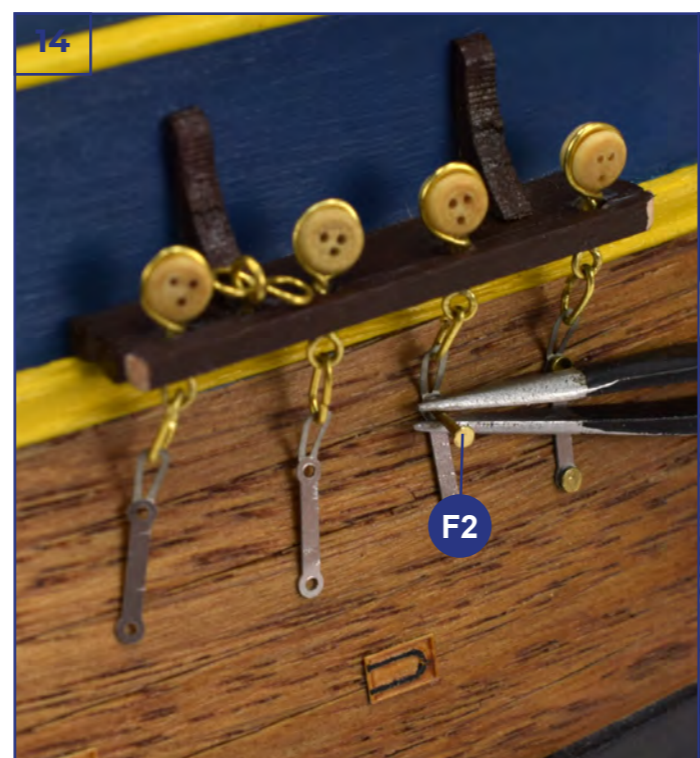
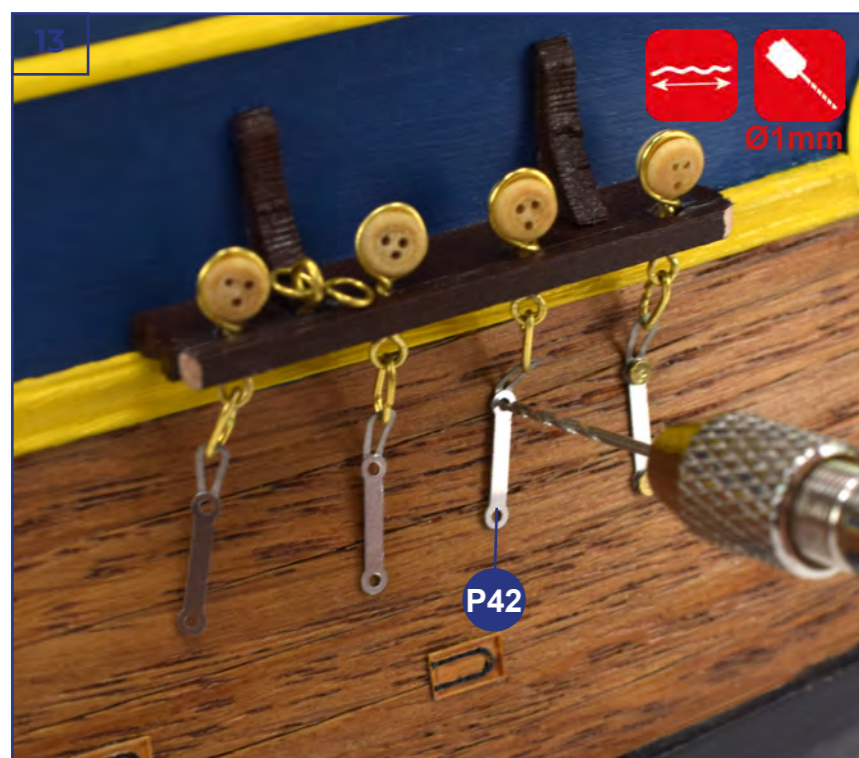
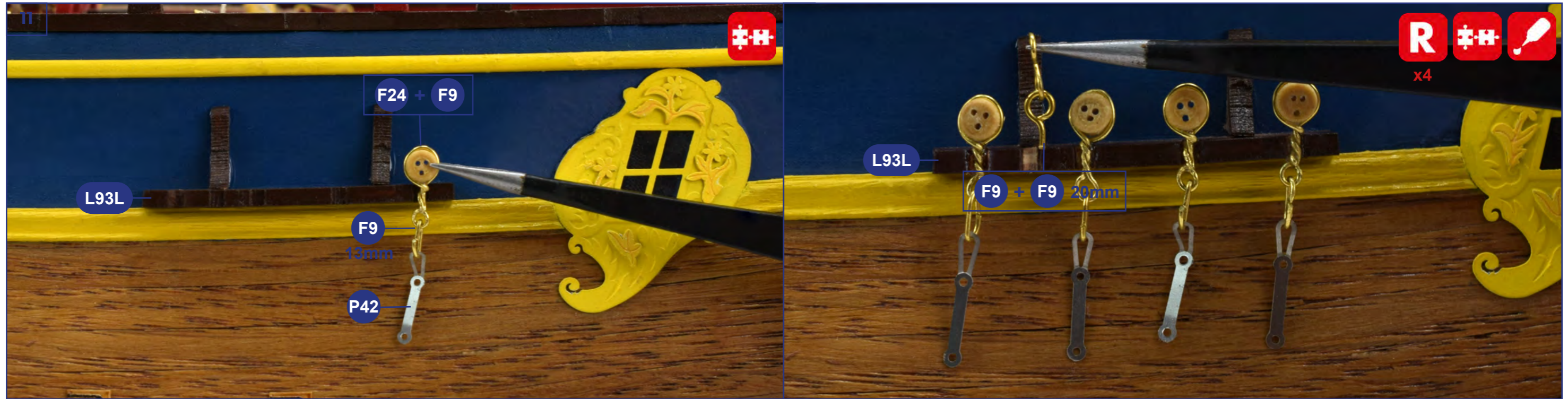

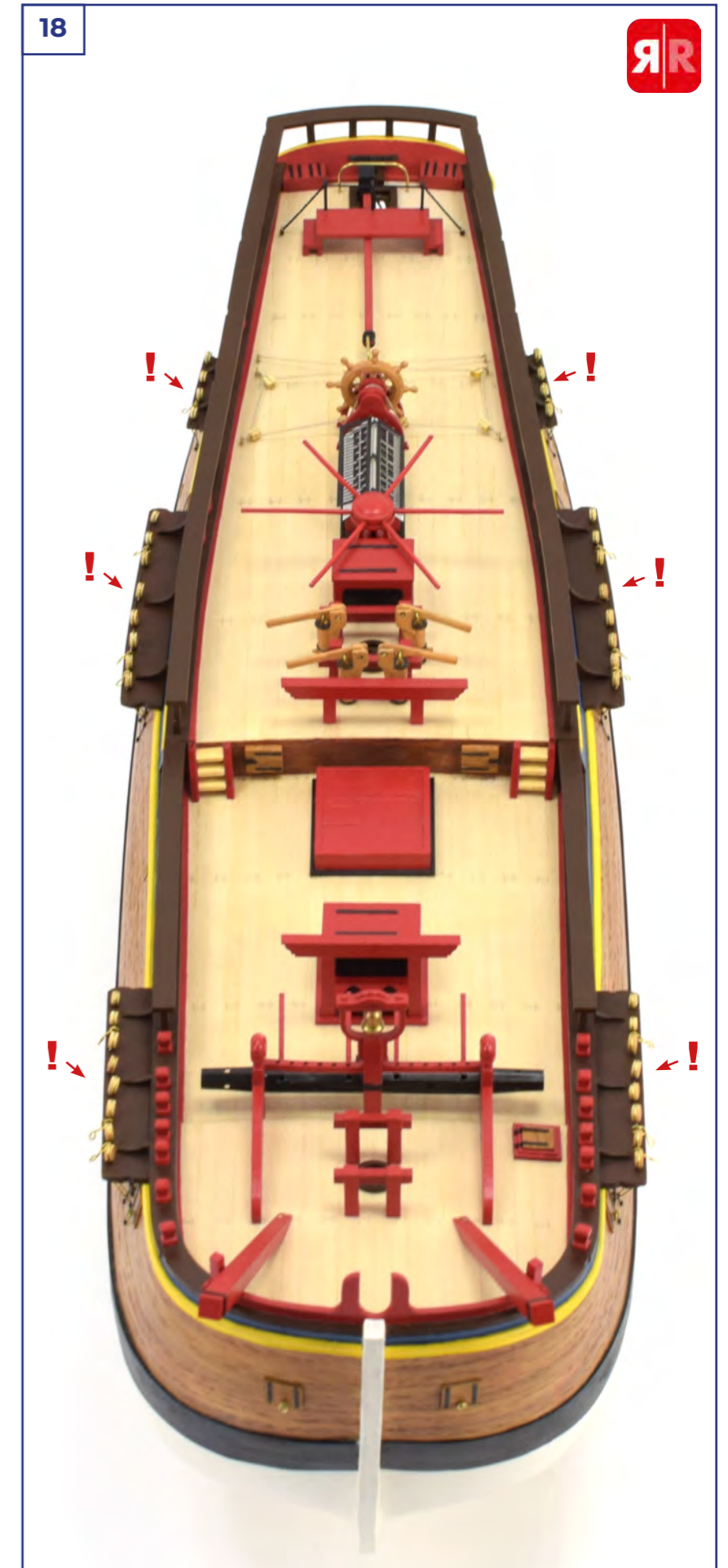
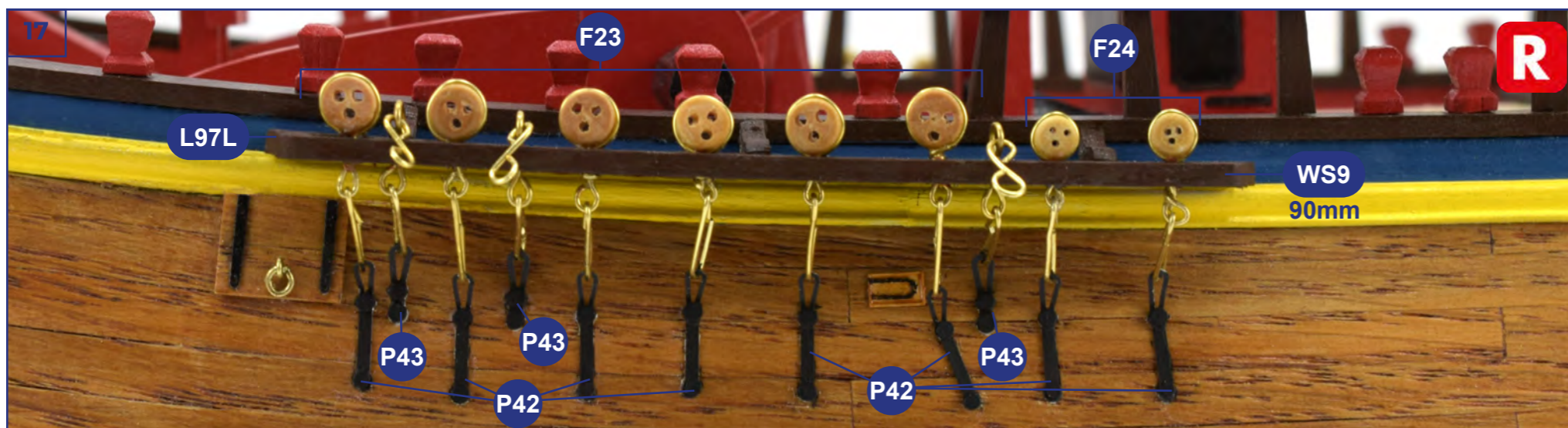
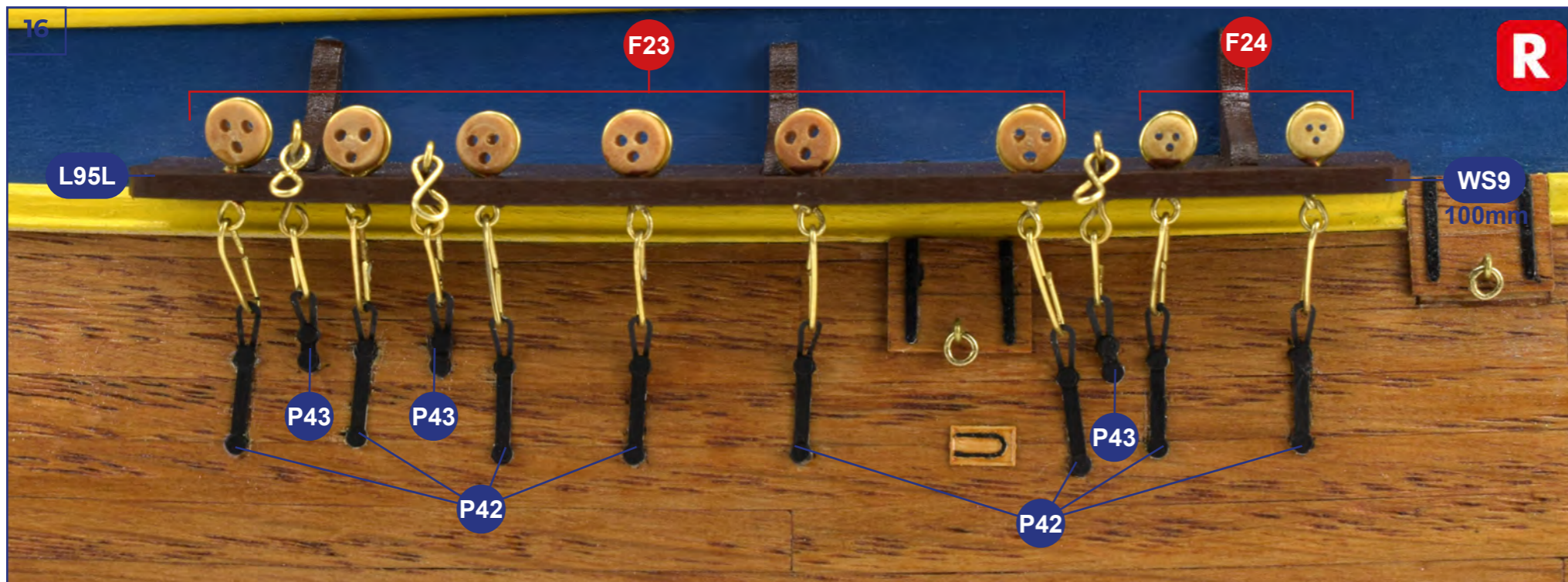
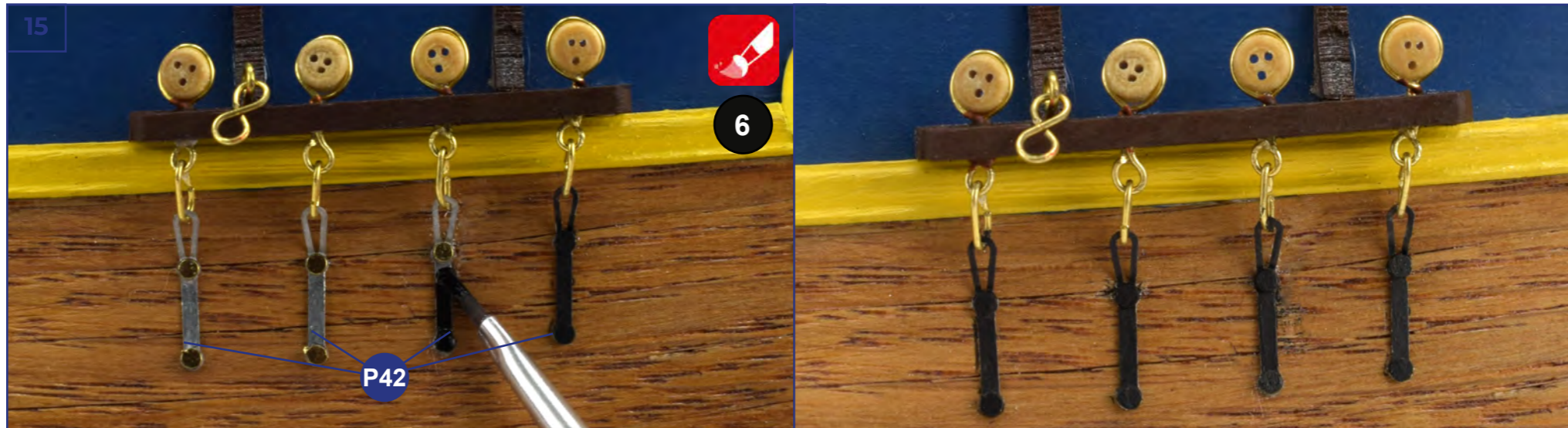

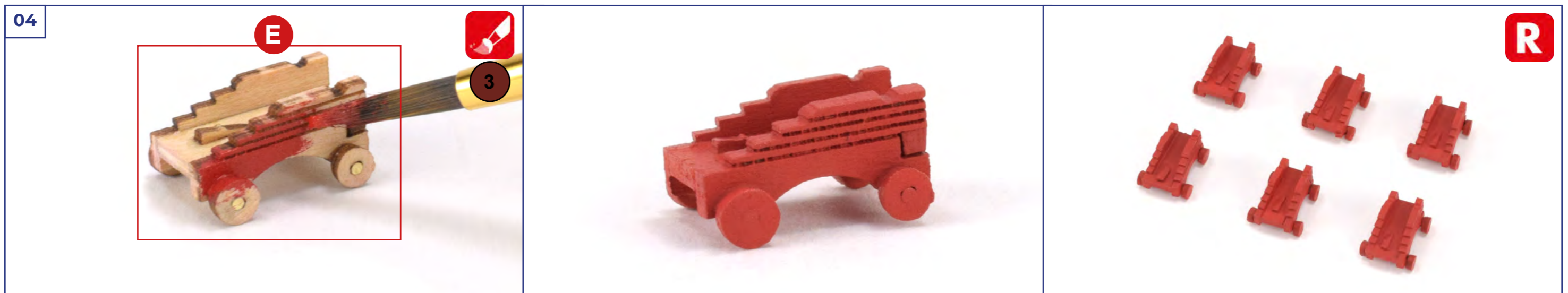
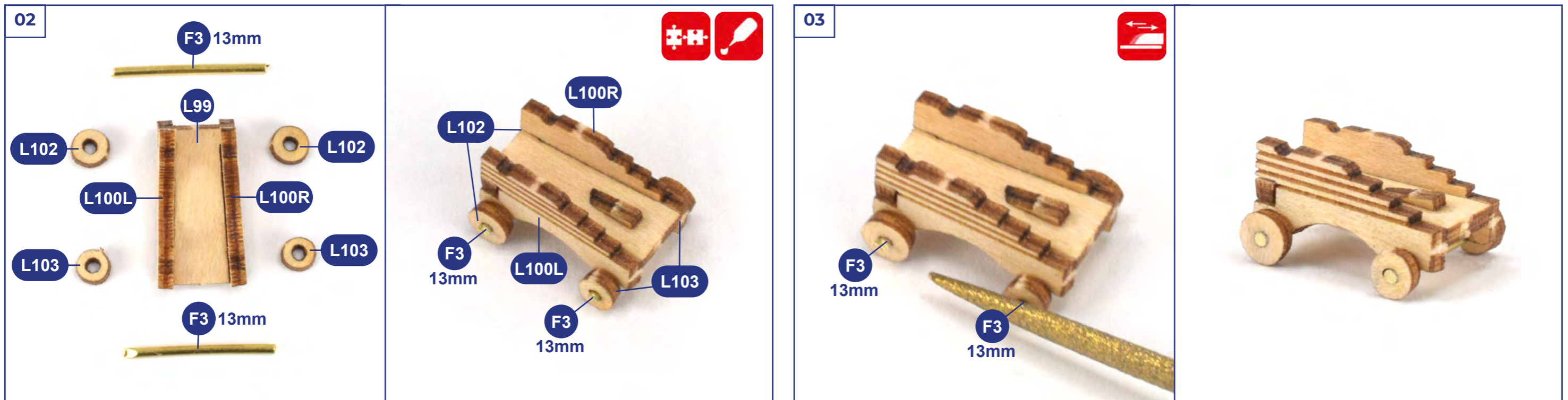
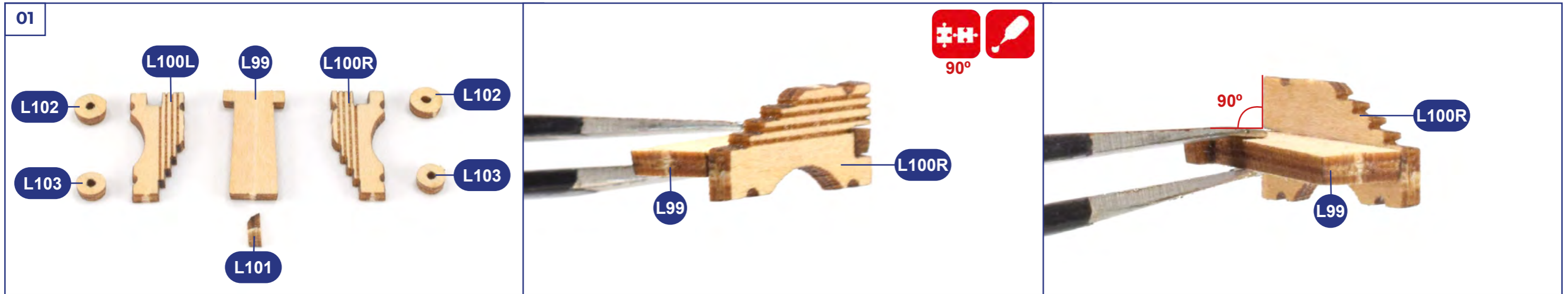

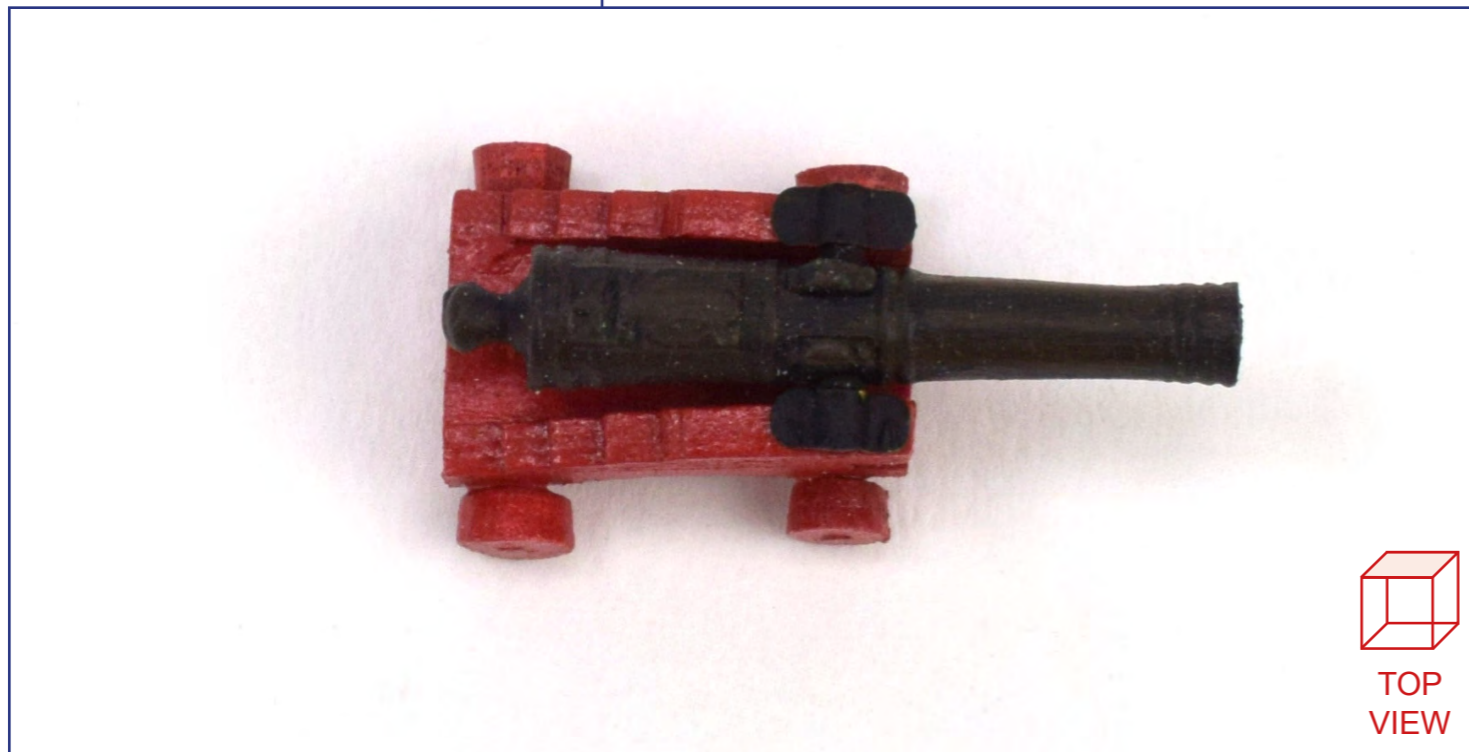
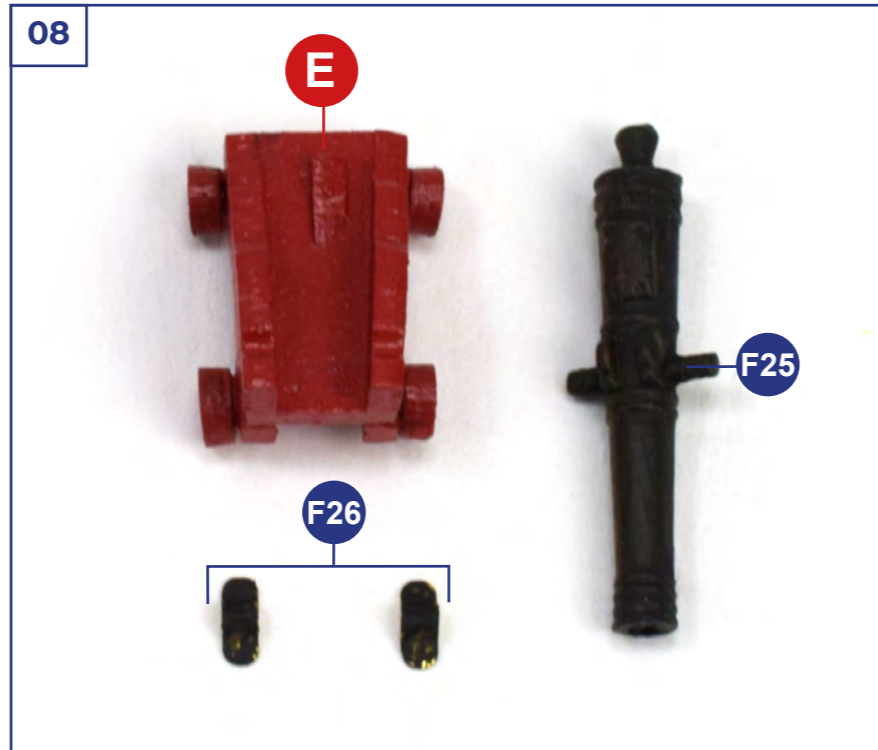
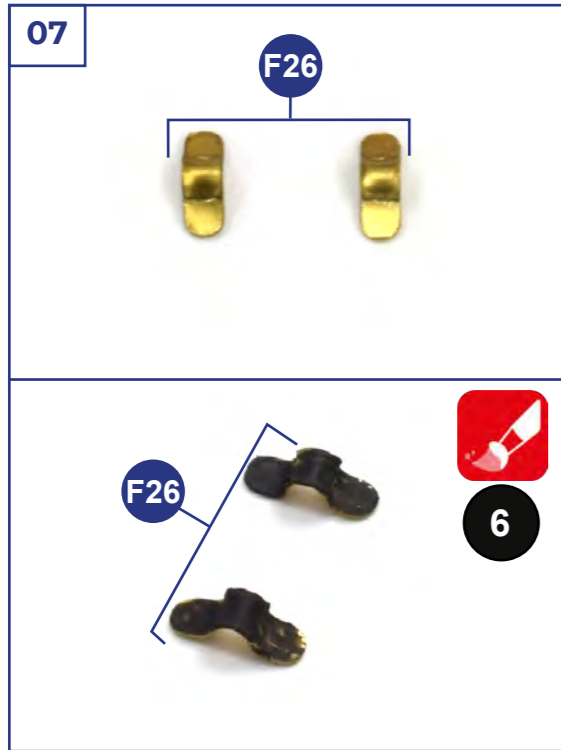
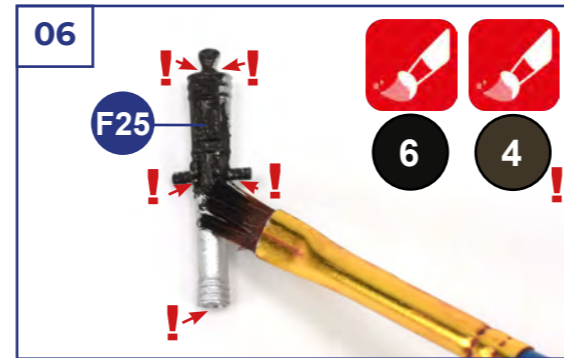
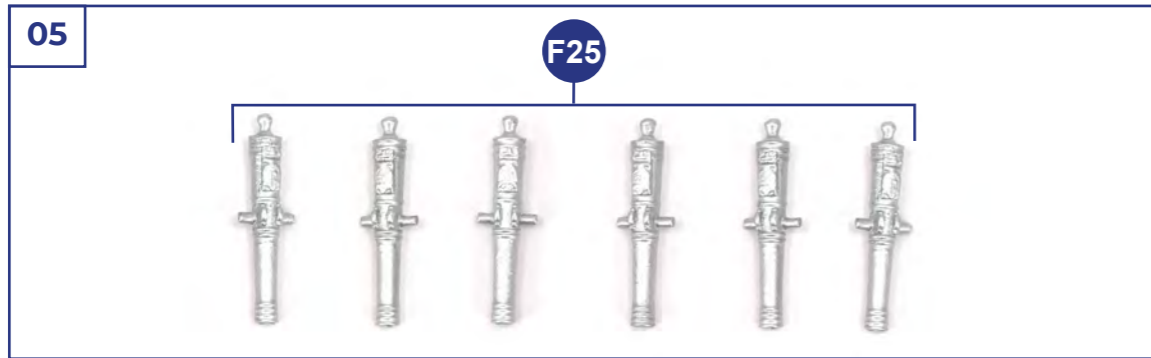

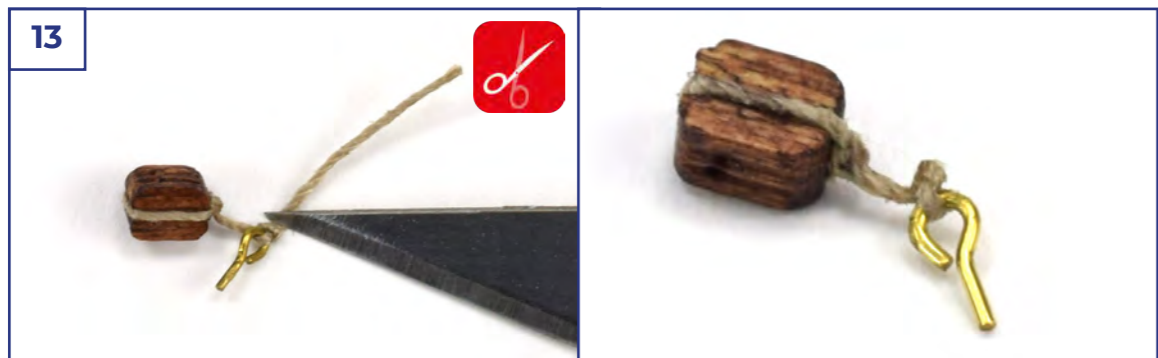
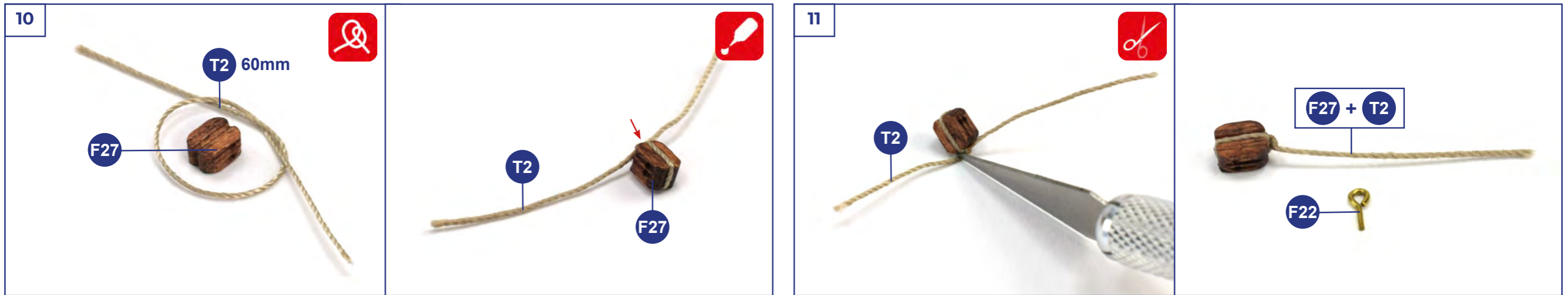
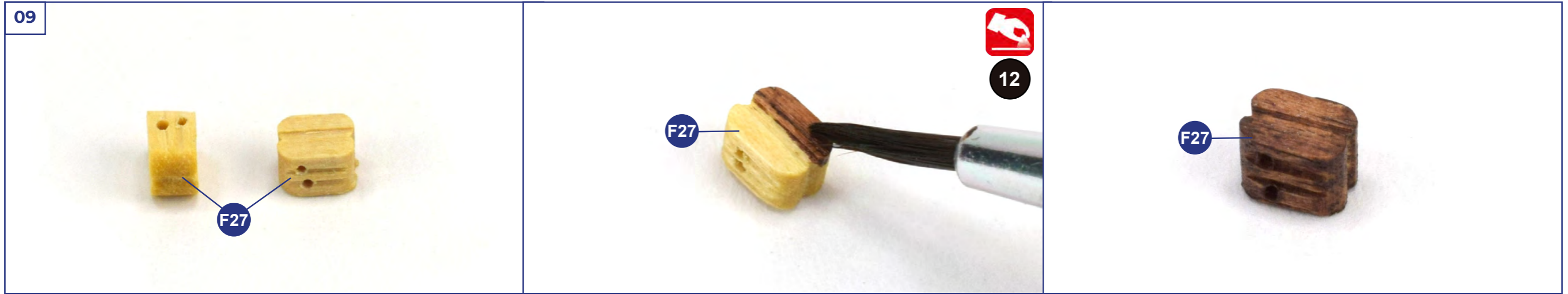



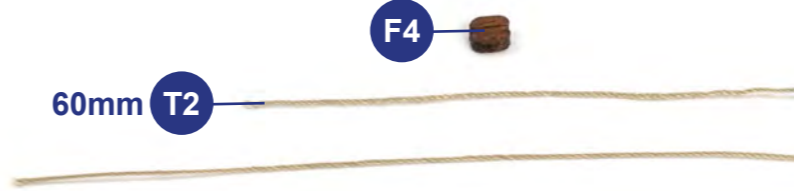



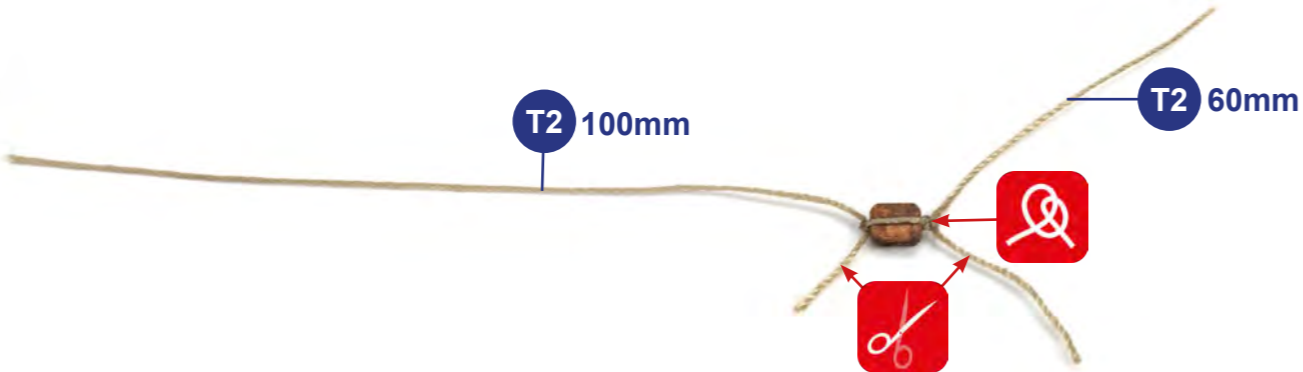

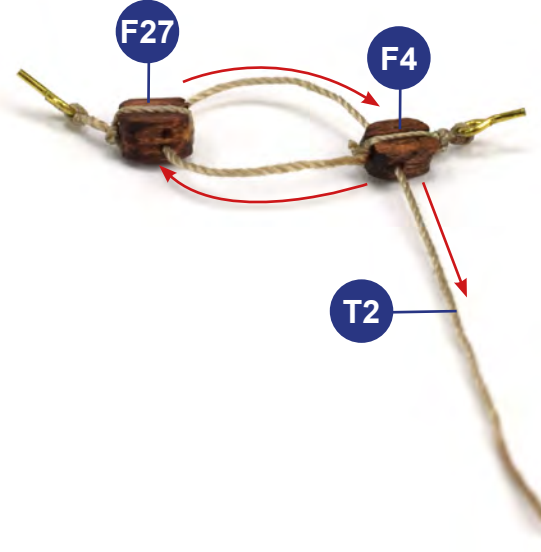
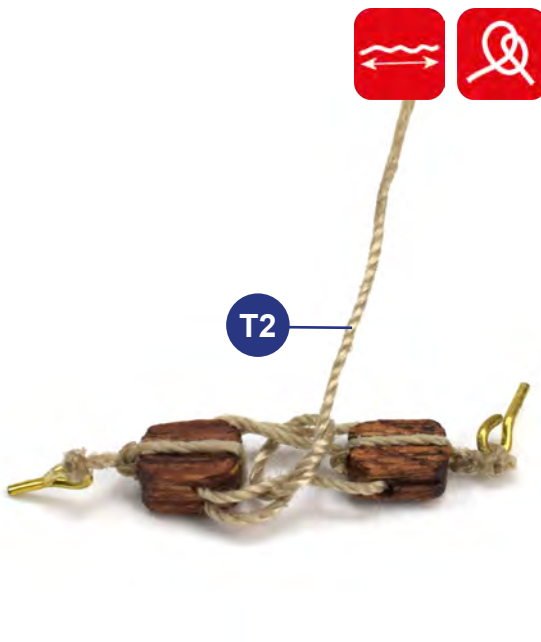



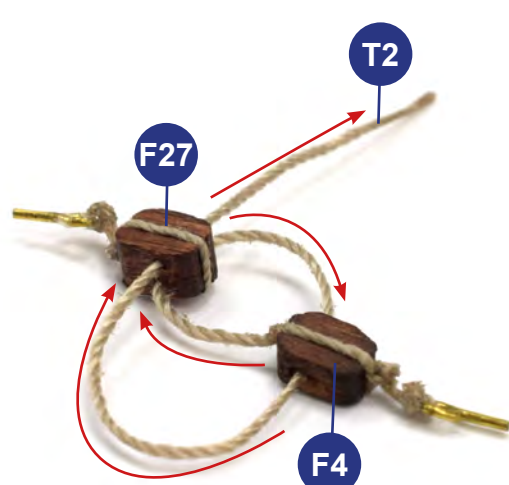





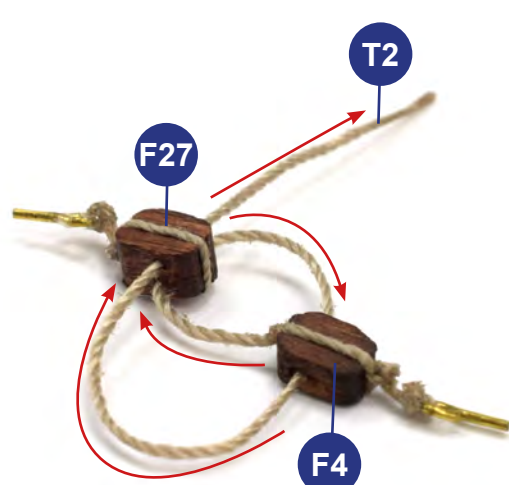

<p>15</p>  <p>F4 X12</p>	 <p>F4</p>  <p>12</p>	<p>16</p>  <p>60mm T2</p> <p>F4</p>  <p>100mm T2</p> <p>T2 100mm</p> <p>T2 60mm</p> 
---	--	---

<p>17</p>  <p>T2 100mm</p> <p>T2 60mm</p>  	 <p>F27</p> <p>F4</p> <p>T2</p>	   <p>T2</p>
 <p>F22</p> <p>T2</p> 	 <p>T2</p> <p>F27</p> <p>F4</p>   	  

<p>18</p>  <p>F27 + T2 + F22</p> <p>F4 + T2 + F22</p>	 <p>T2</p> <p>F27</p> <p>F4</p>	 <p>F</p> <p>R</p> <p>X12</p>
---	--	--

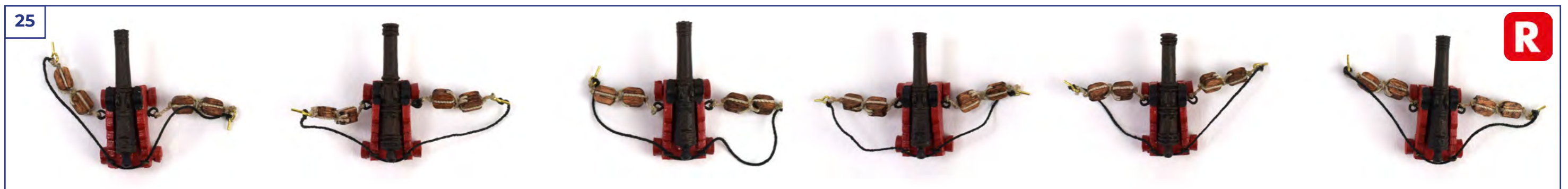
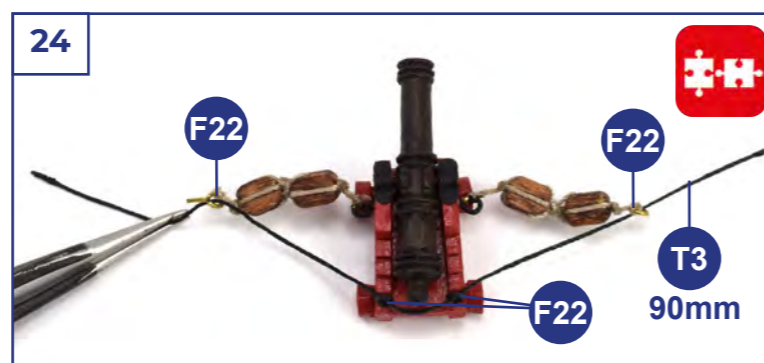
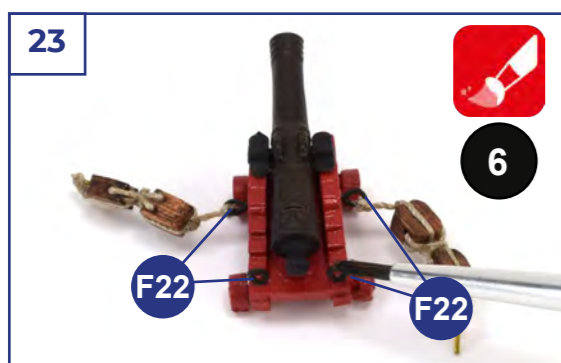
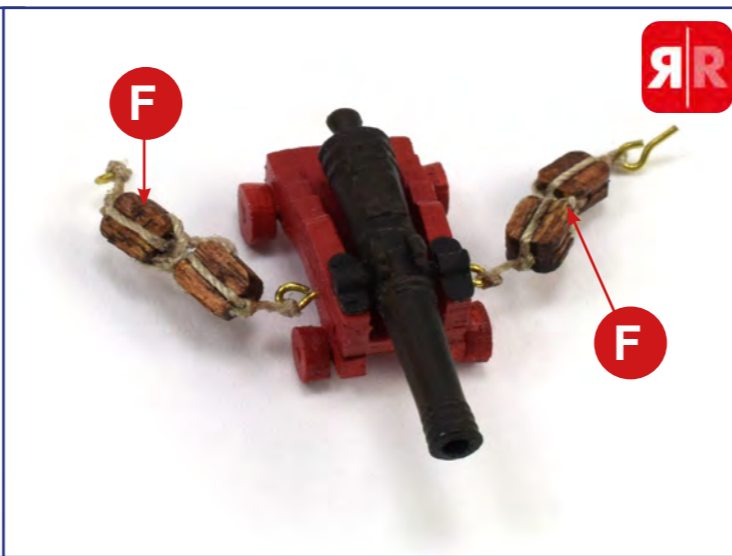
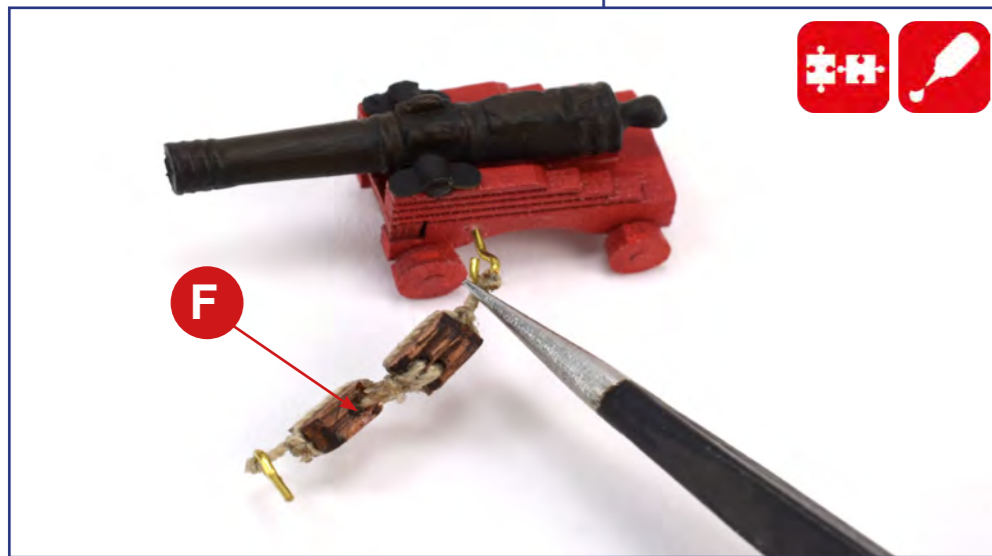
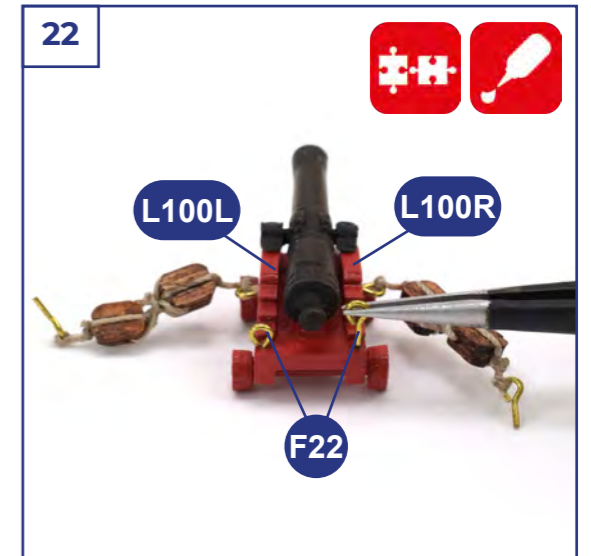
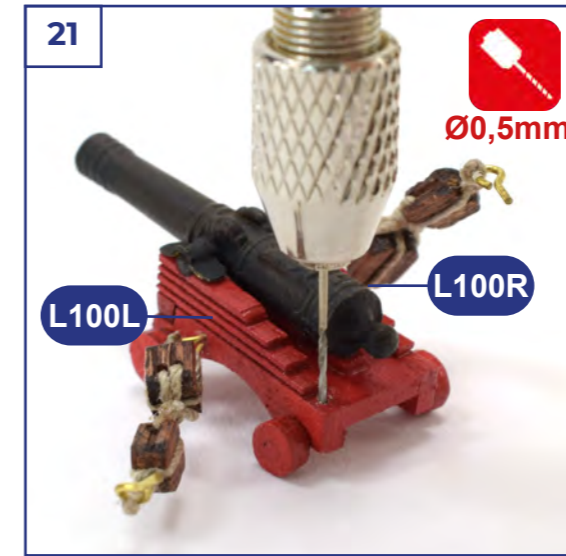
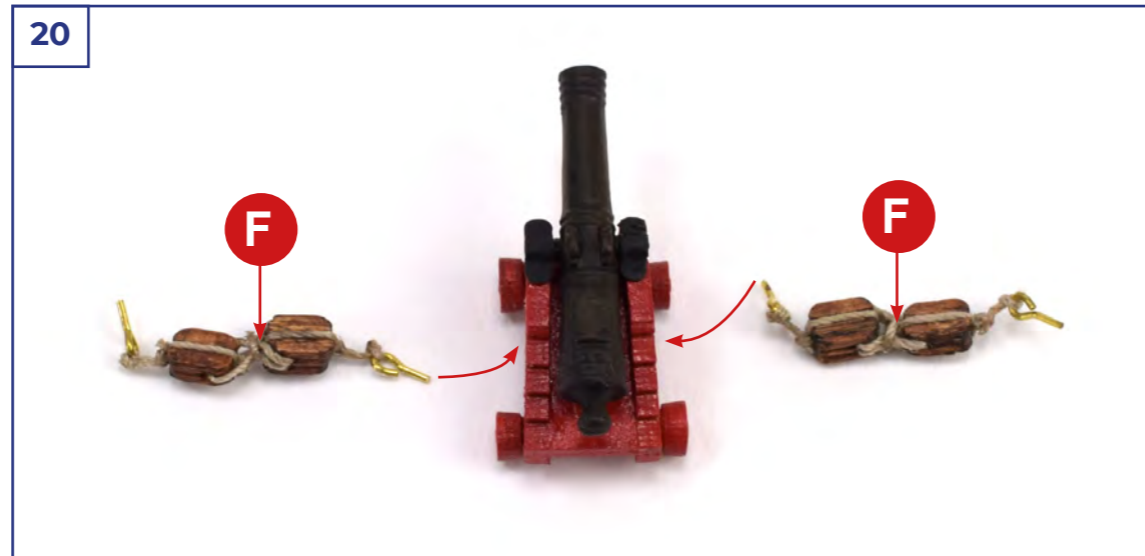

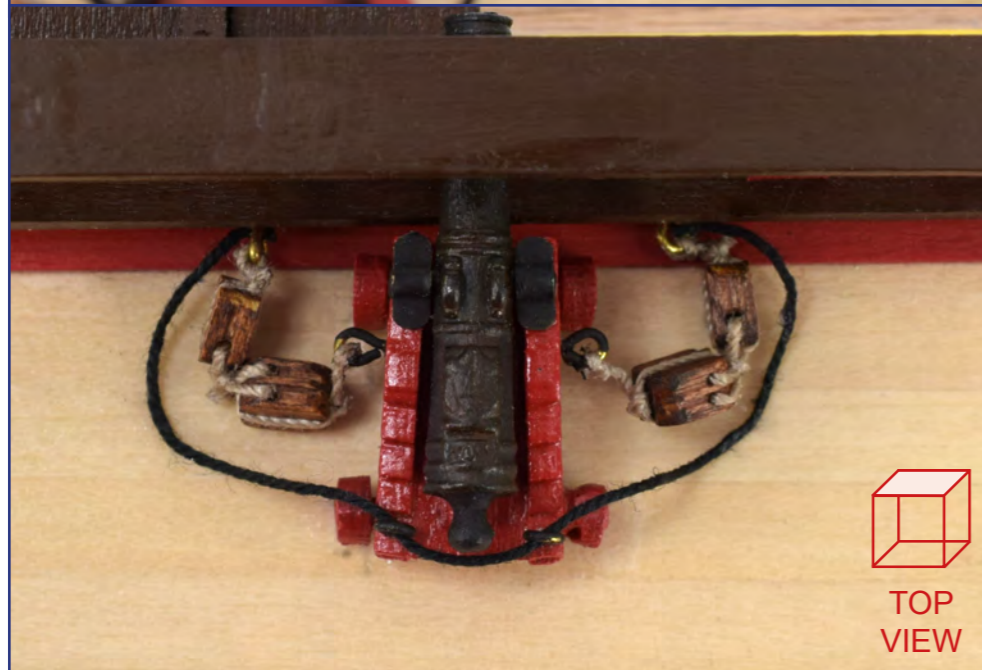
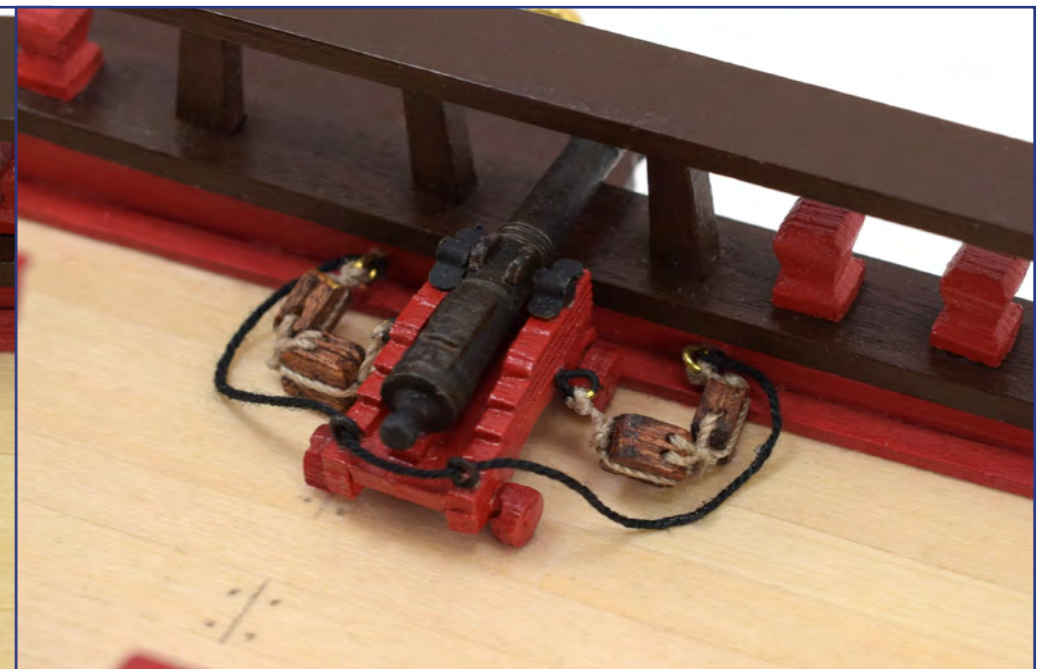
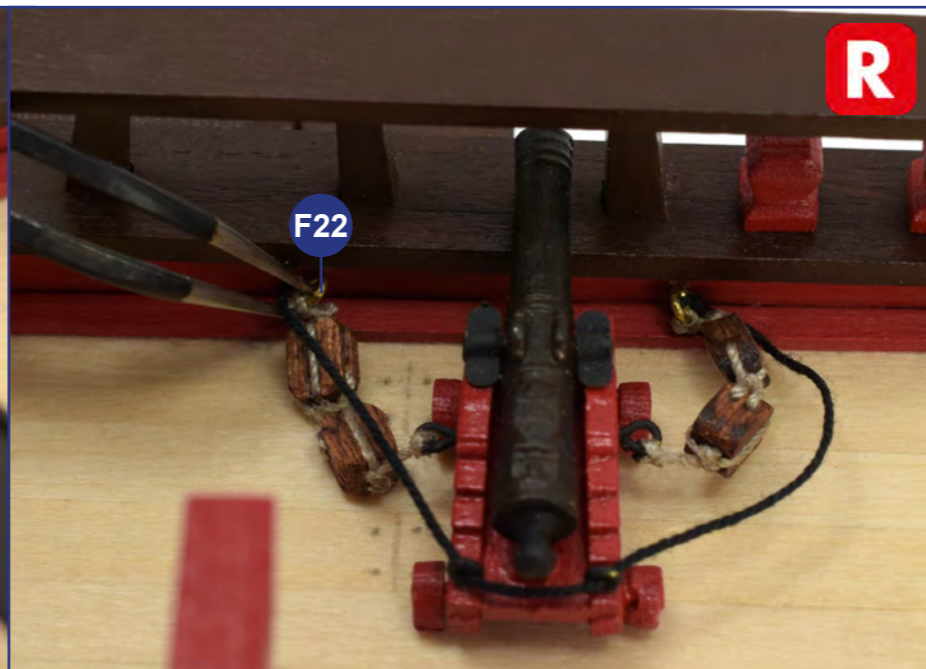
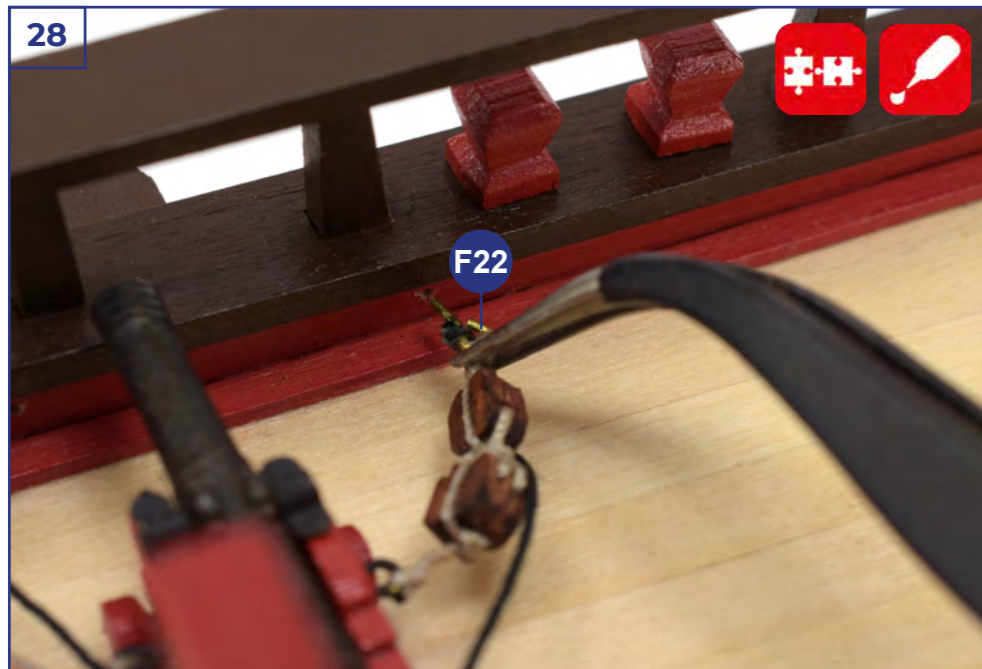
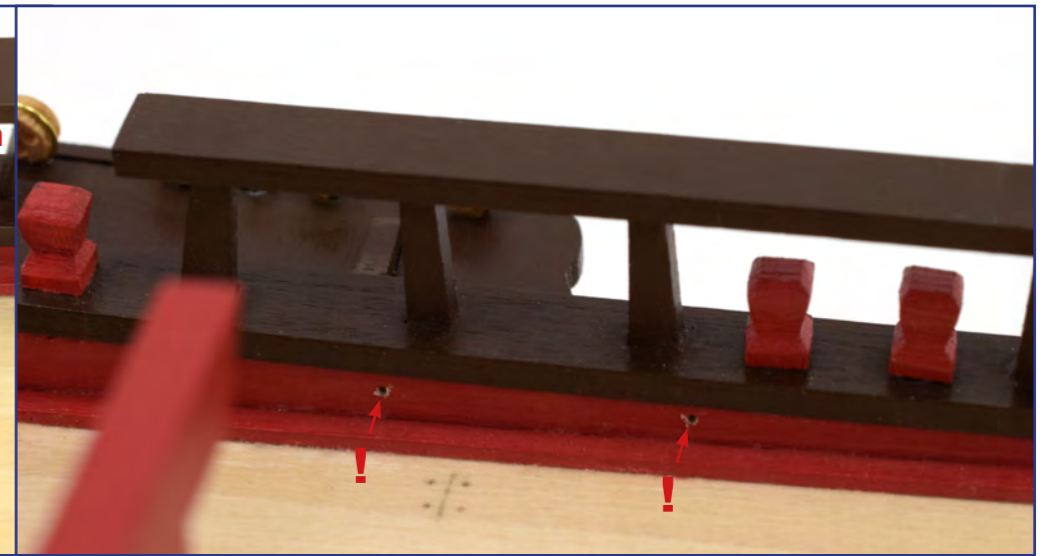
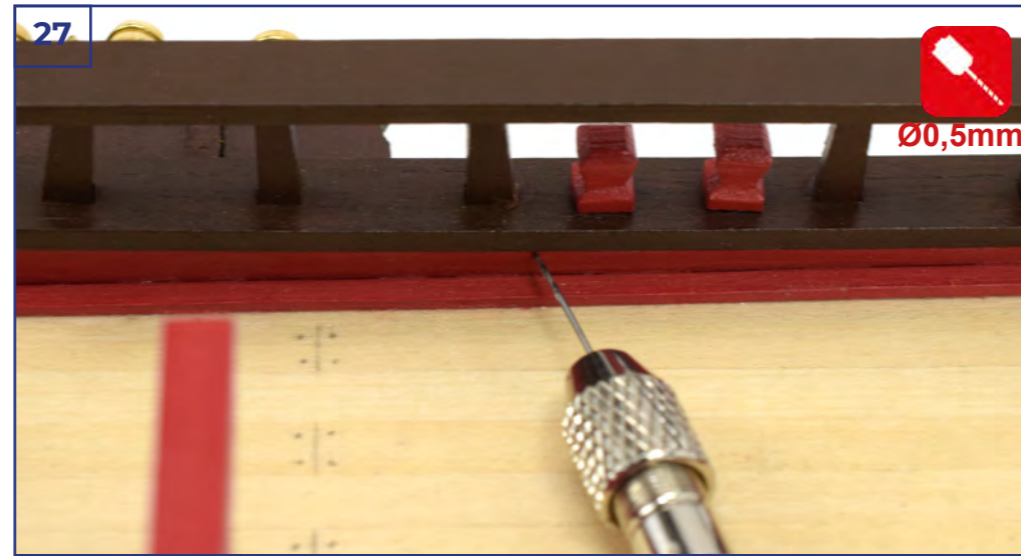
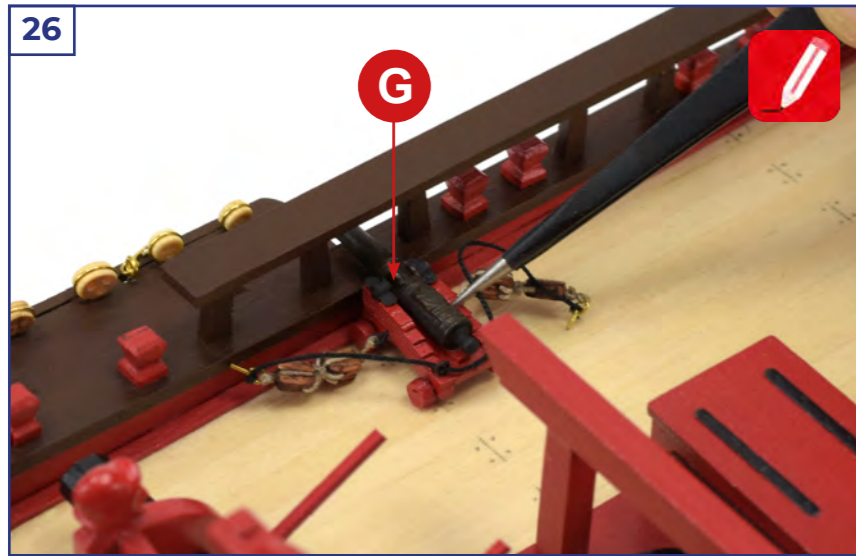

29

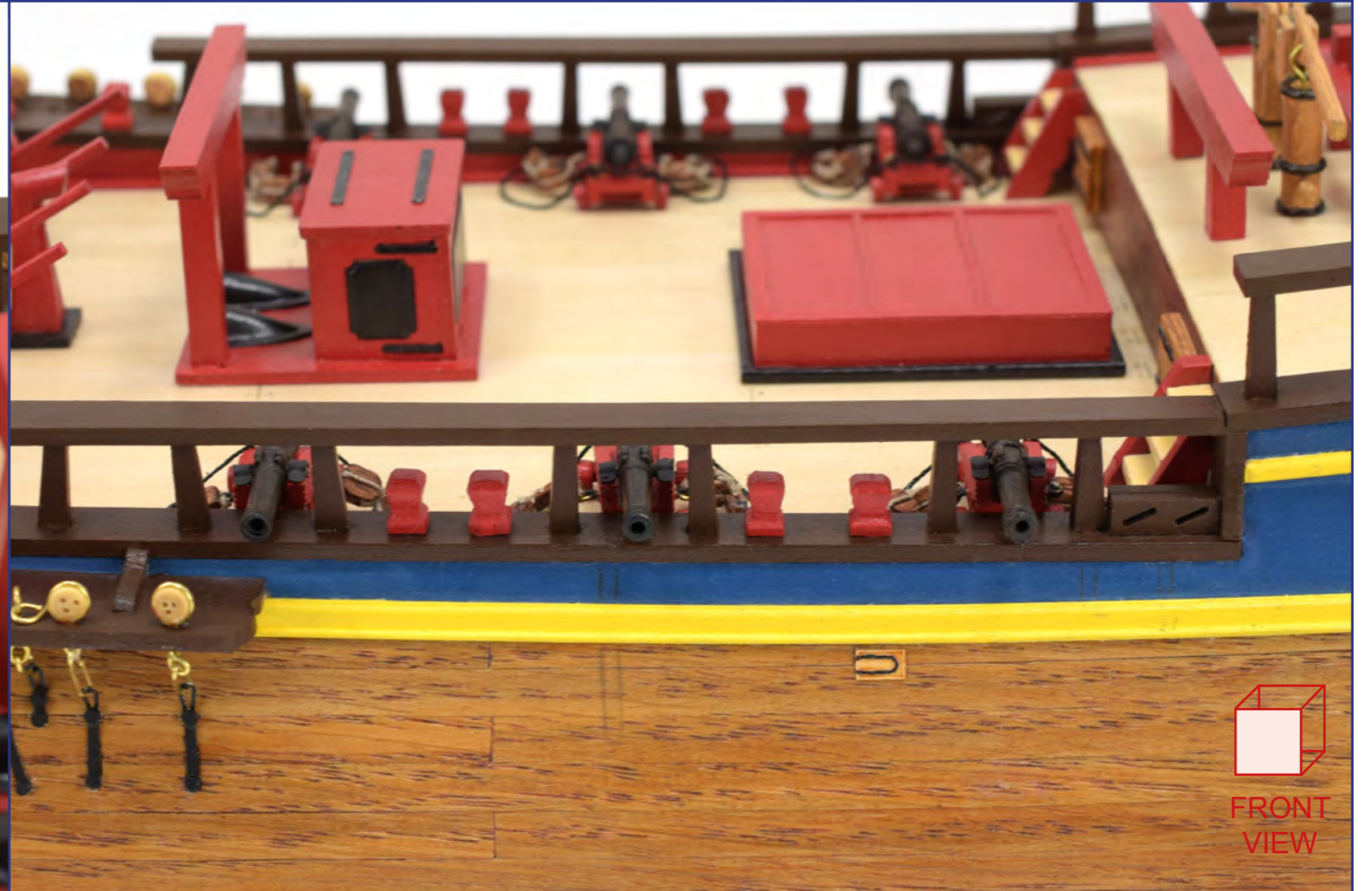
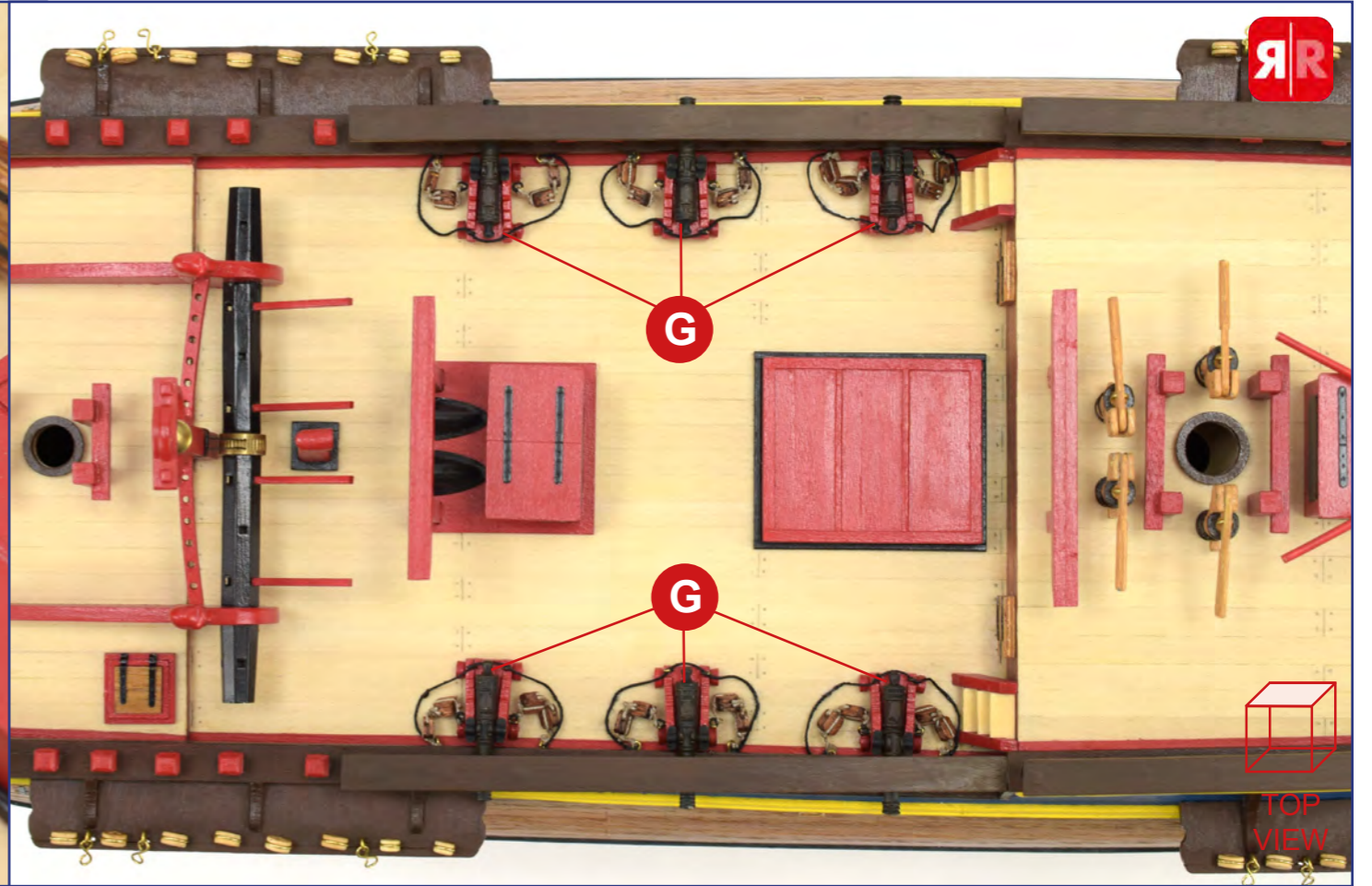
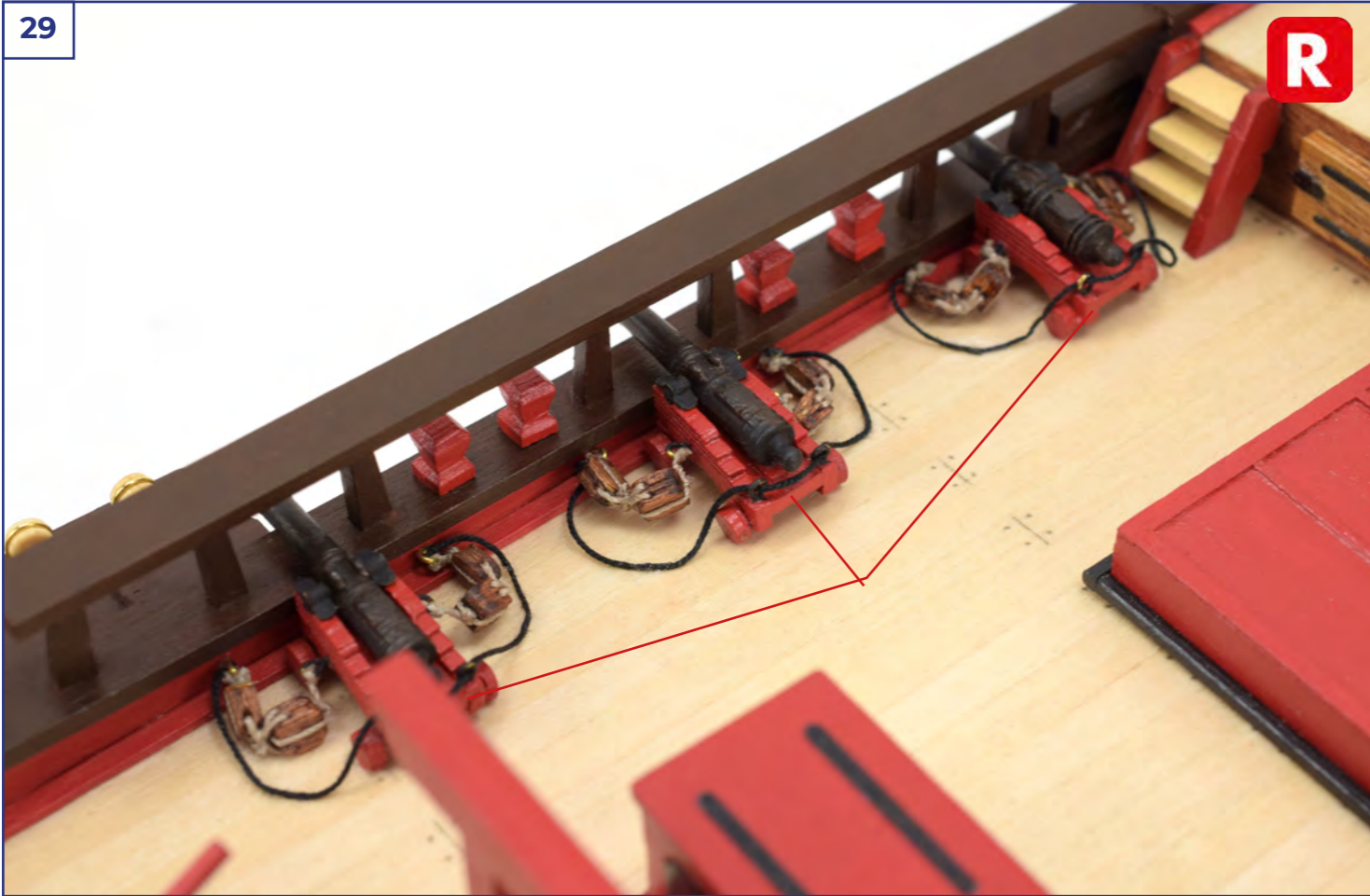

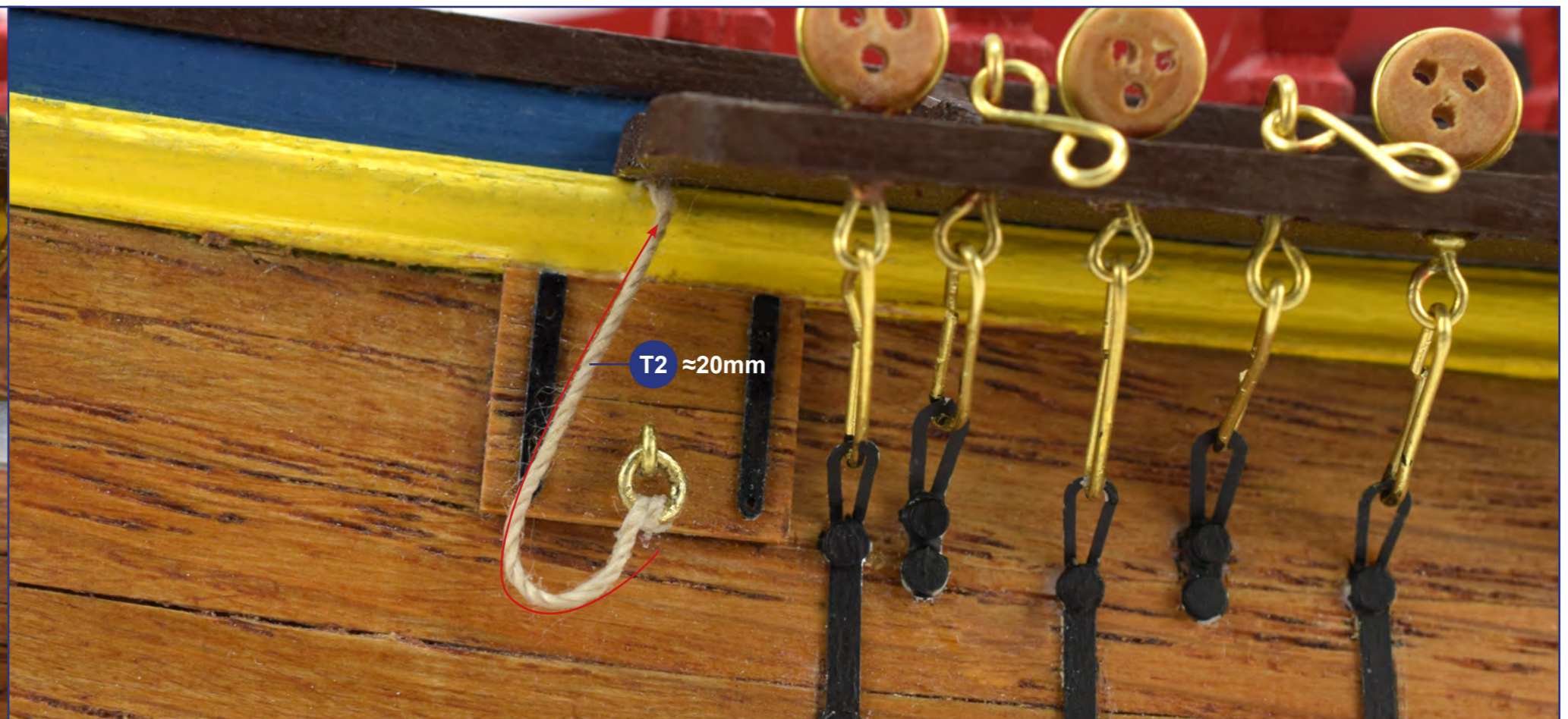
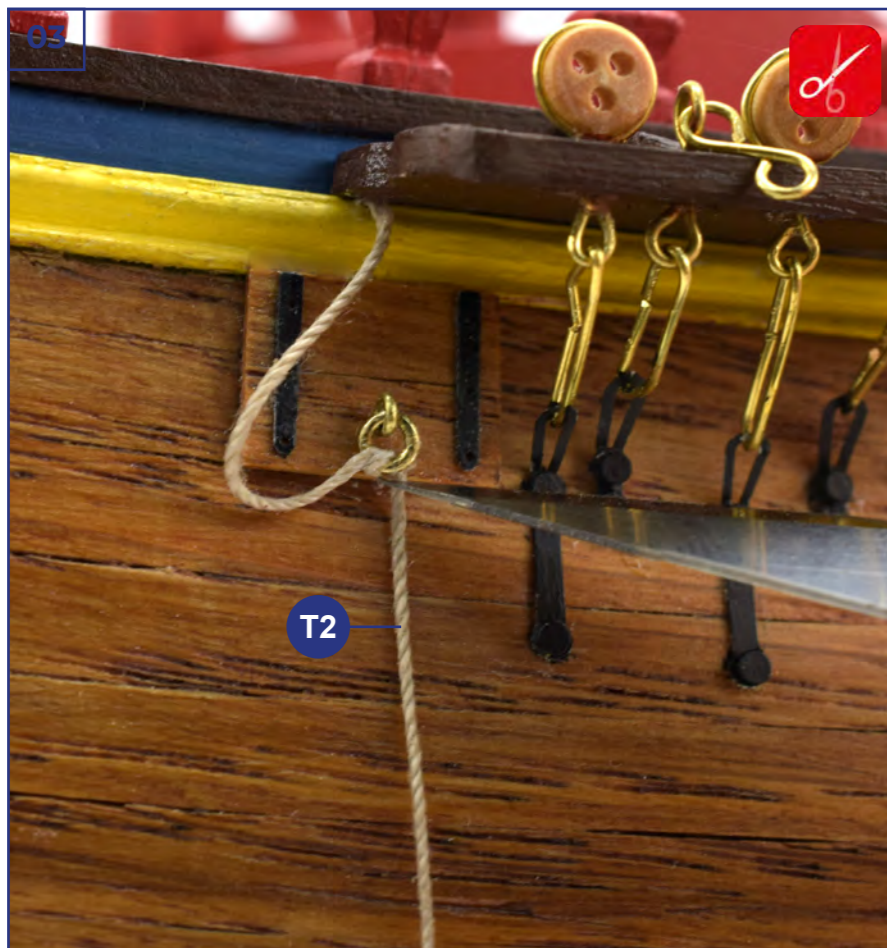
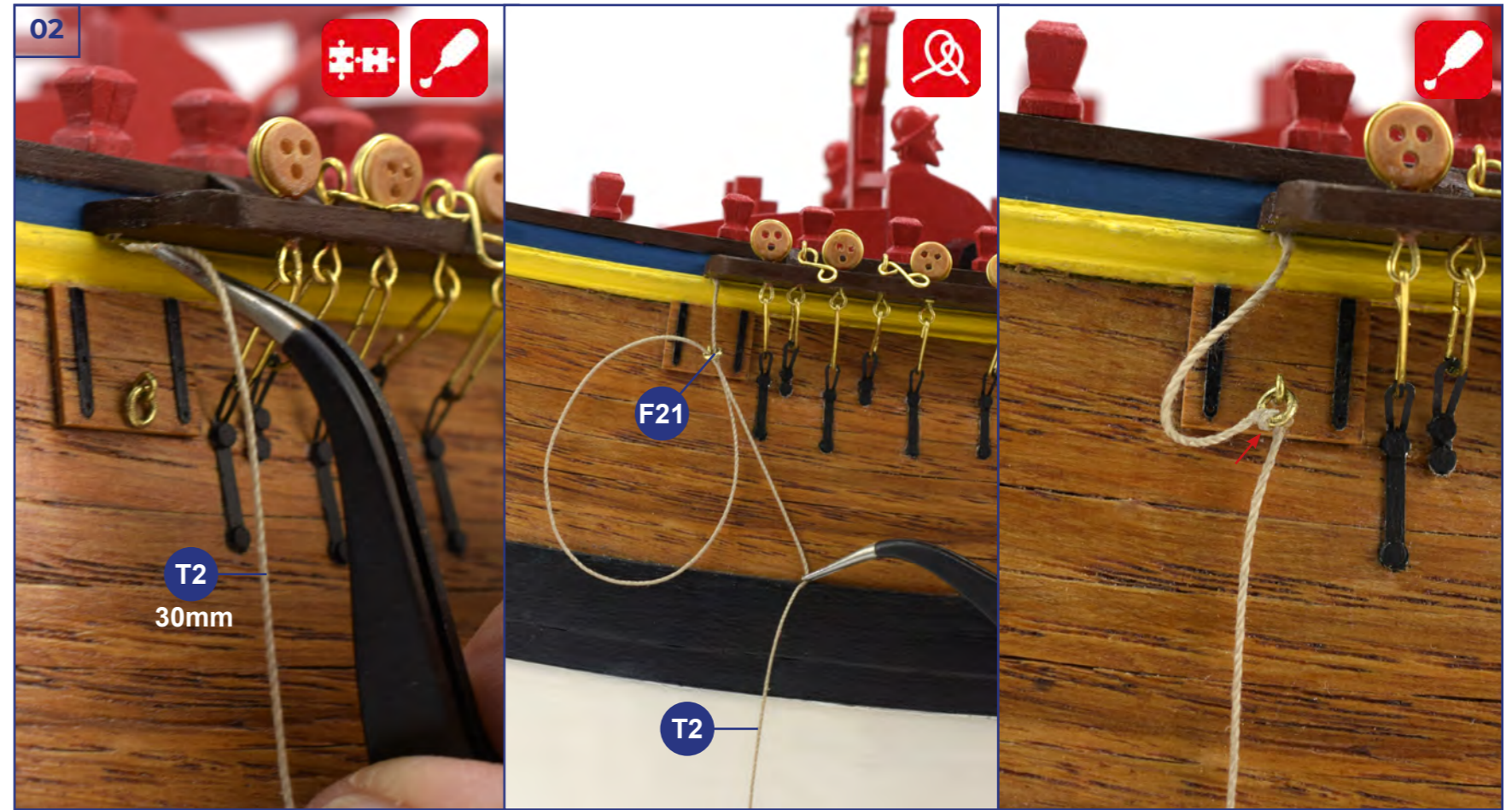
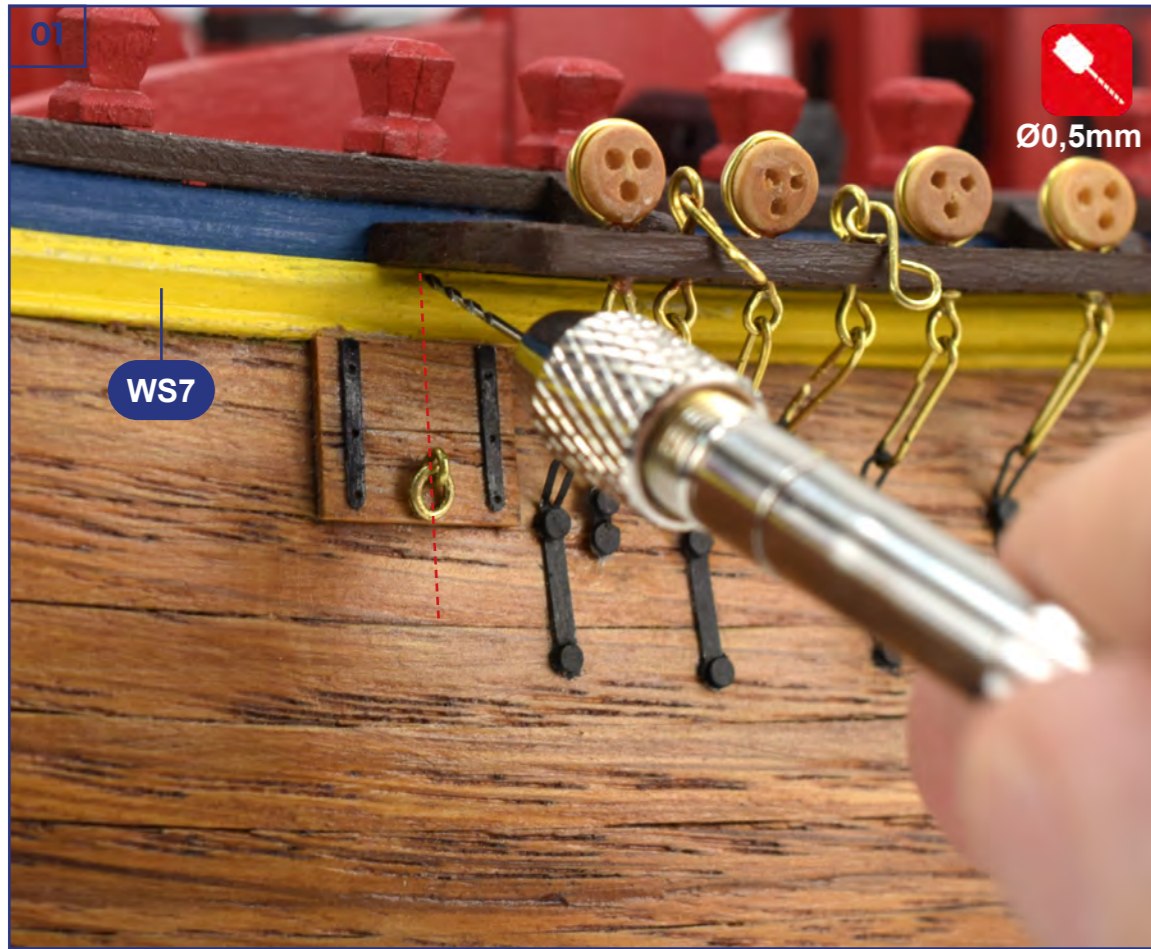

07

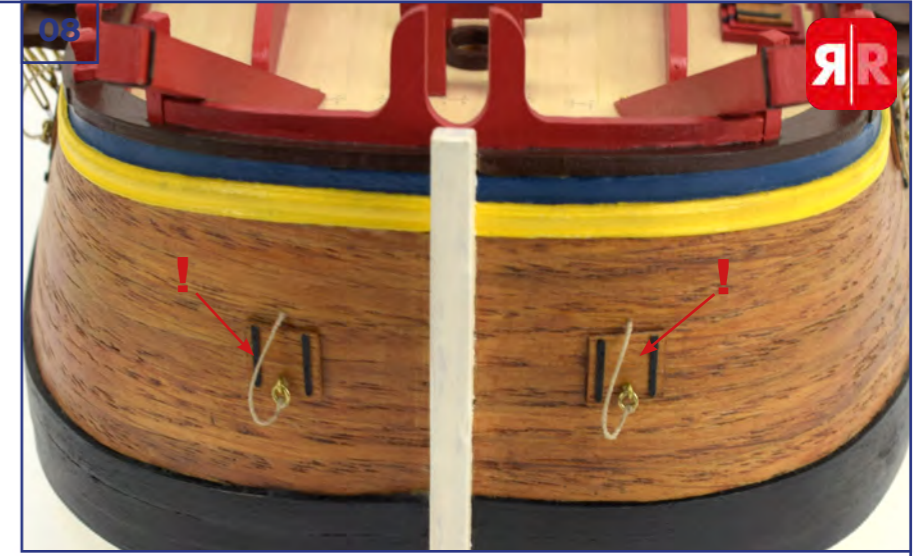

09

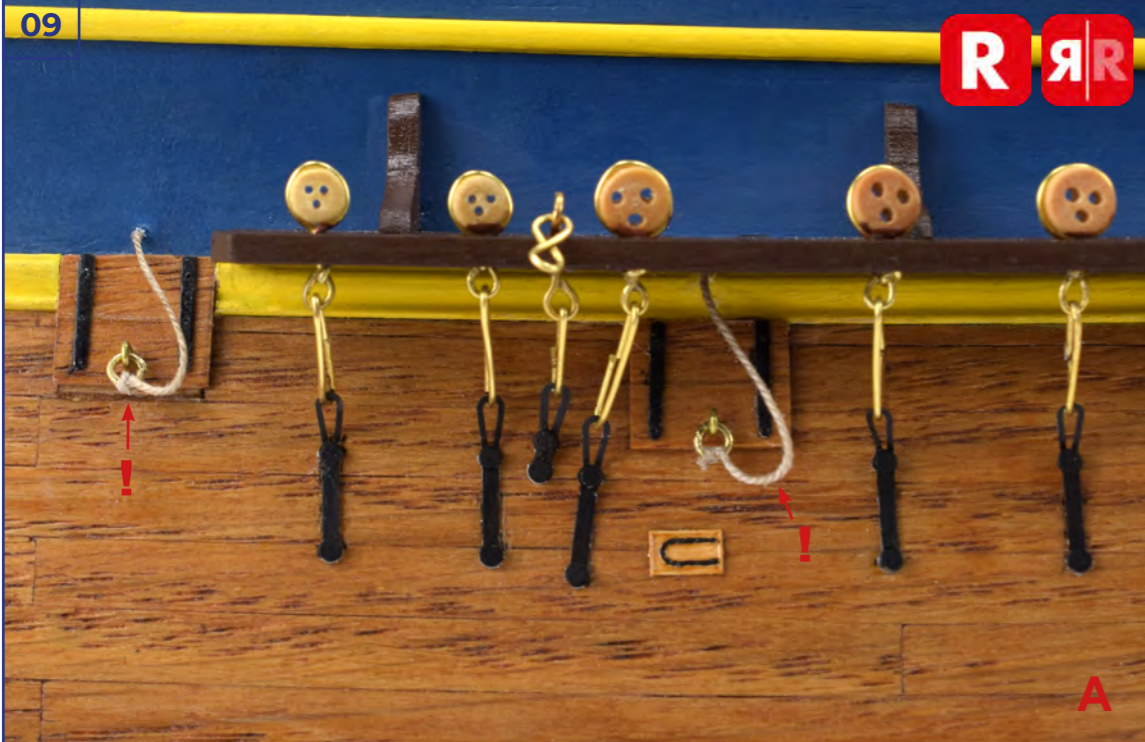

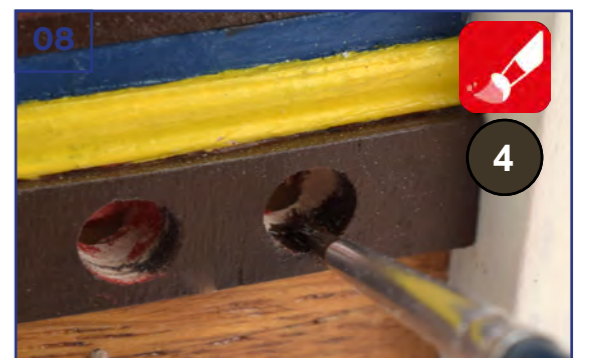
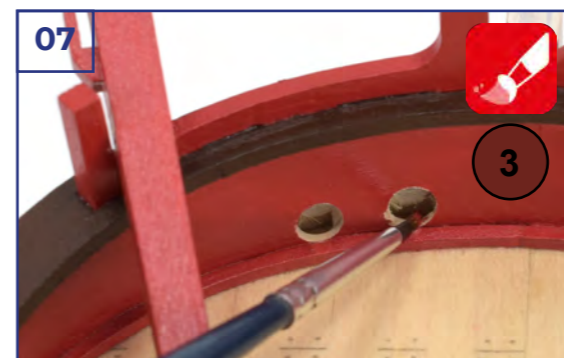
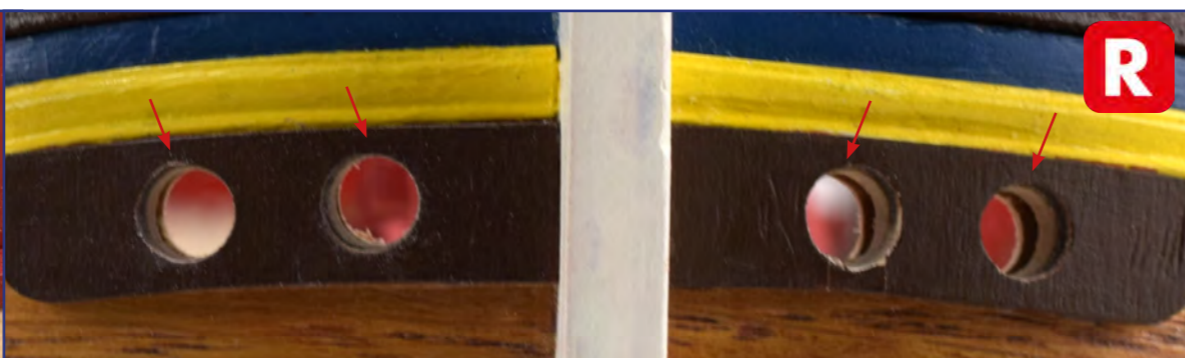
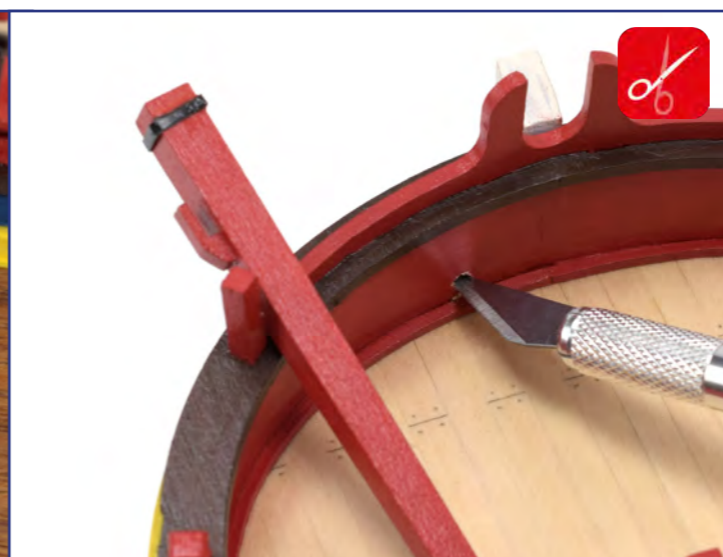
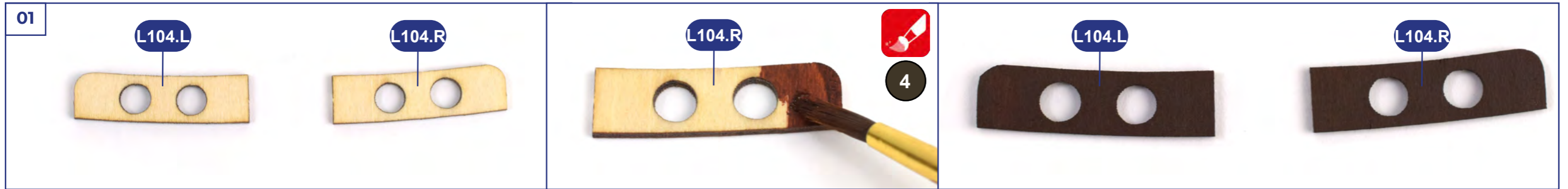

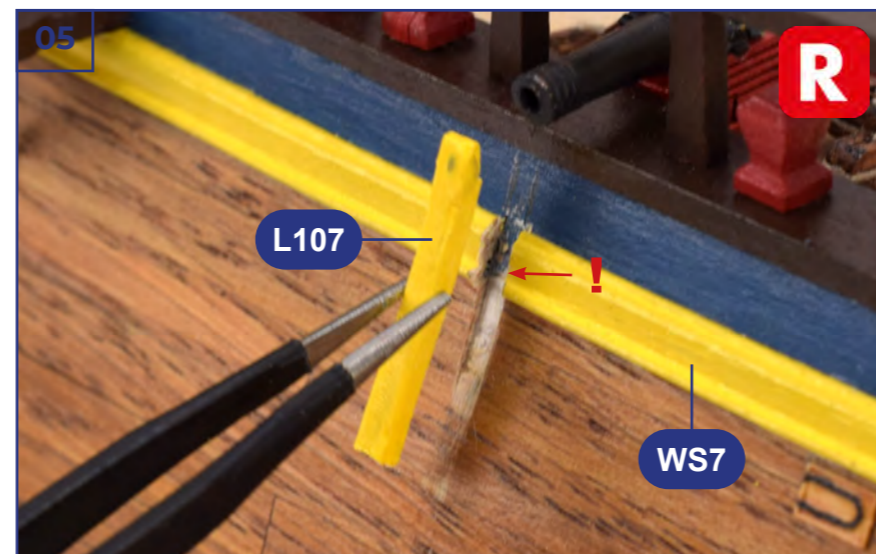
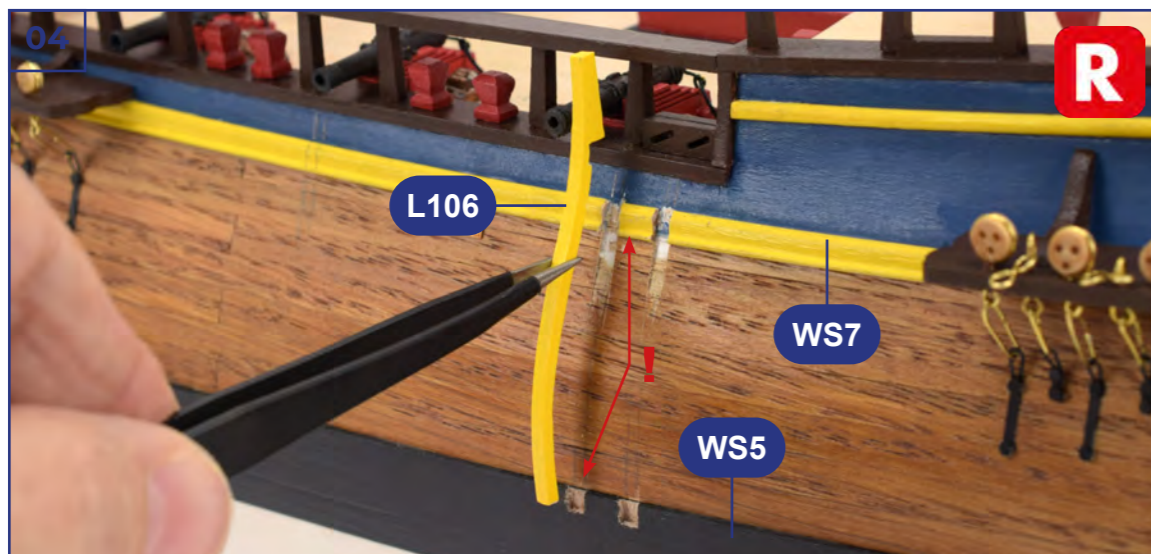
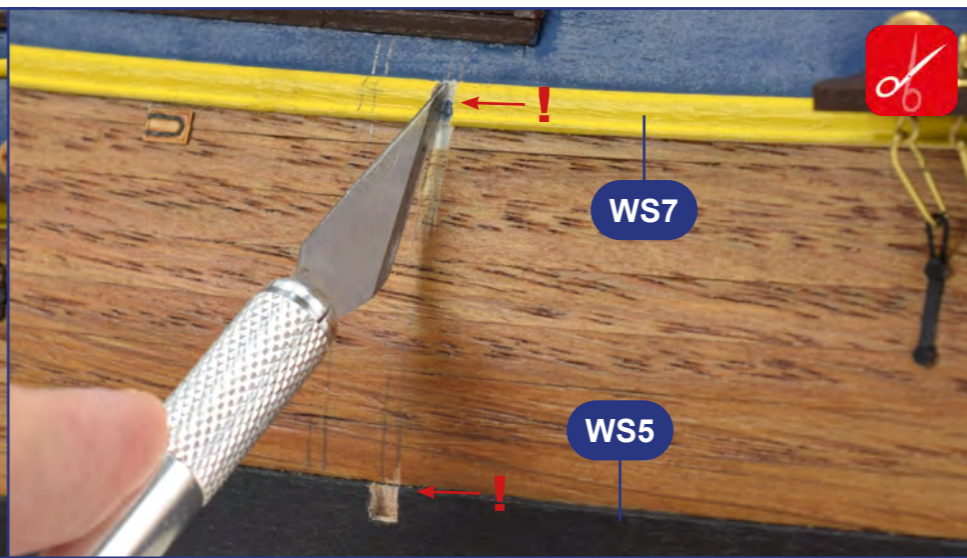
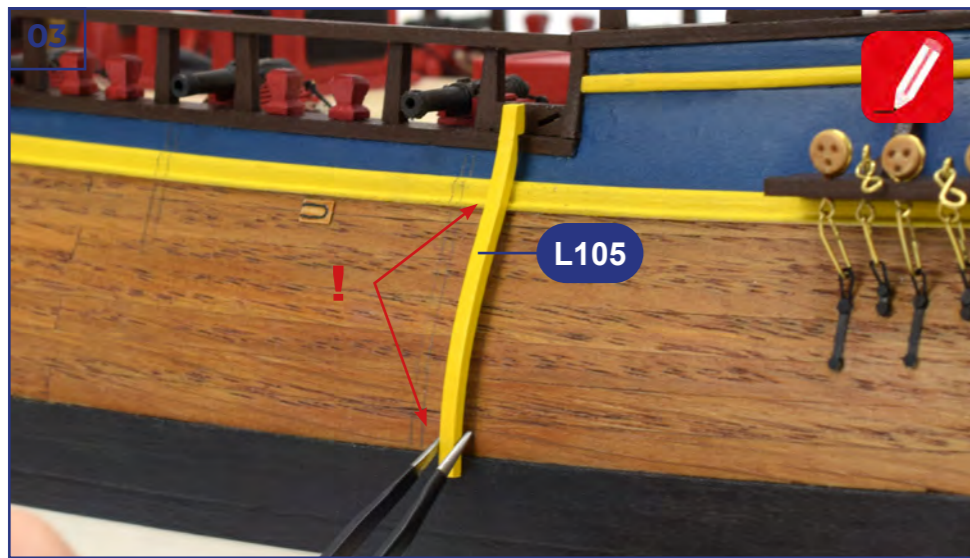
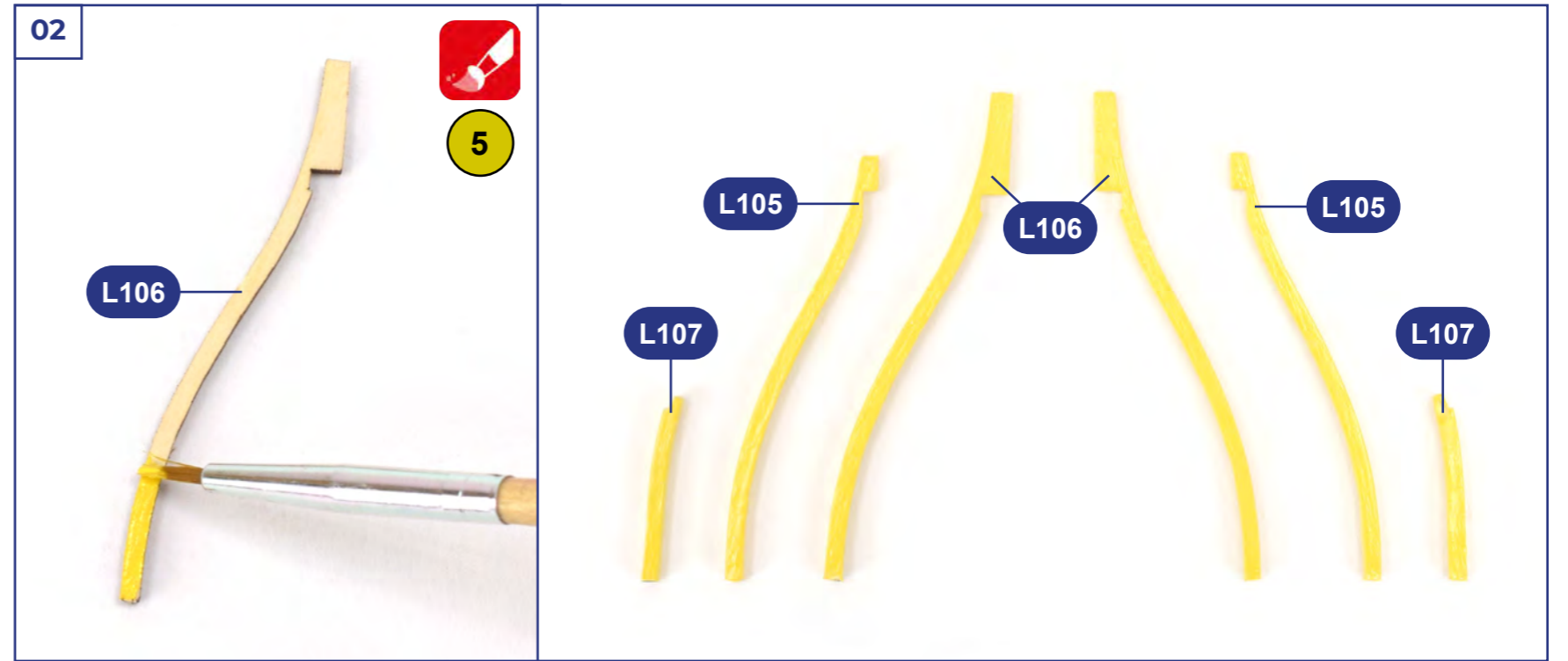
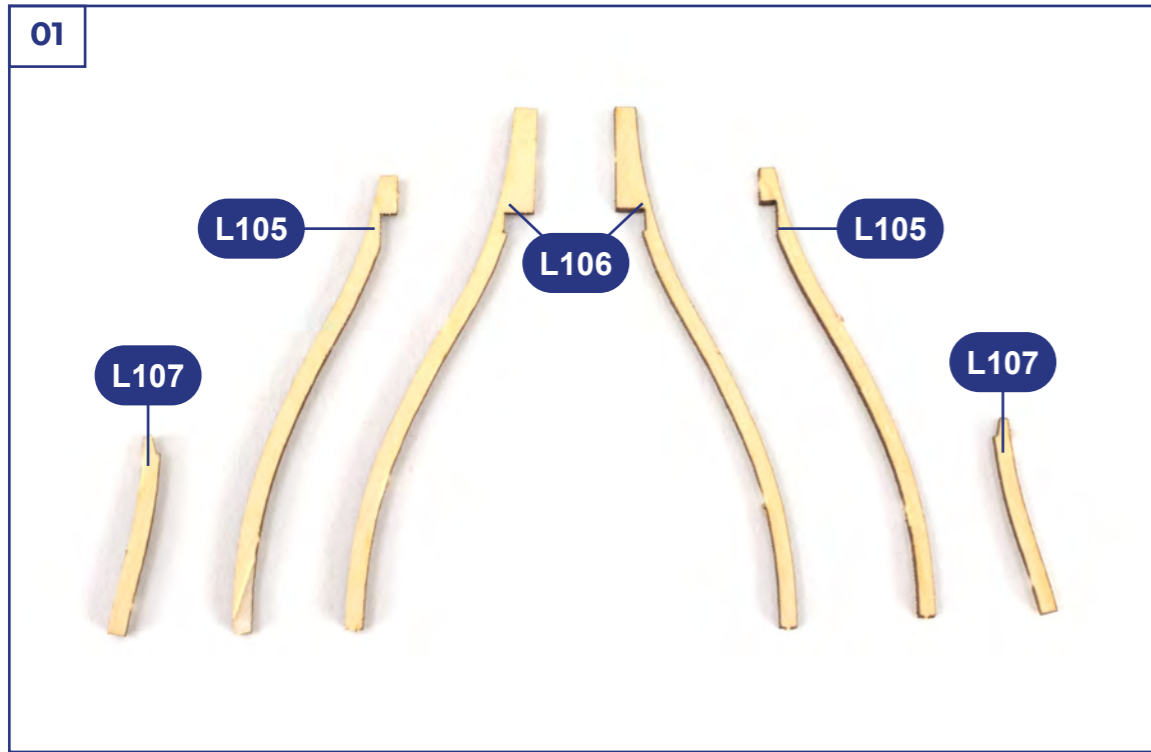

06



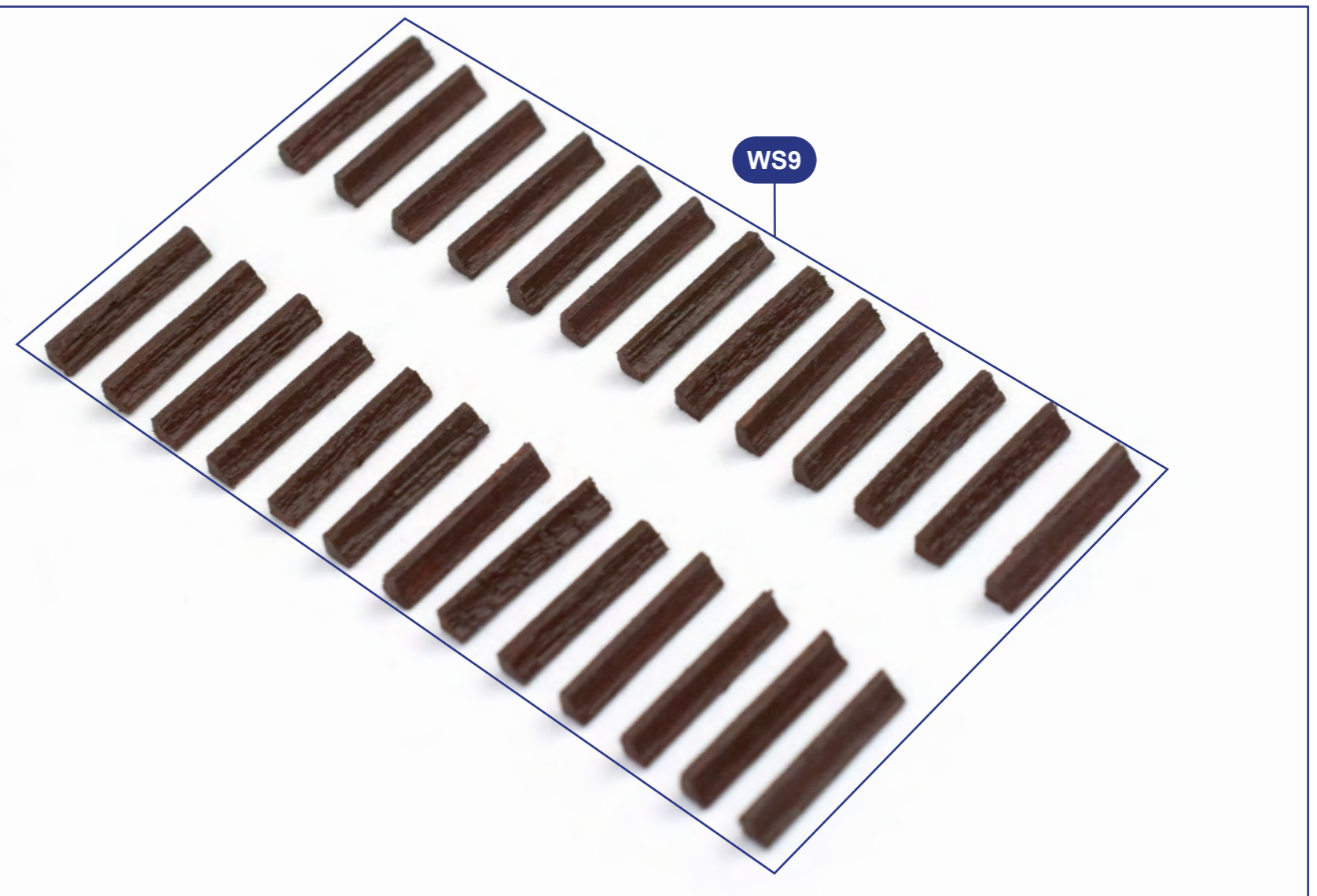
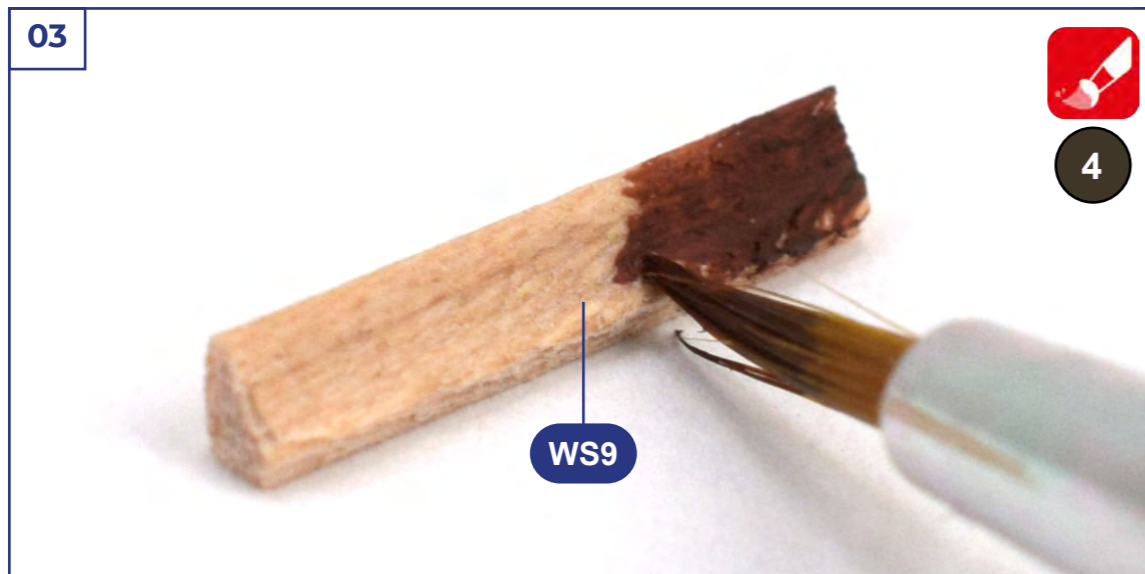
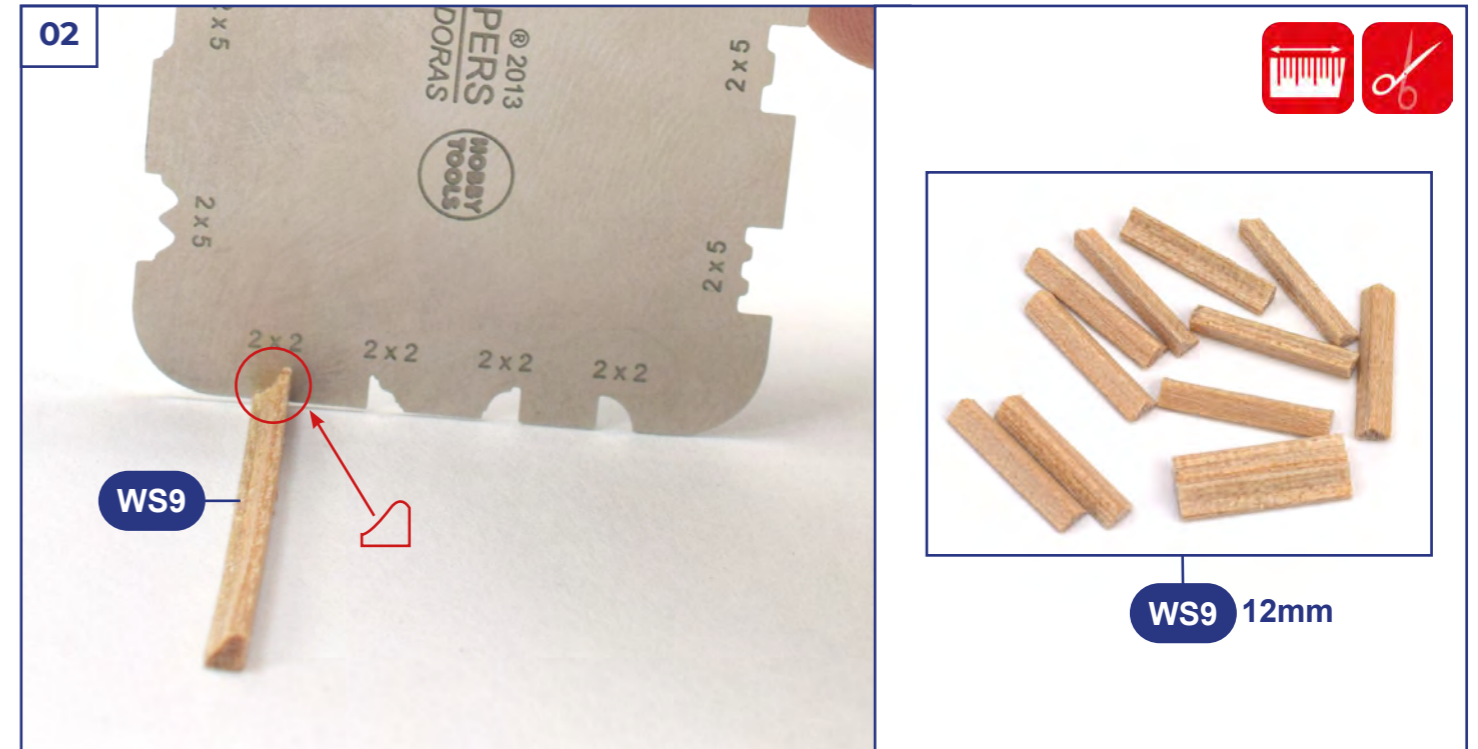

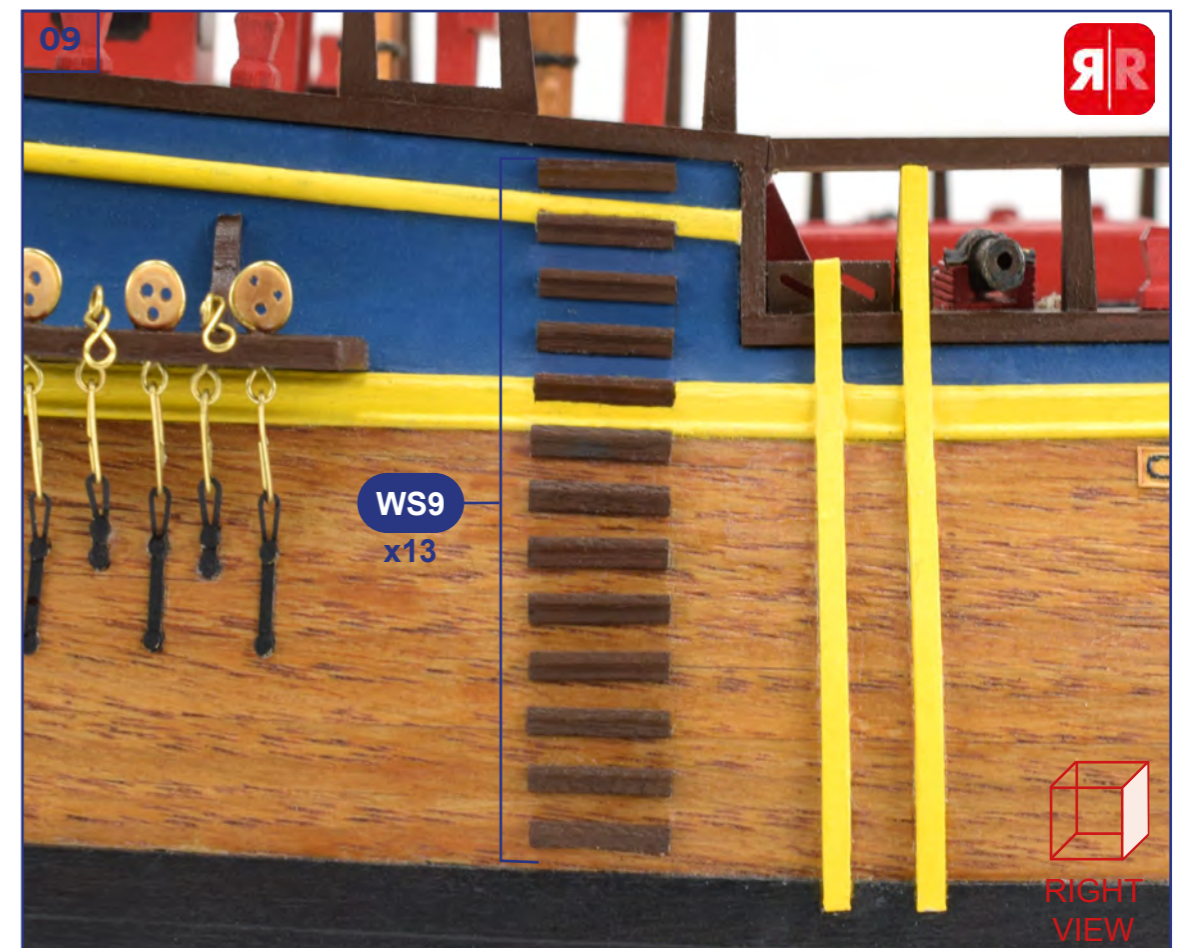
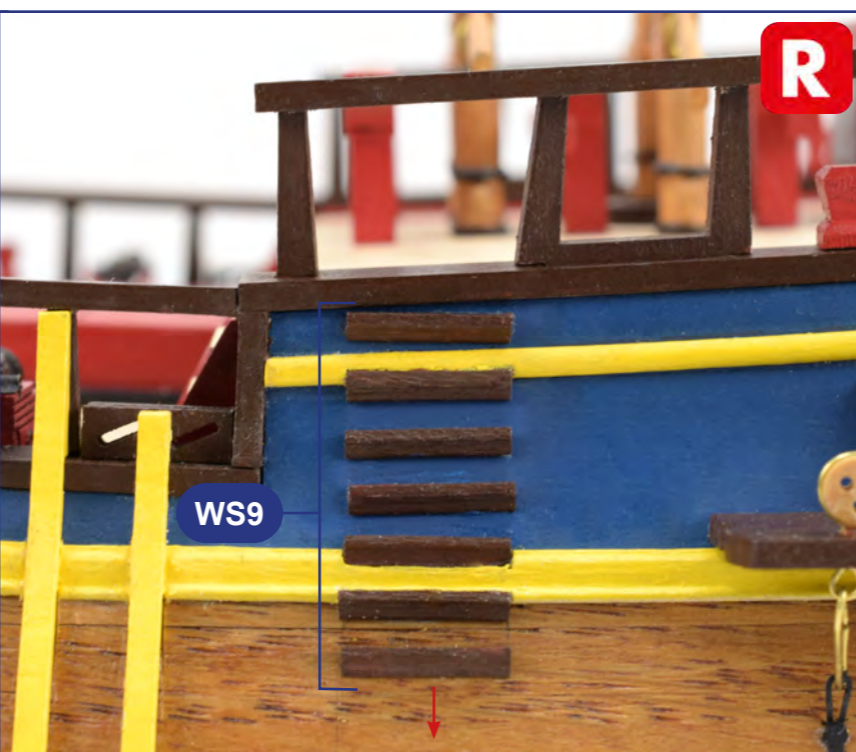
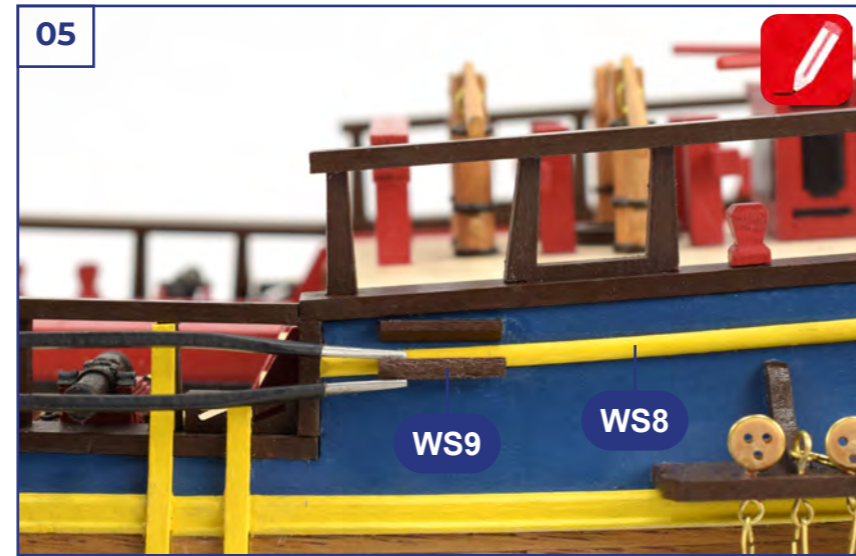
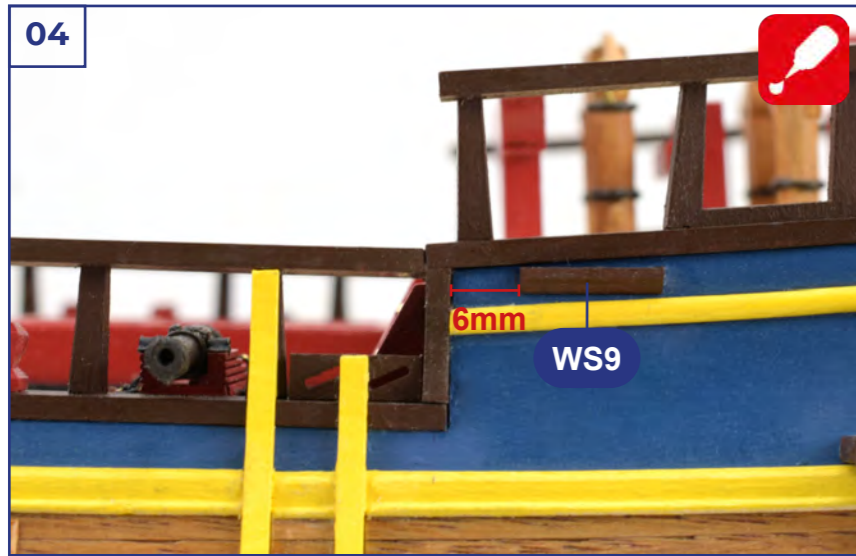

10



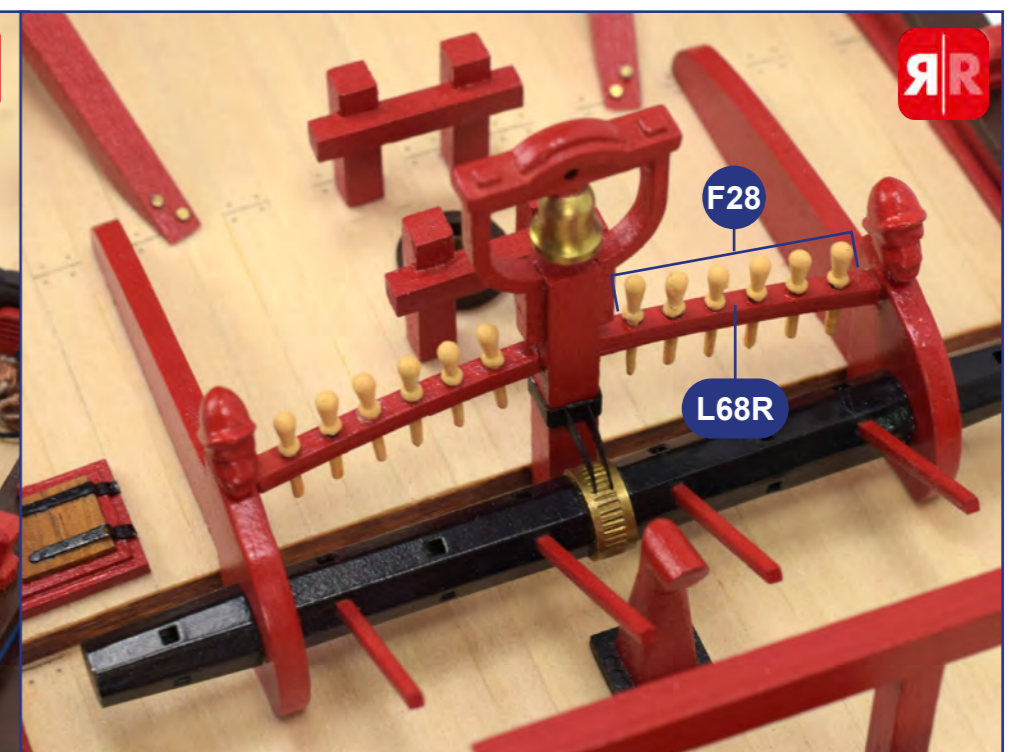
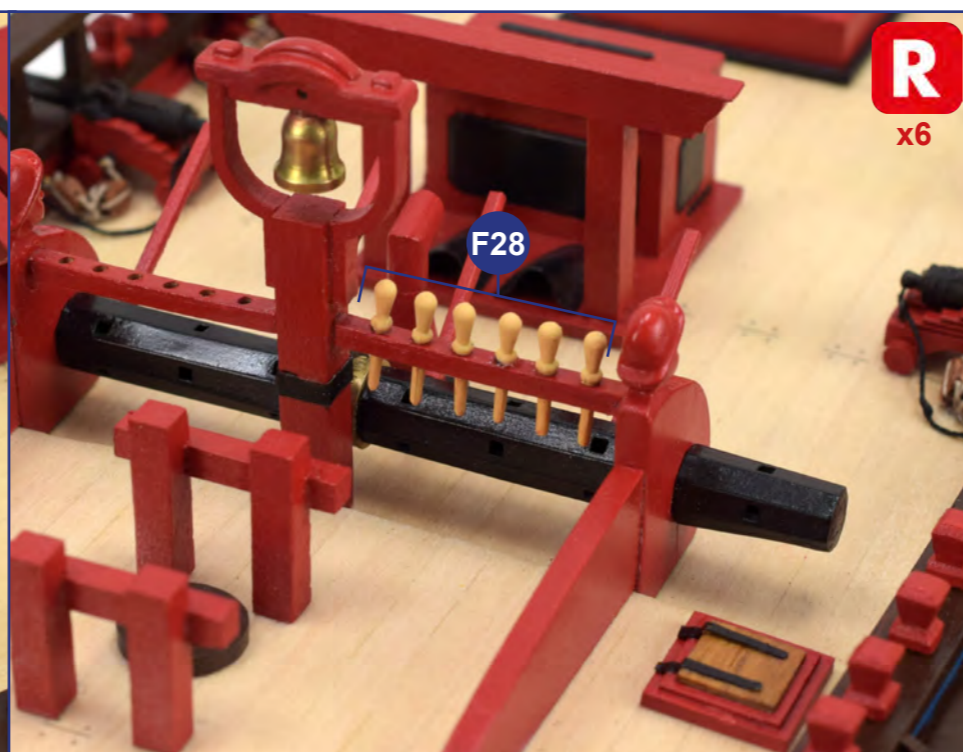
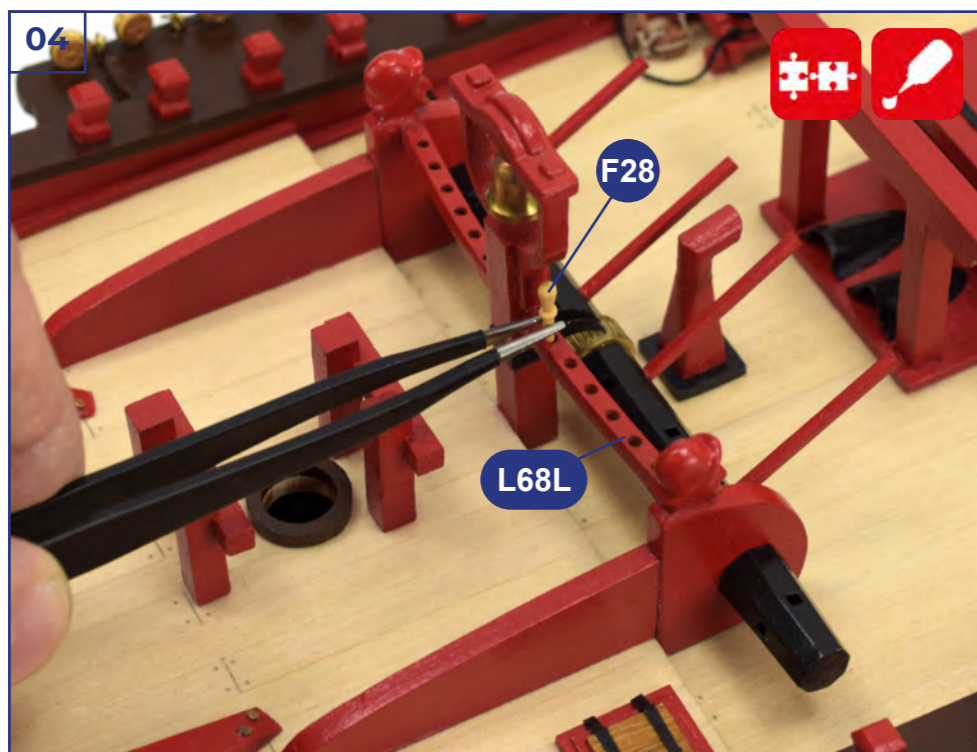
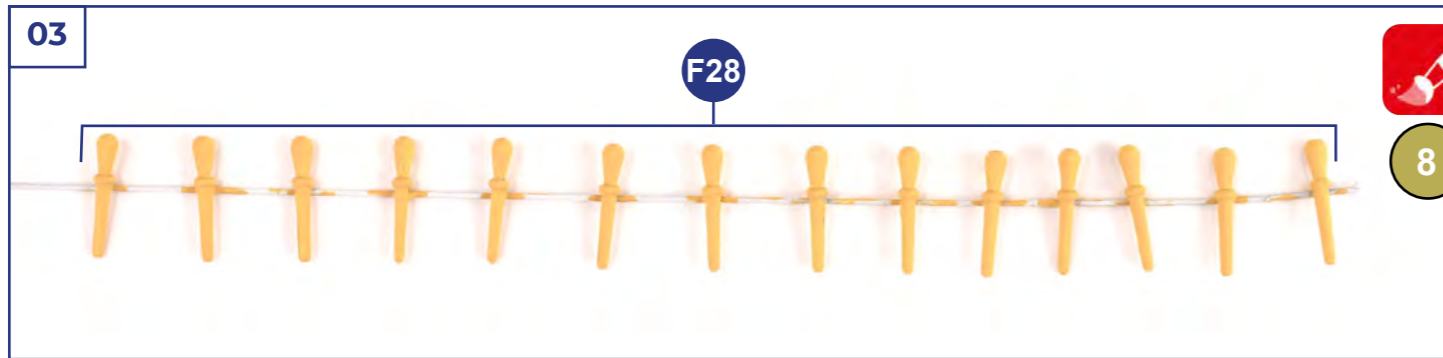
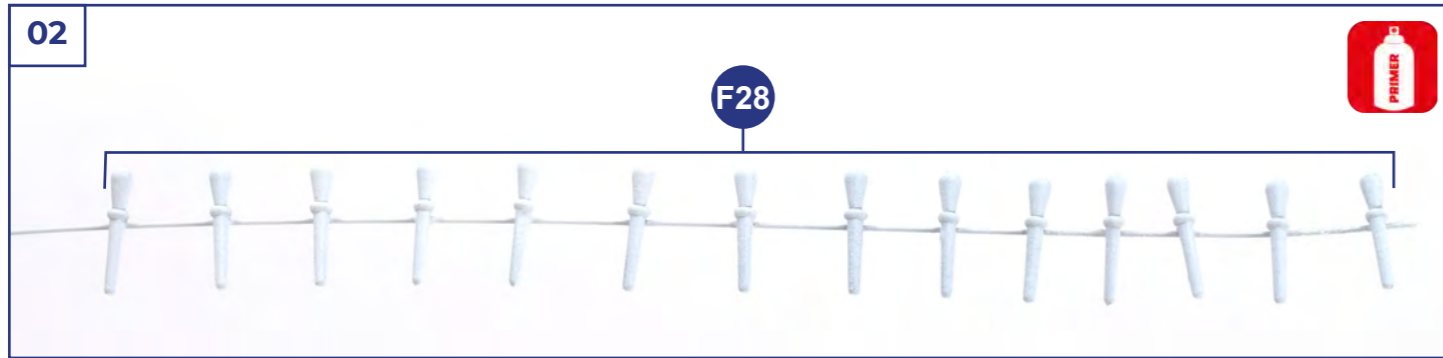
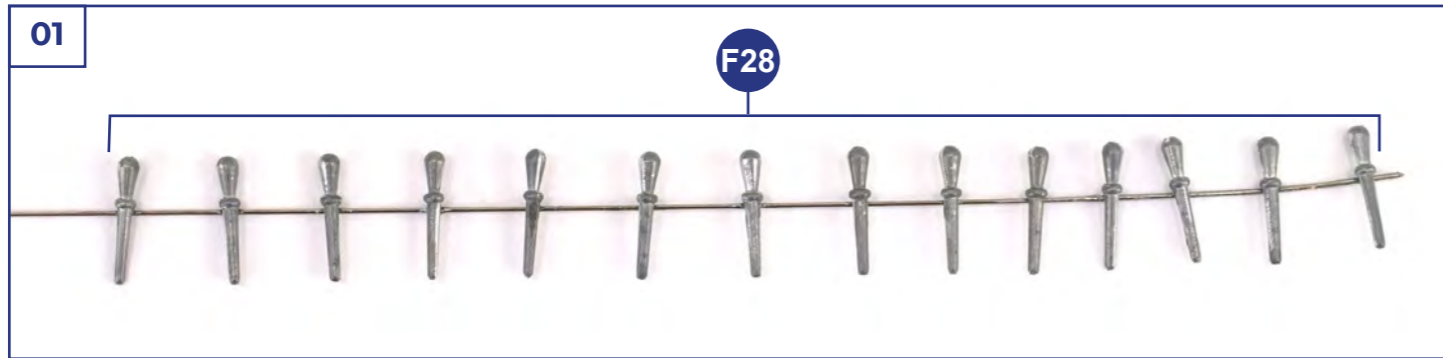

01

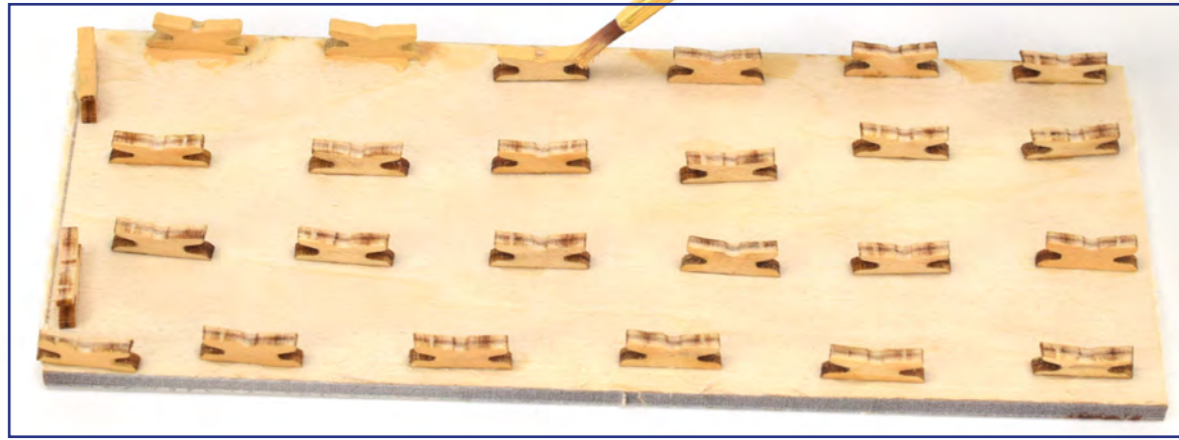

L108
x64

03

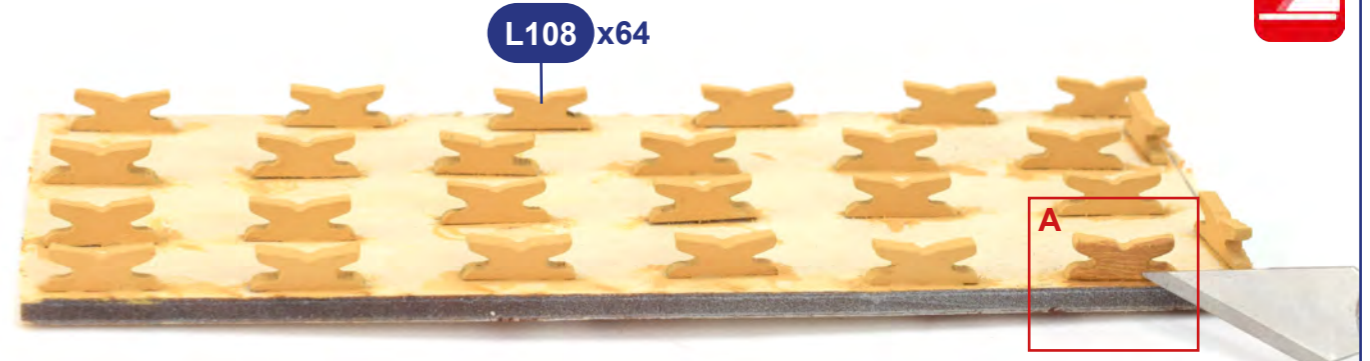

L108 x64

A

02

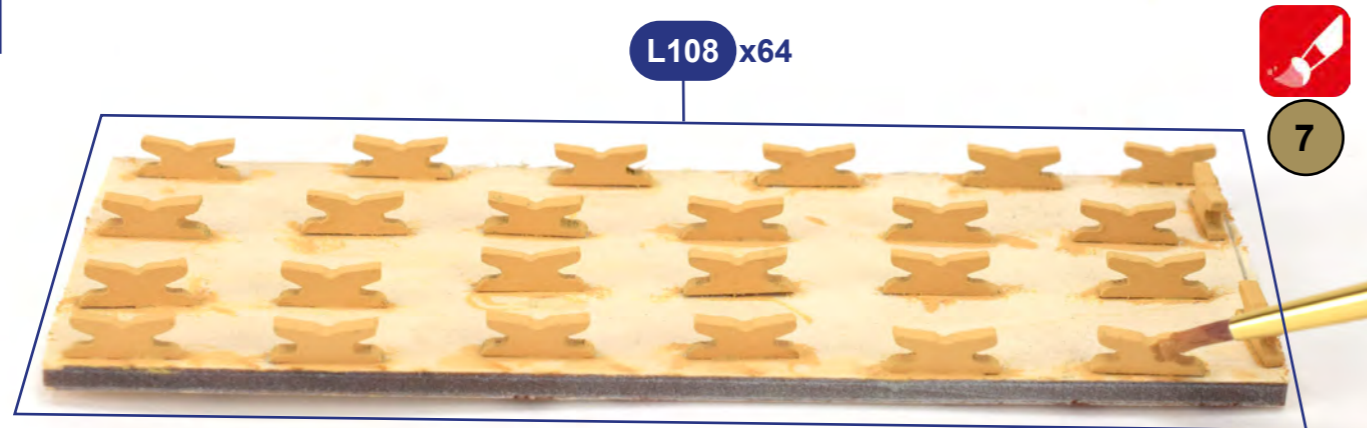

L108 x64

7



A

L108

04

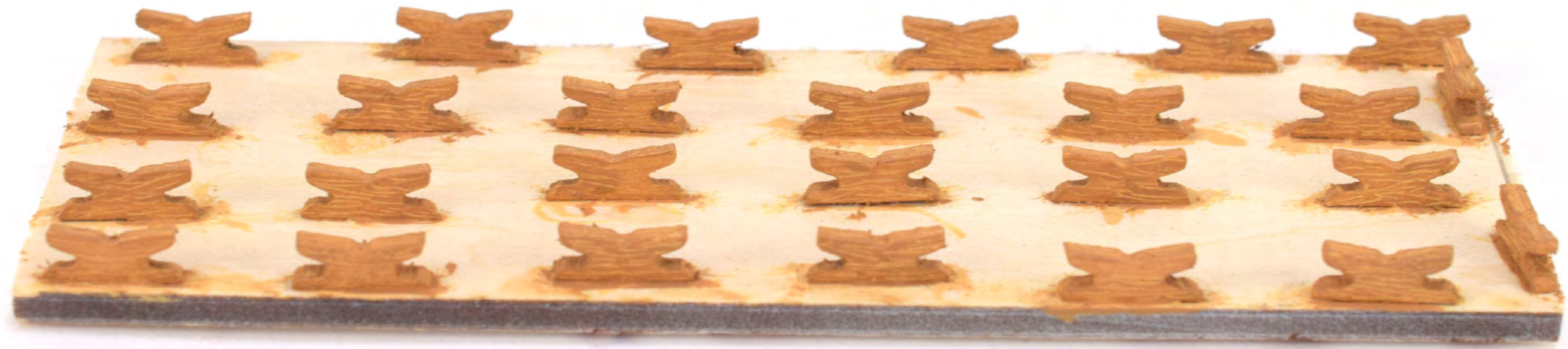

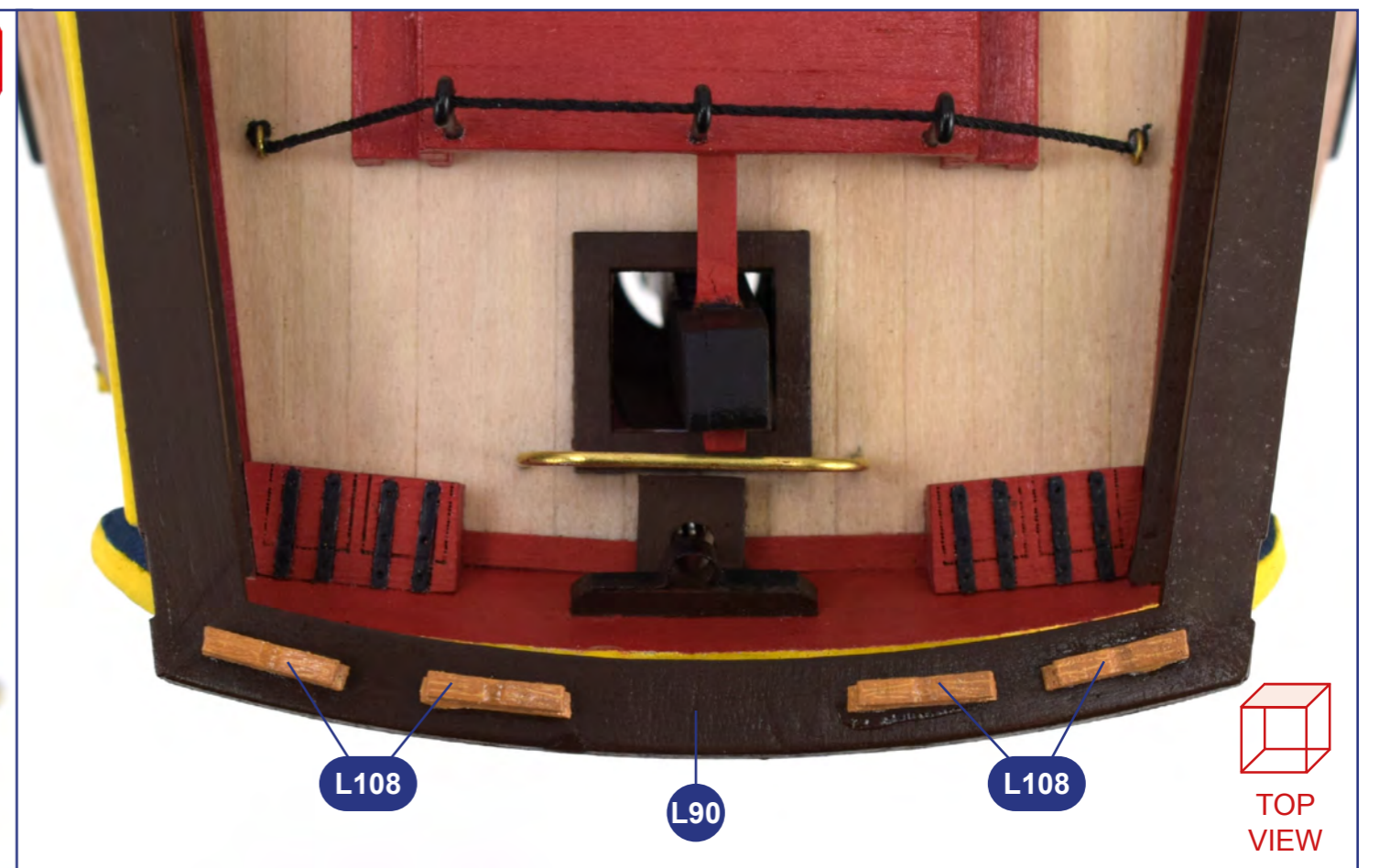
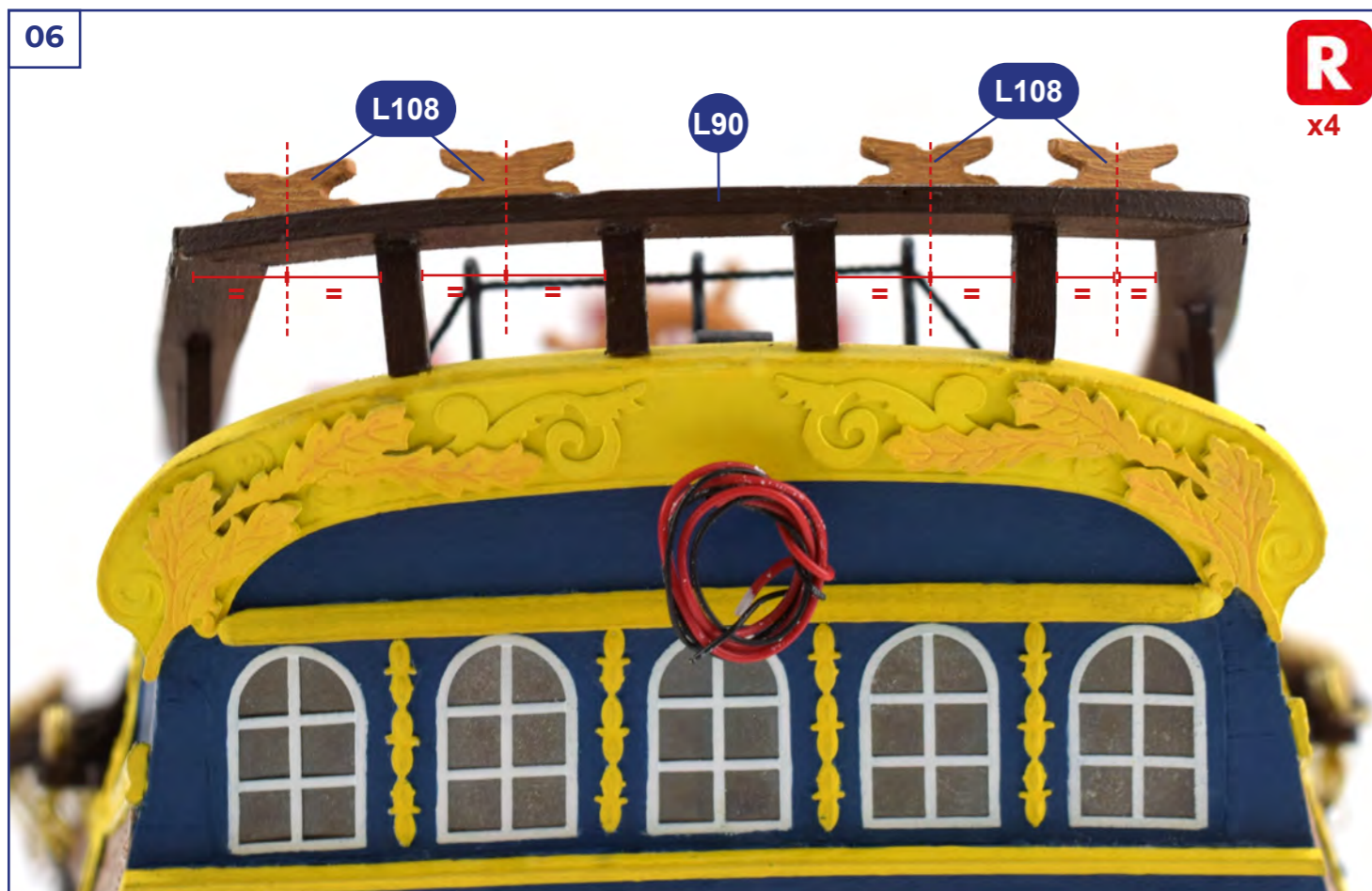
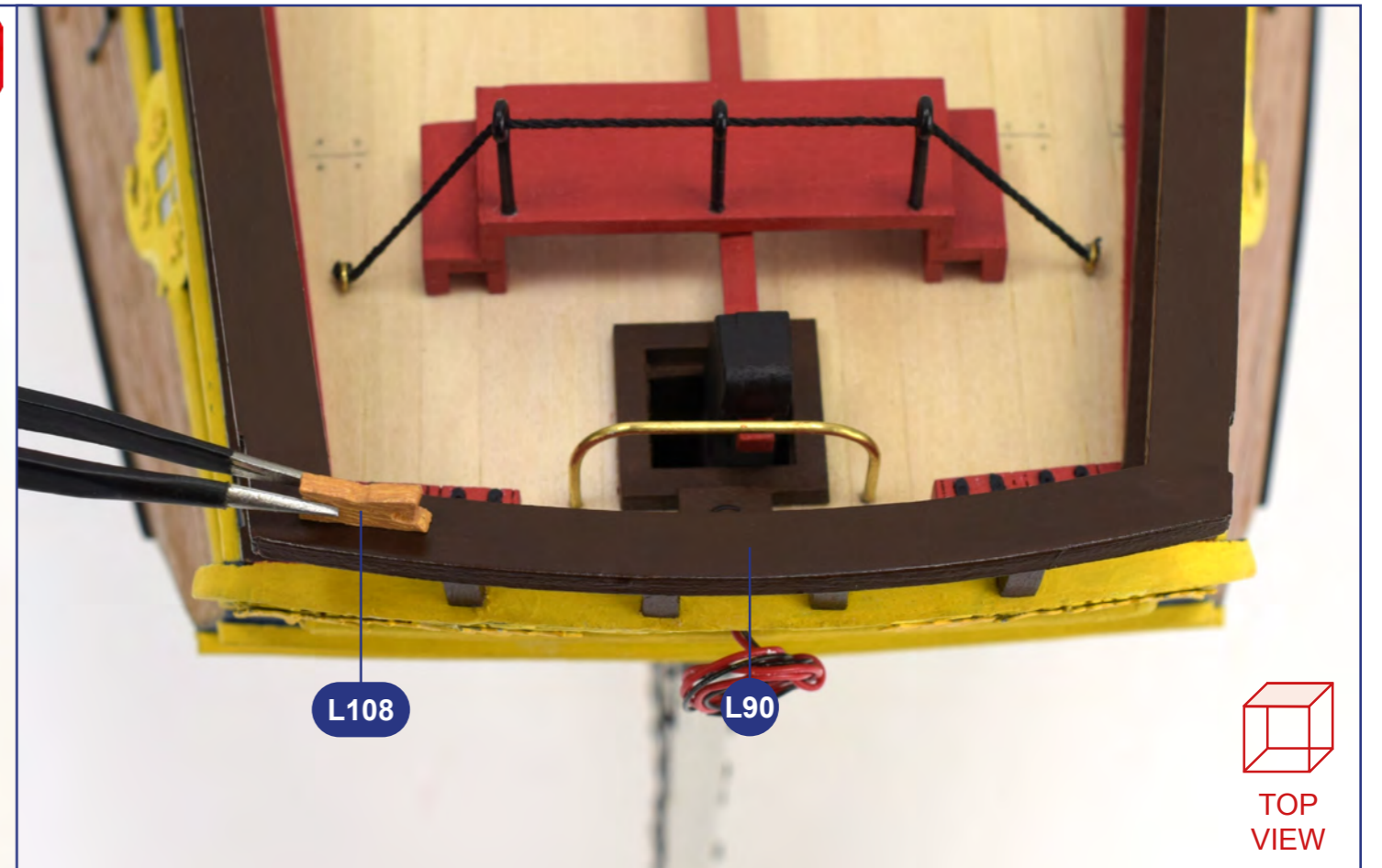
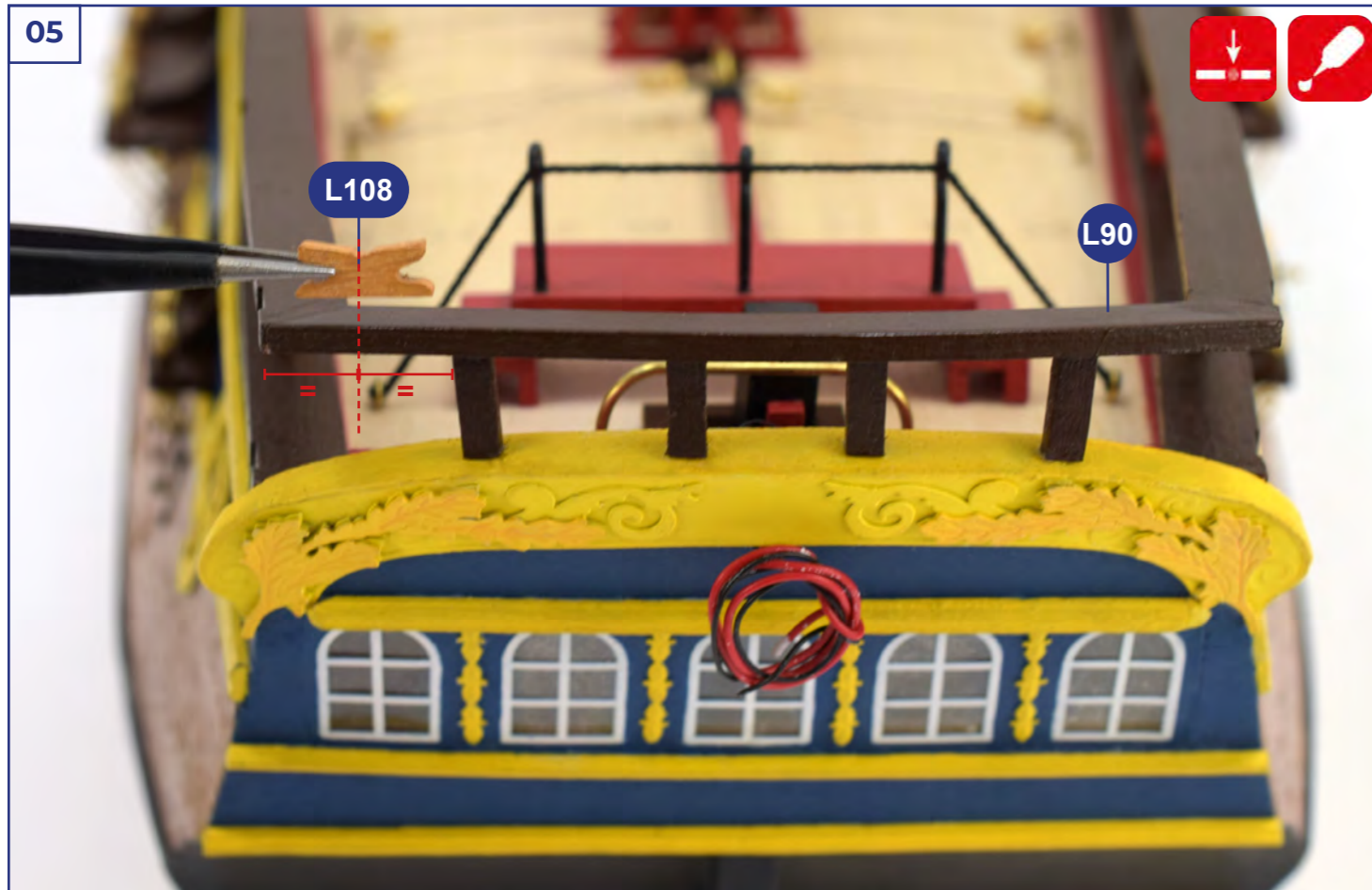

**La Section 32 muestra el montaje completo del palo Trinquete.
Los otros palos se montan de forma similar a este.**

**Section 32 shows how to assemble the Foremast.
The two other mast are built in a similar way.**

**La section 32 montre le montage complet du mât de Misaine.
Les deux autres mâts se montent de façon similaire.**

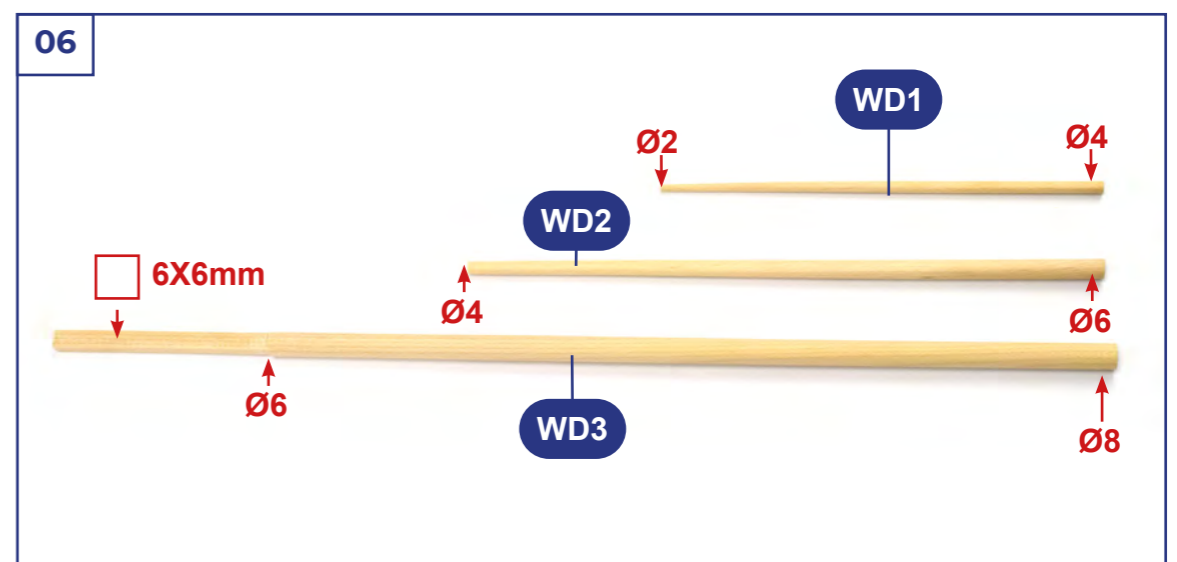
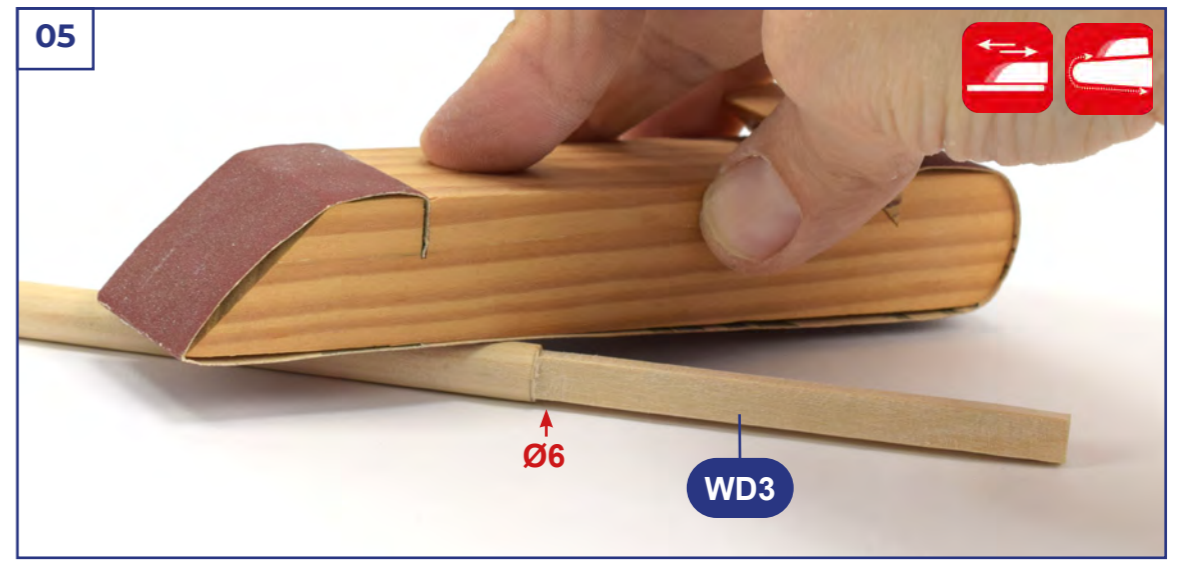
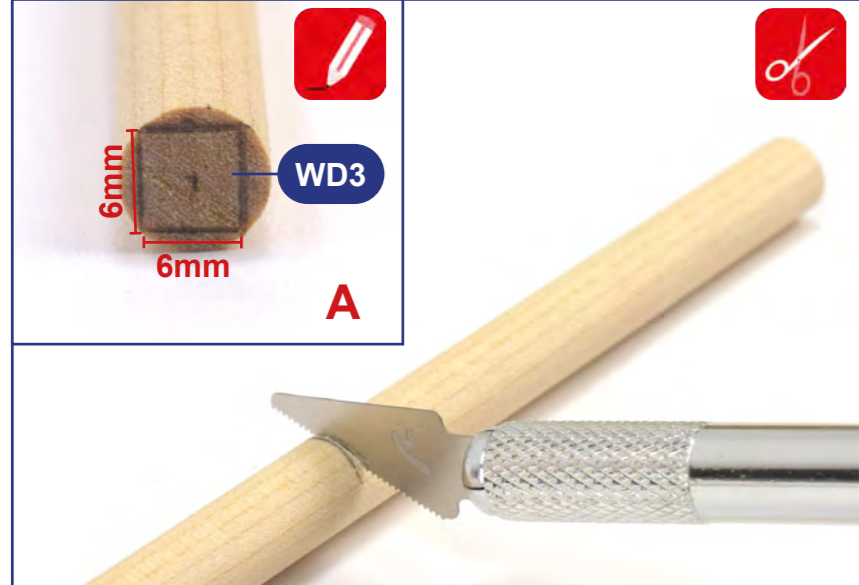
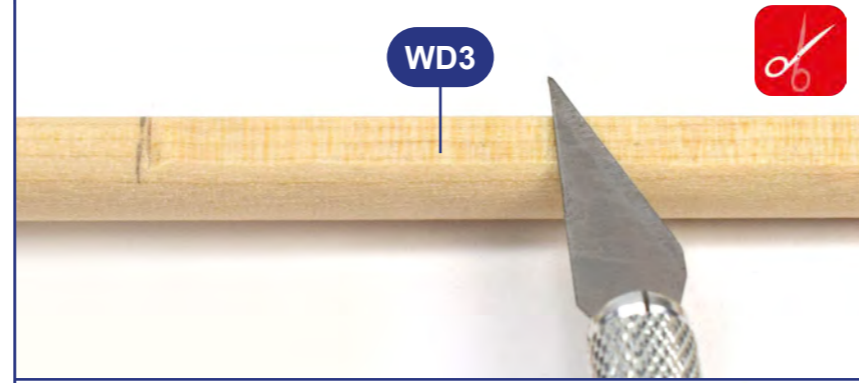
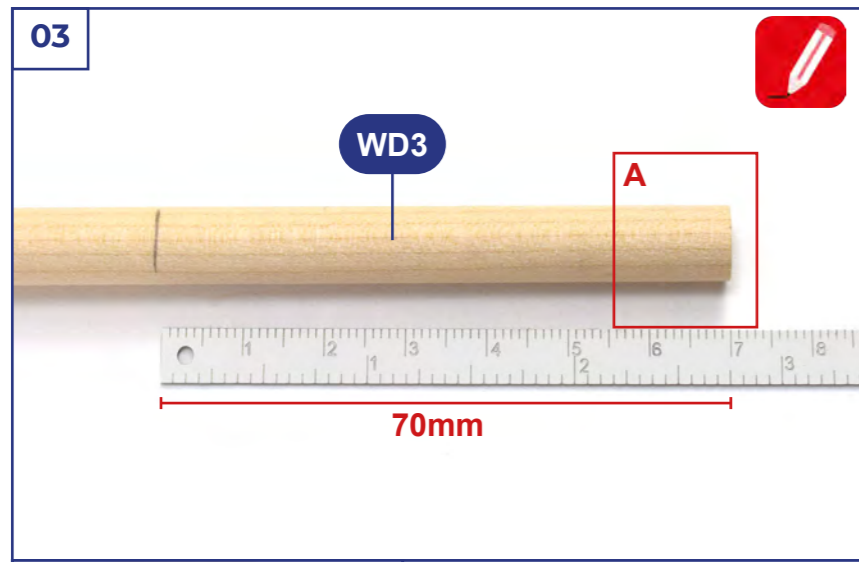
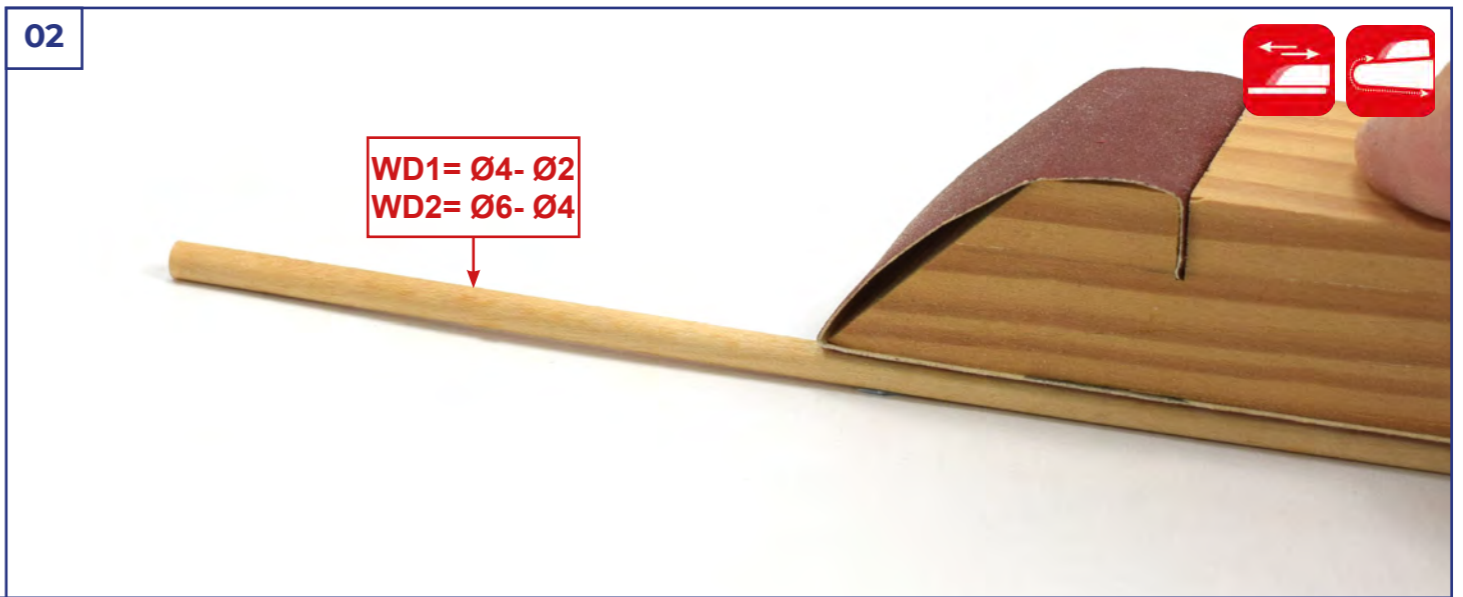
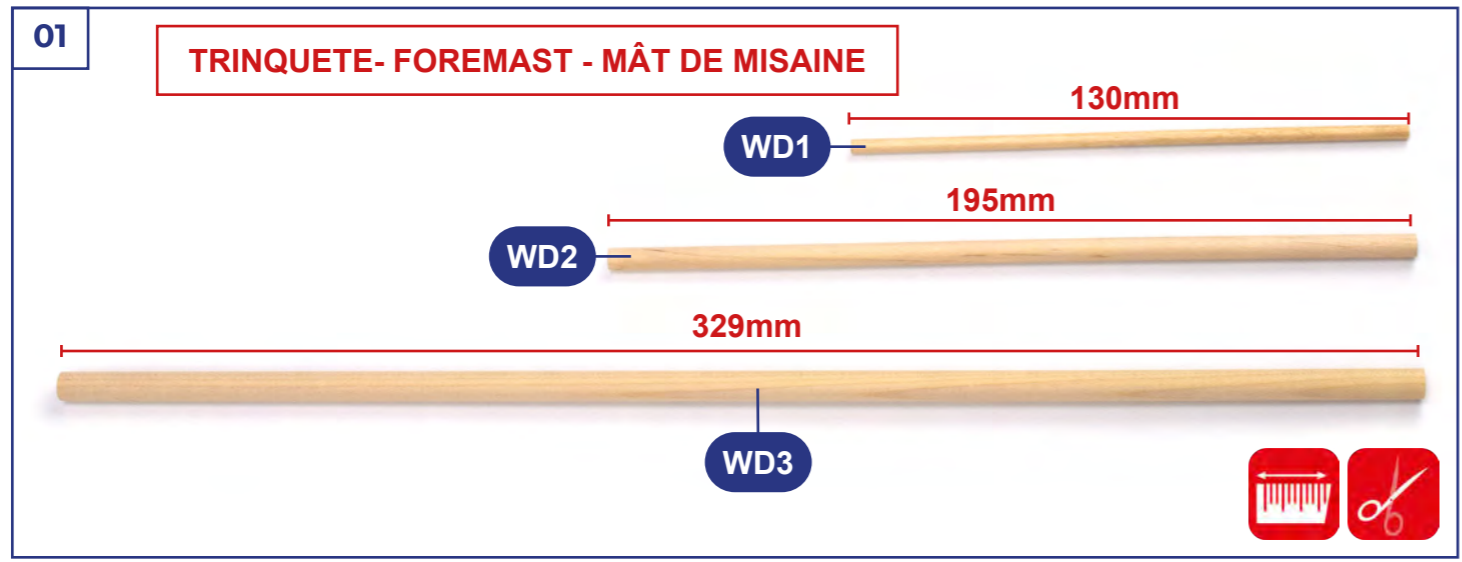

07



R

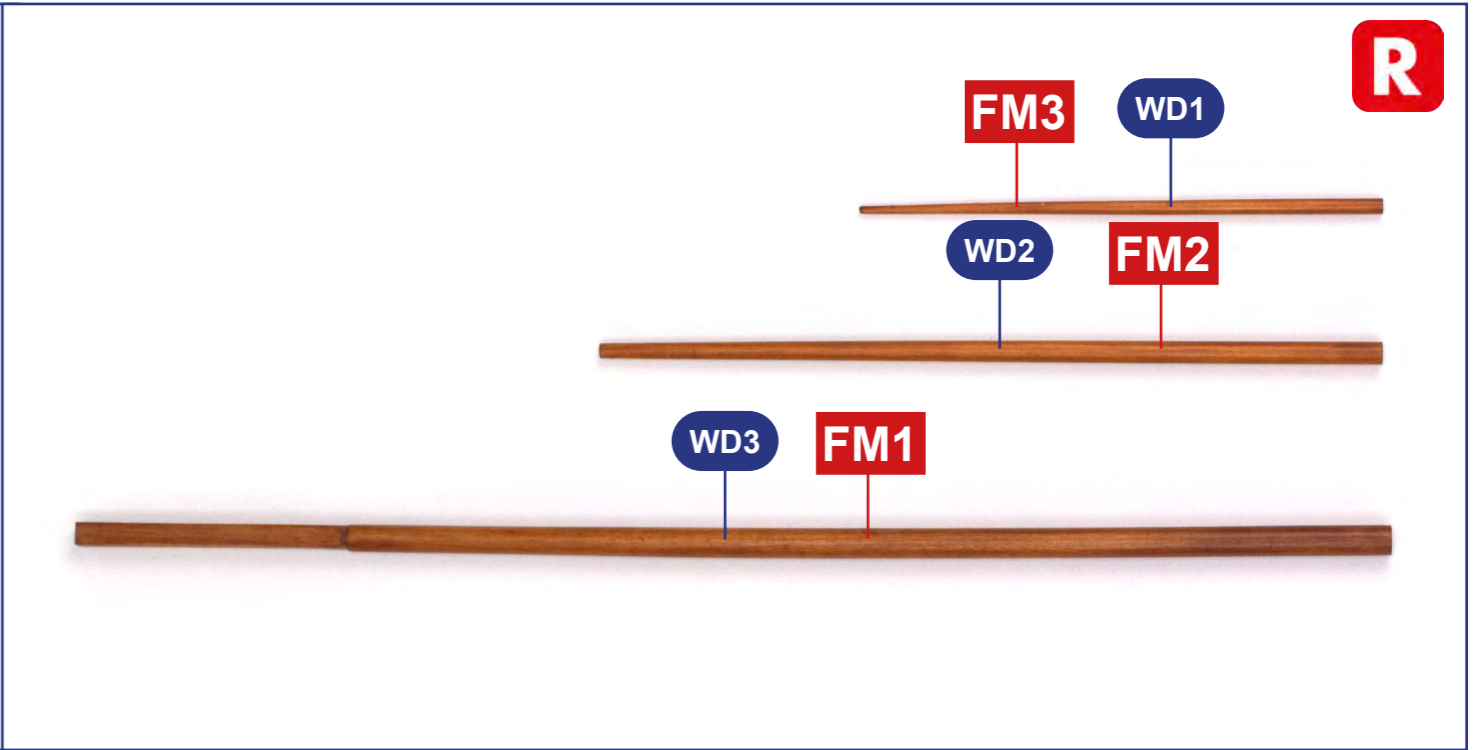

08

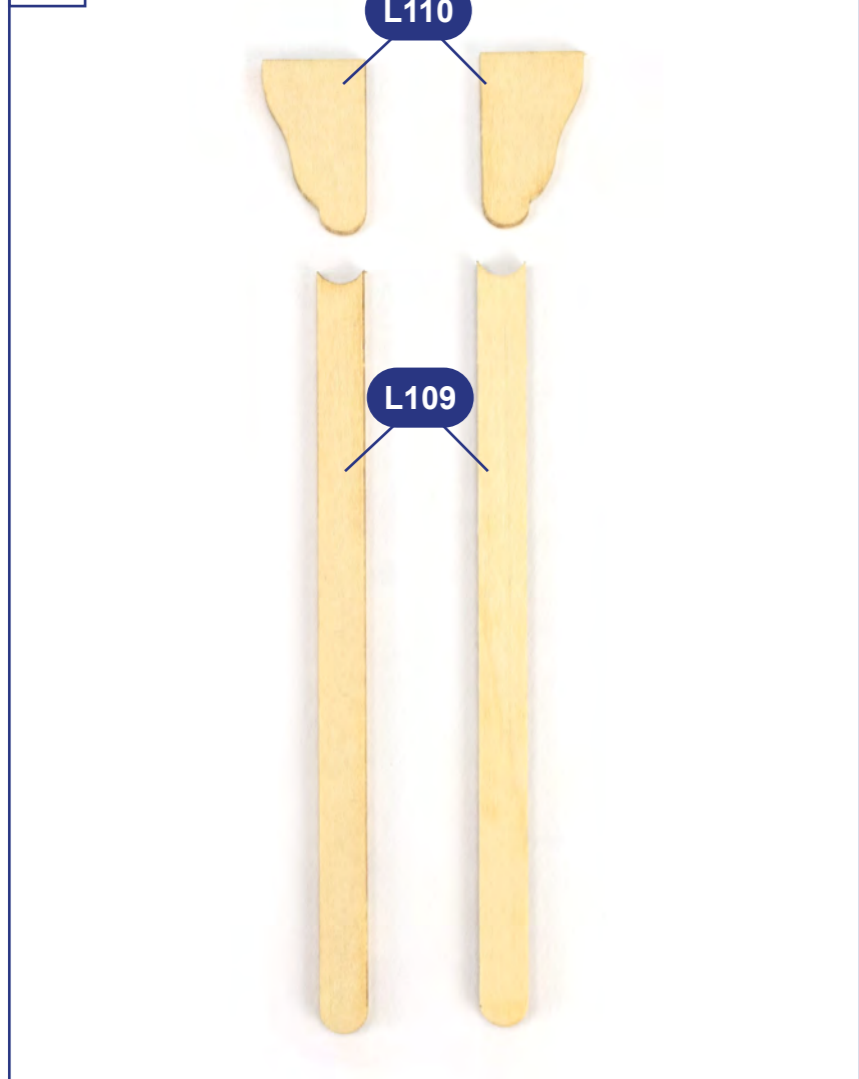

09

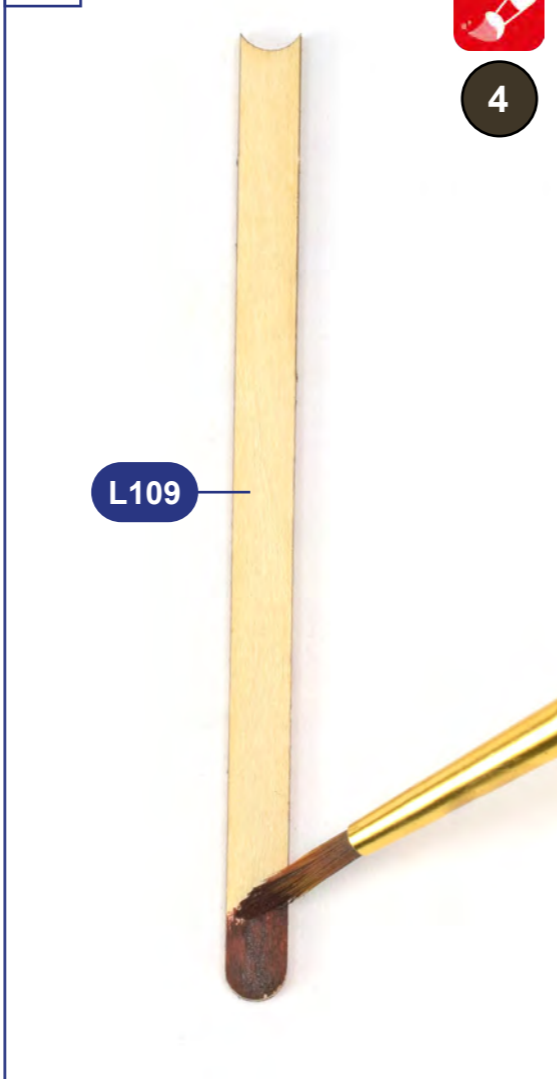

R



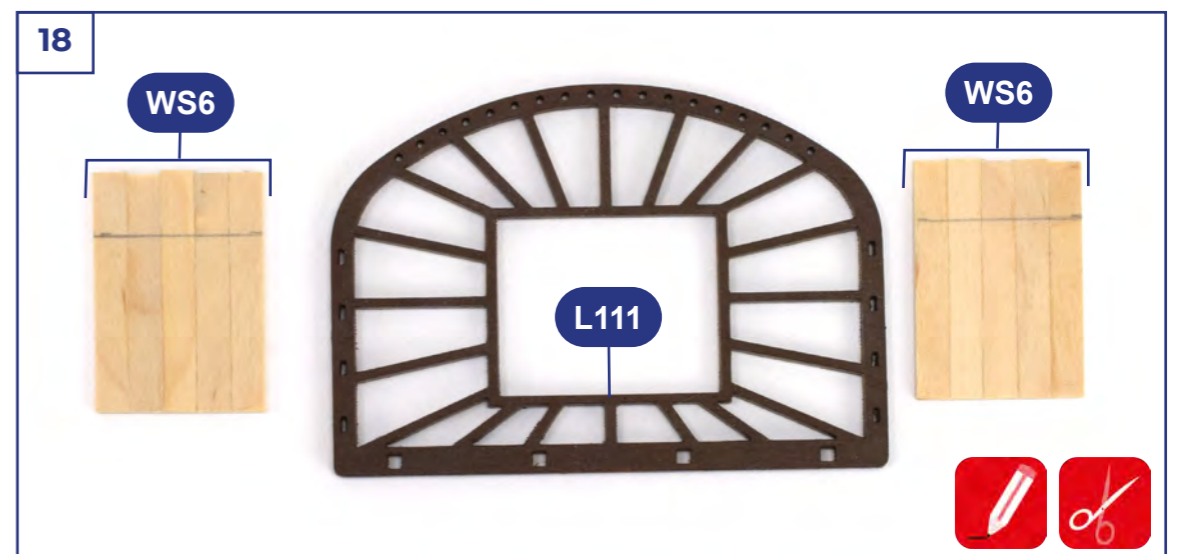
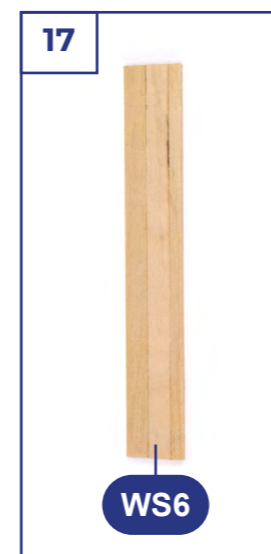
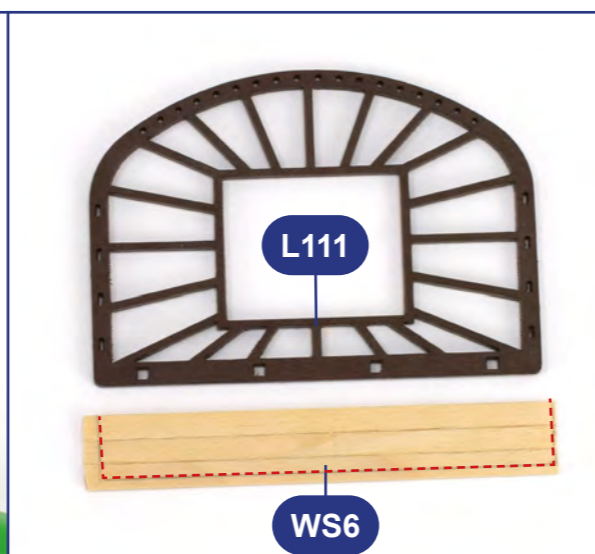
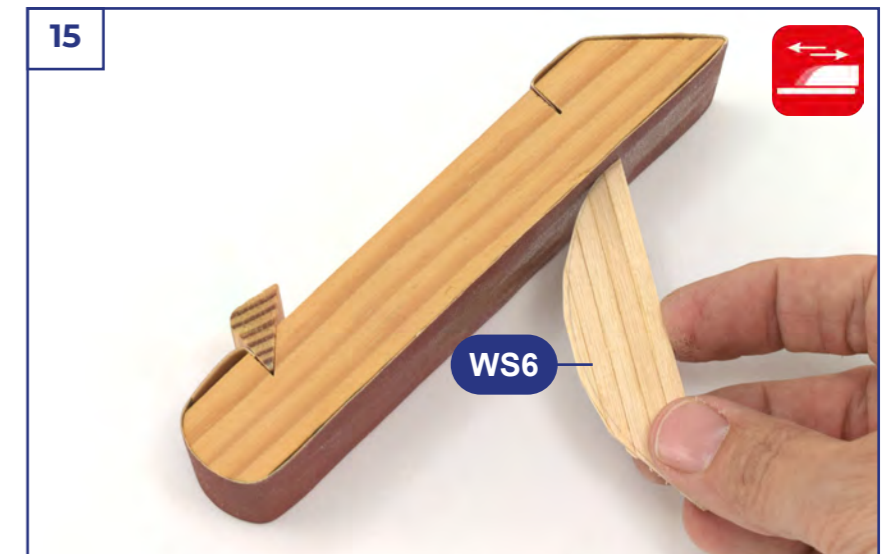
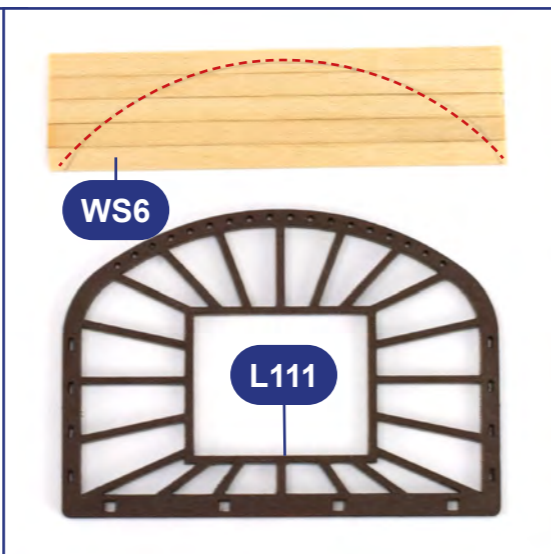
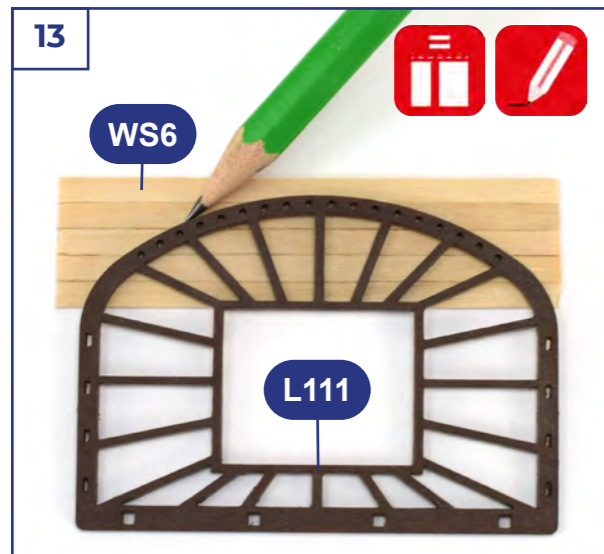
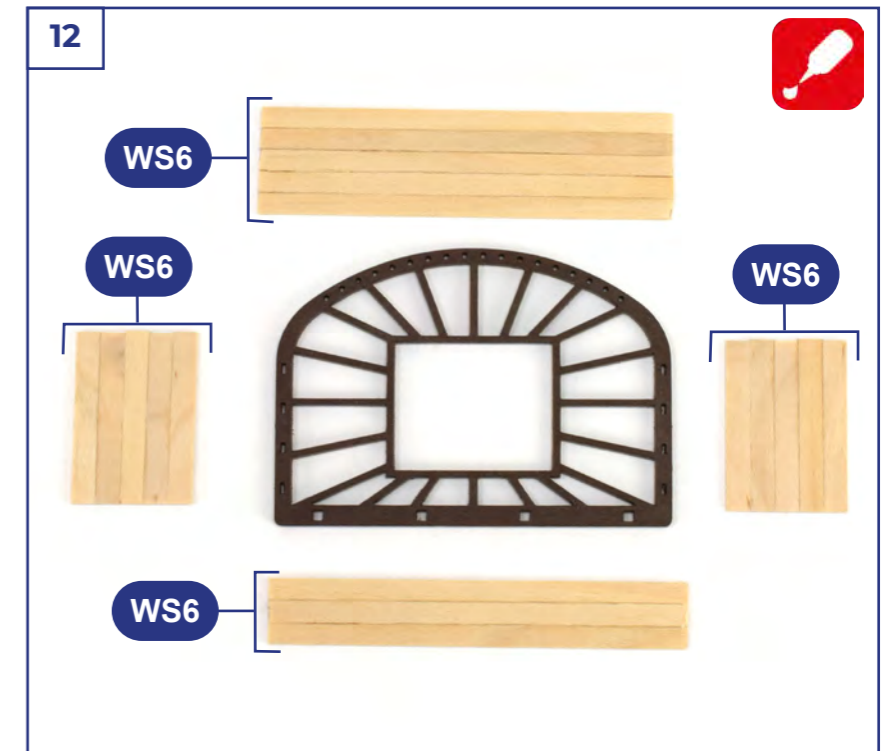
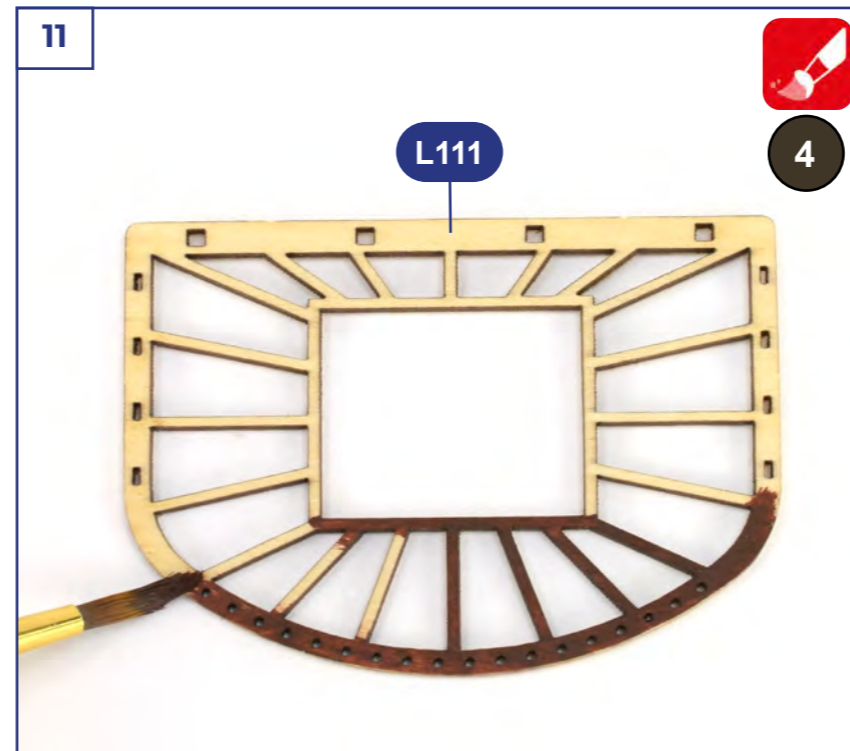
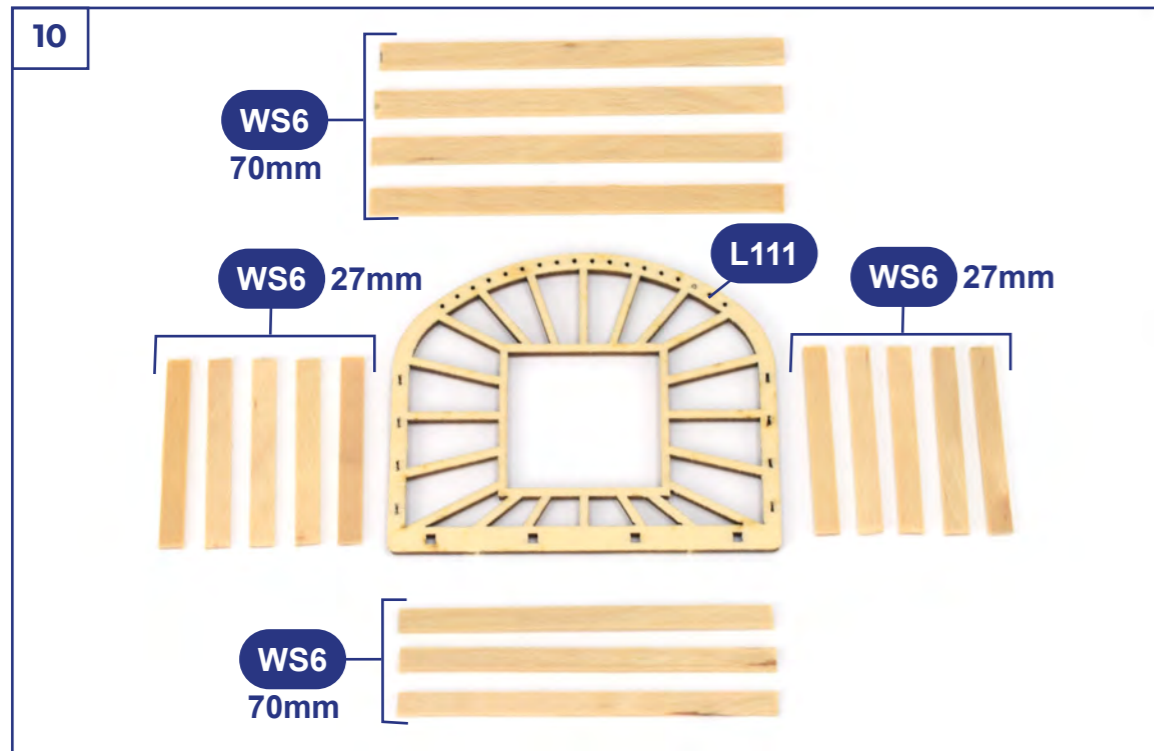

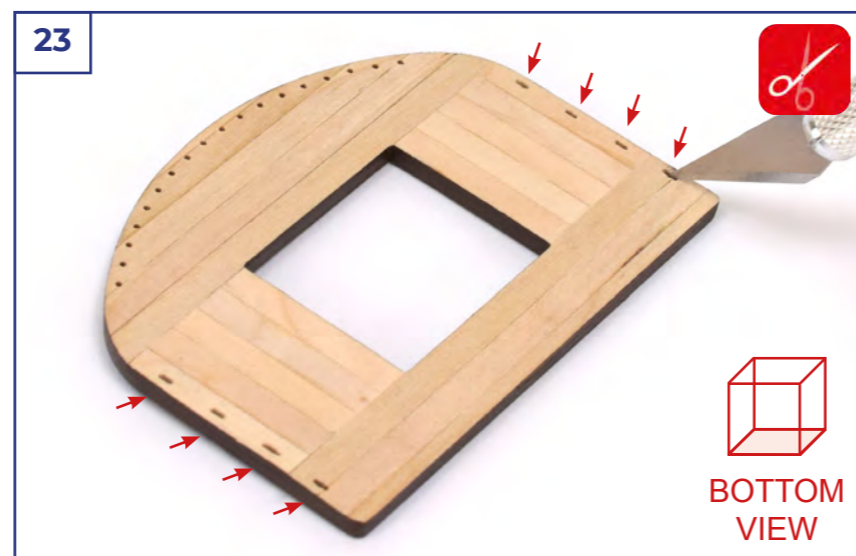
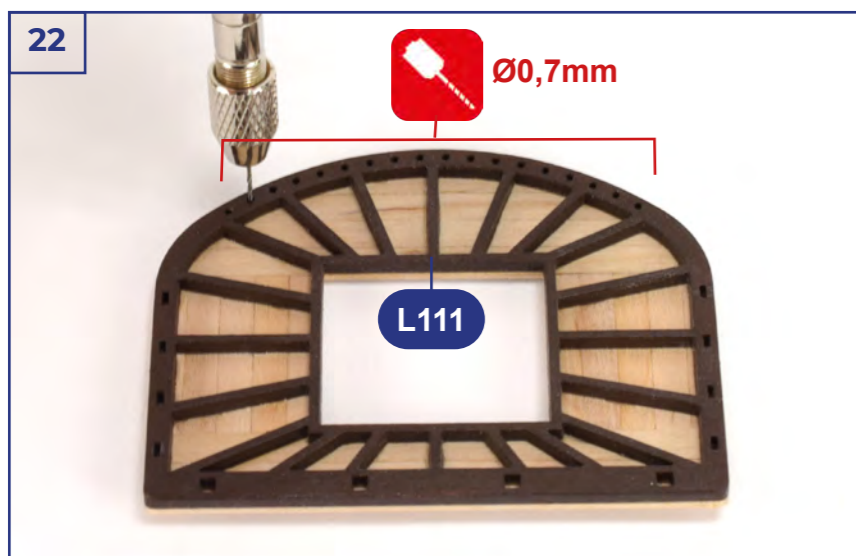
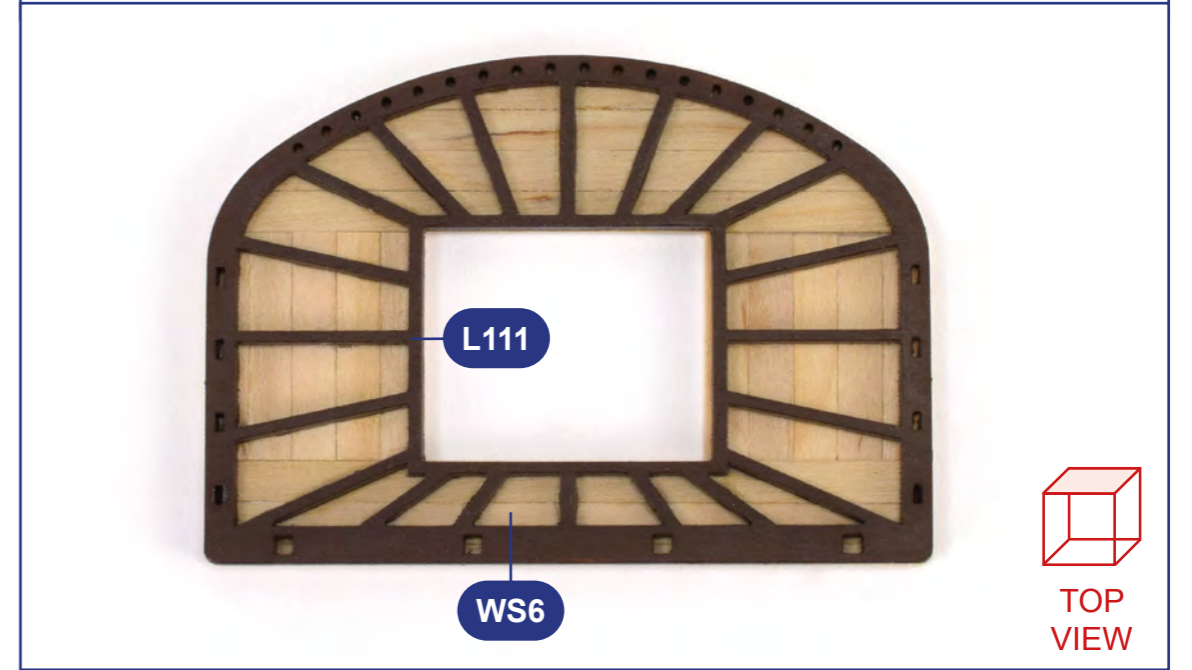
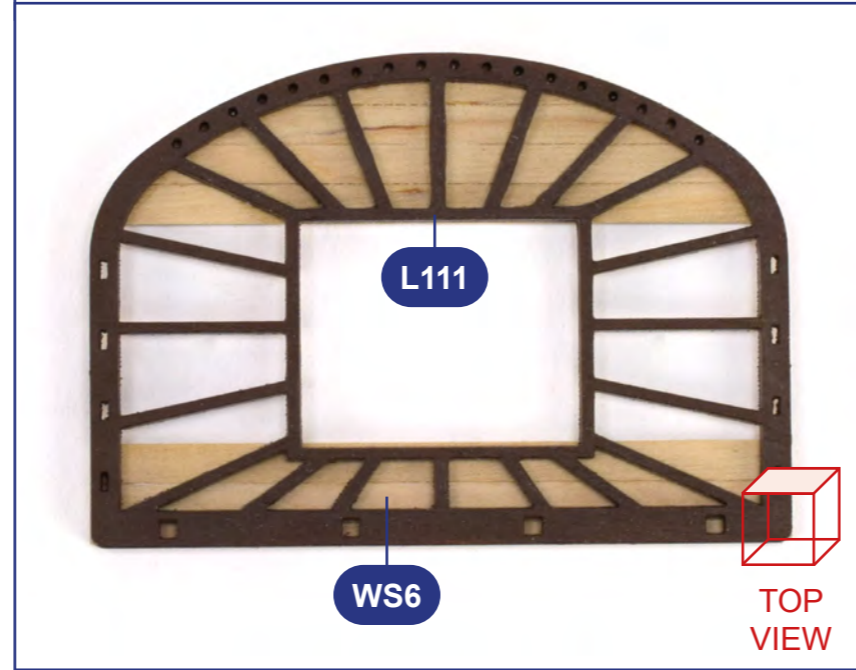
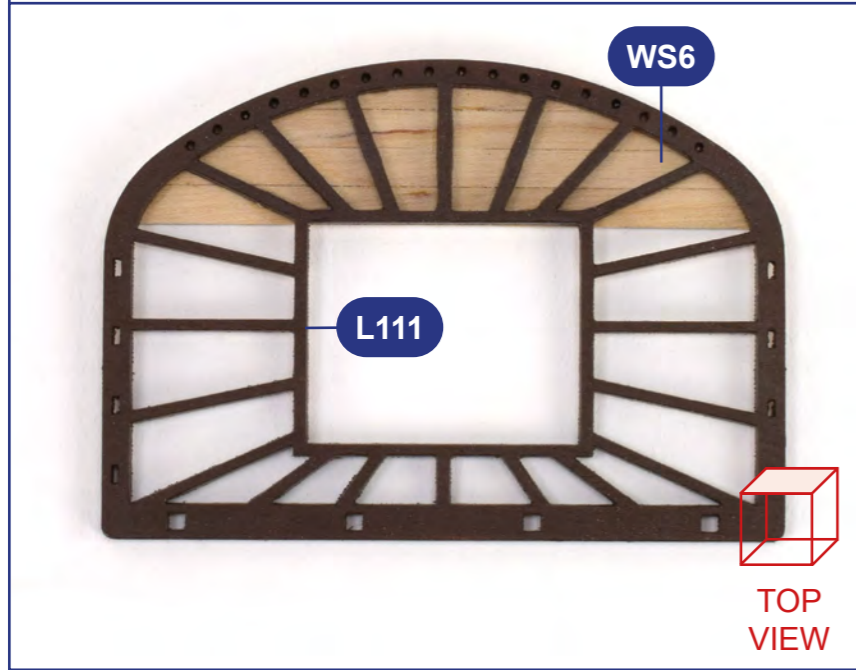
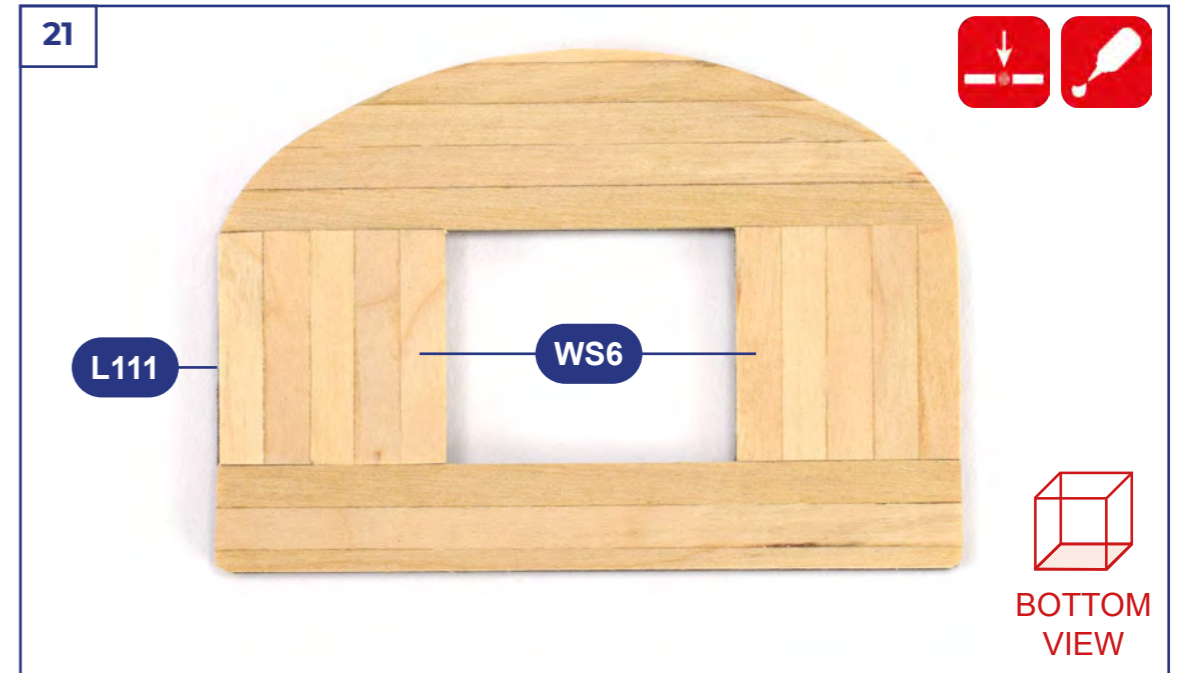
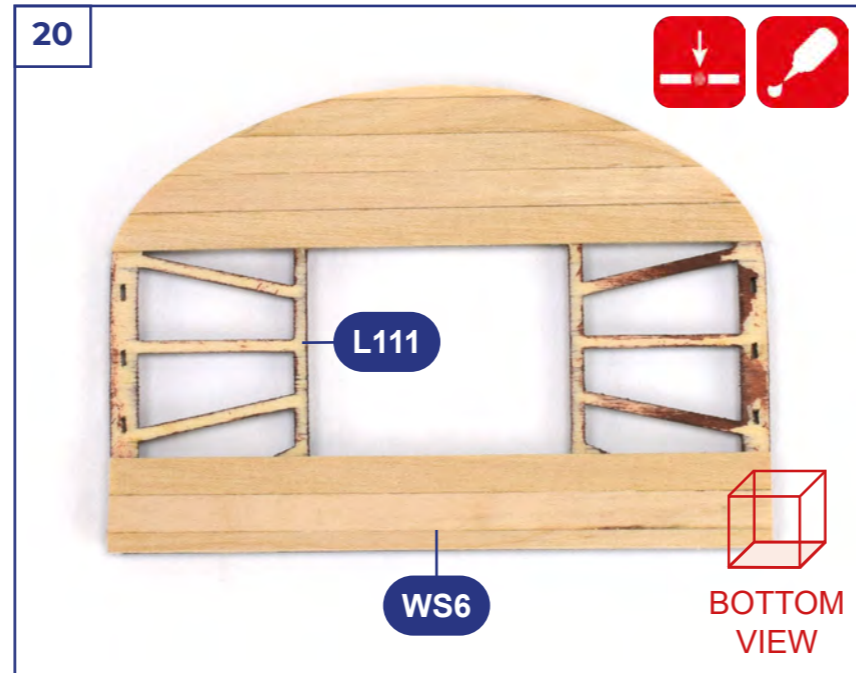
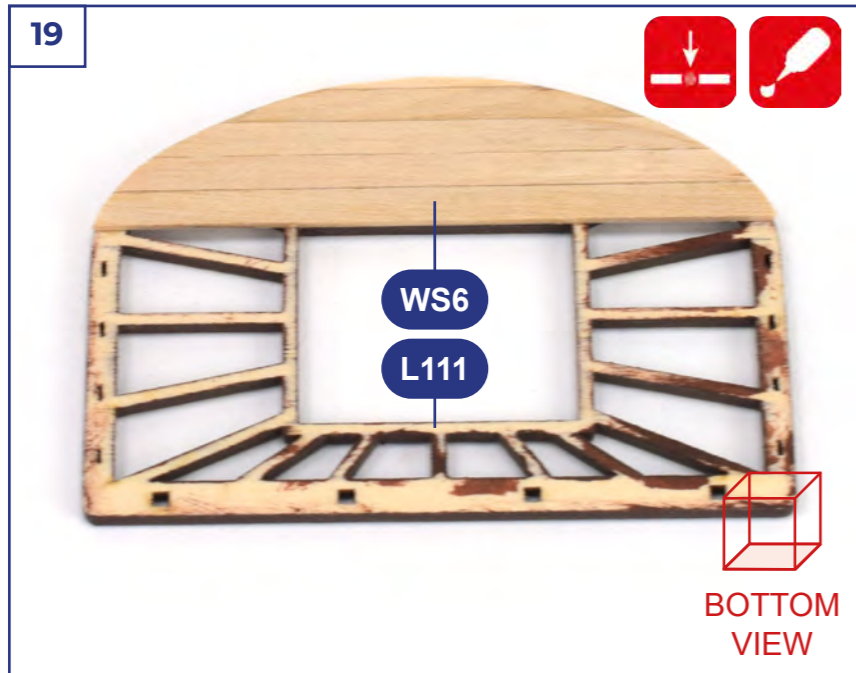

25

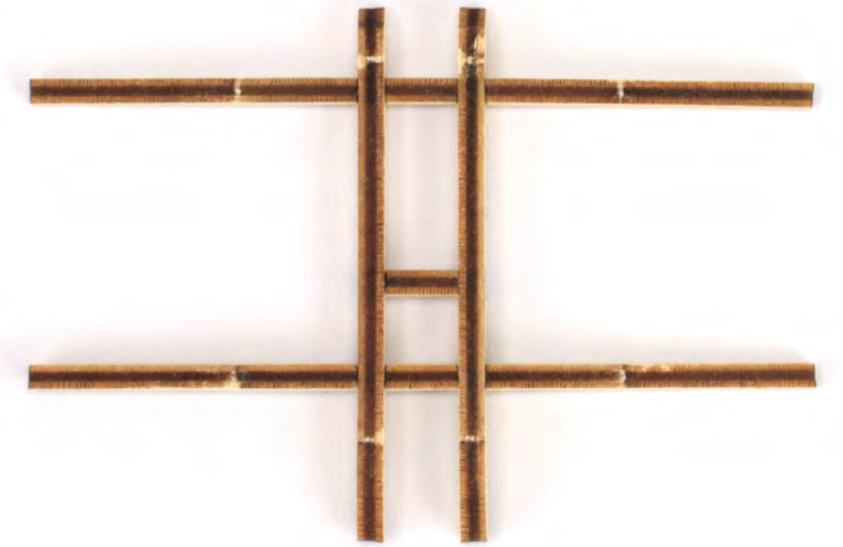
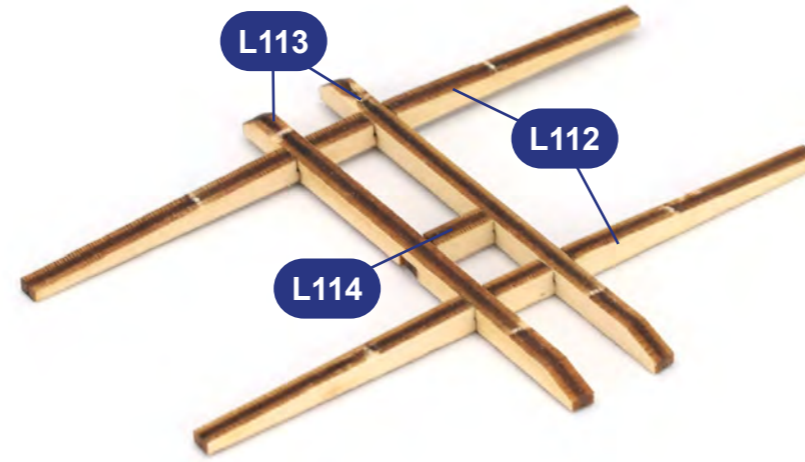
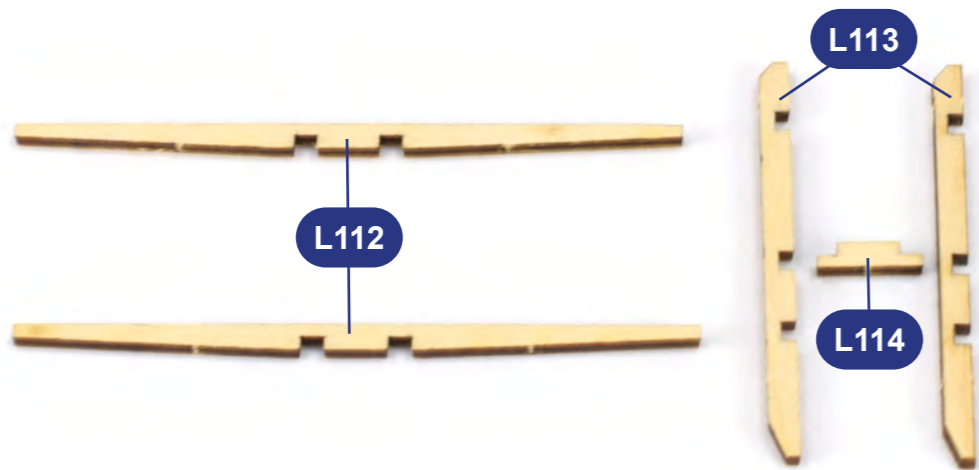

26

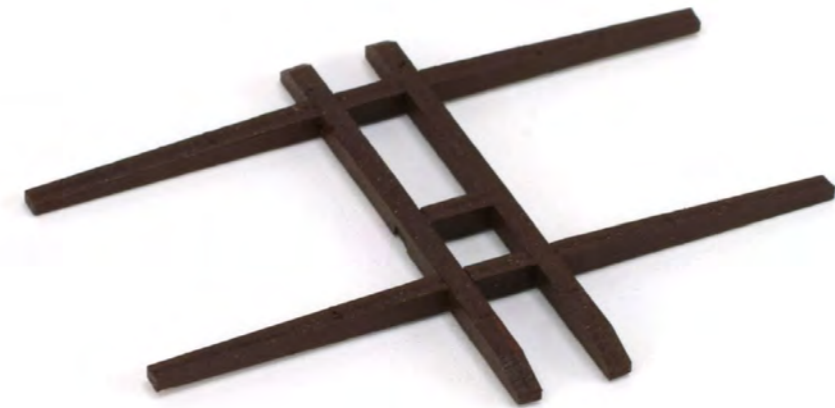
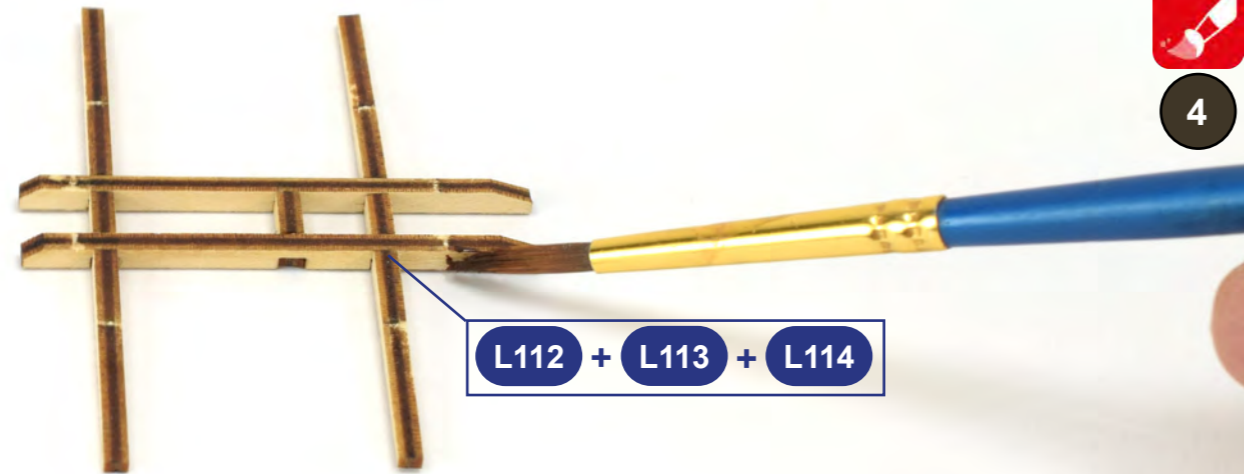

27

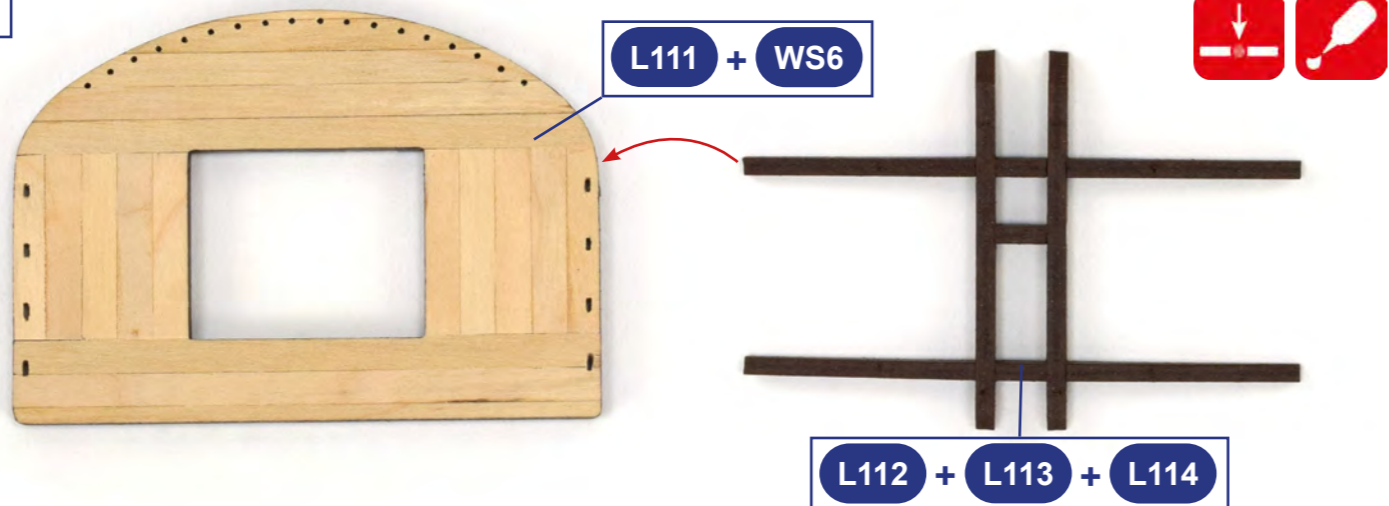

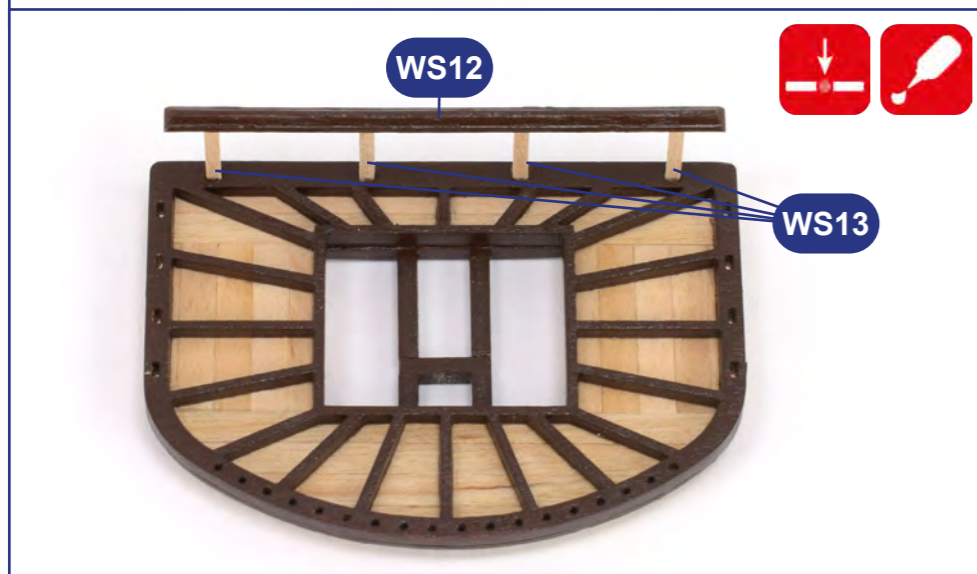
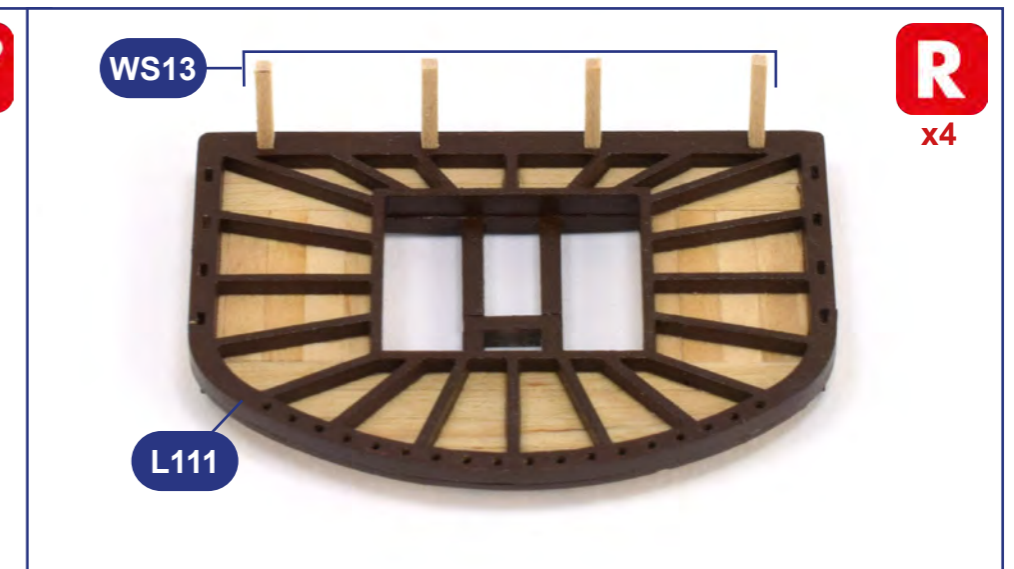
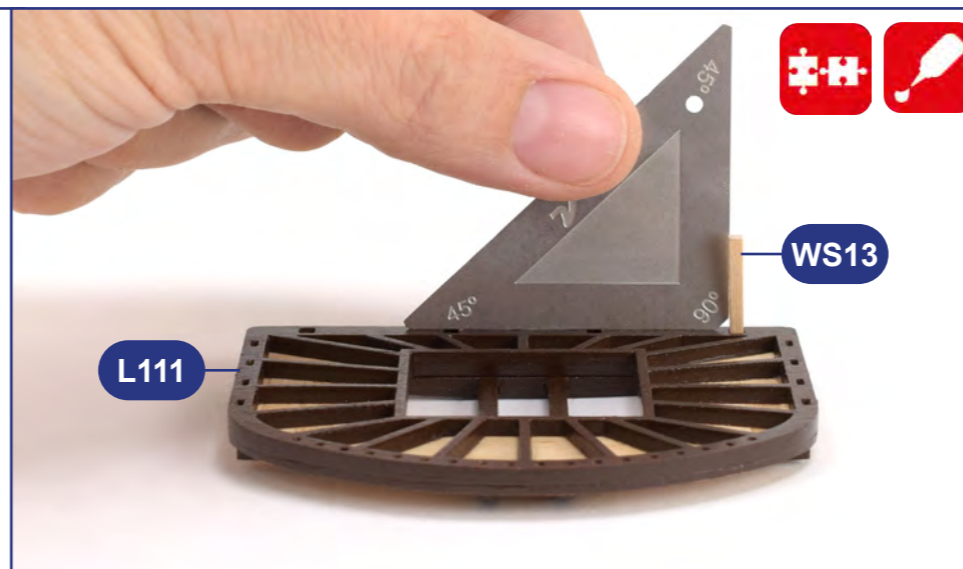
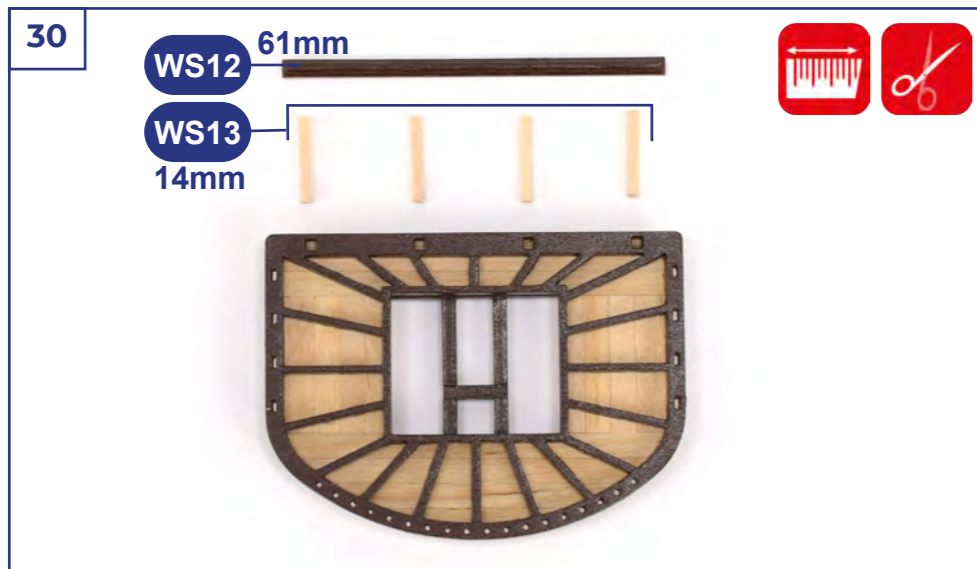
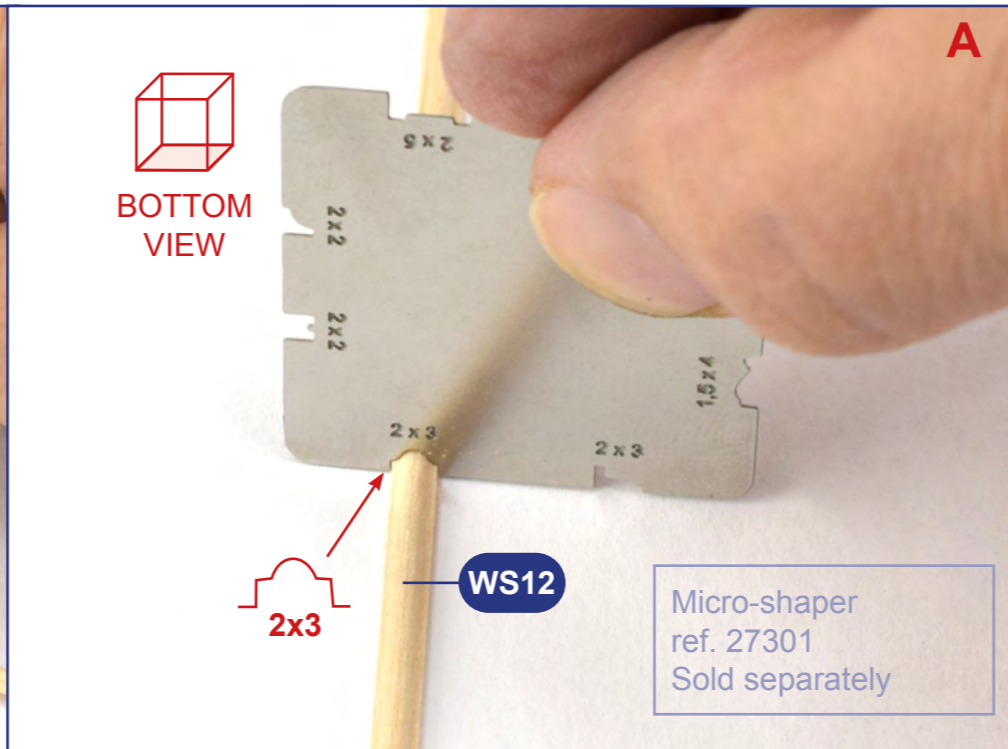
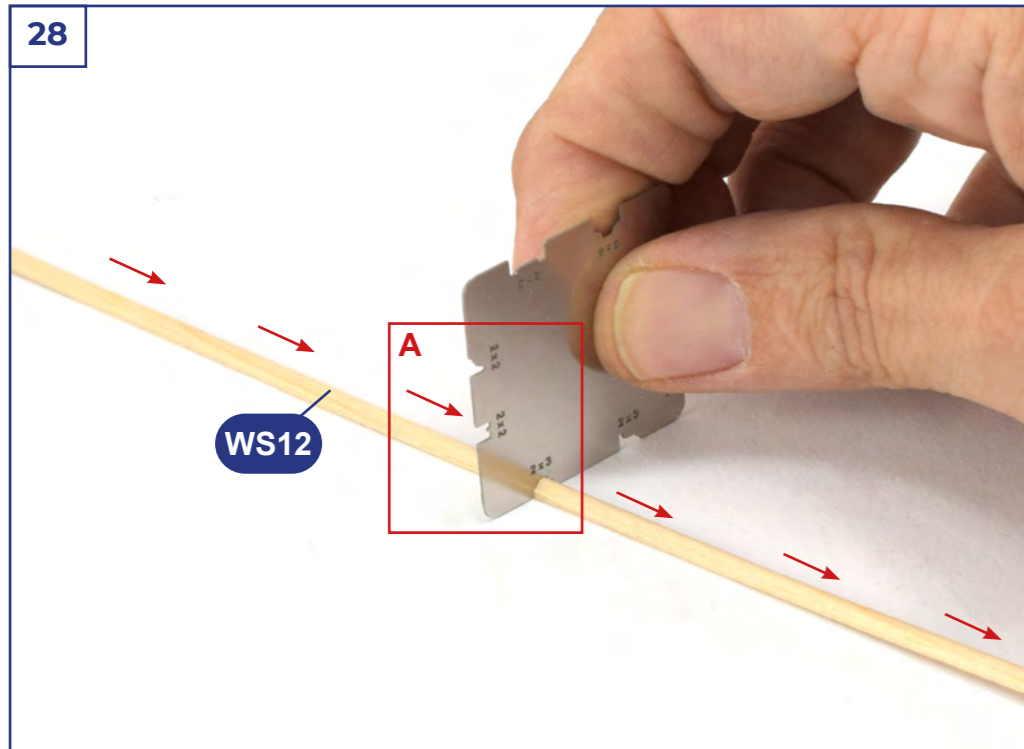

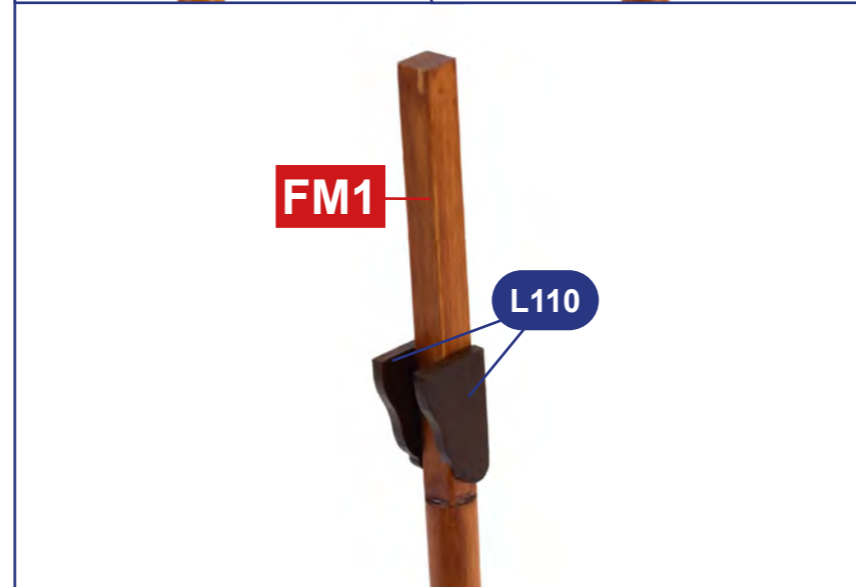
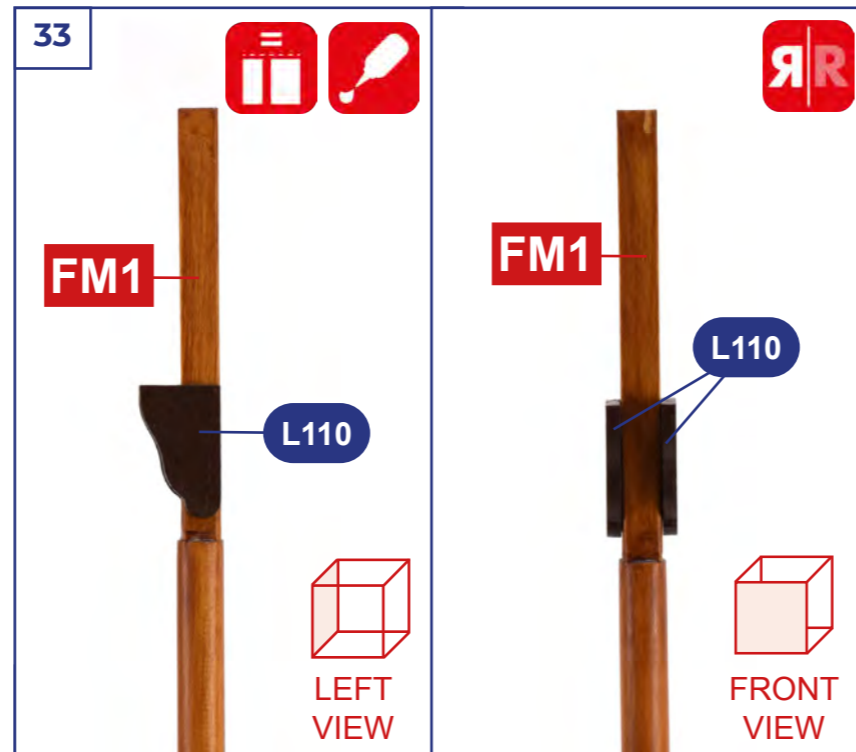
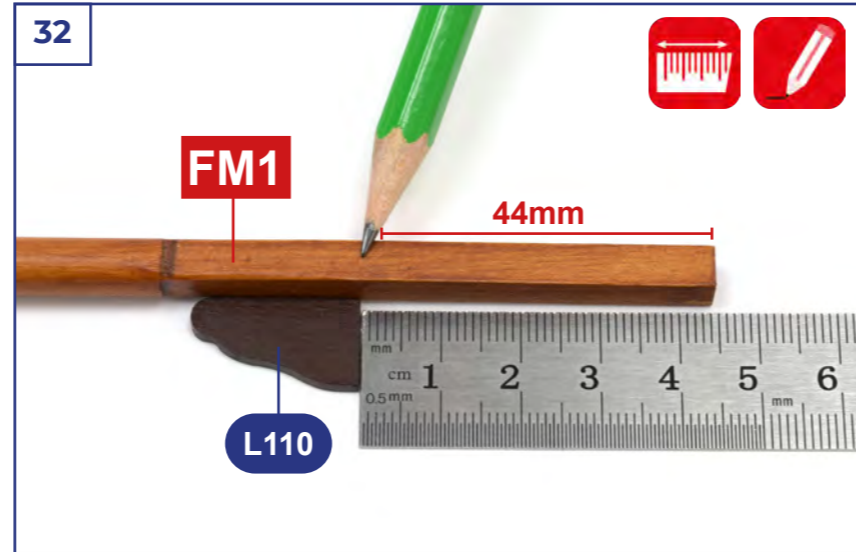

38



39

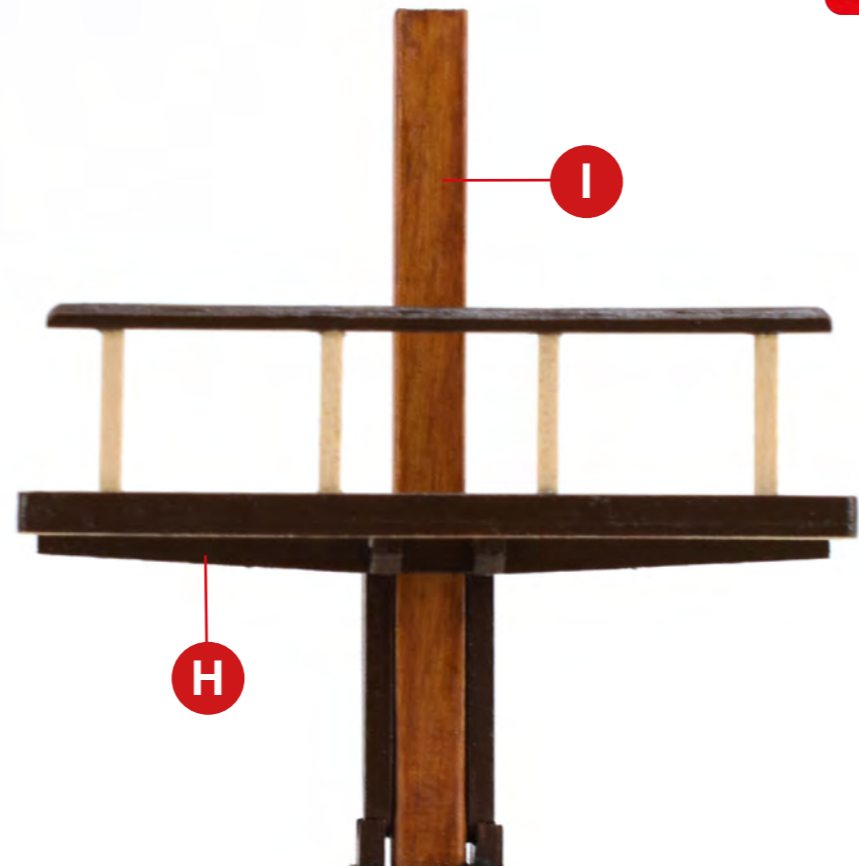

BACK VIEW

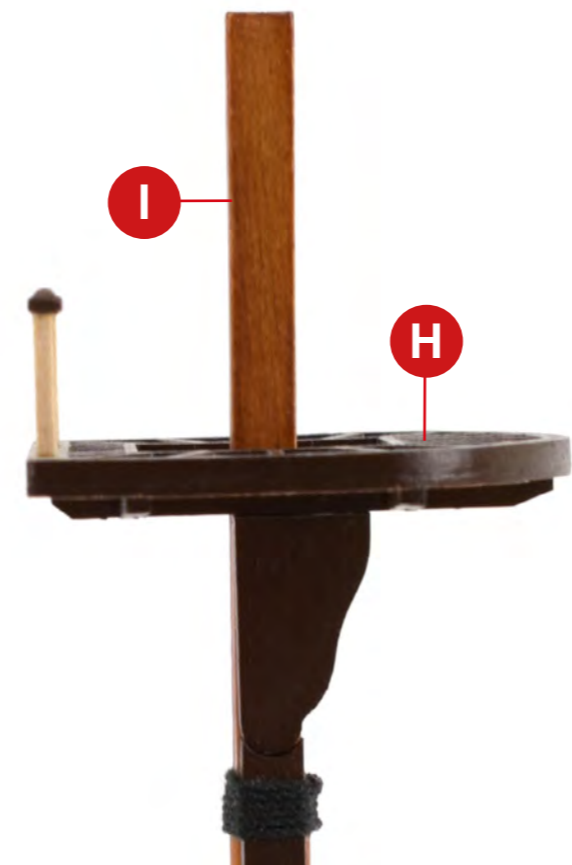

RIGHT VIEW



BOTTOM VIEW



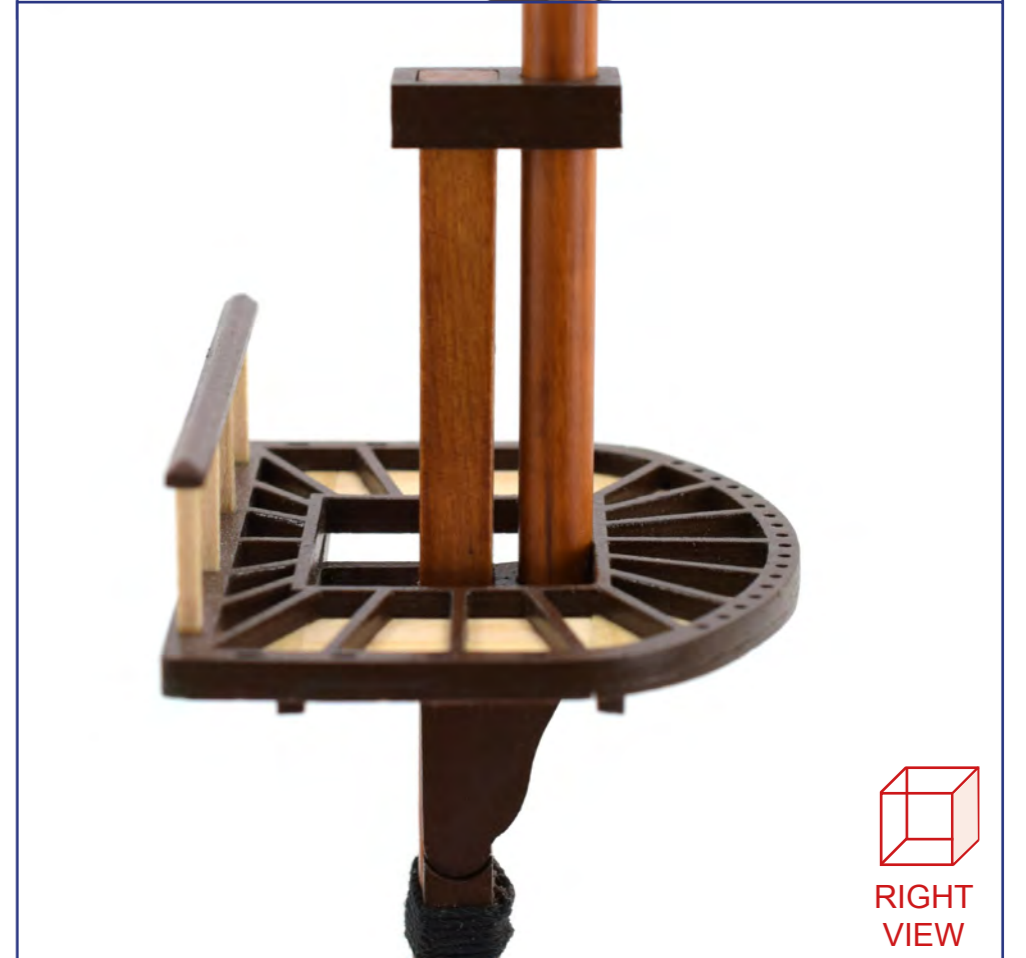
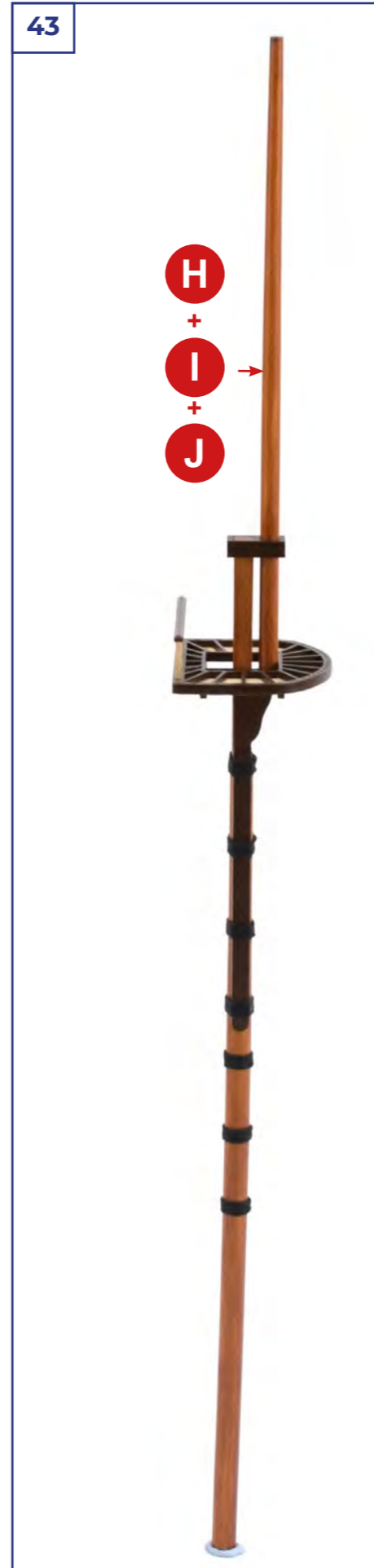
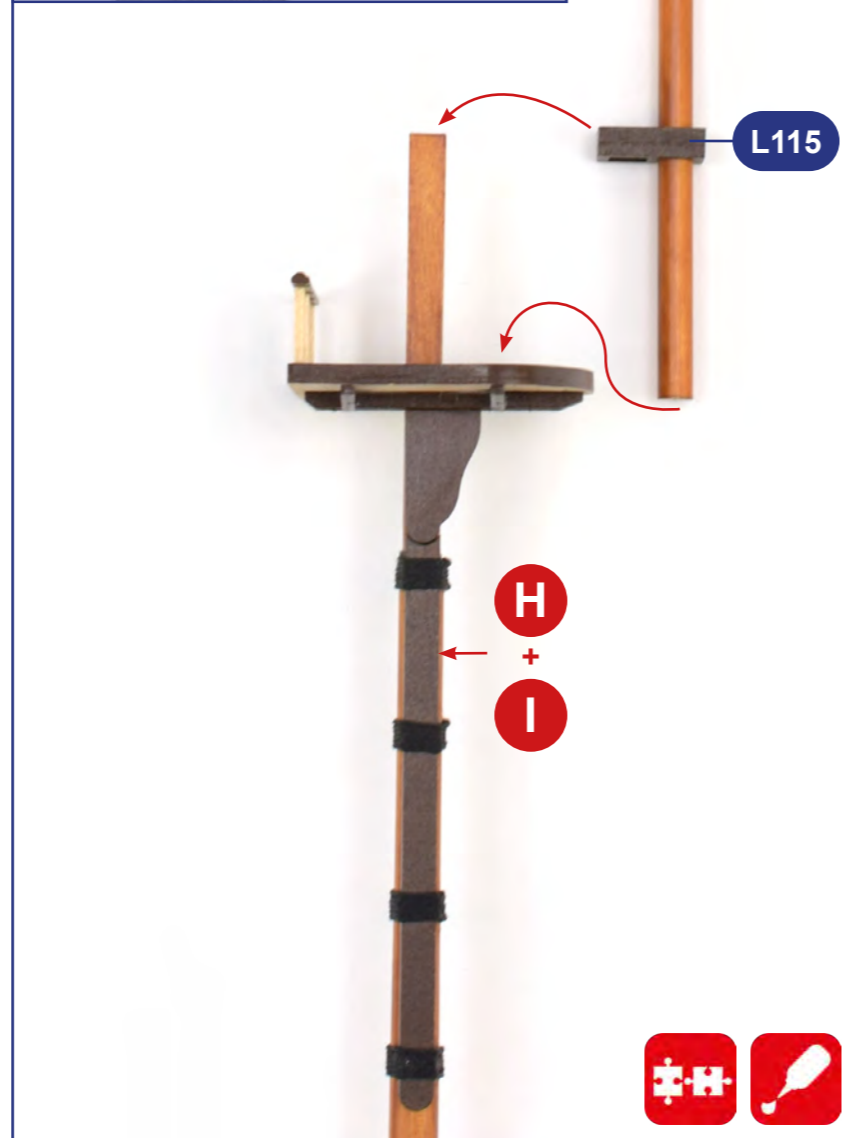
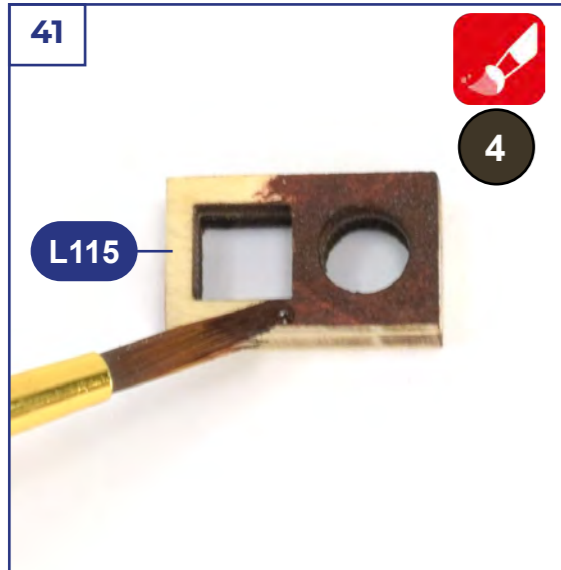
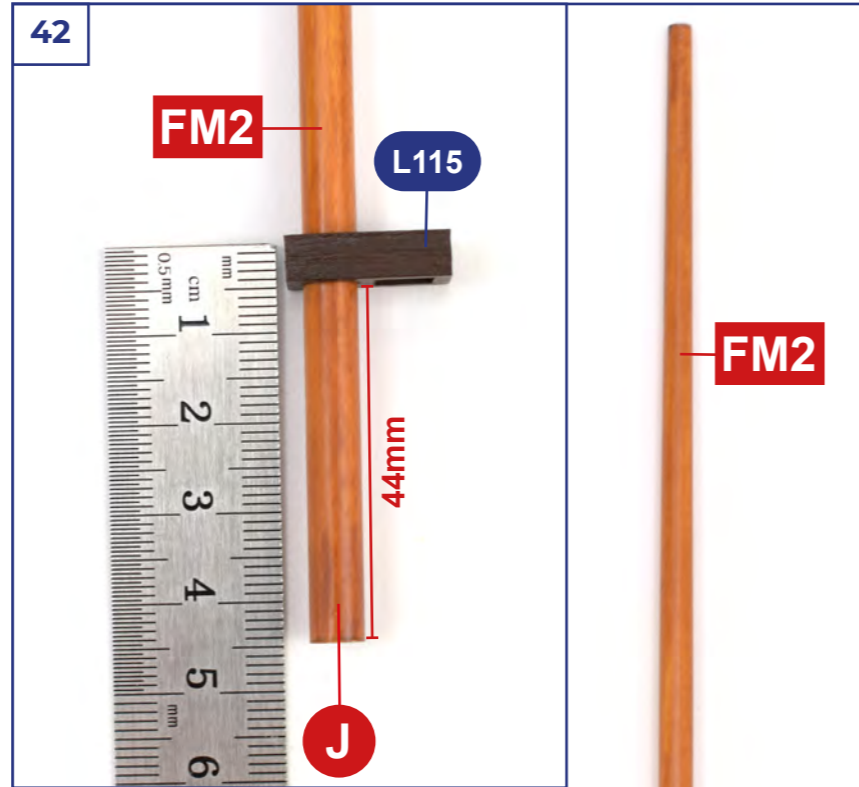
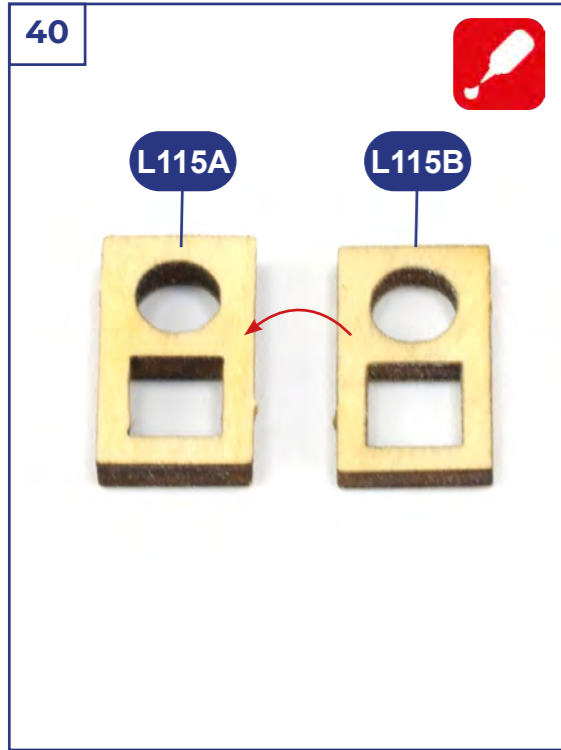

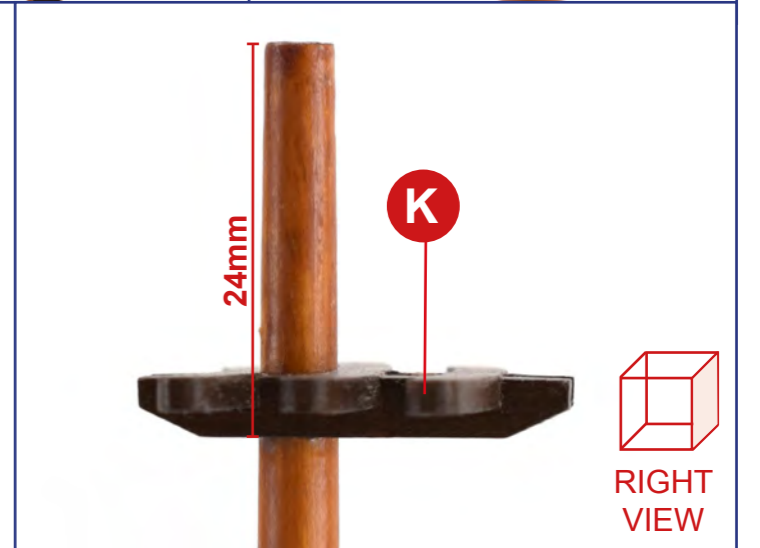
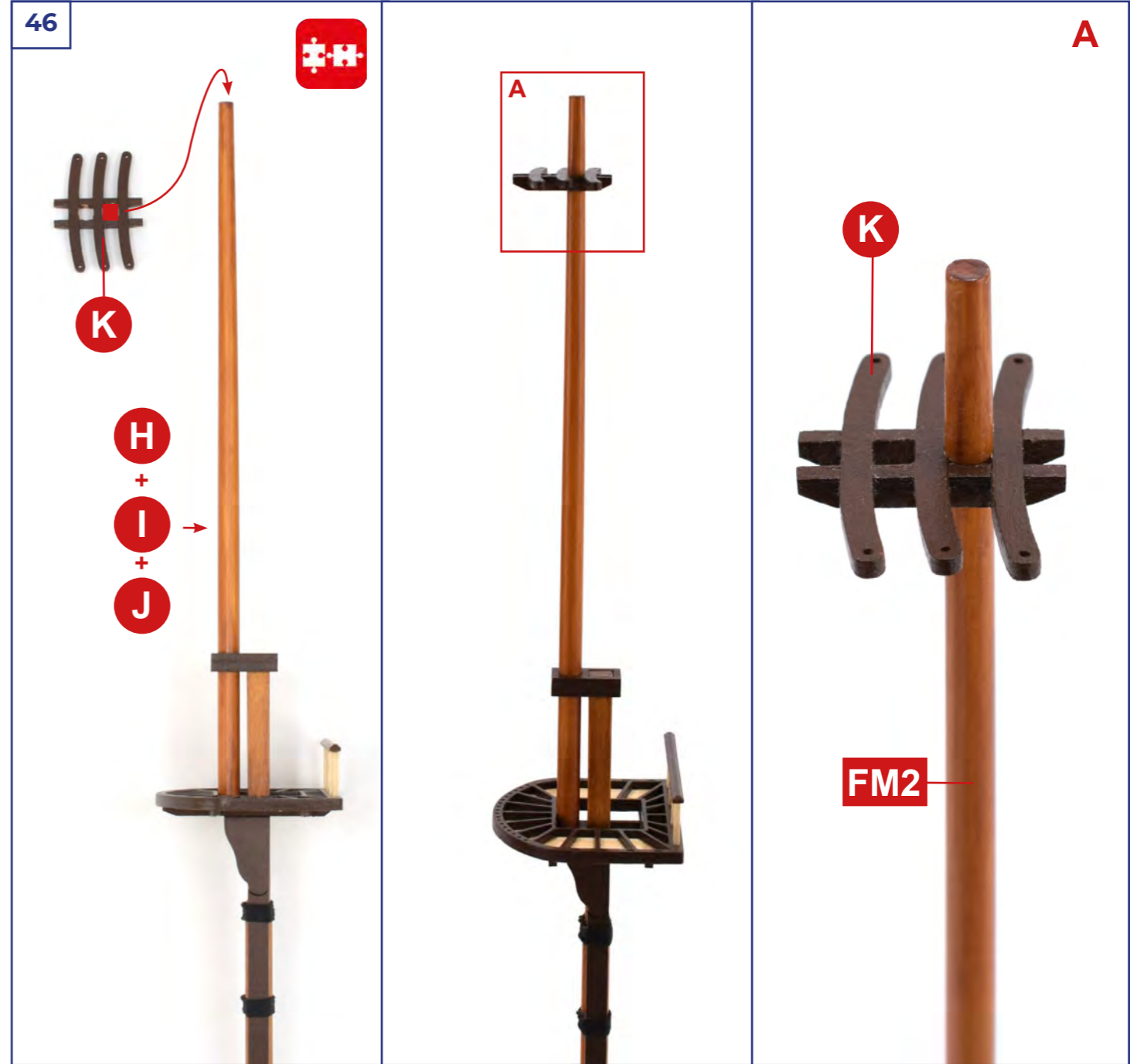
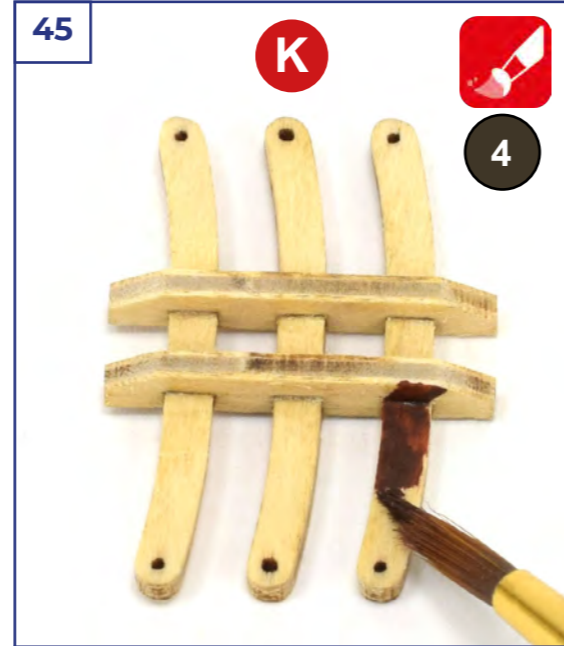
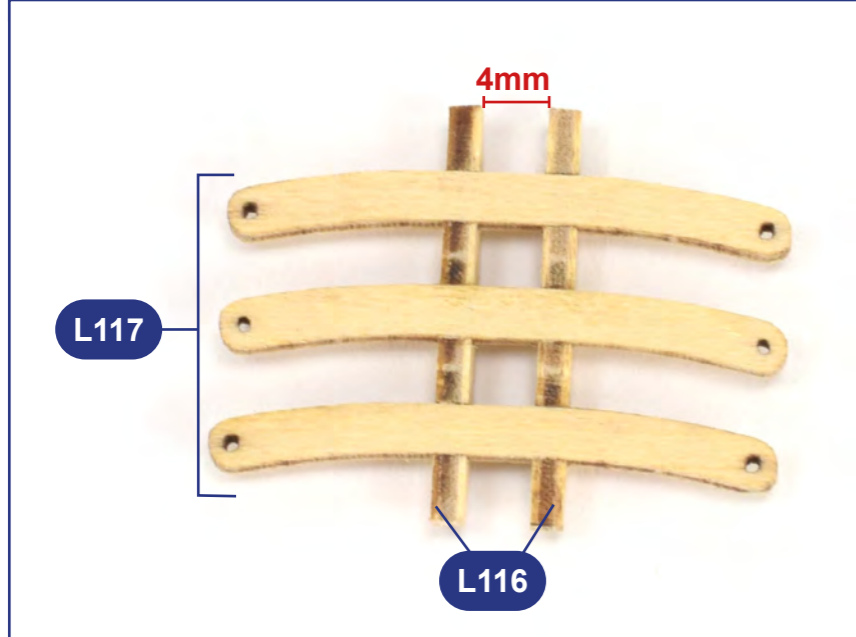
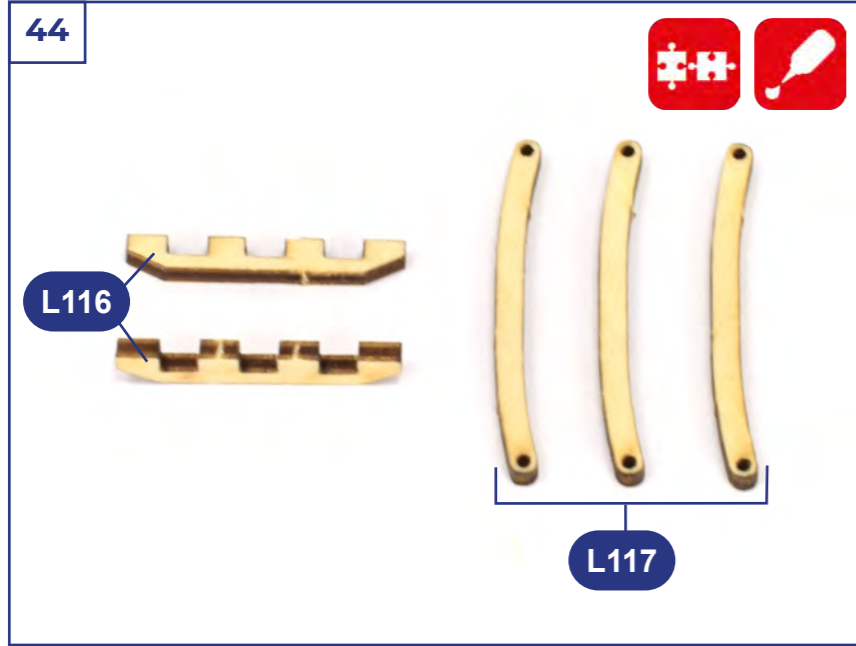

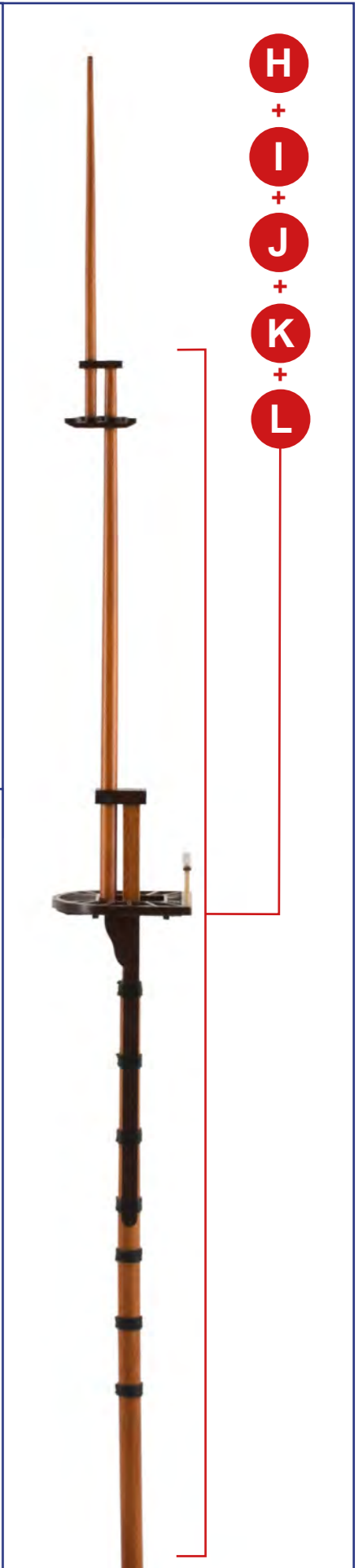
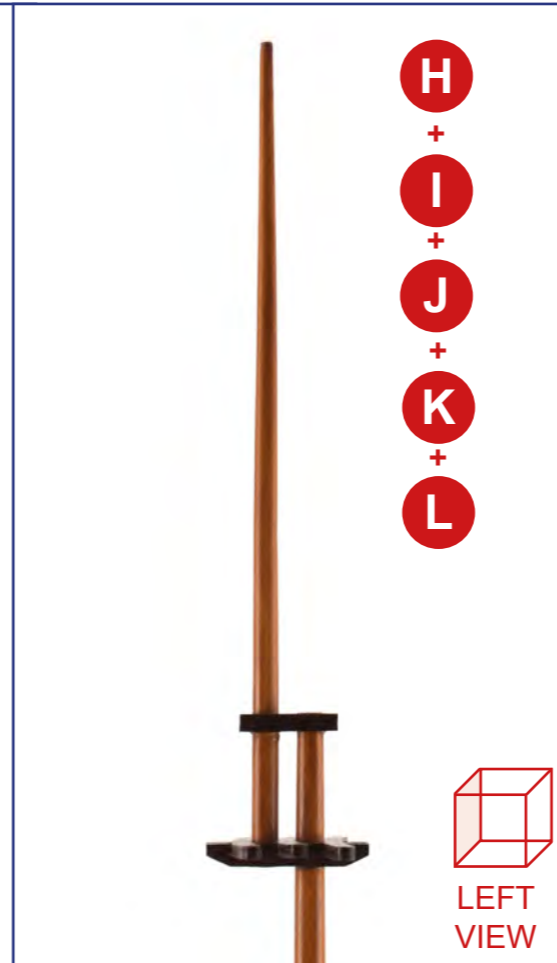
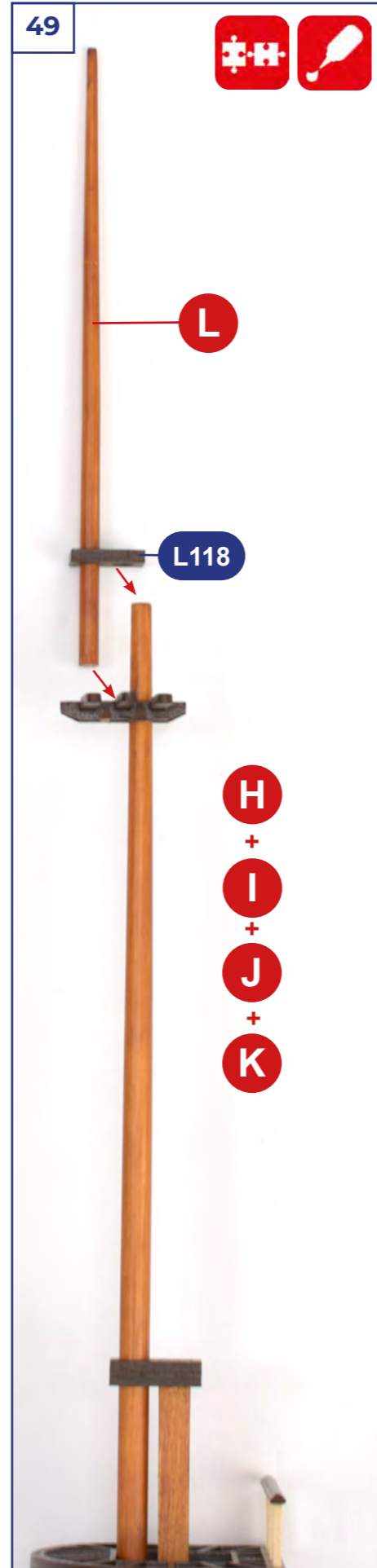
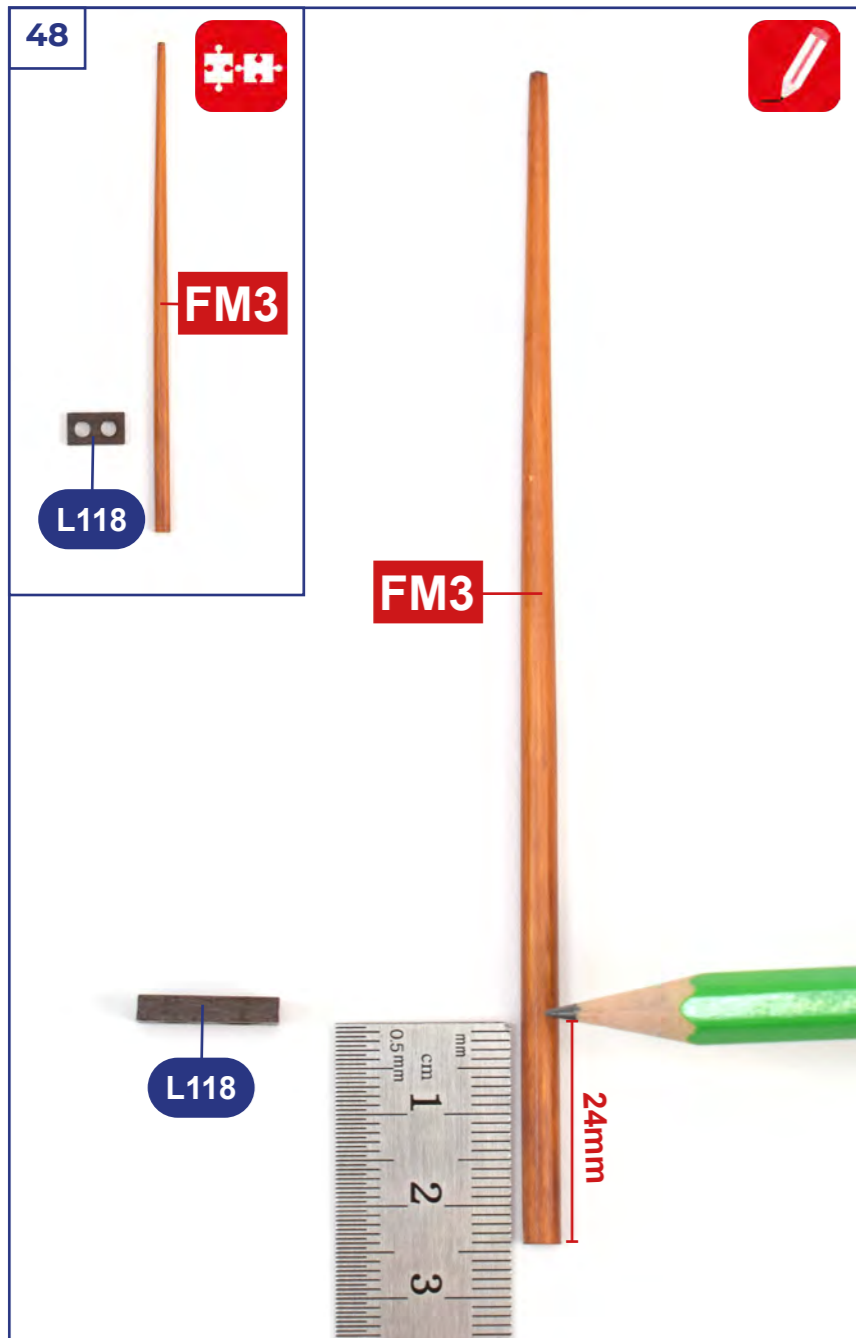
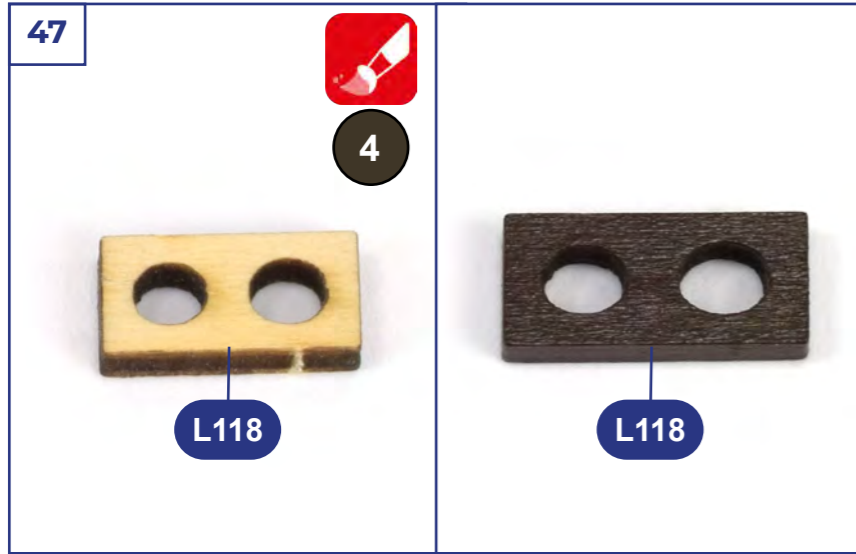

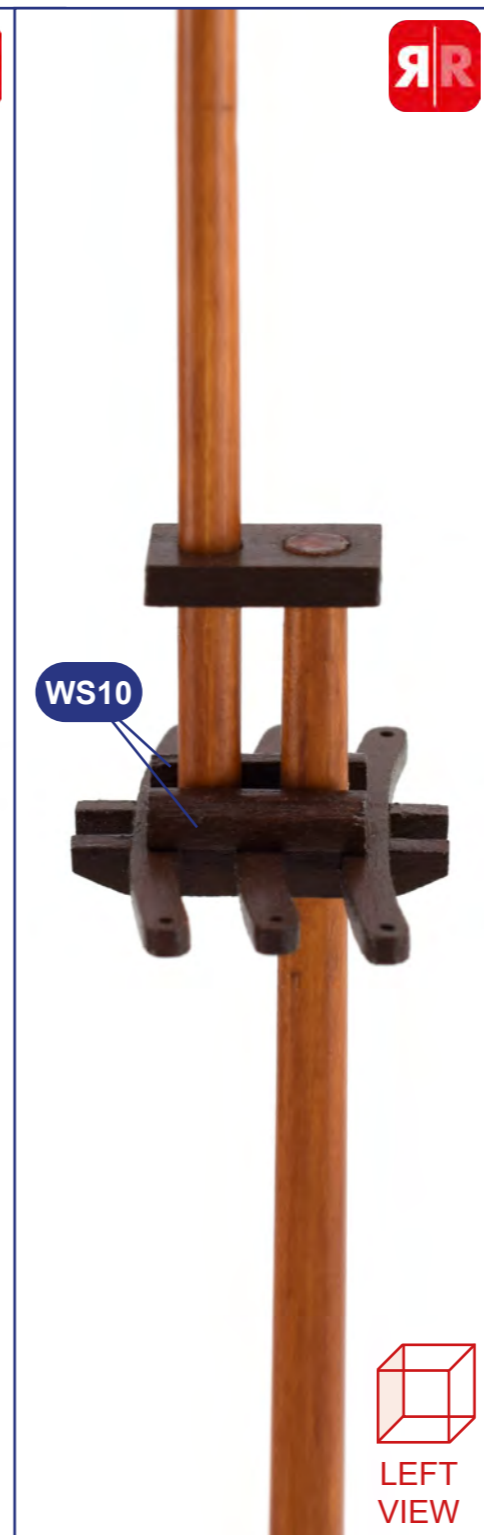
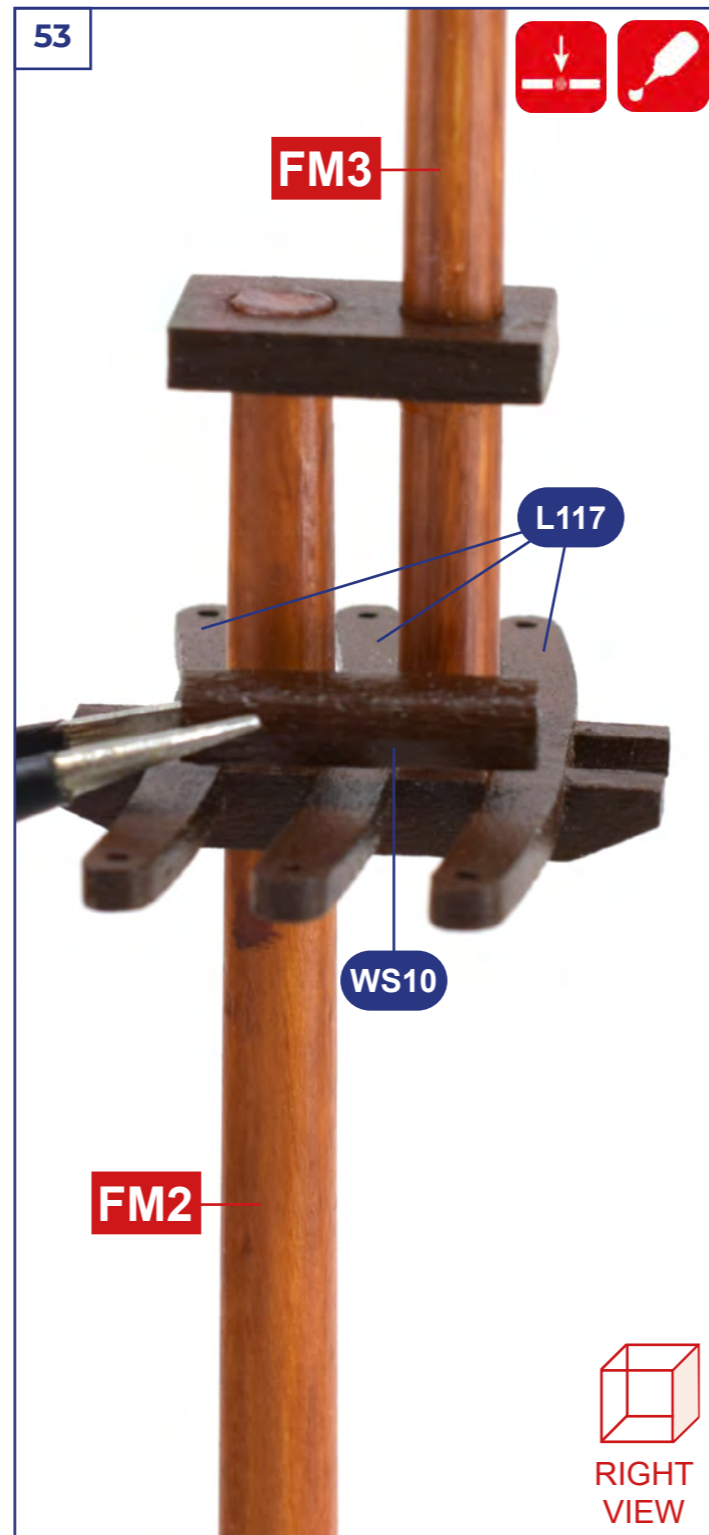
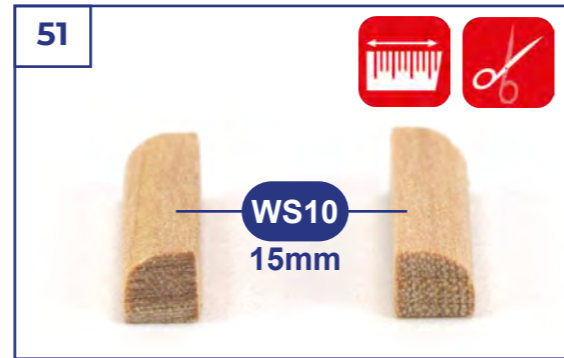
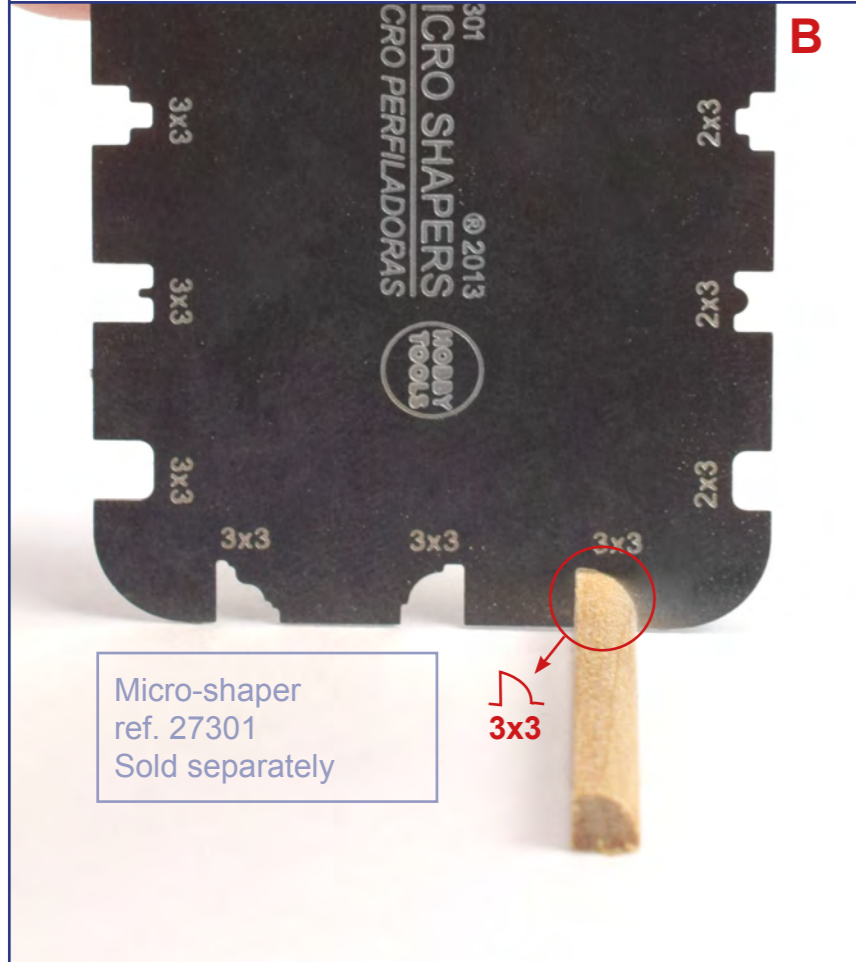
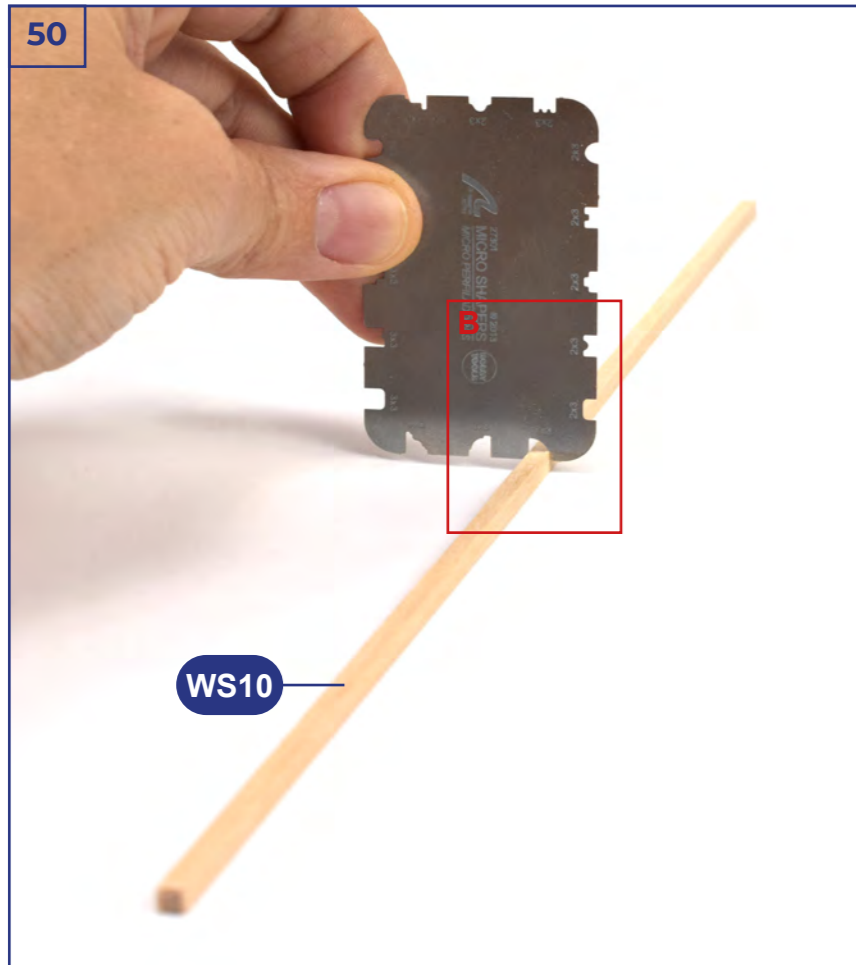

54

TRINQUETE- FOREMAST - MÂT DE MISAIN



LEFT VIEW



BACK VIEW

55



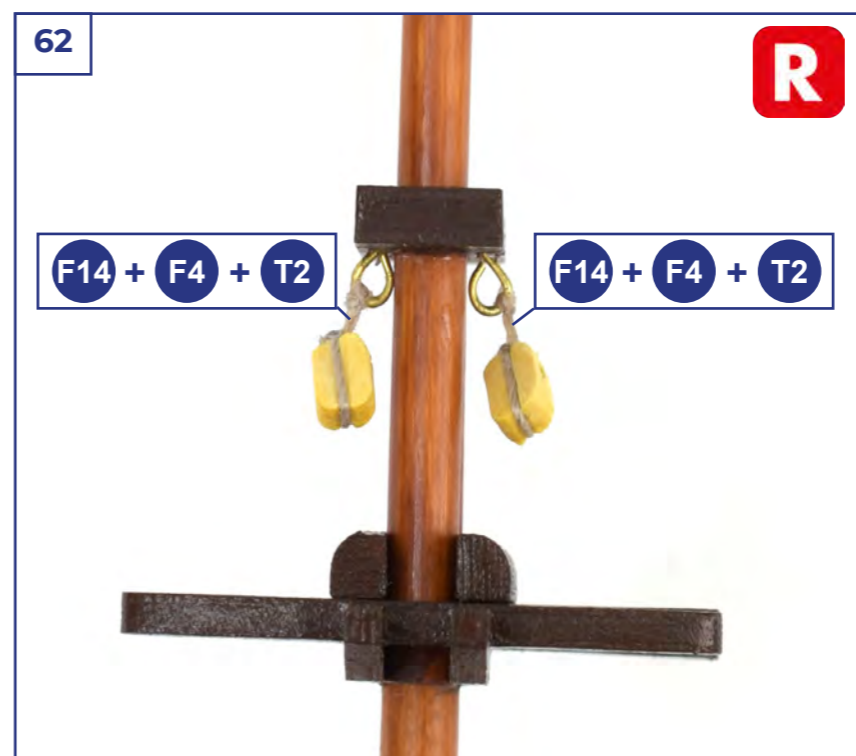
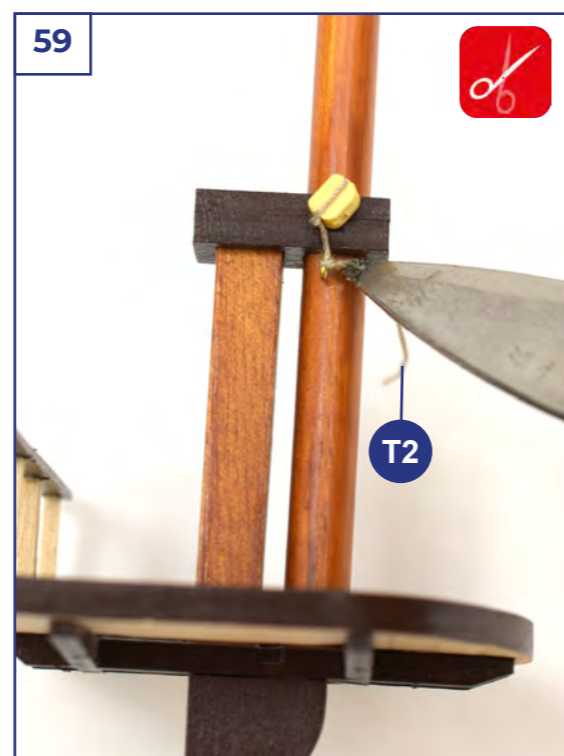
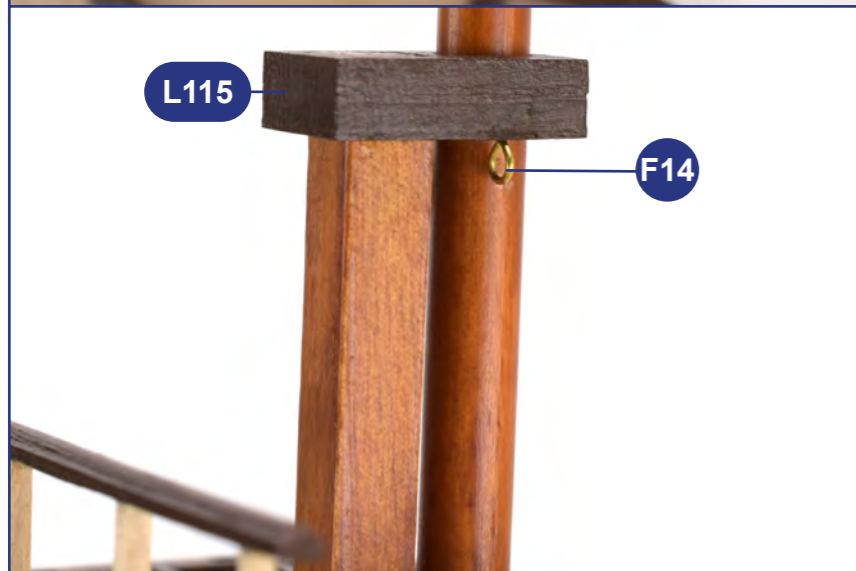
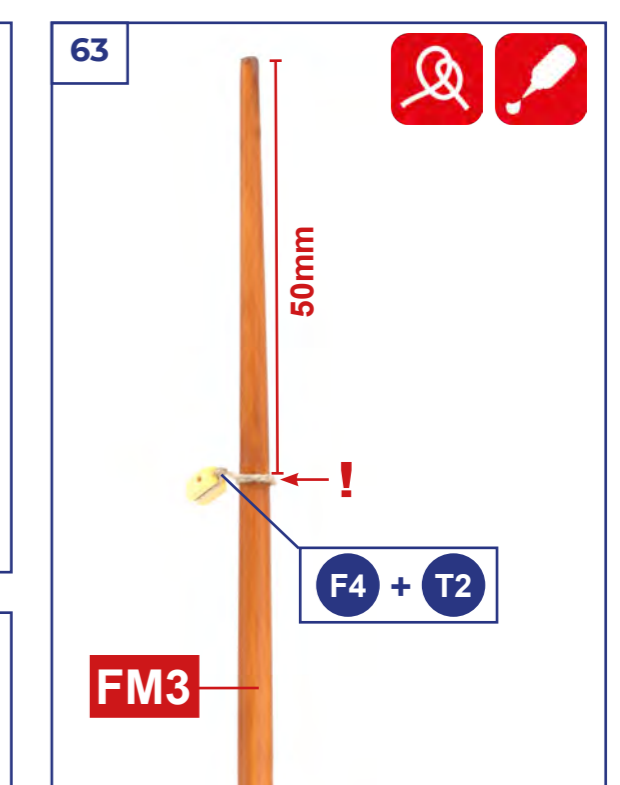
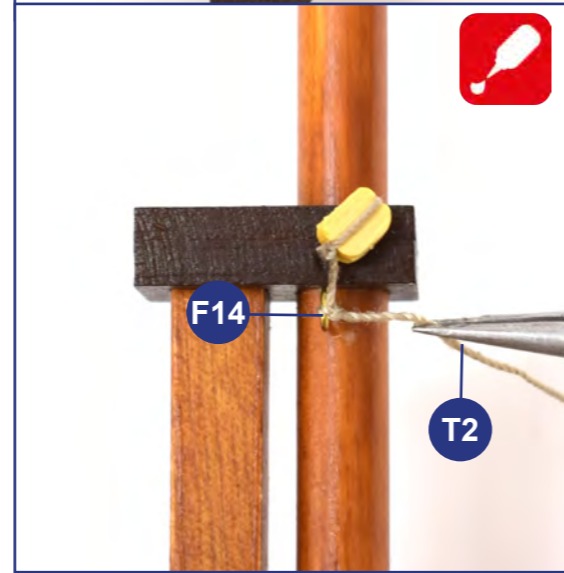
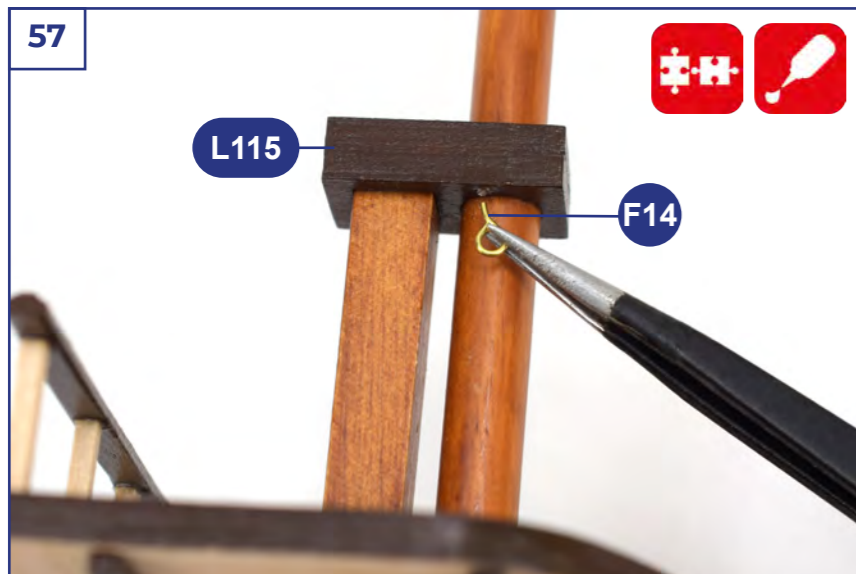
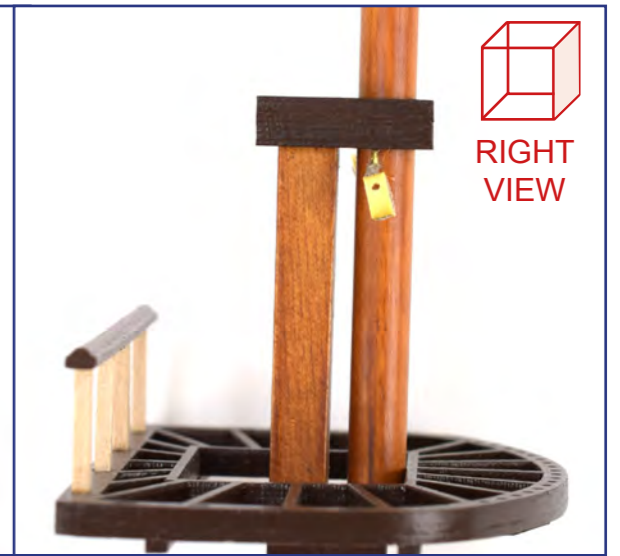
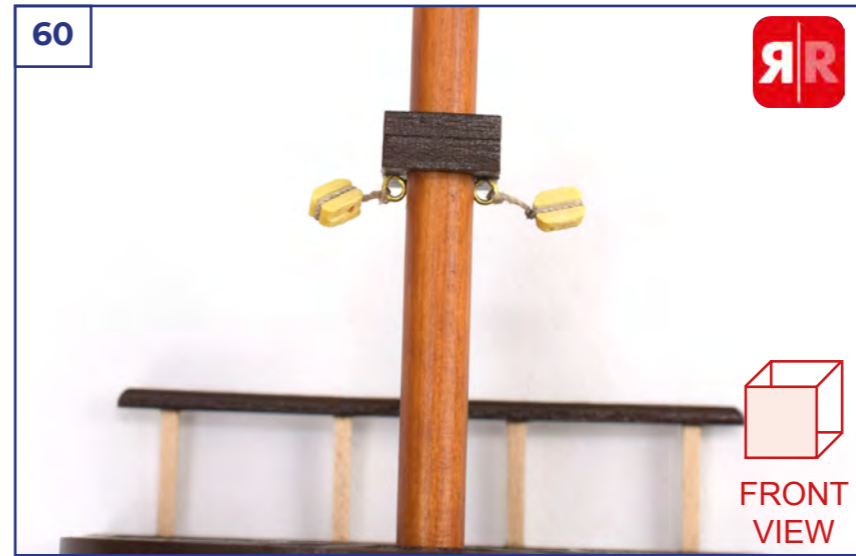
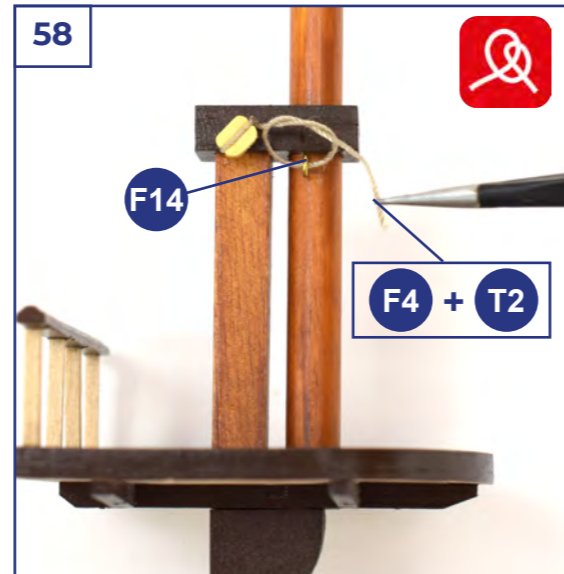
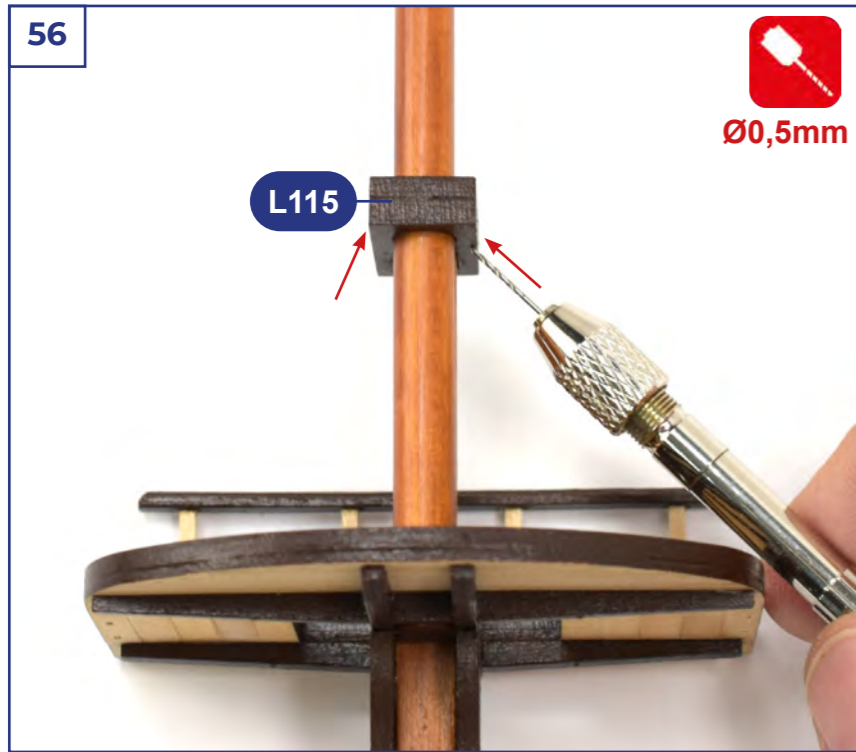

64

$\text{\O}4\text{mm}$ $\text{\O}6\text{mm}$ $\text{\O}4\text{mm}$
WD2 225mm
 $\text{\O}3\text{mm}$ $\text{\O}4\text{mm}$ $\text{\O}3\text{mm}$
WD4 190mm
 $\text{\O}2\text{mm}$ $\text{\O}4\text{mm}$ $\text{\O}2\text{mm}$
WD1 150mm

6

Y5 WD2
Y6 WD4
Y7 WD1

65

Micro-shaper ref. 27304 Sold separately

WS11

WS11

1x3

66

Y5

WS7 56mm x8 1,5x4

Y6

WS11 48mm x8 1x3



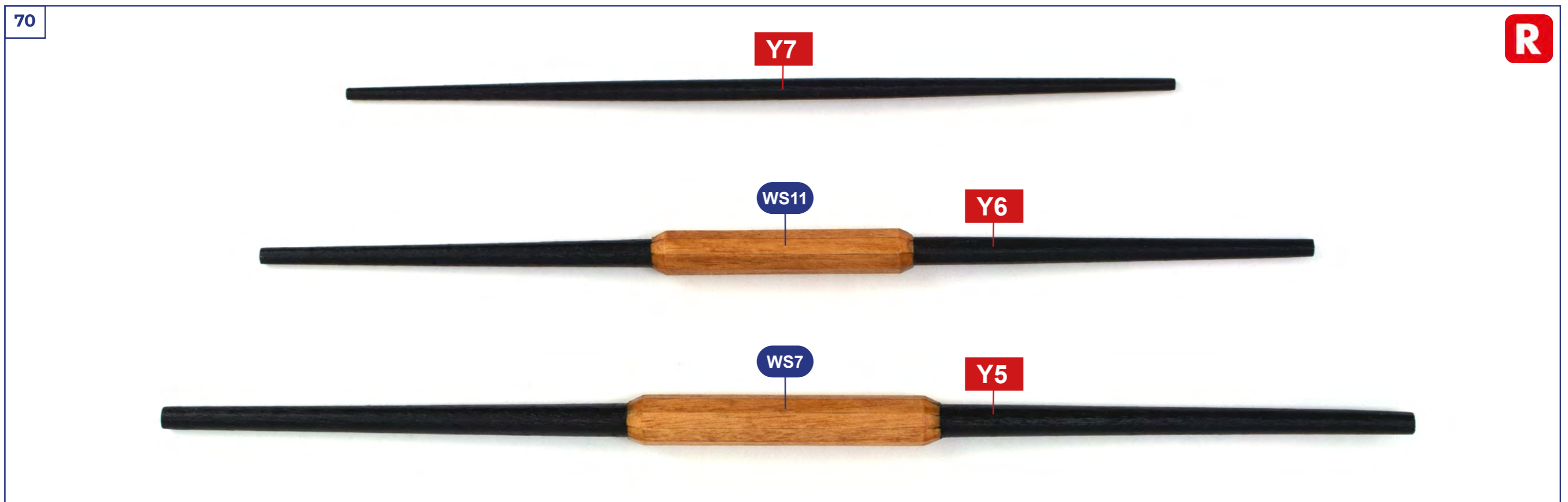
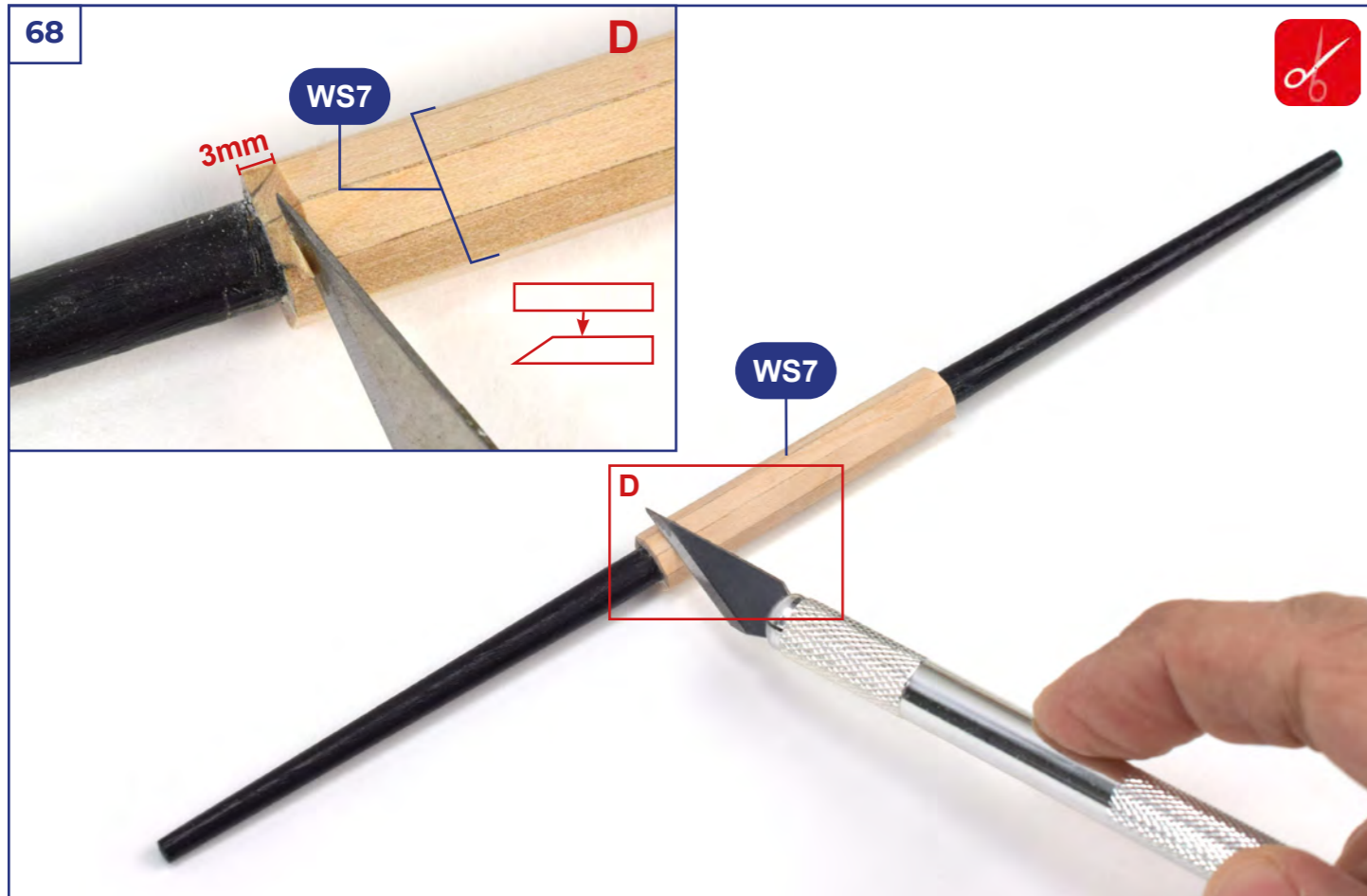

01 BAUPRÉS- BOWSPRIT - BAUPRÉS 11

WD3 185mm Ø8mm
 WD2 190mm Ø6mm
 WD5 70mm Ø3mm

BP1, BP2, BP3

Ø7mm, Ø4mm, Ø2mm

02 WS10 20mm

WS10 20mm

03 WS9 5mm

WS9 5mm

04 4

L120, WS9, WS10, L121, L122, L119A + L119B

05 6

Ø2mm, WD1, Y2, Ø4mm, Y1, Ø2mm, Ø3mm, WD4, Ø5mm, Ø3mm

06

L120, BP2, L121, WS10, BP1, L122

LEFT VIEW, TOP VIEW

07 BOWSPRIT A

BOWSPRIT, L121, WS9

34mm, 7mm, 65mm, 92mm

TOP VIEW

07 A

L122, BP1, WS9

08 B

F14, F4, T2, L121

LEFT VIEW

08 B

L122

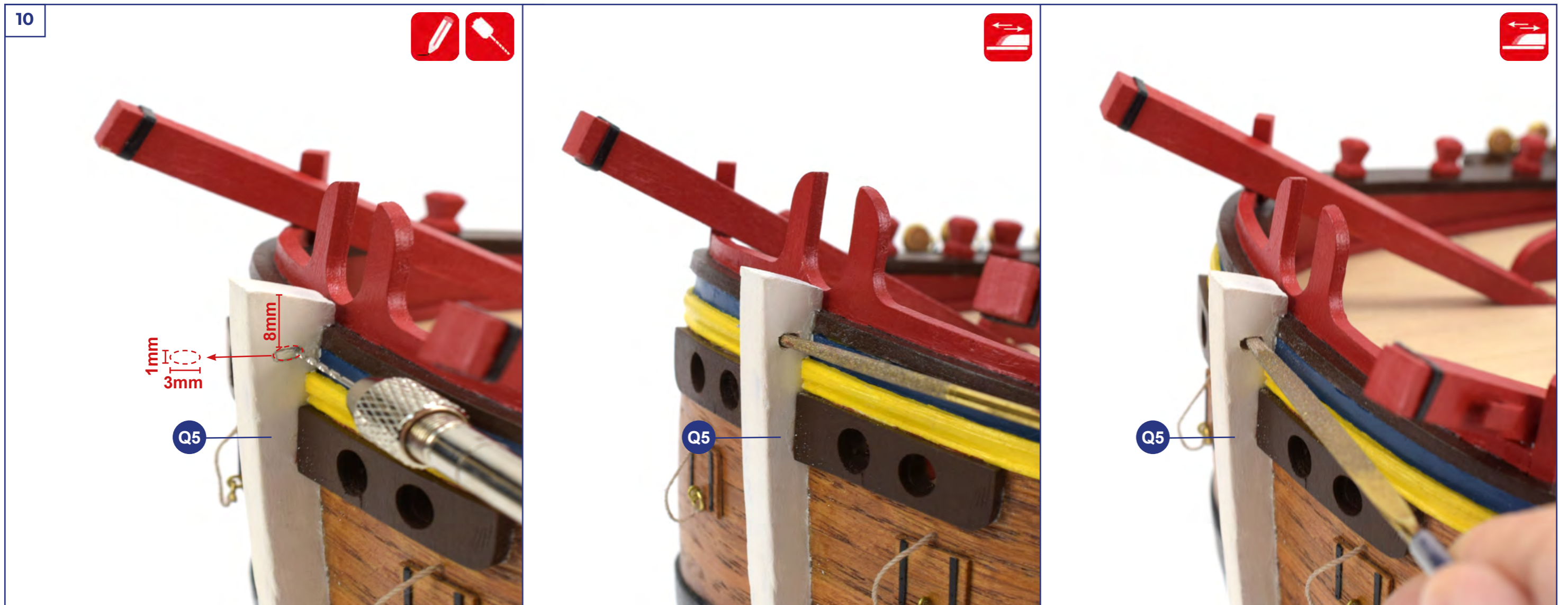

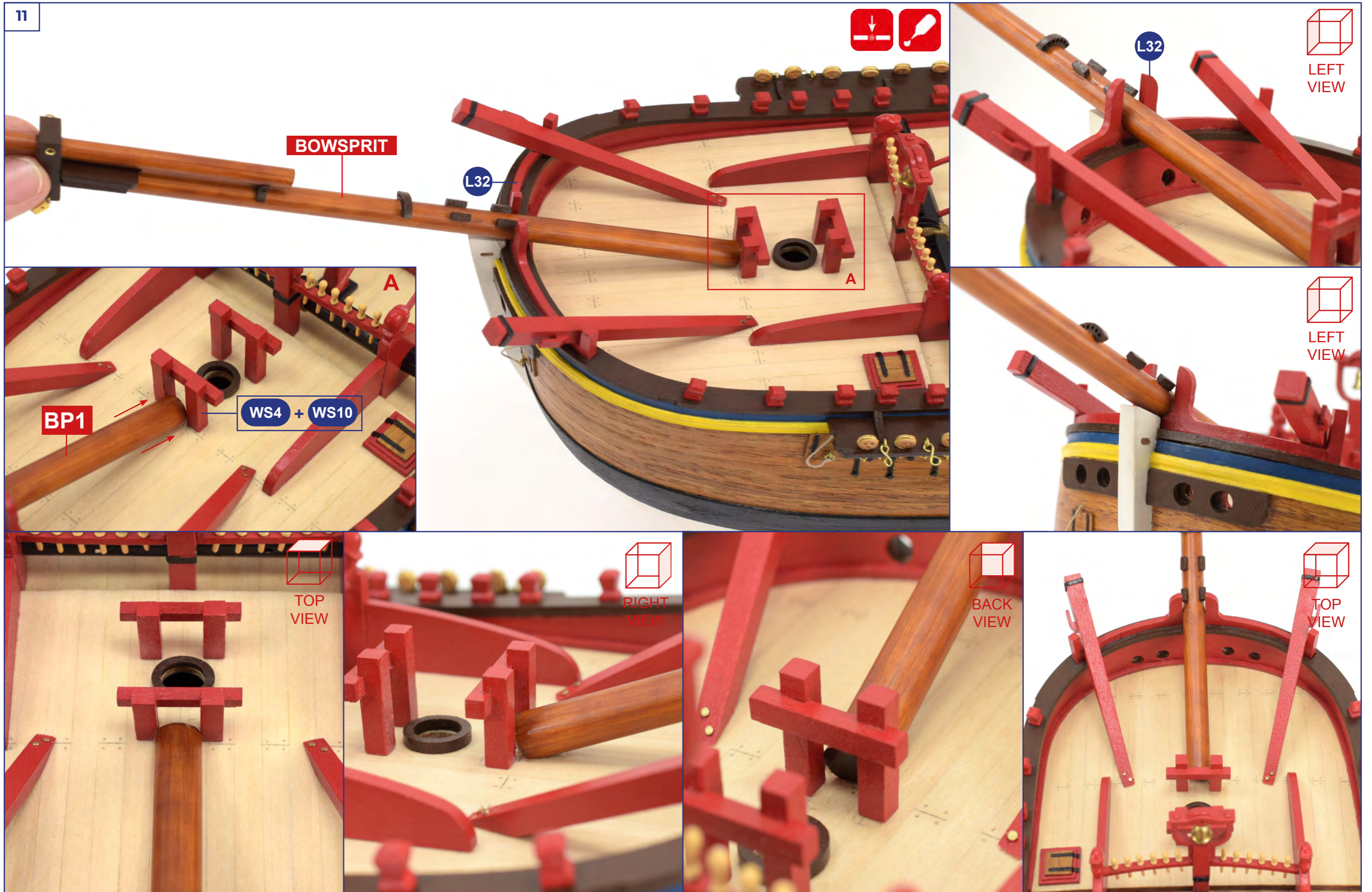

12



01



02

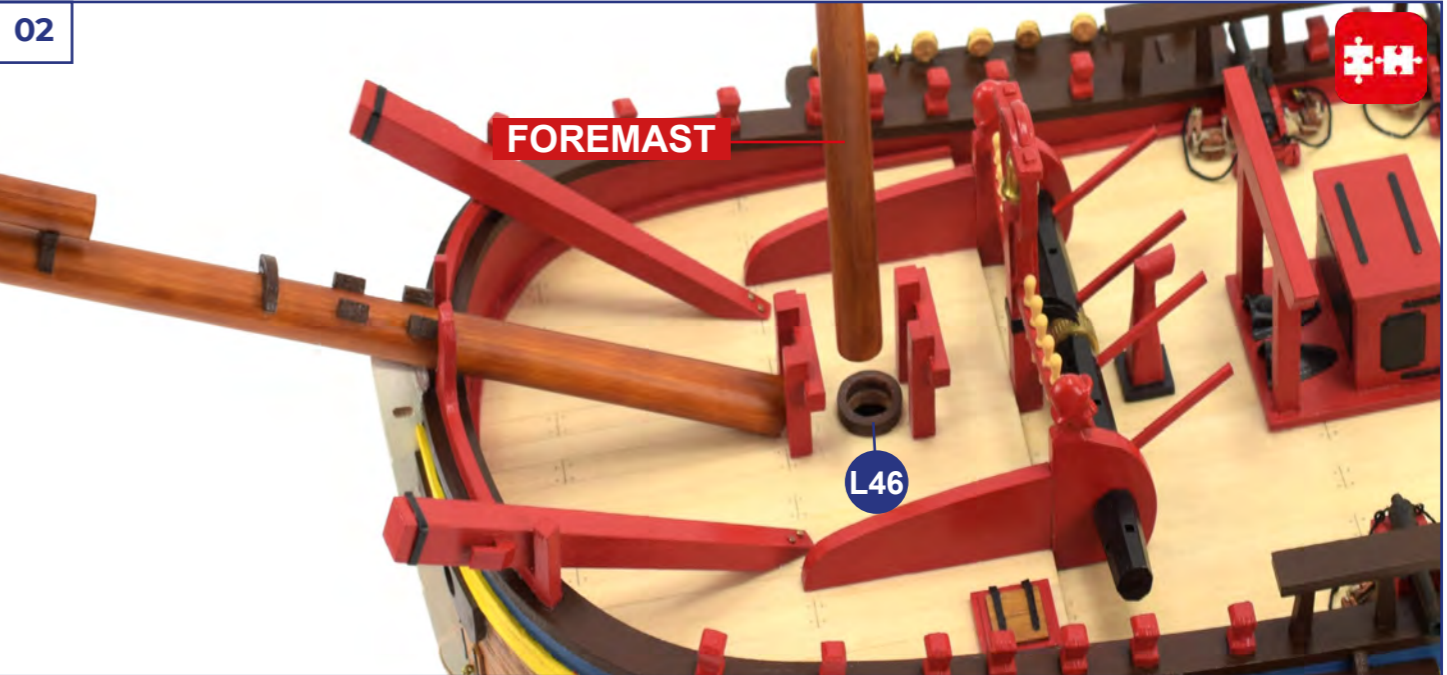

03



LEFT VIEW



FRONT VIEW

01

R

PALO MAYOR- MAIN MAST - GRAN MÂT

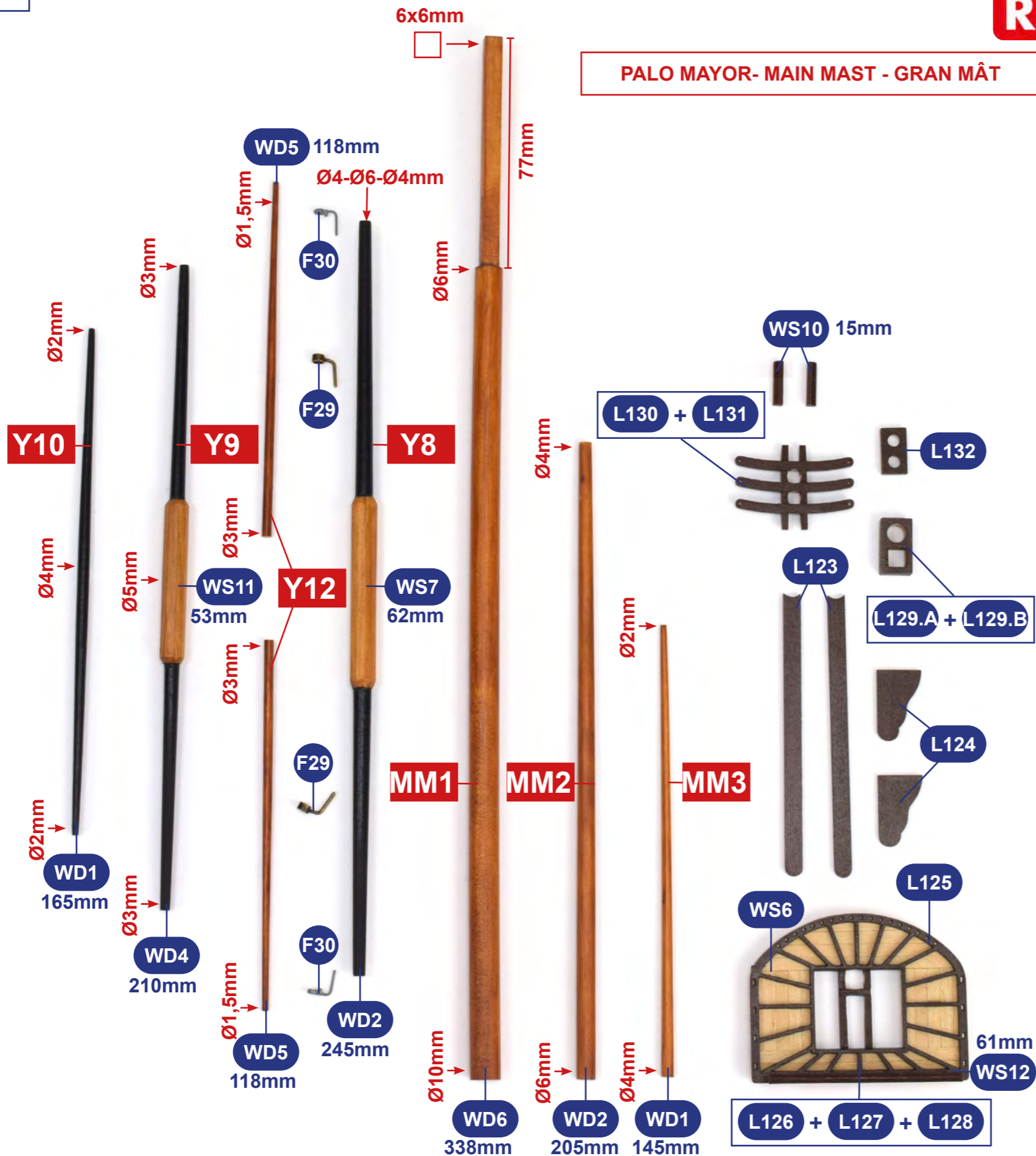

02

+ **+**

MAIN MAST

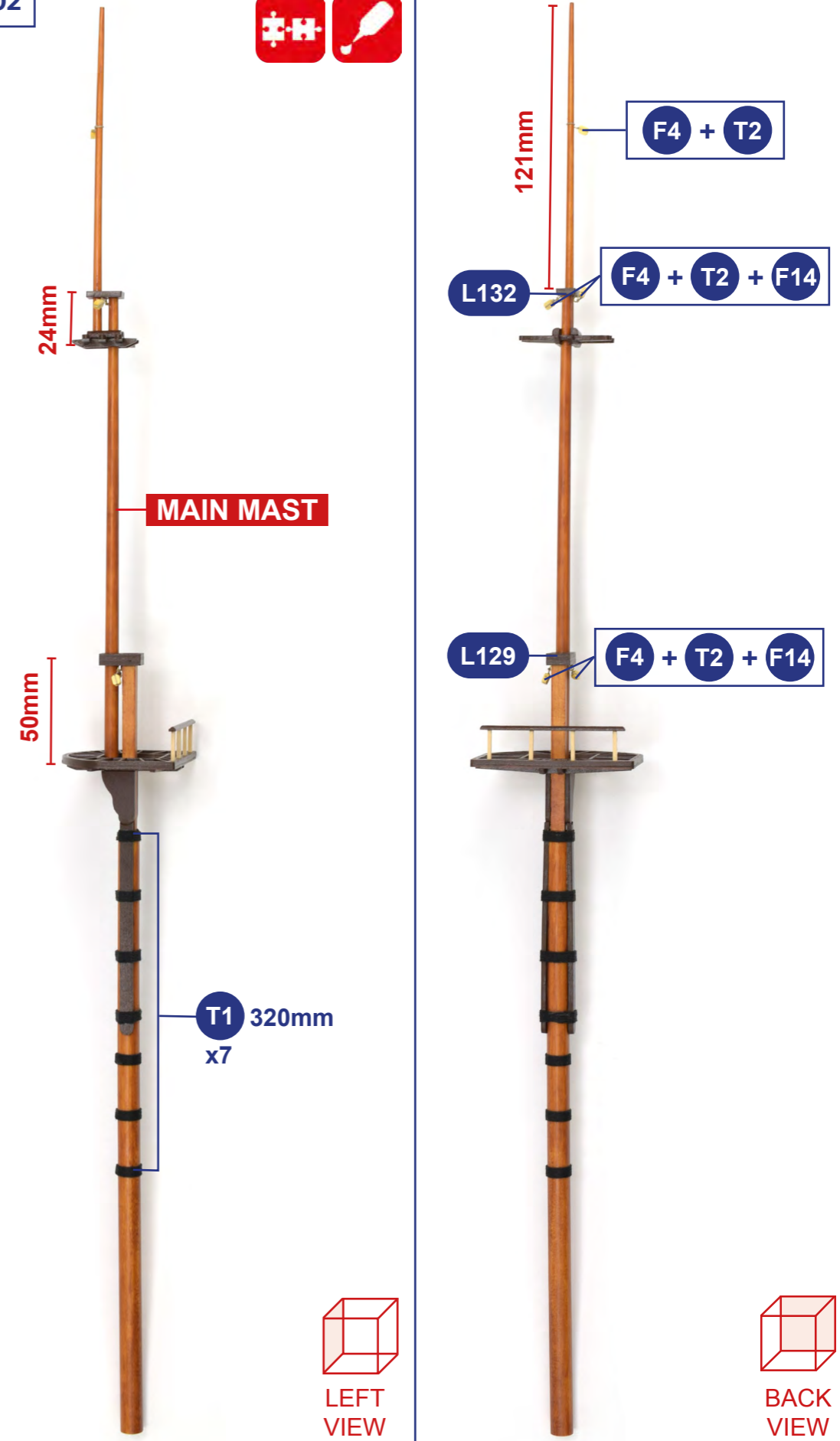

LEFT VIEW

BACK VIEW

03

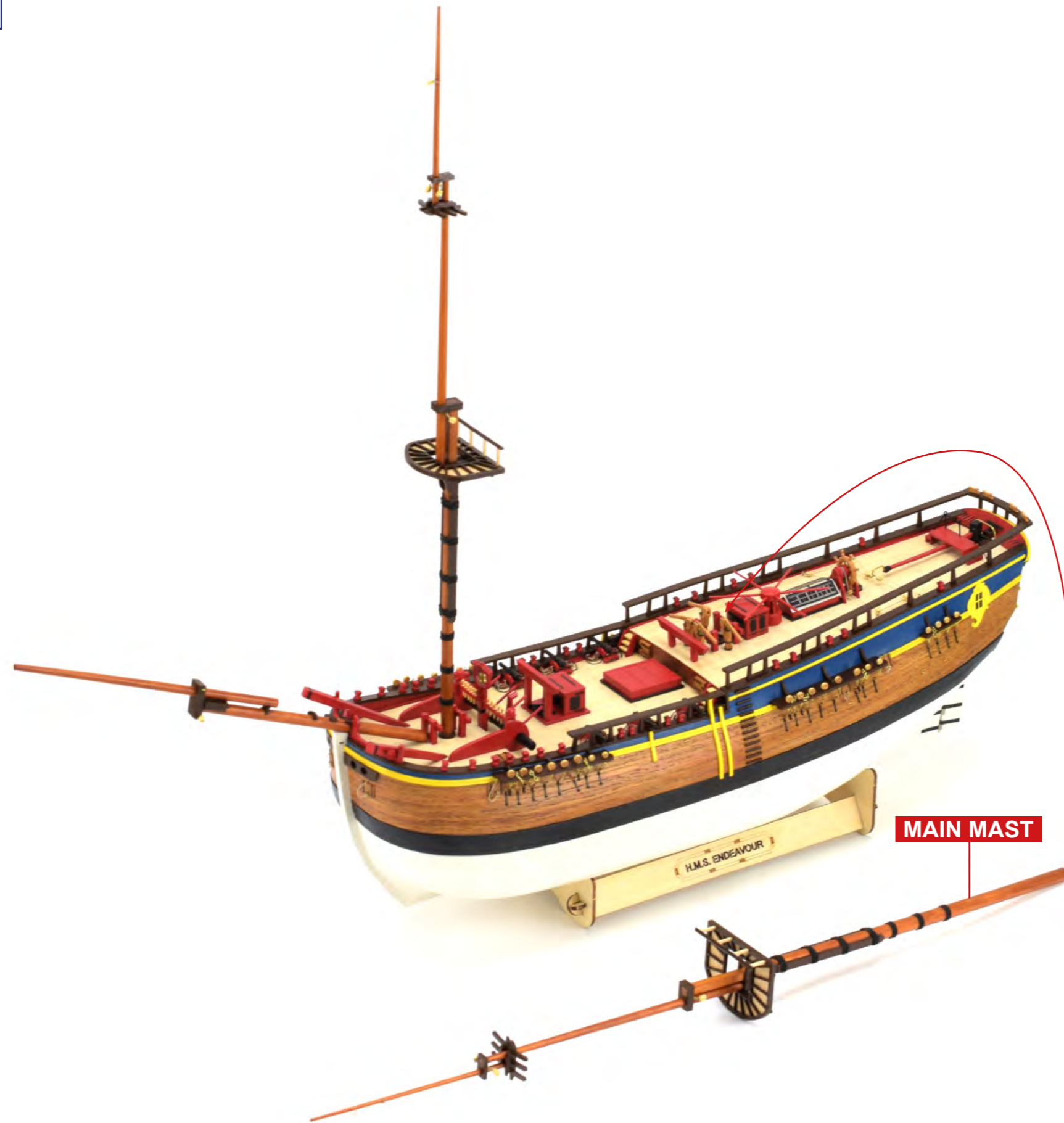

04

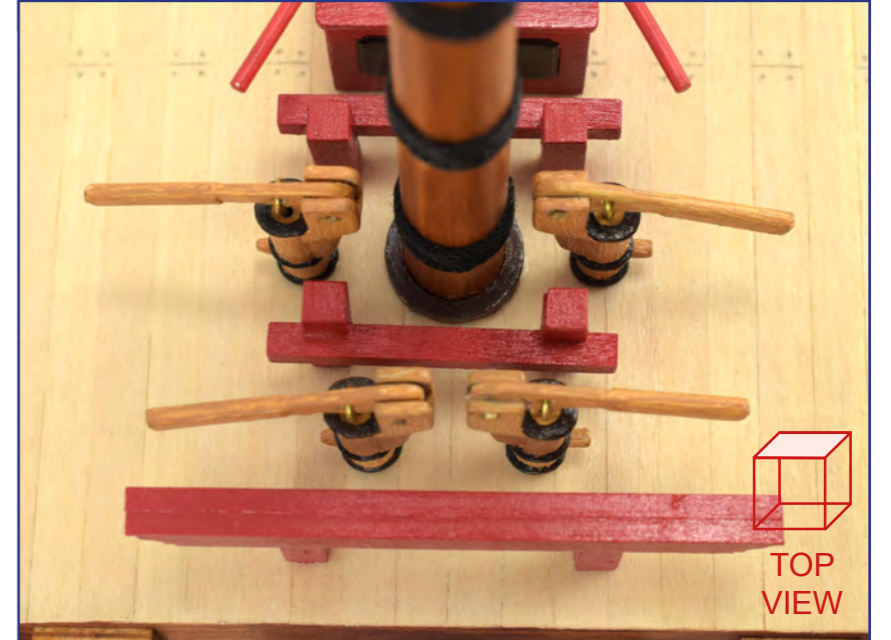

05

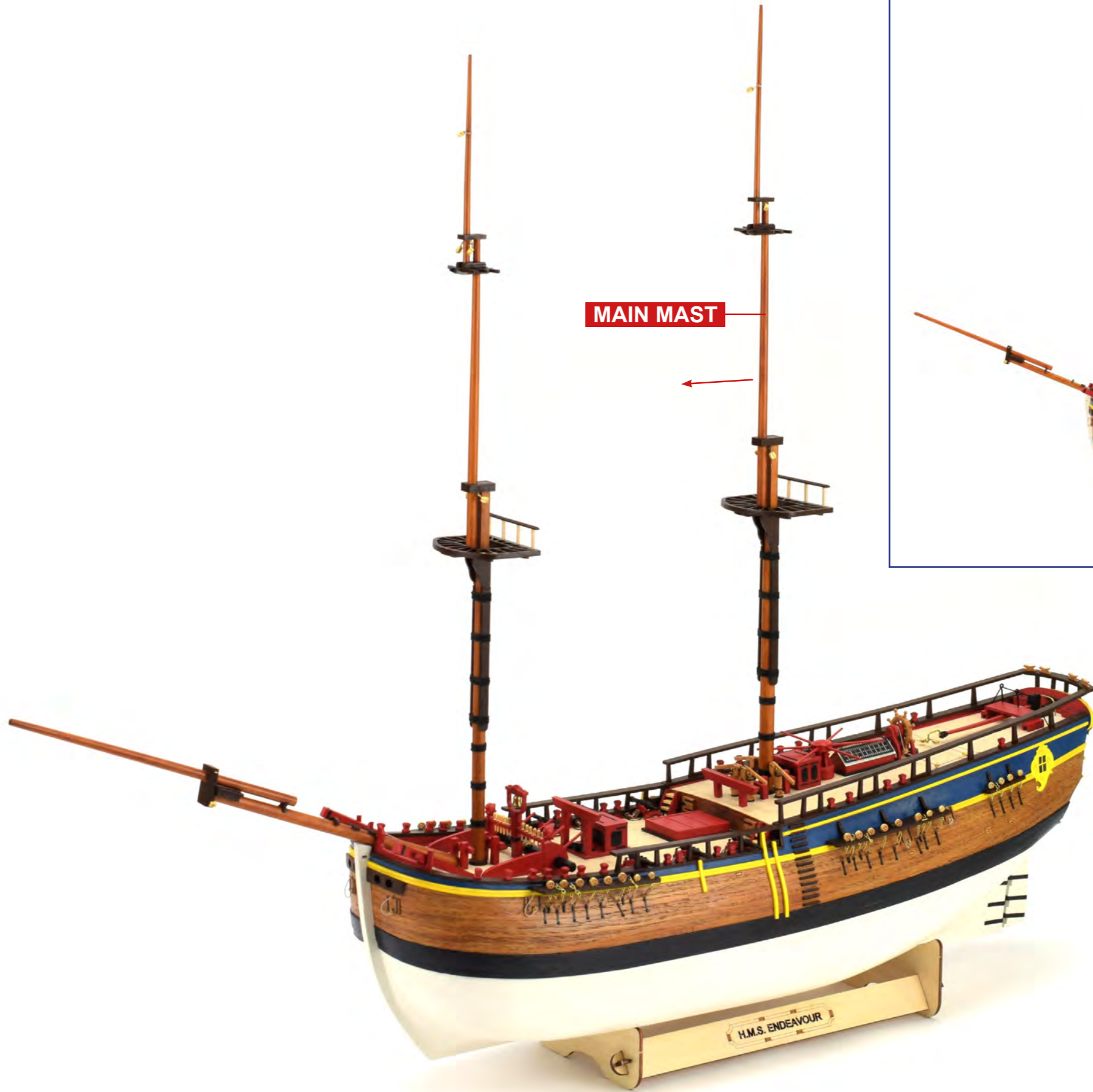

MAIN MAST



LEFT VIEW

01

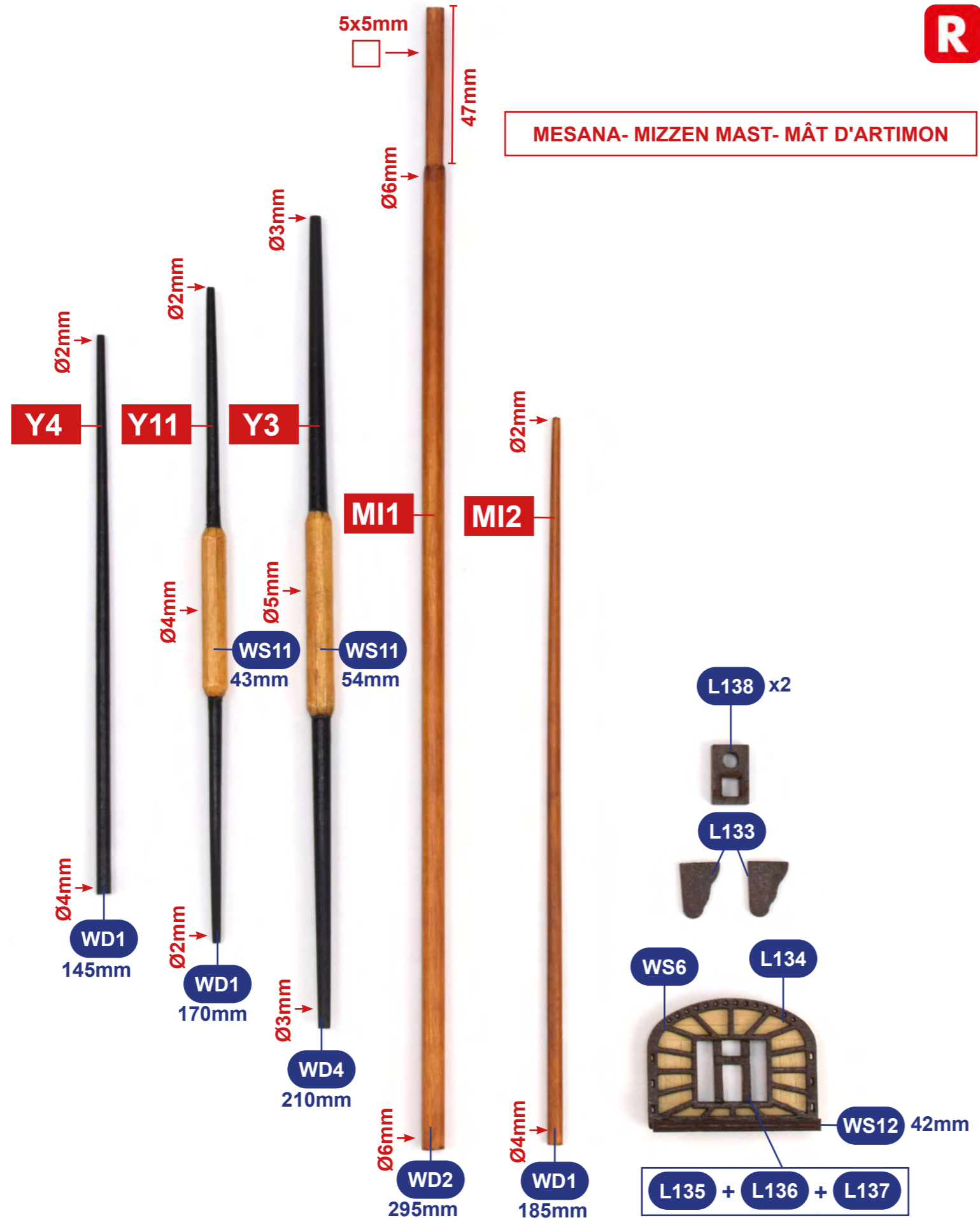

02

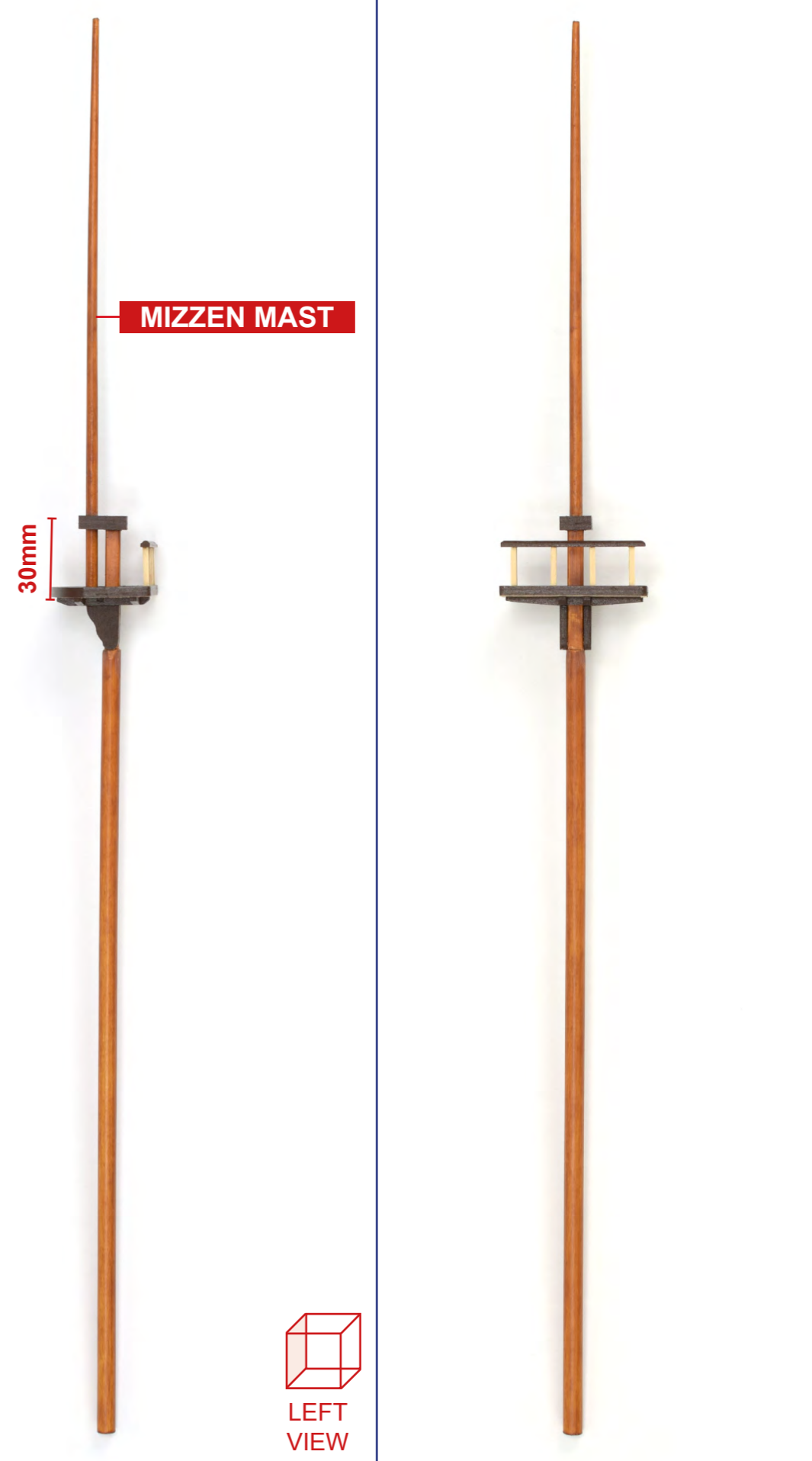

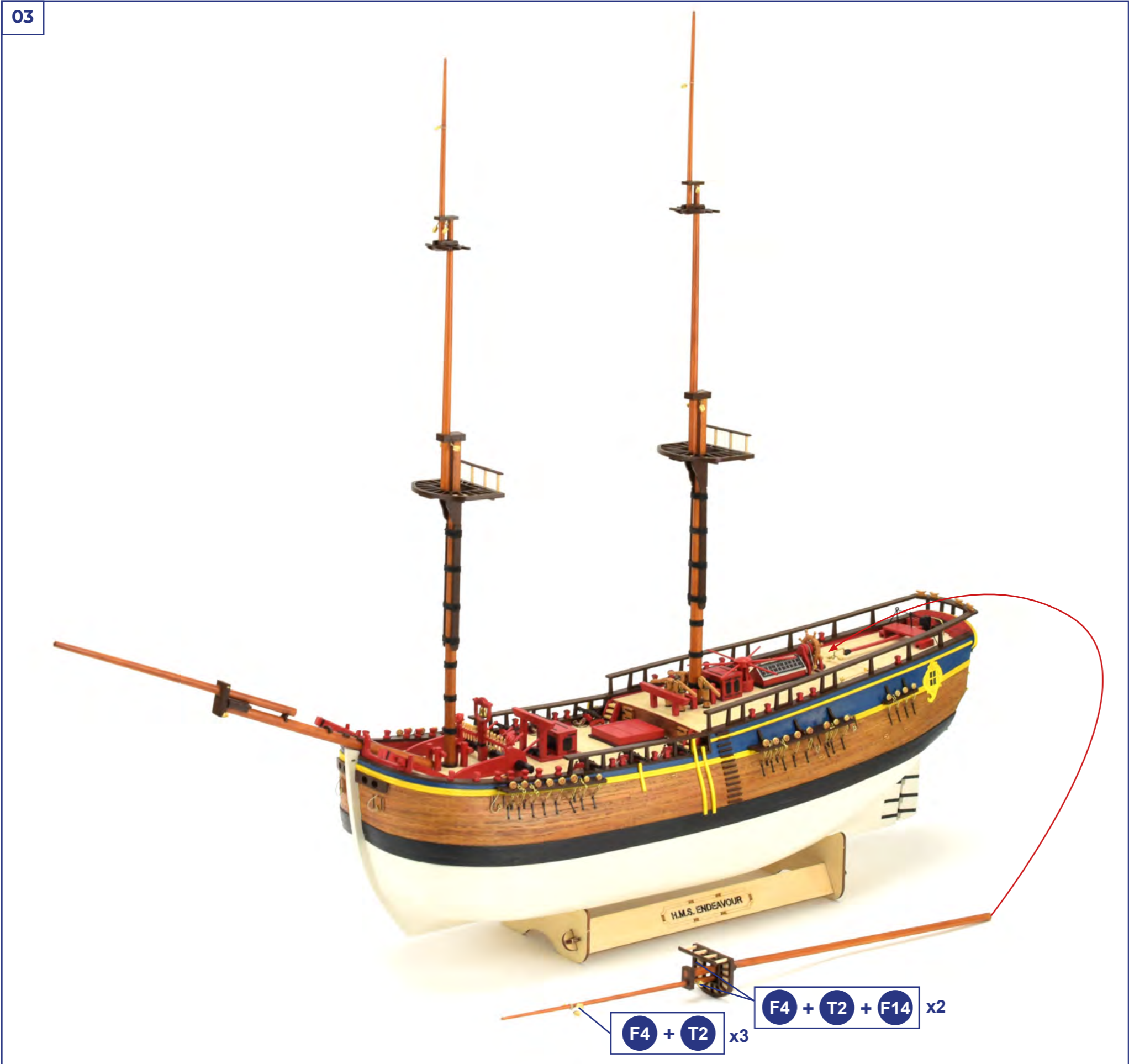

05

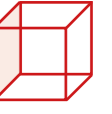

LEFT
VIEW

MIZZEN MAST

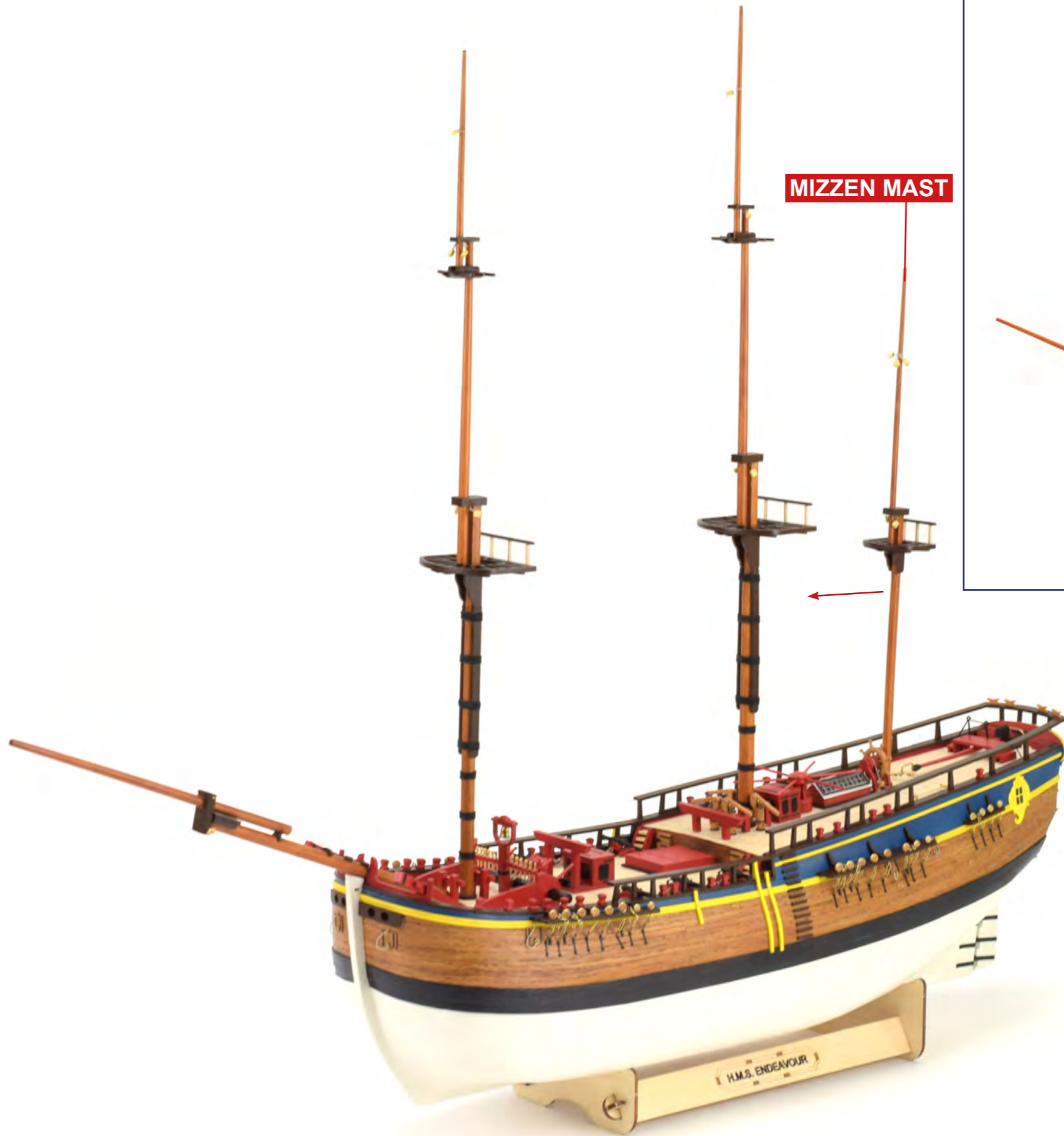

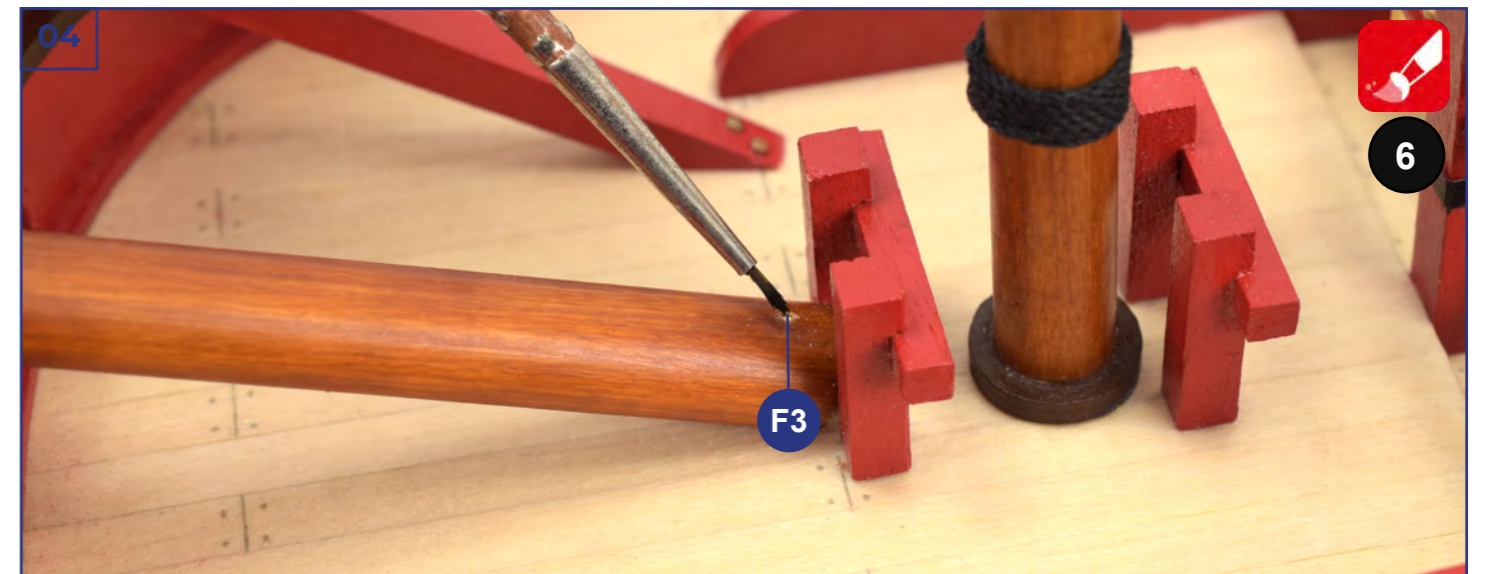
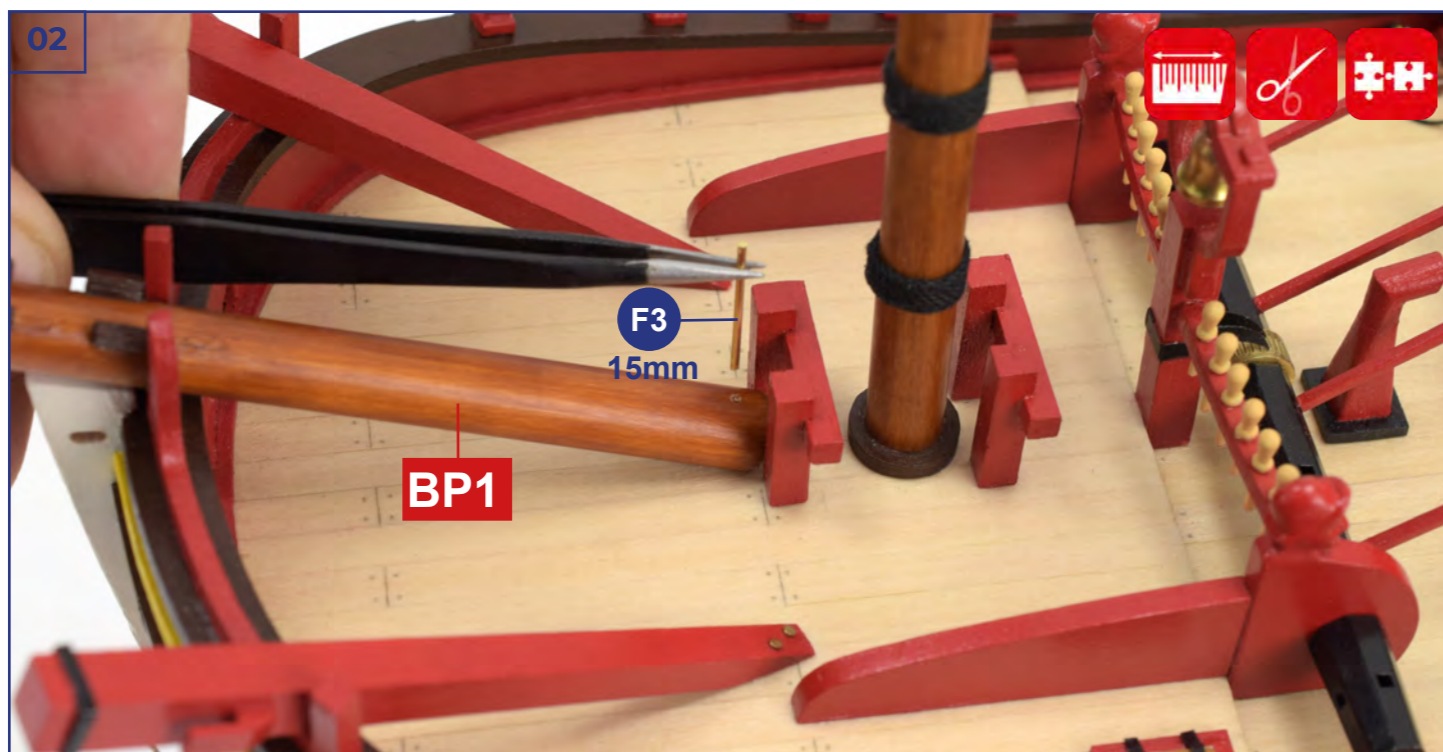
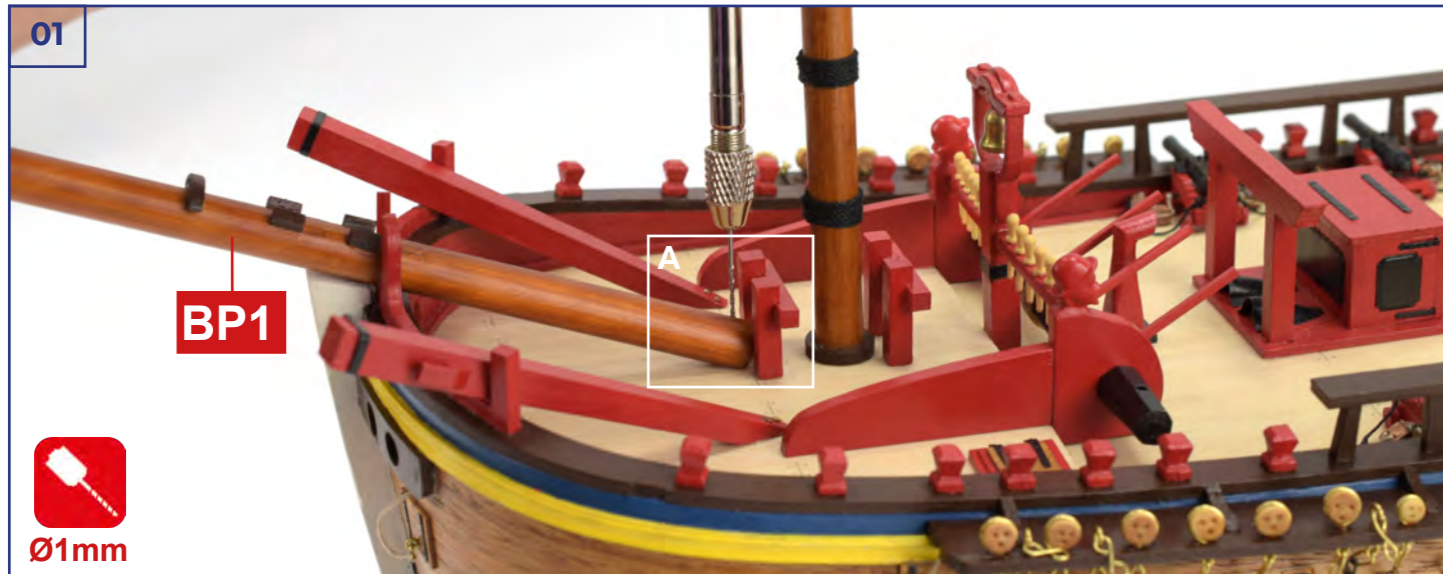

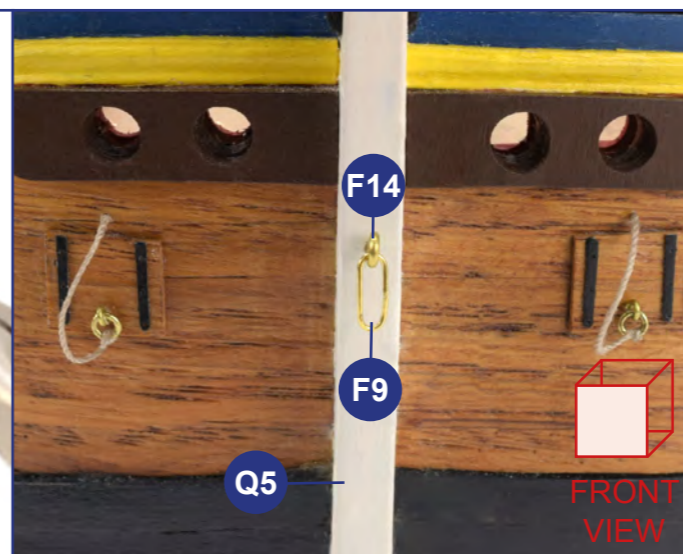
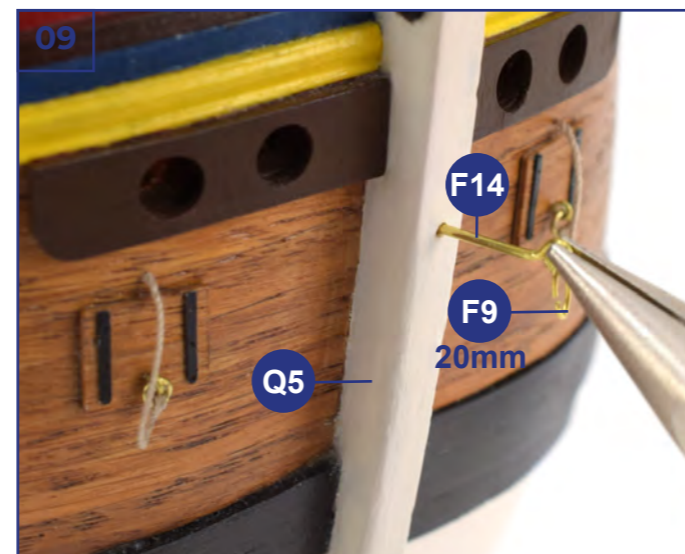
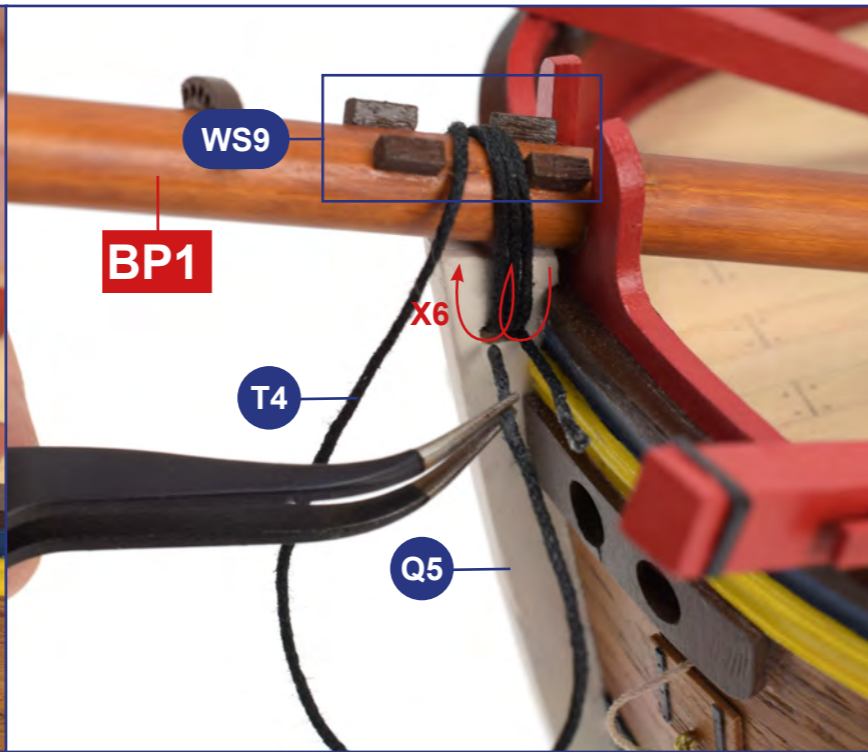
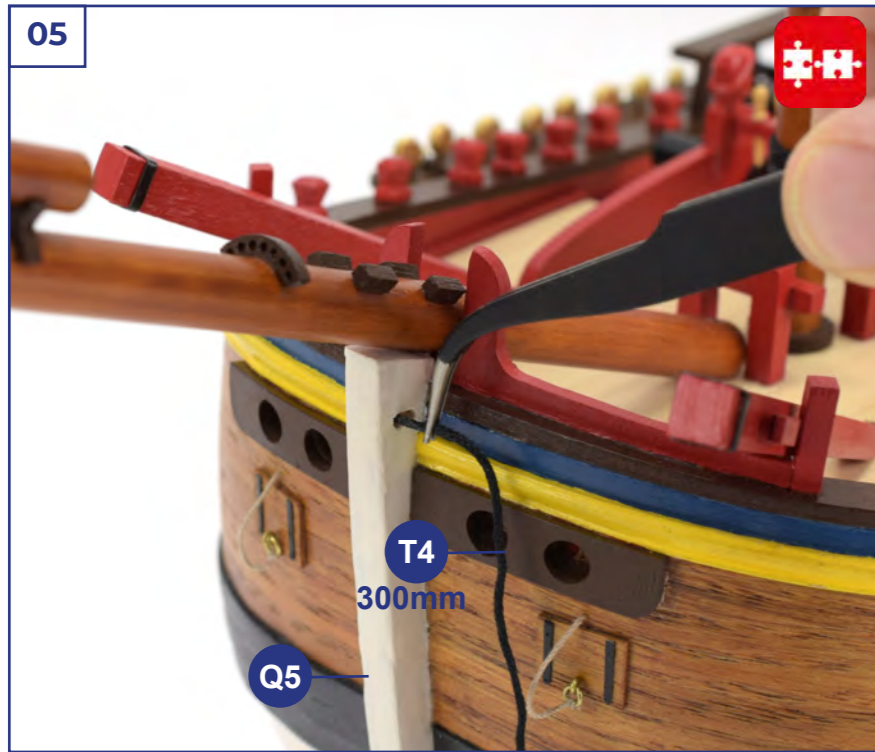

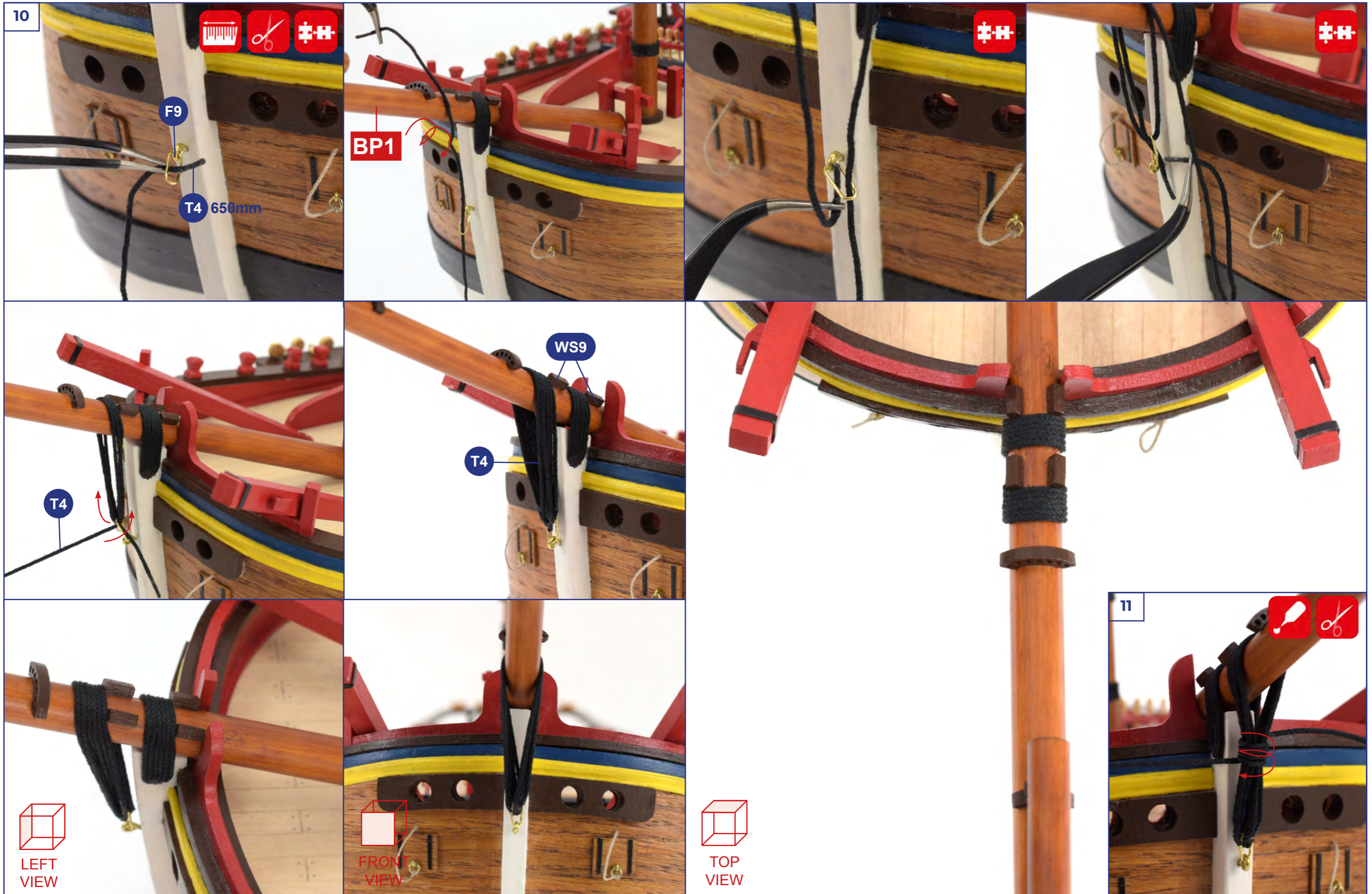

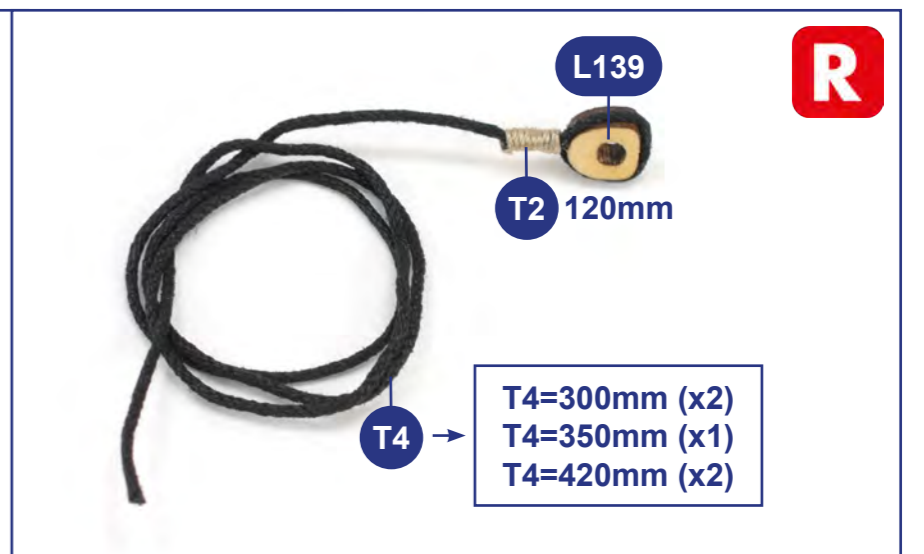
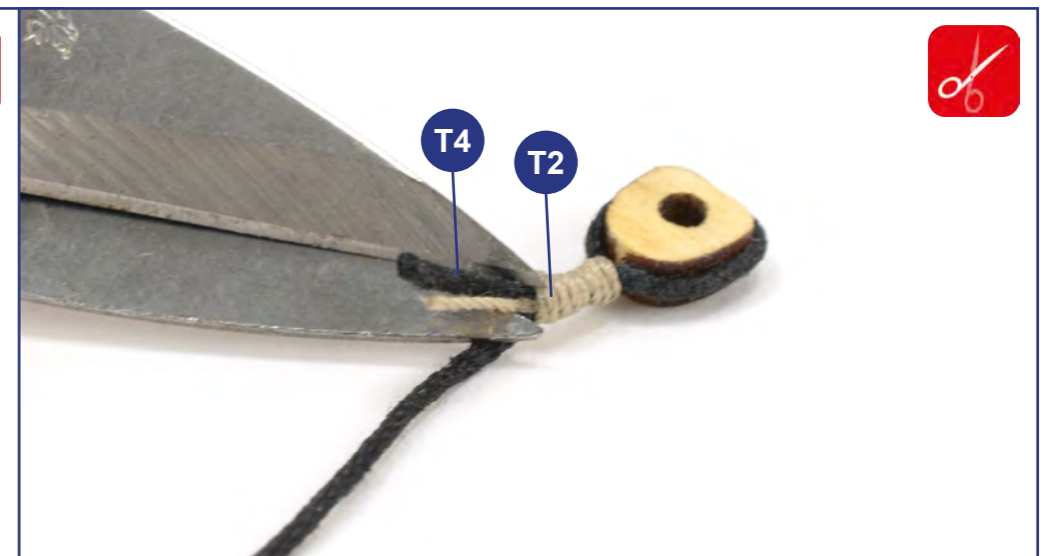
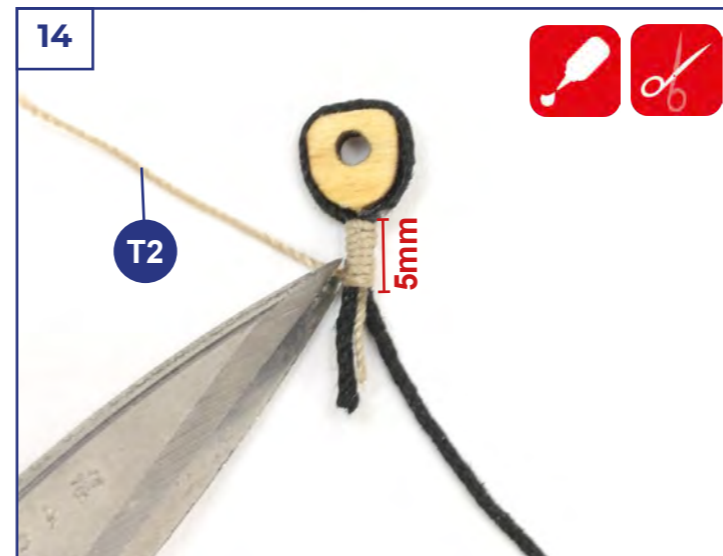
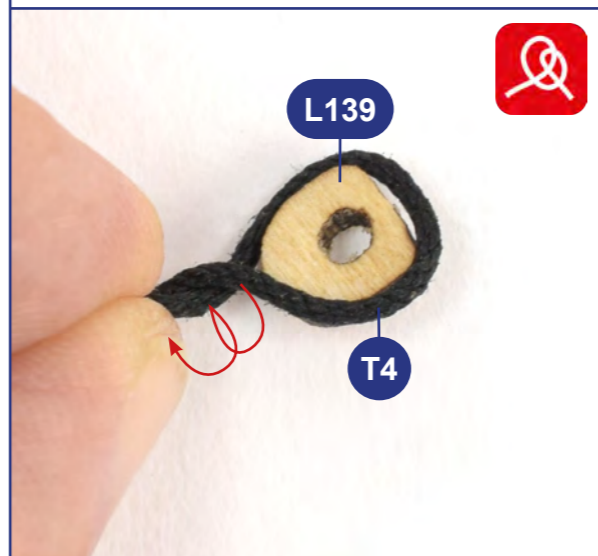
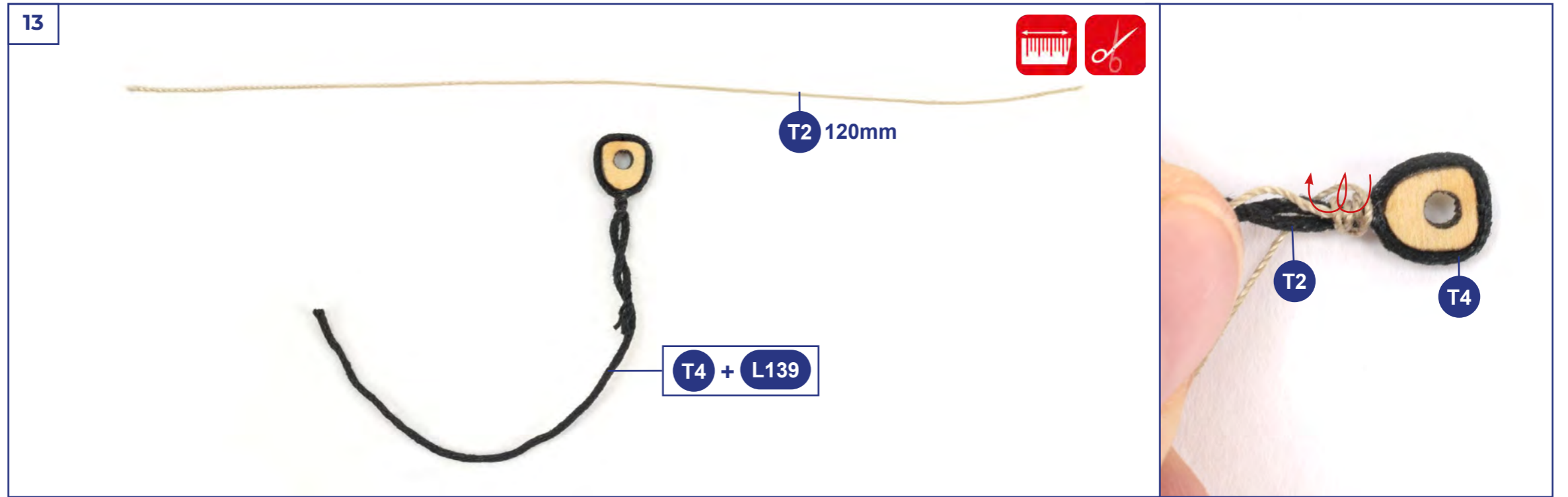
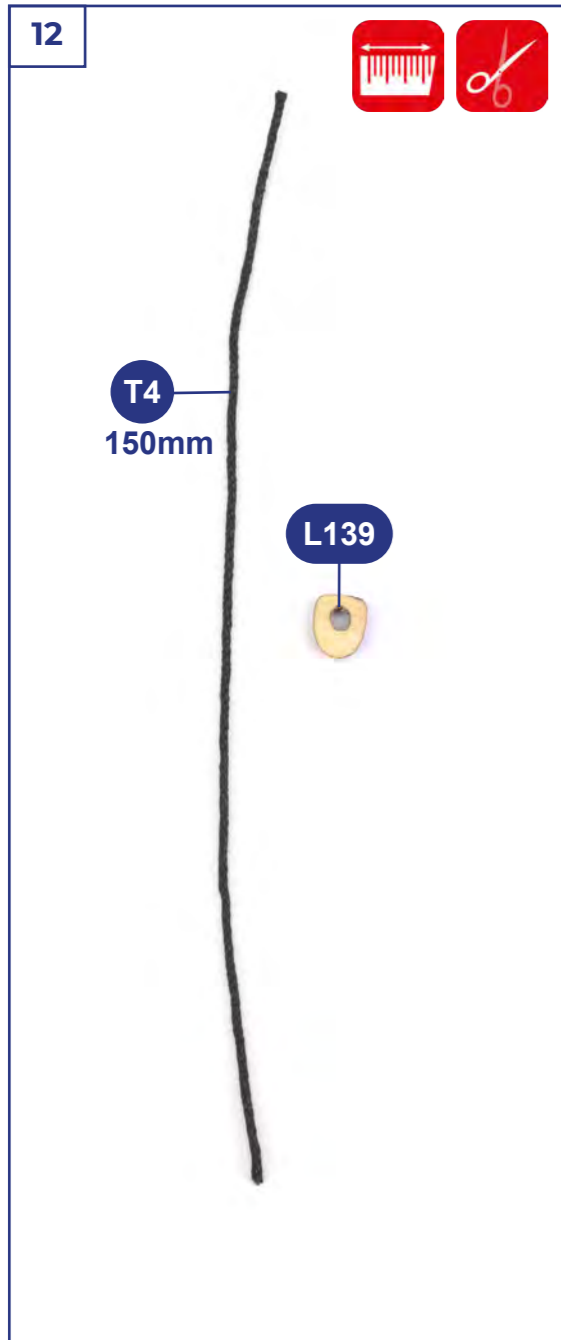

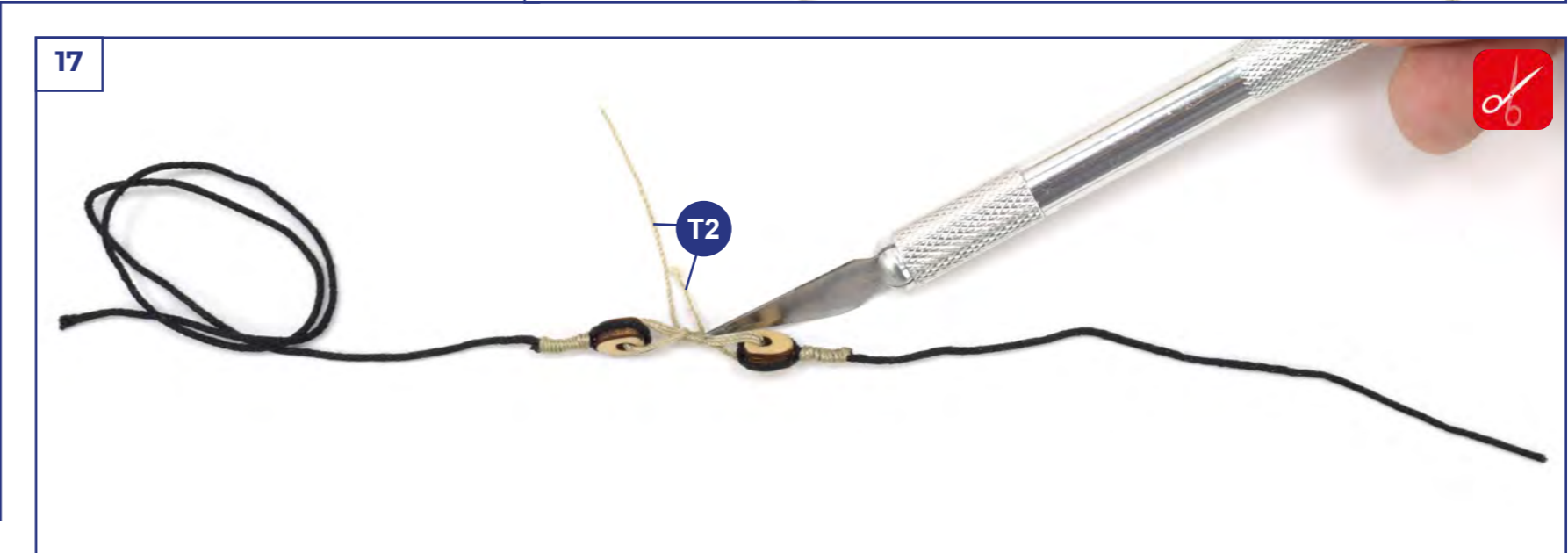
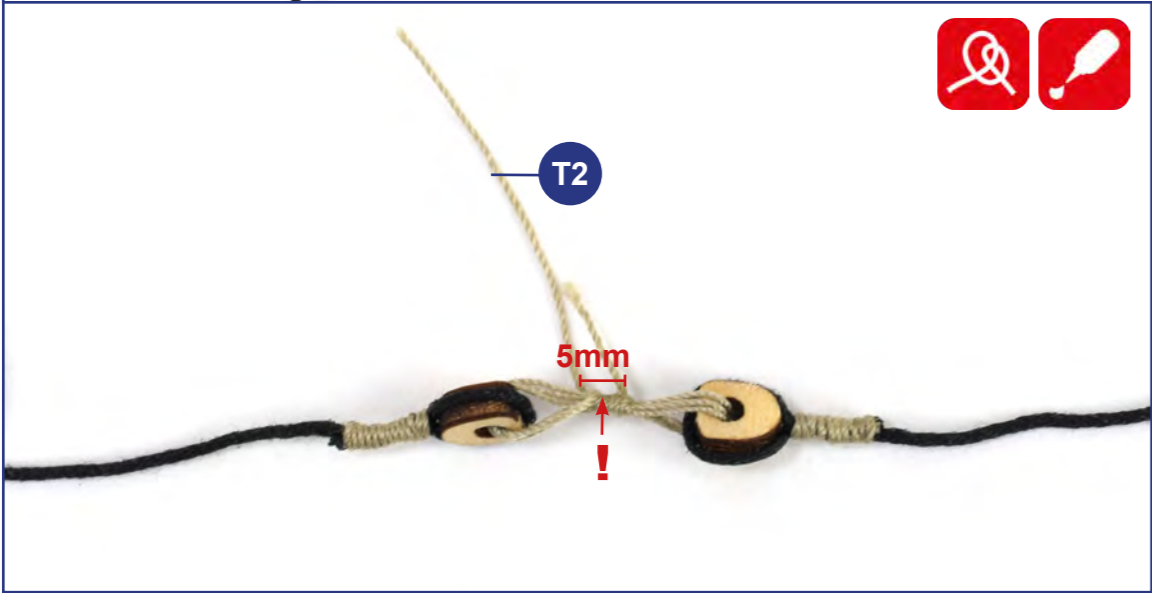
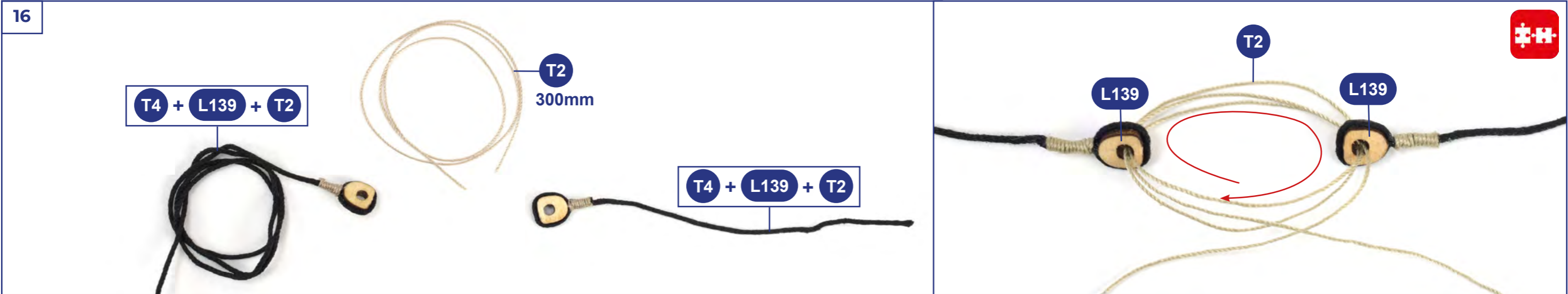

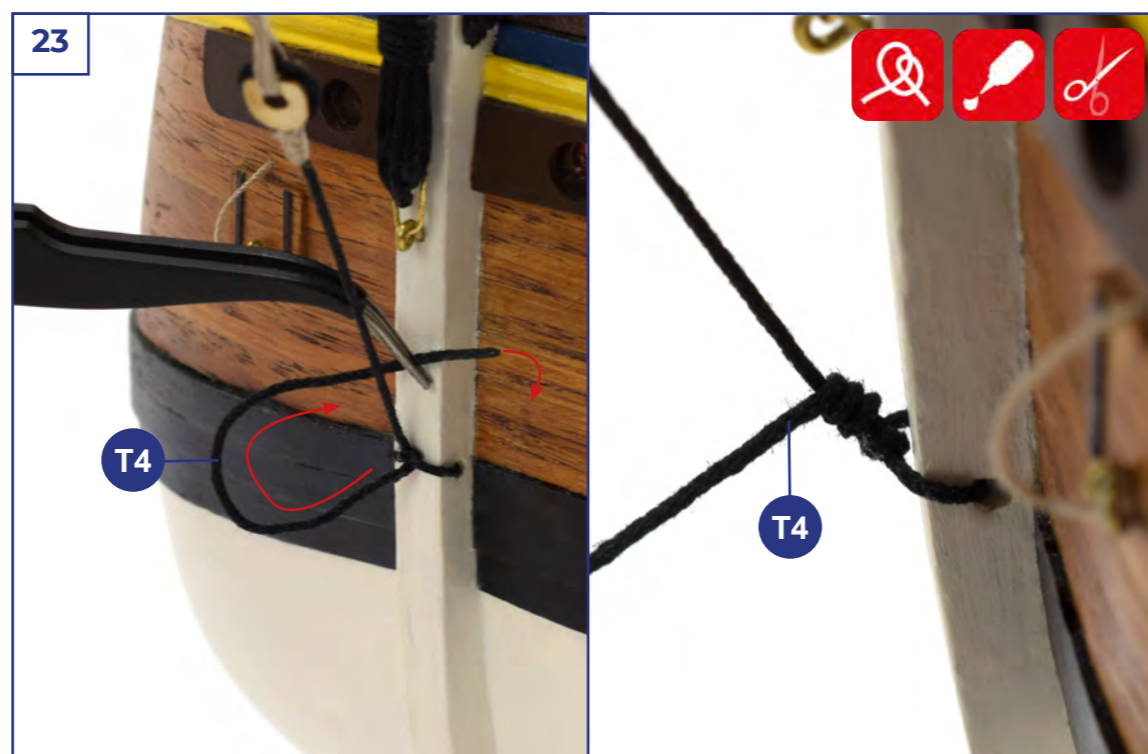
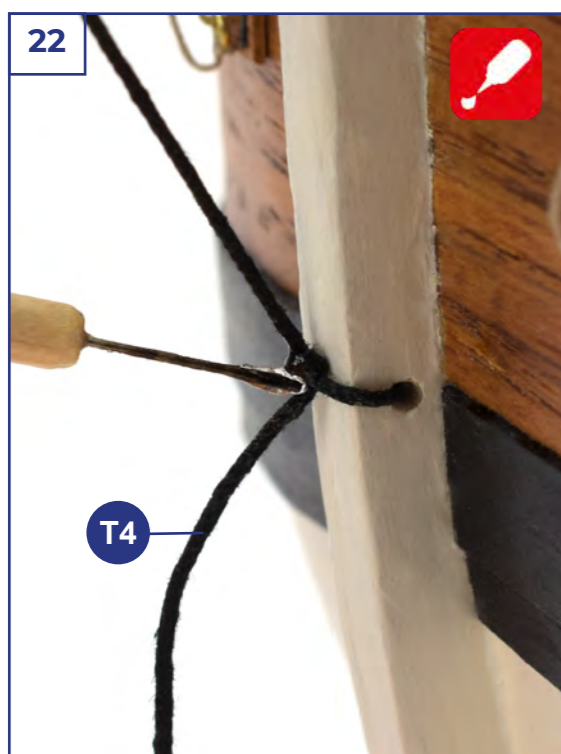
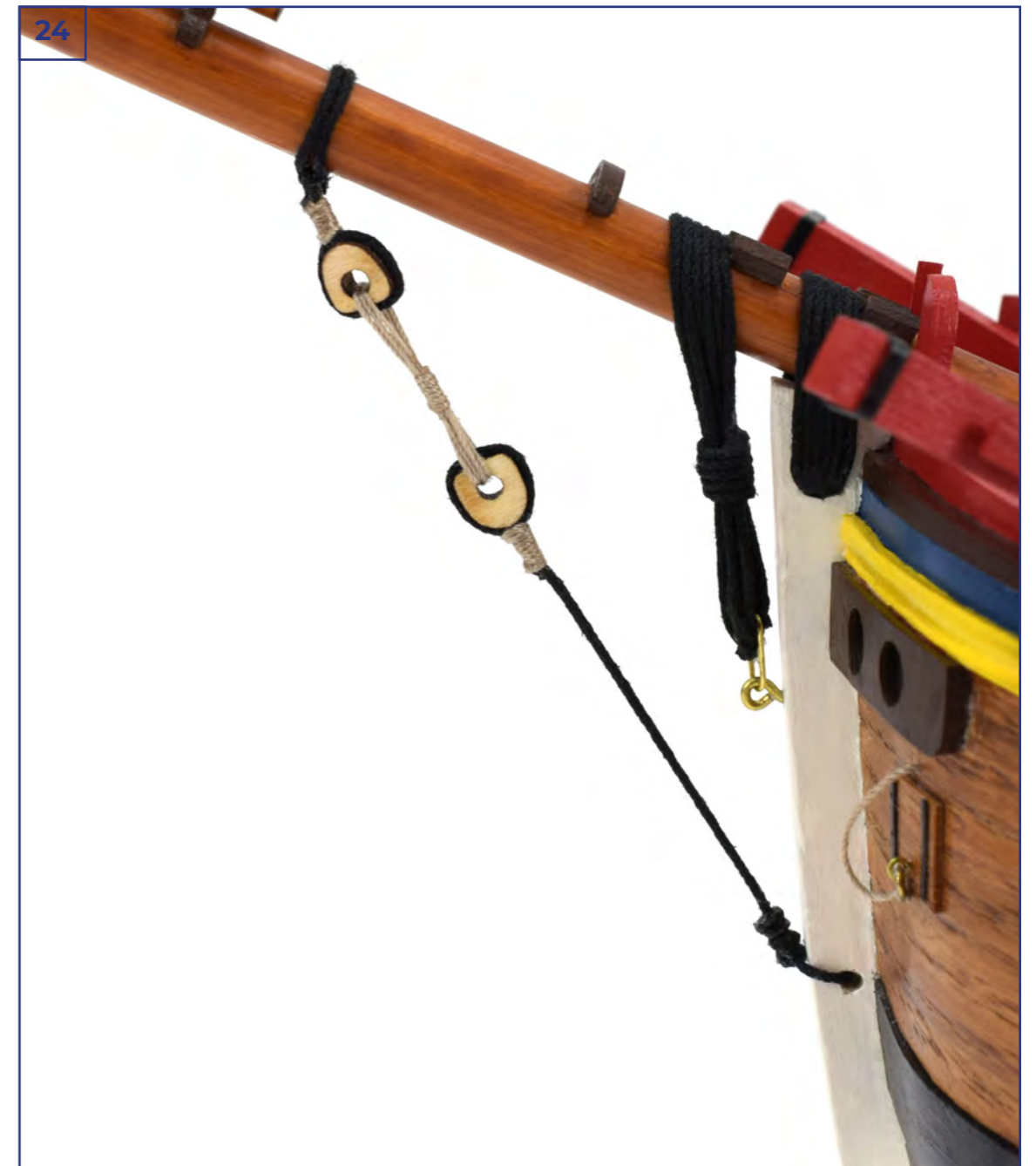
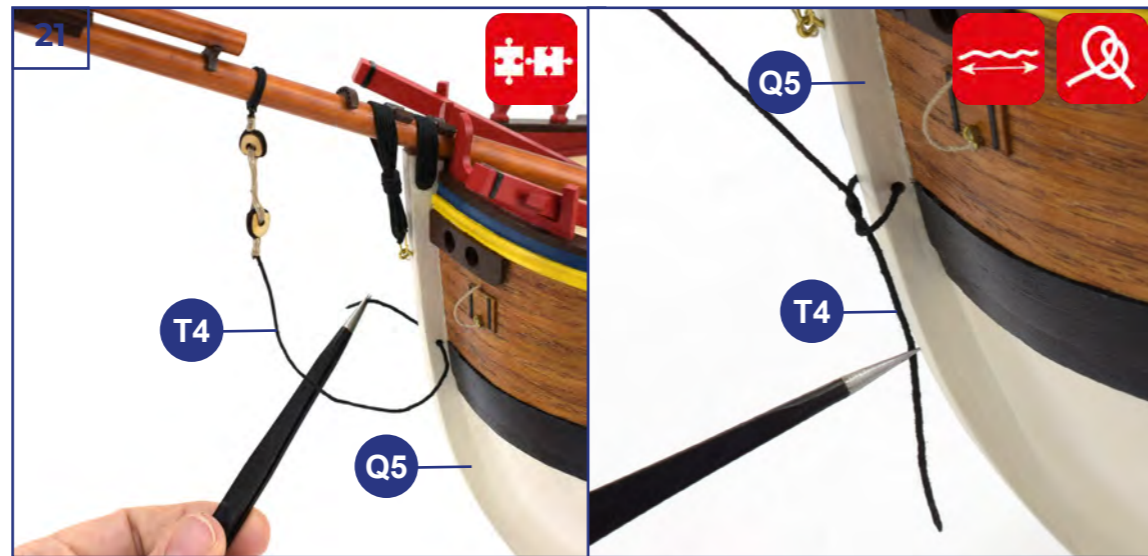

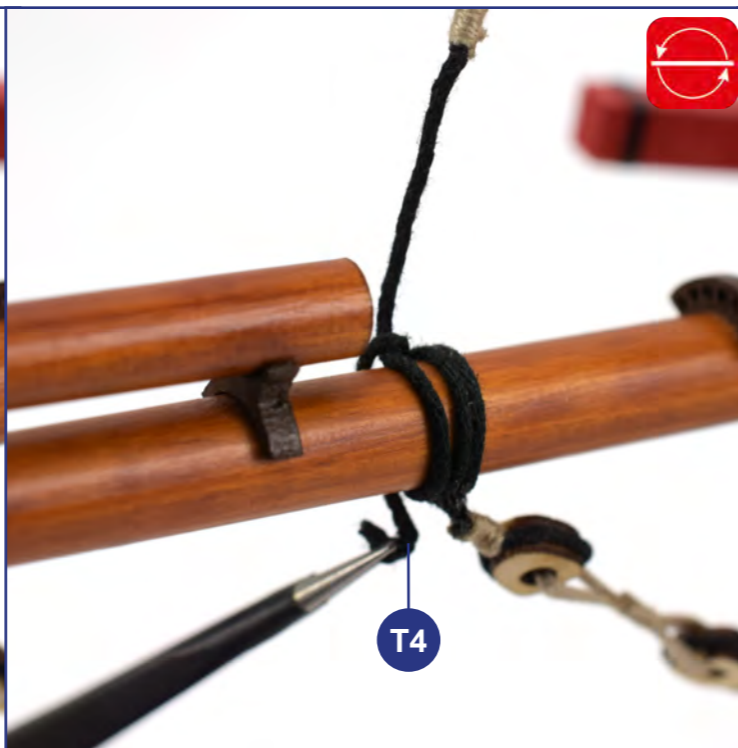
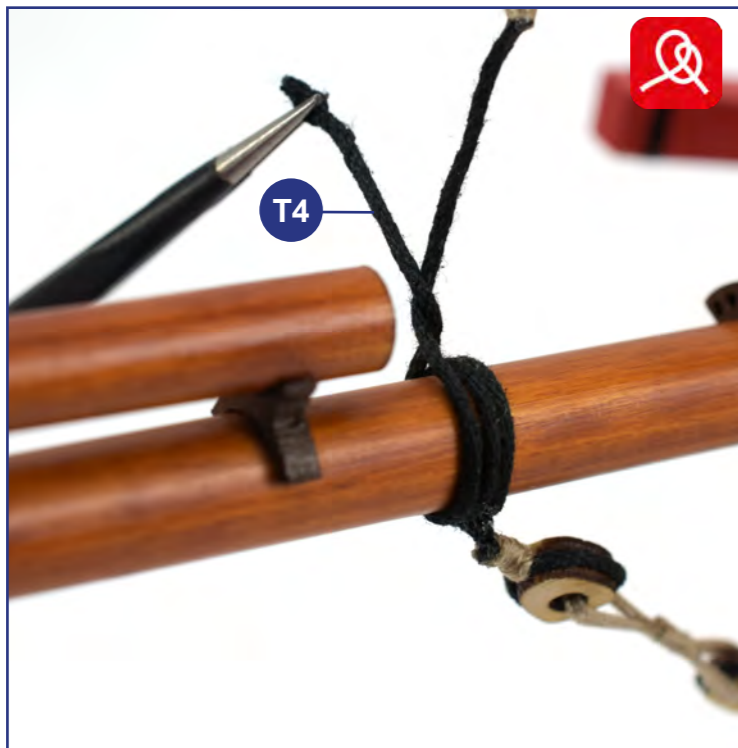
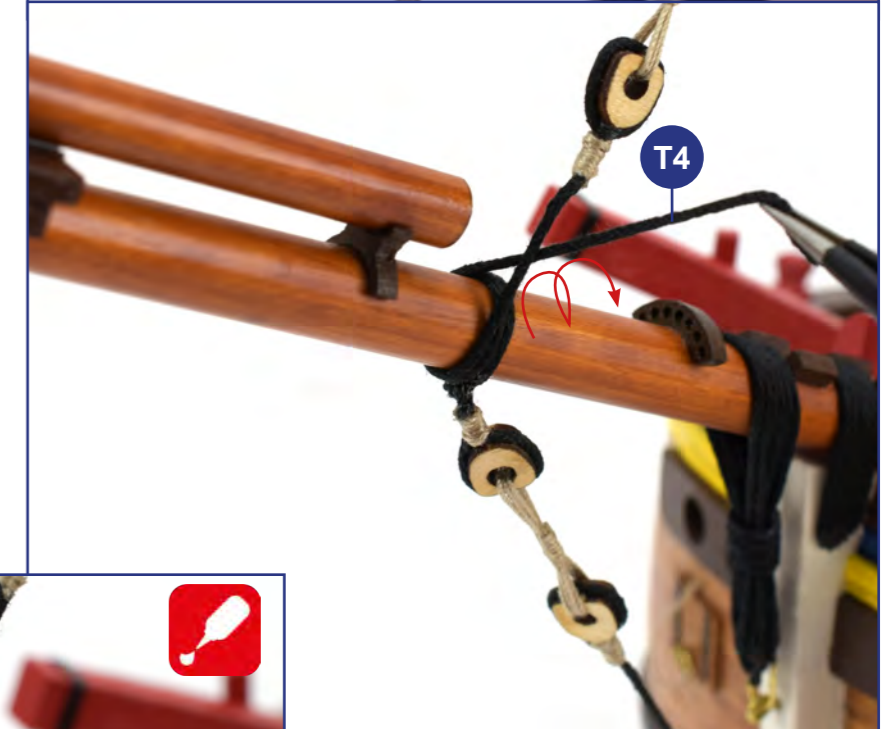
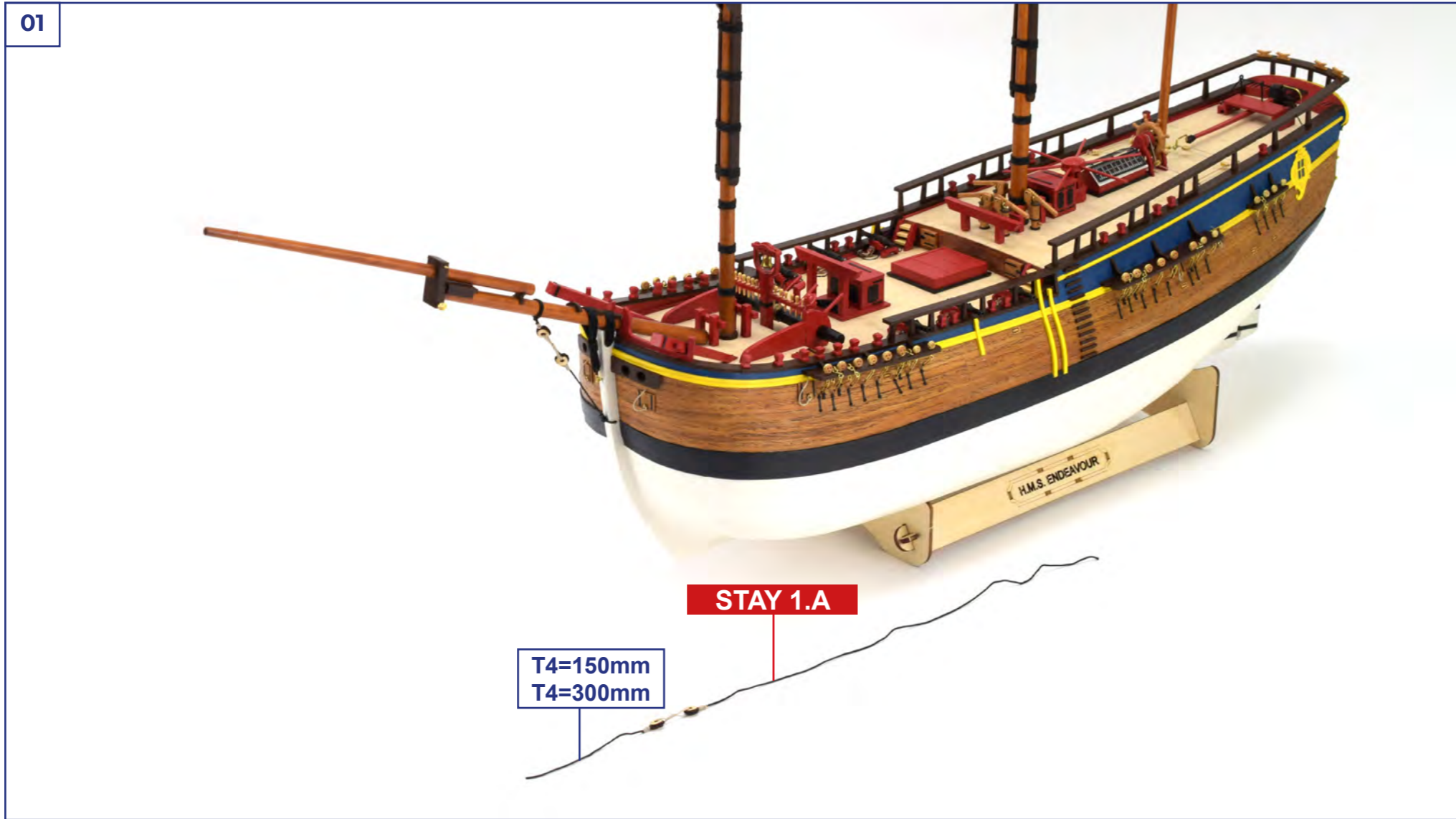

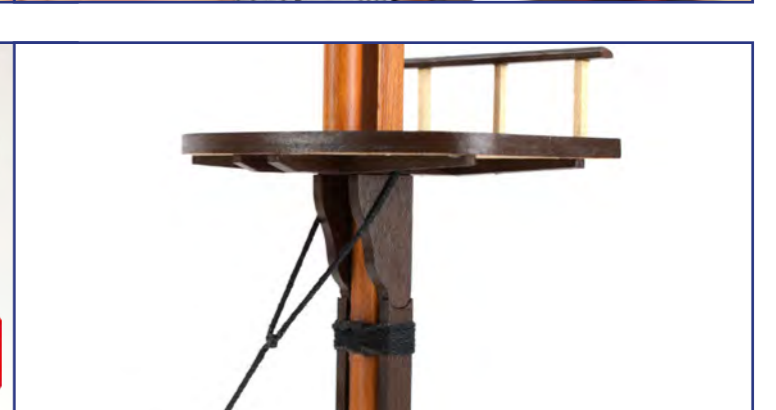
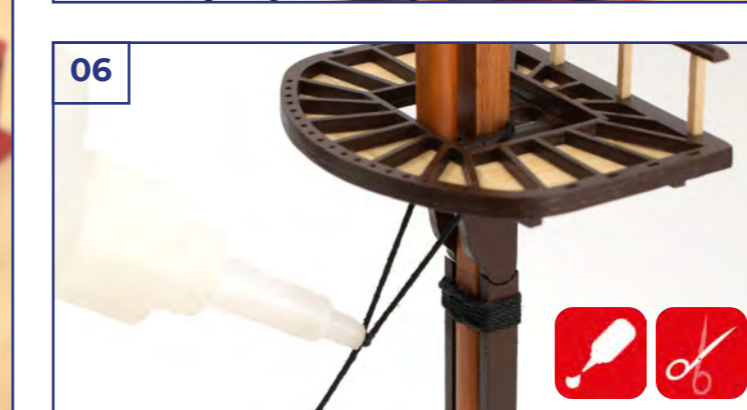
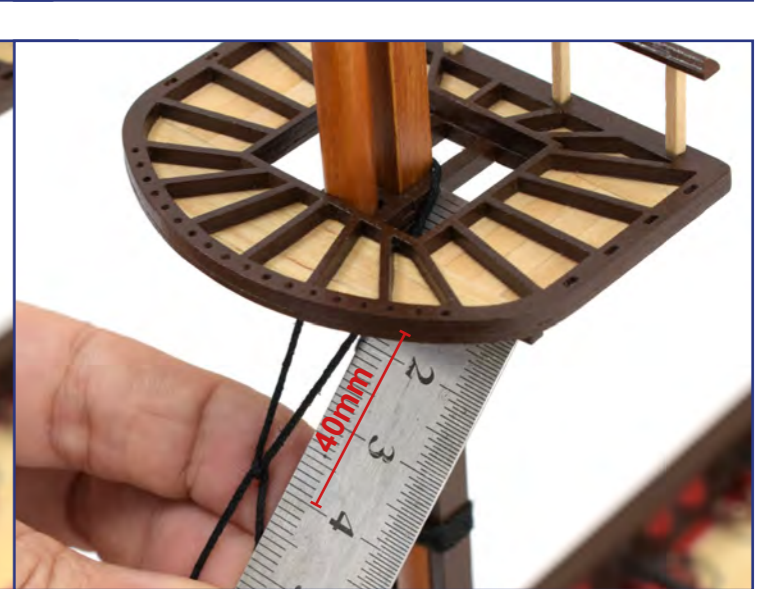
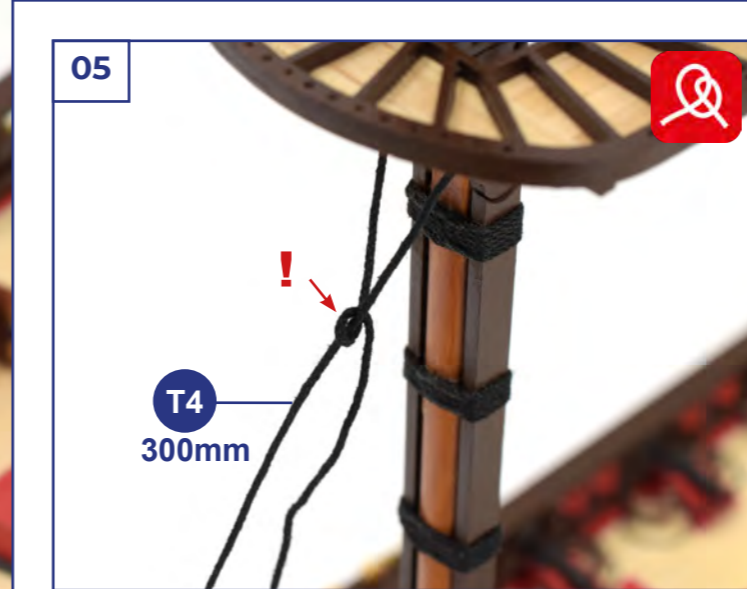
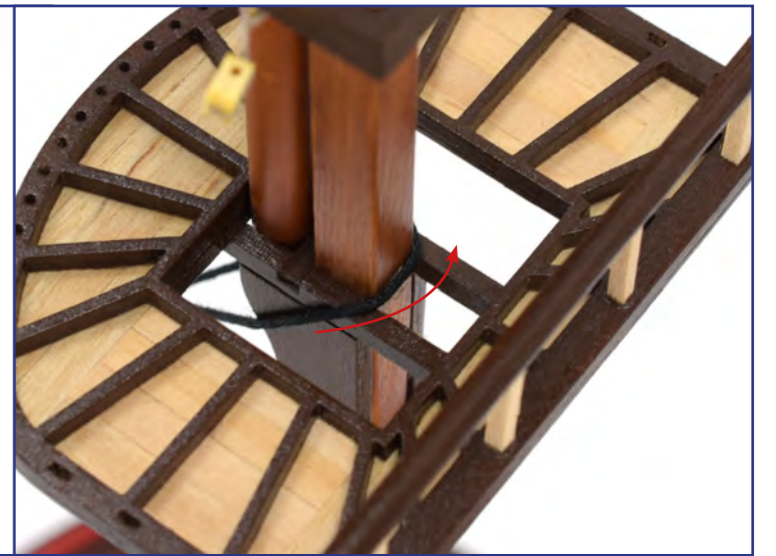
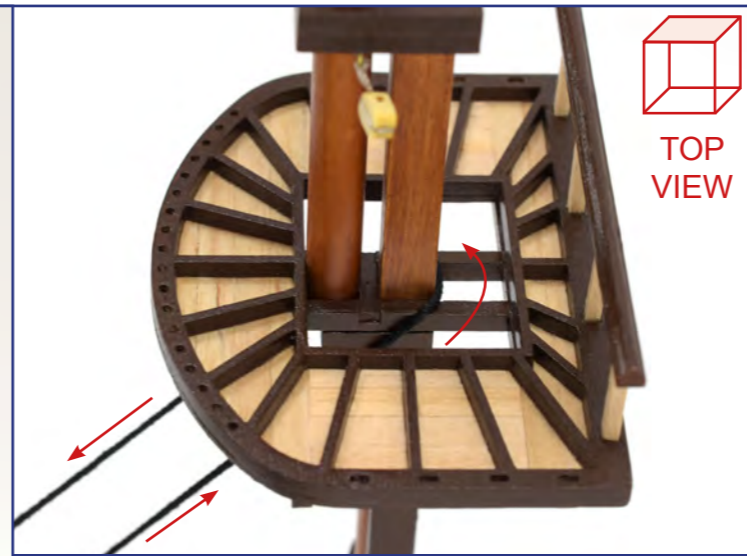
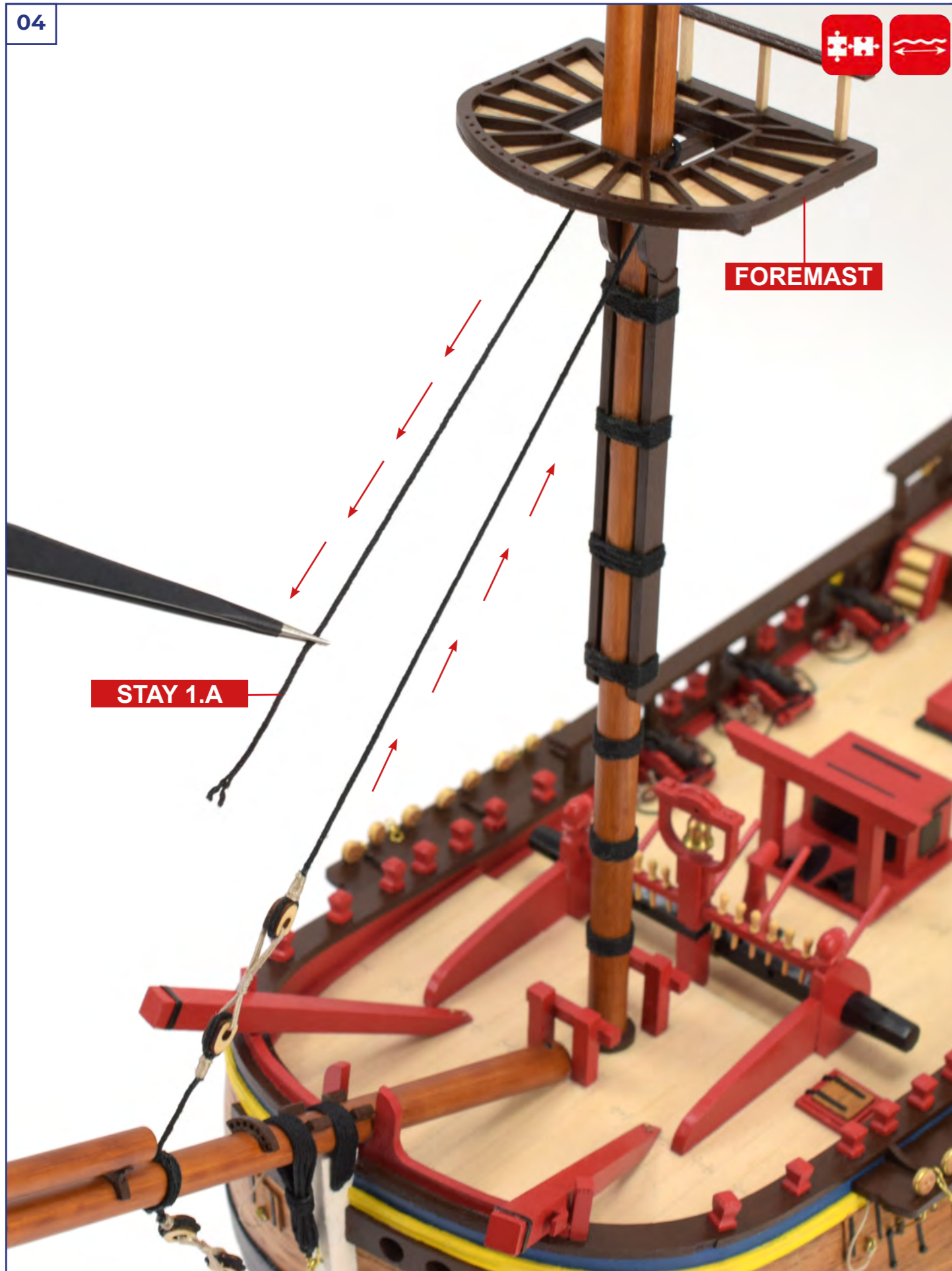

07

A

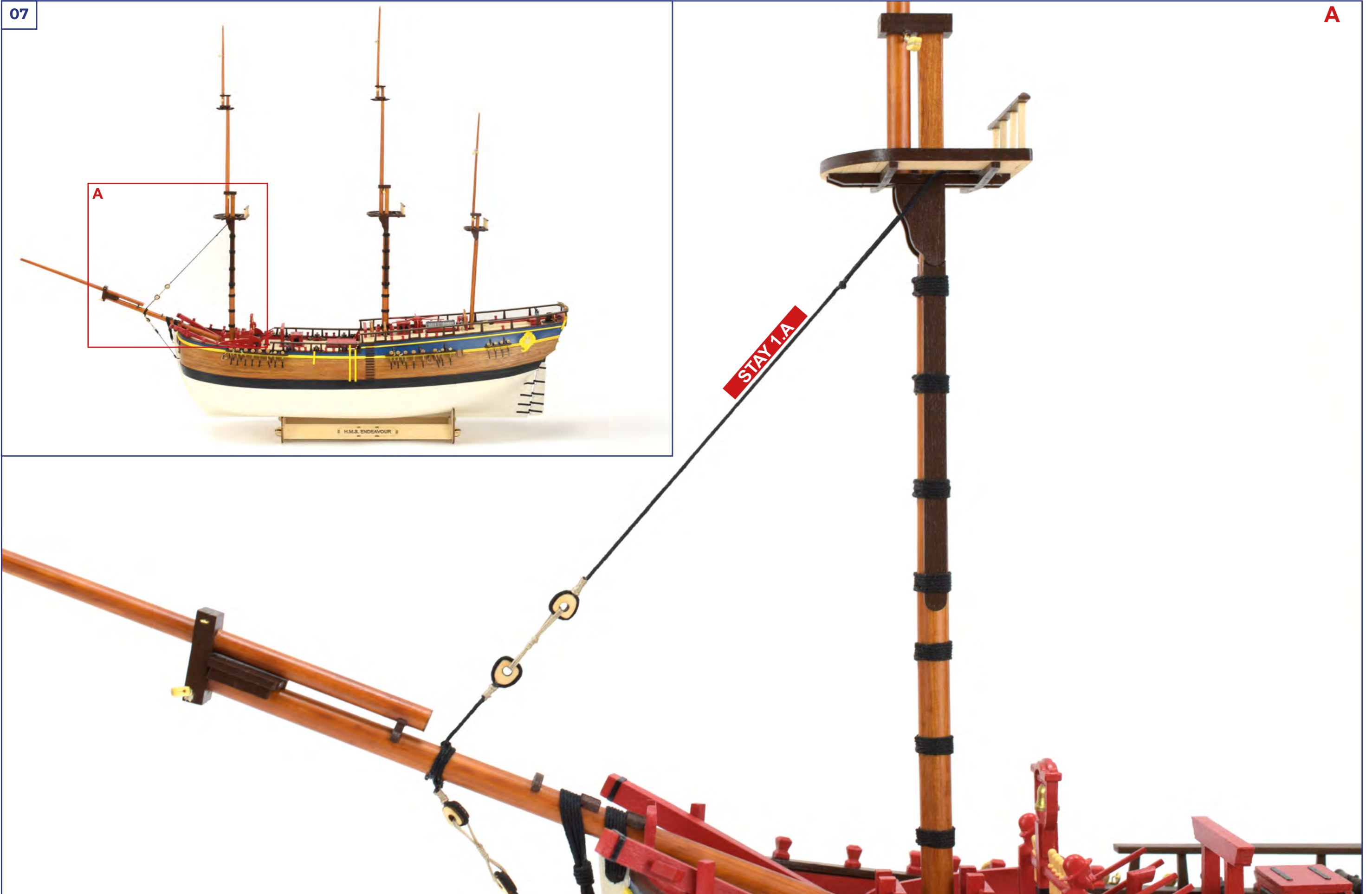

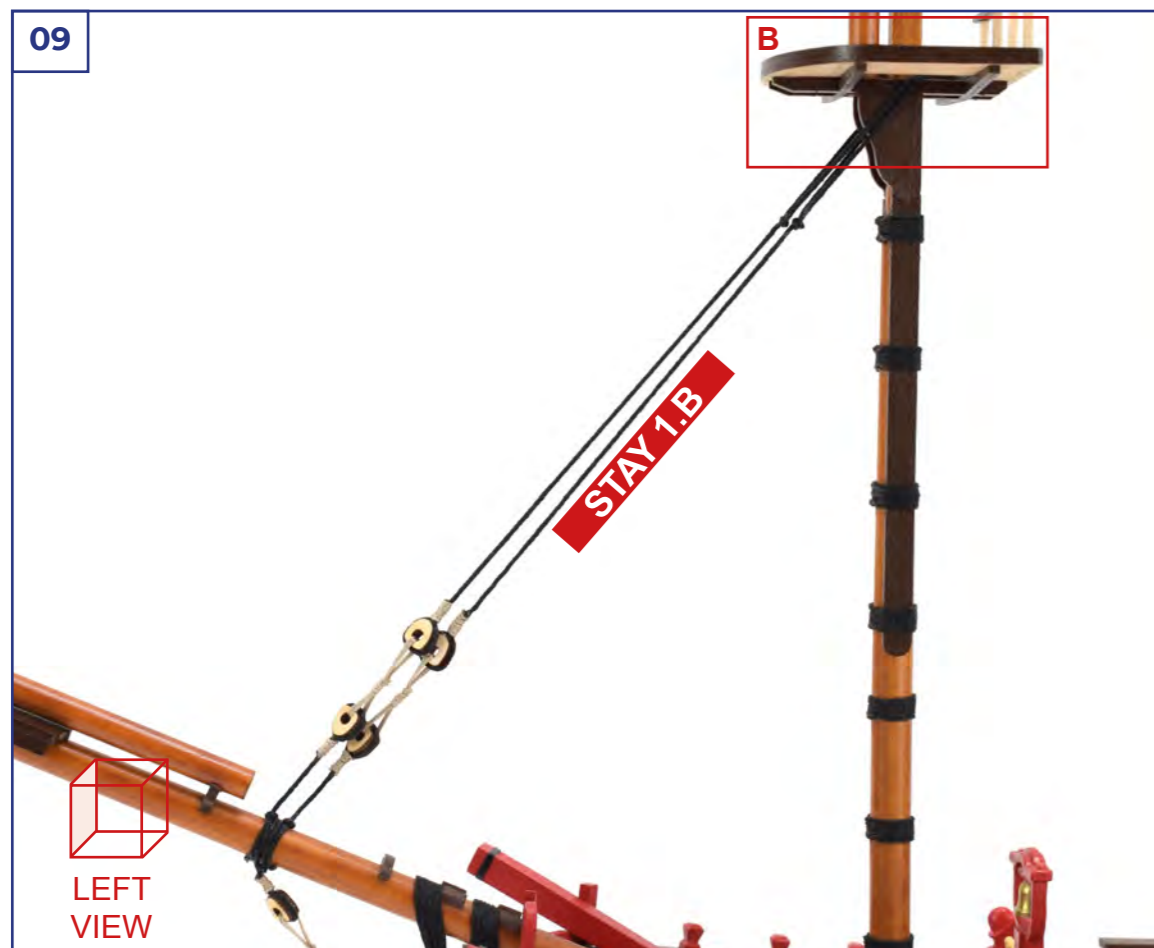
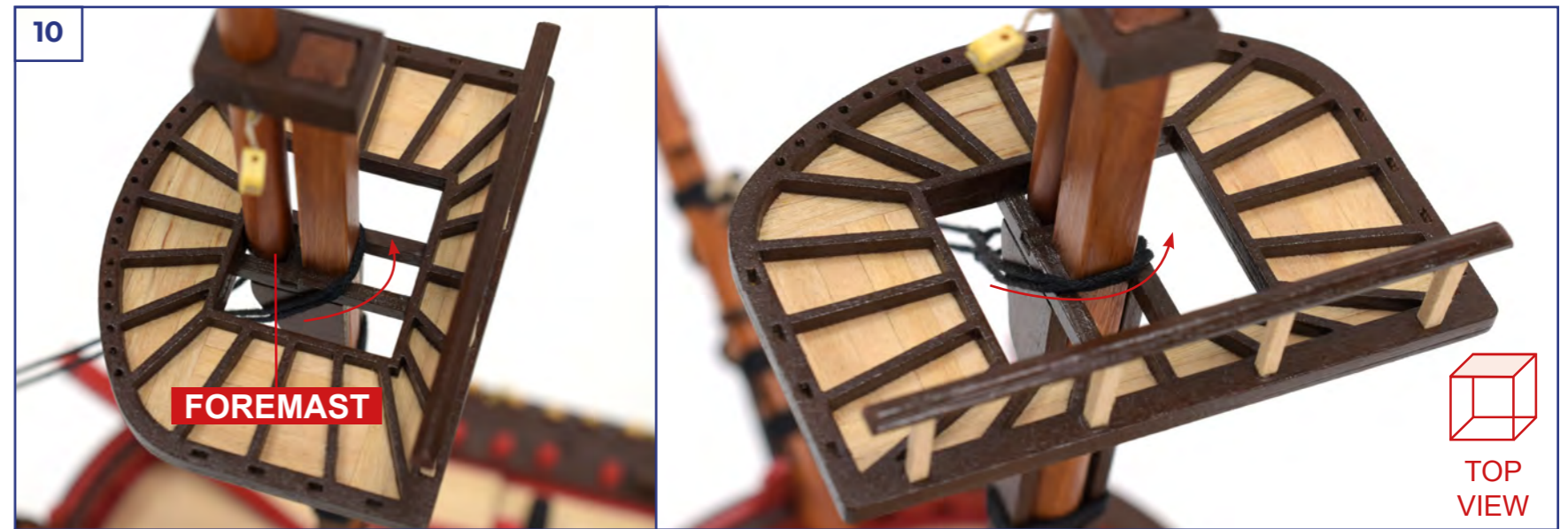
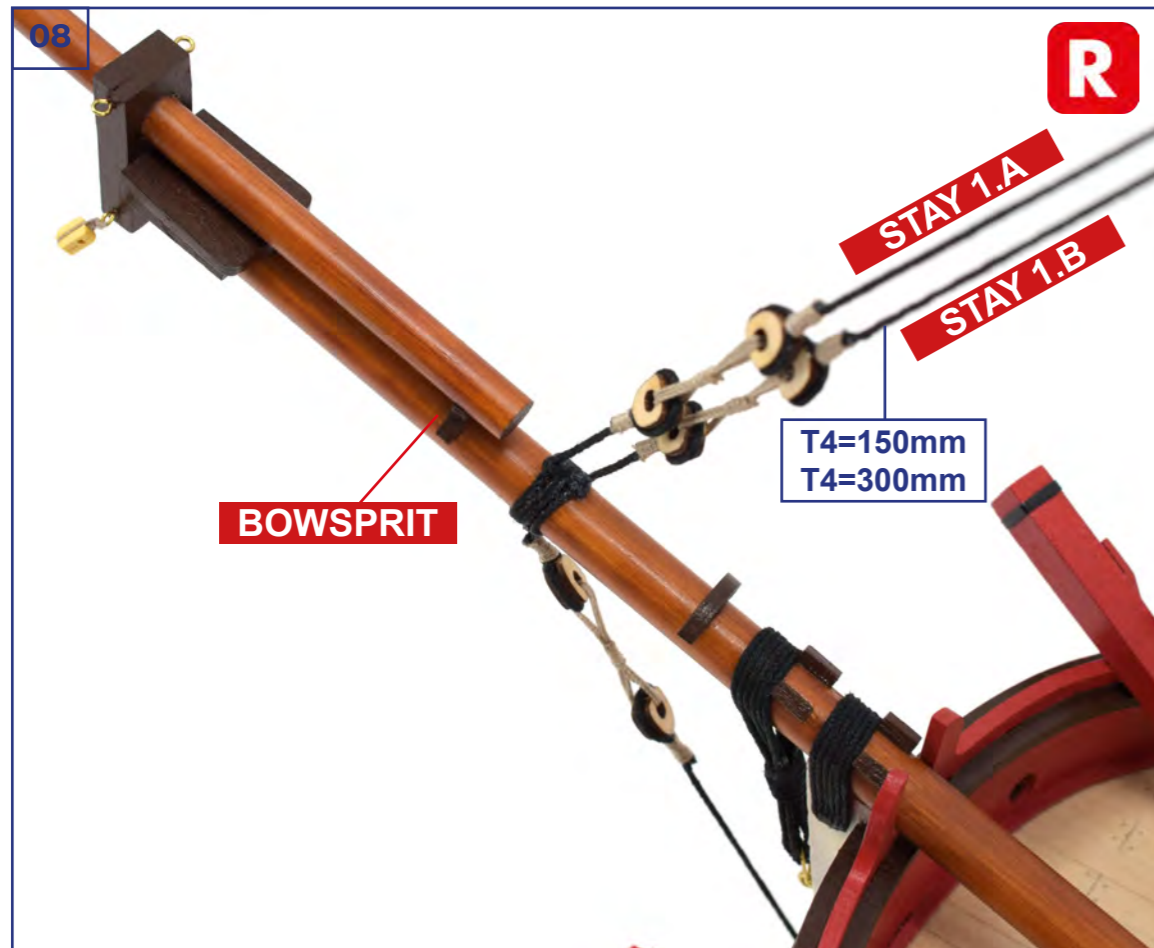

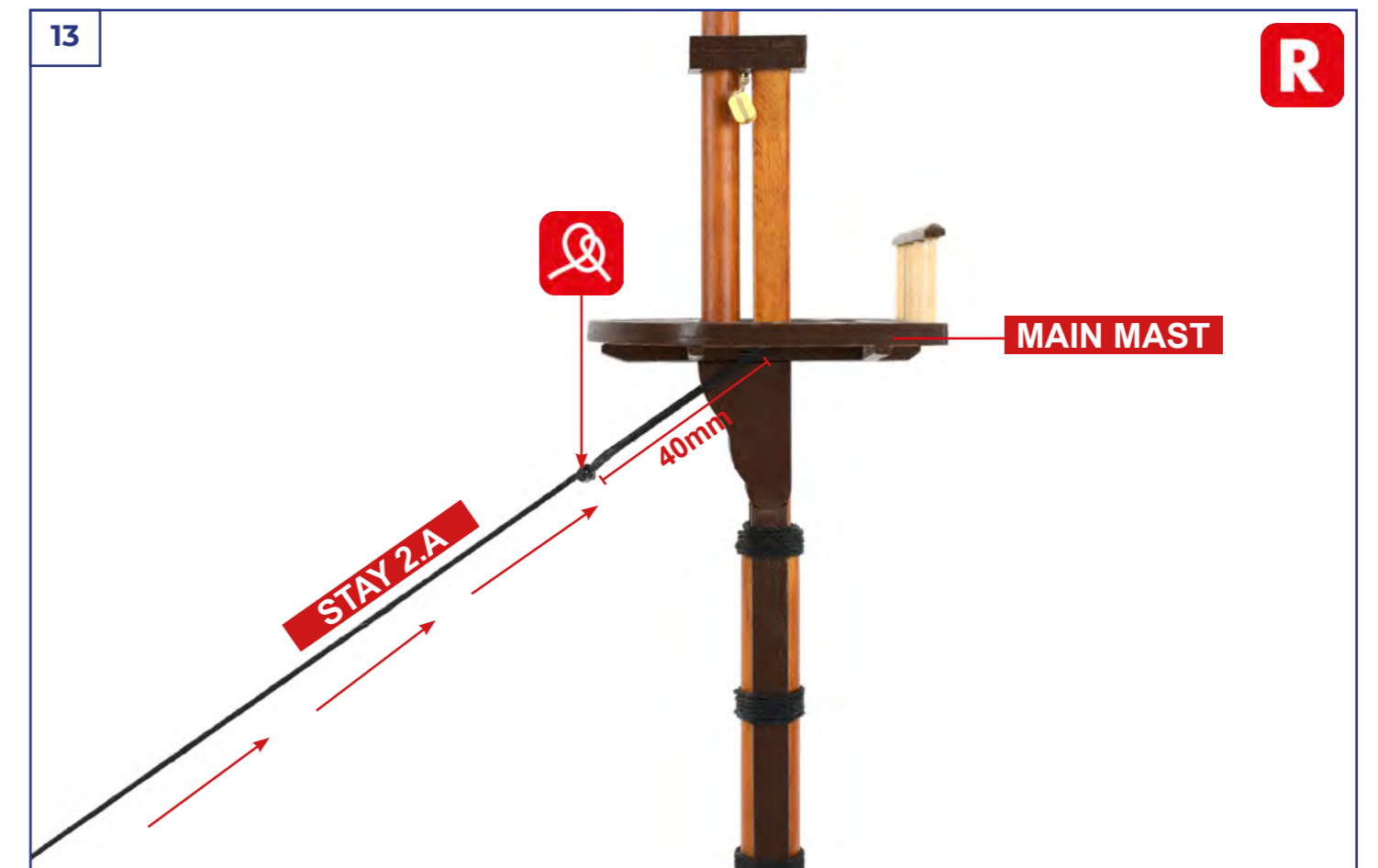
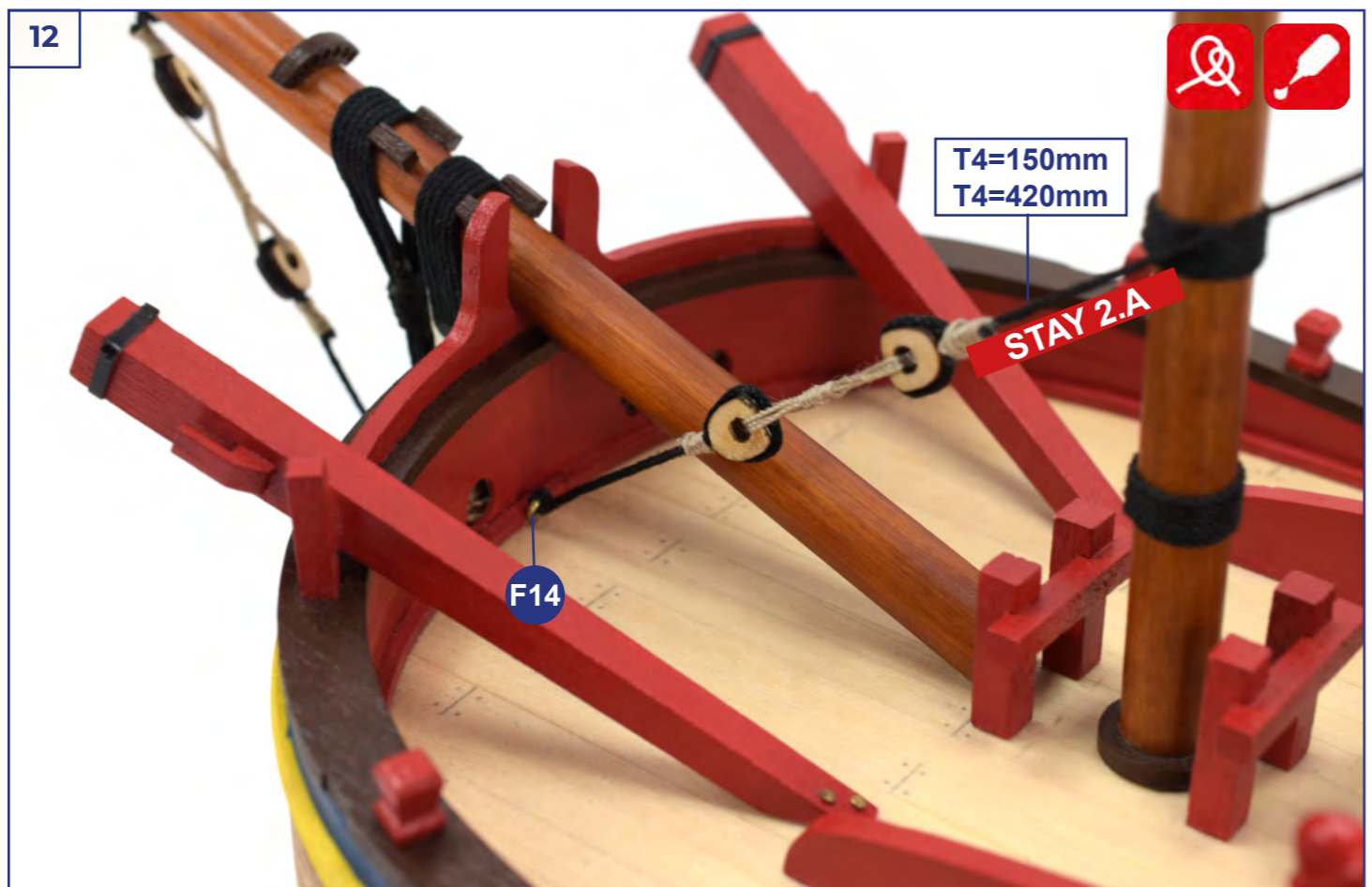
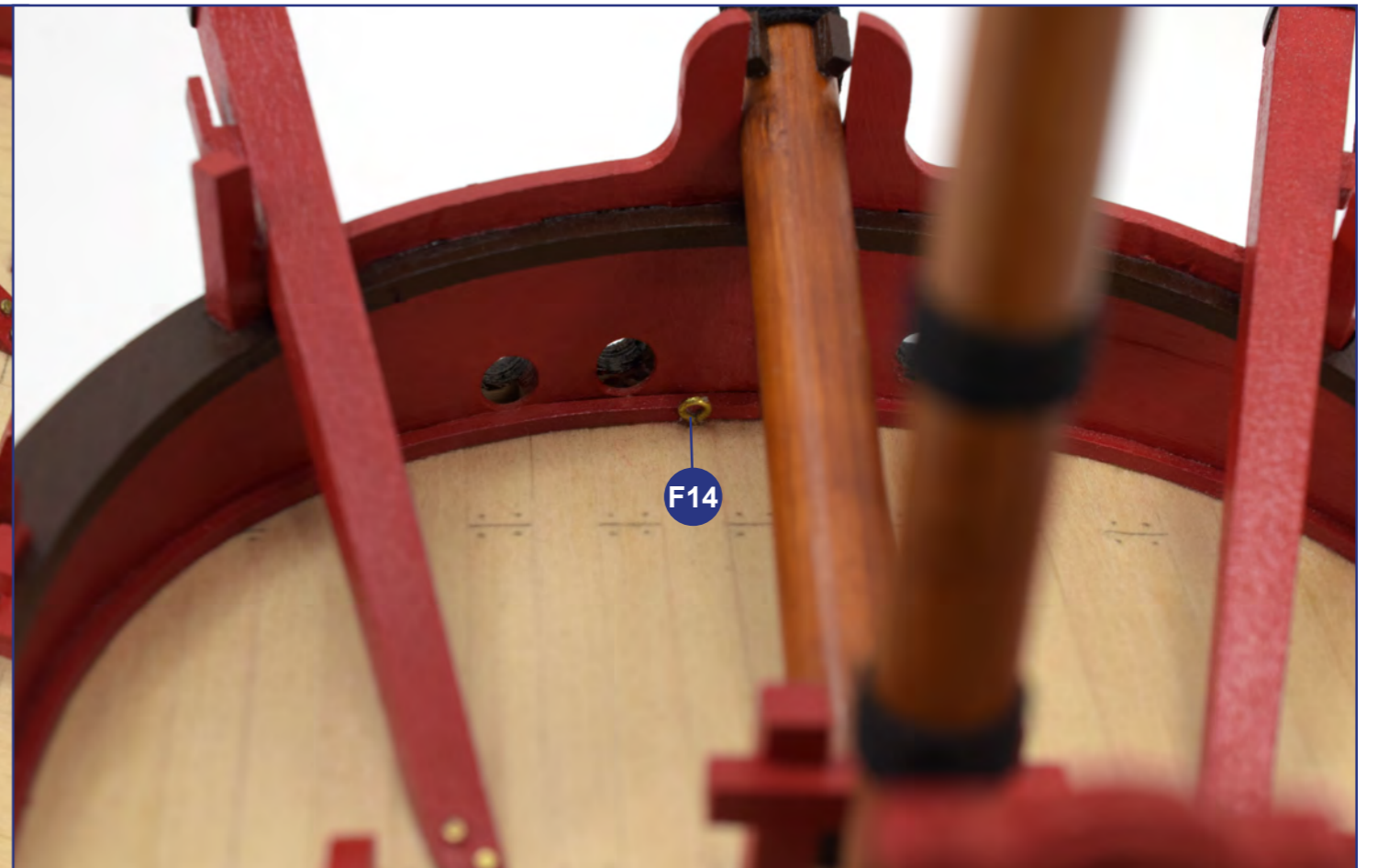

14



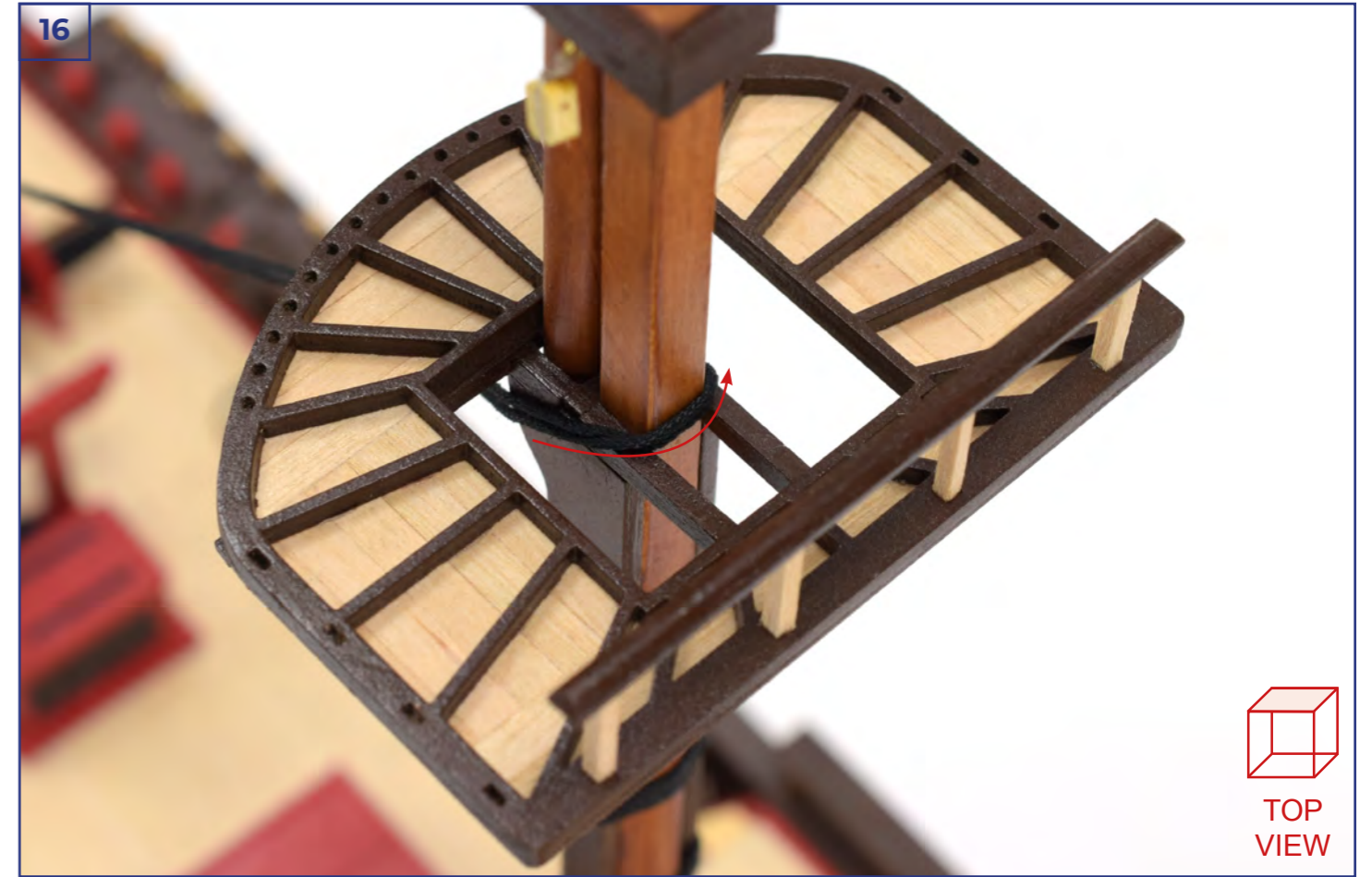
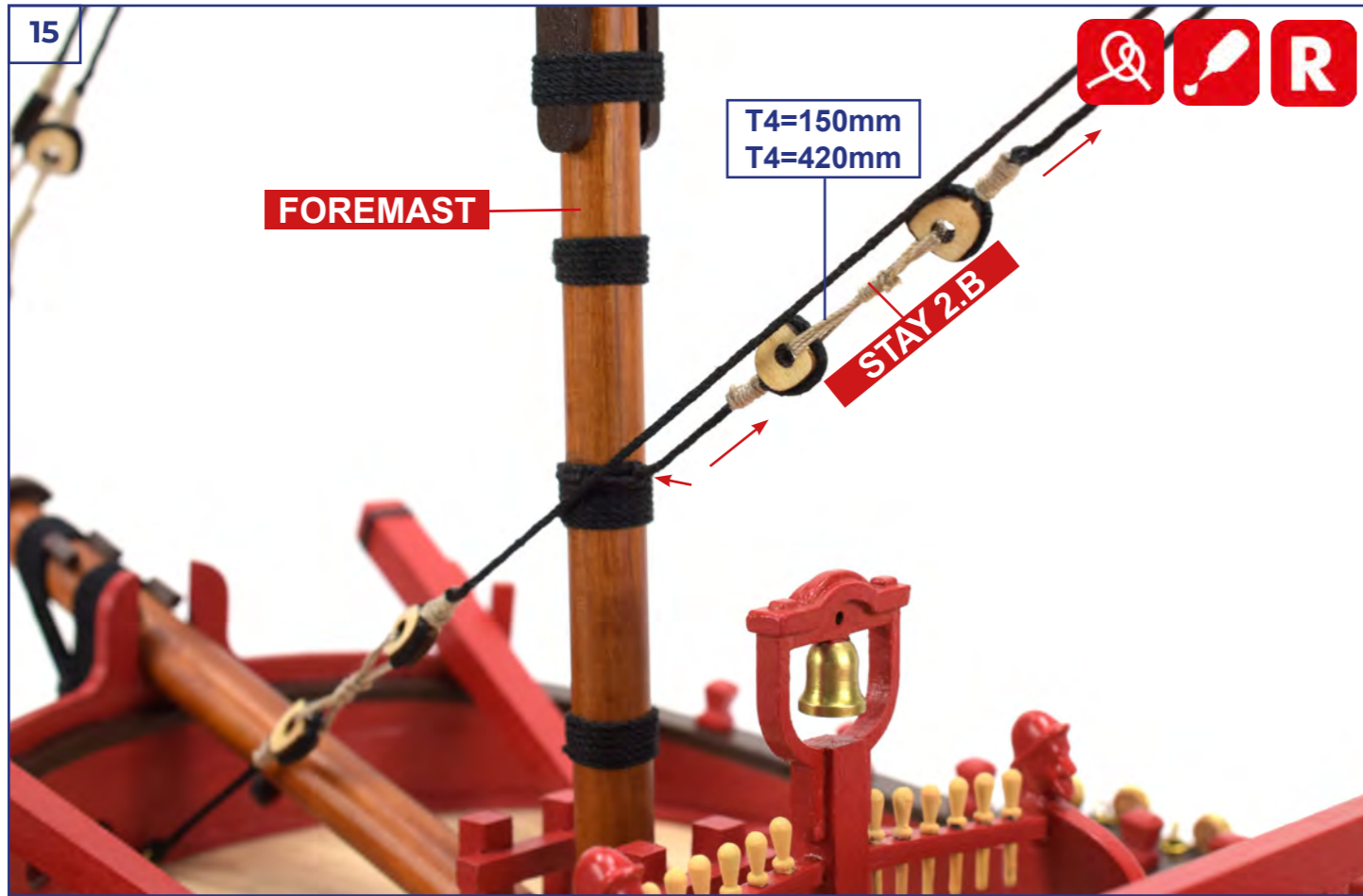

18



19

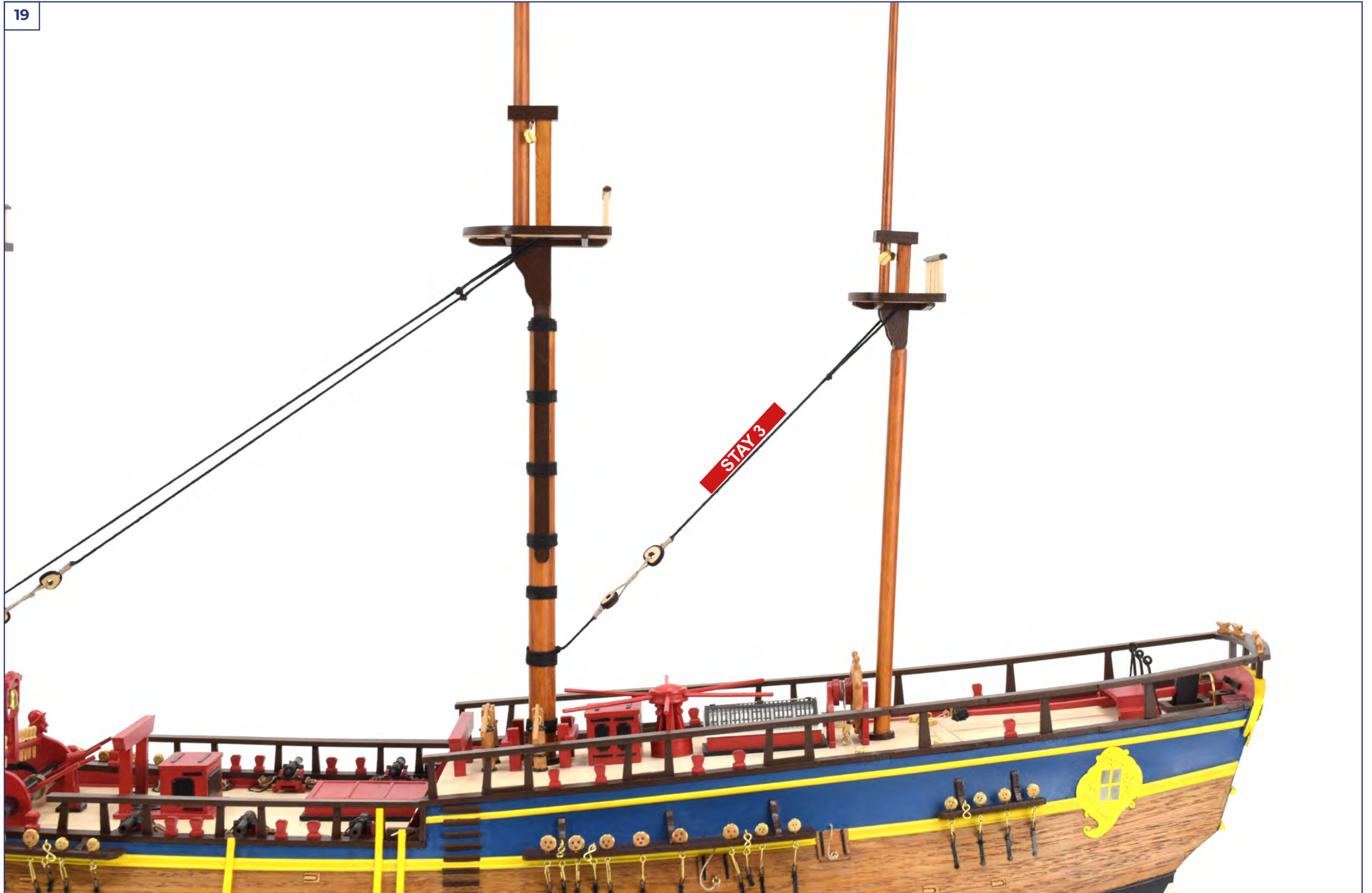

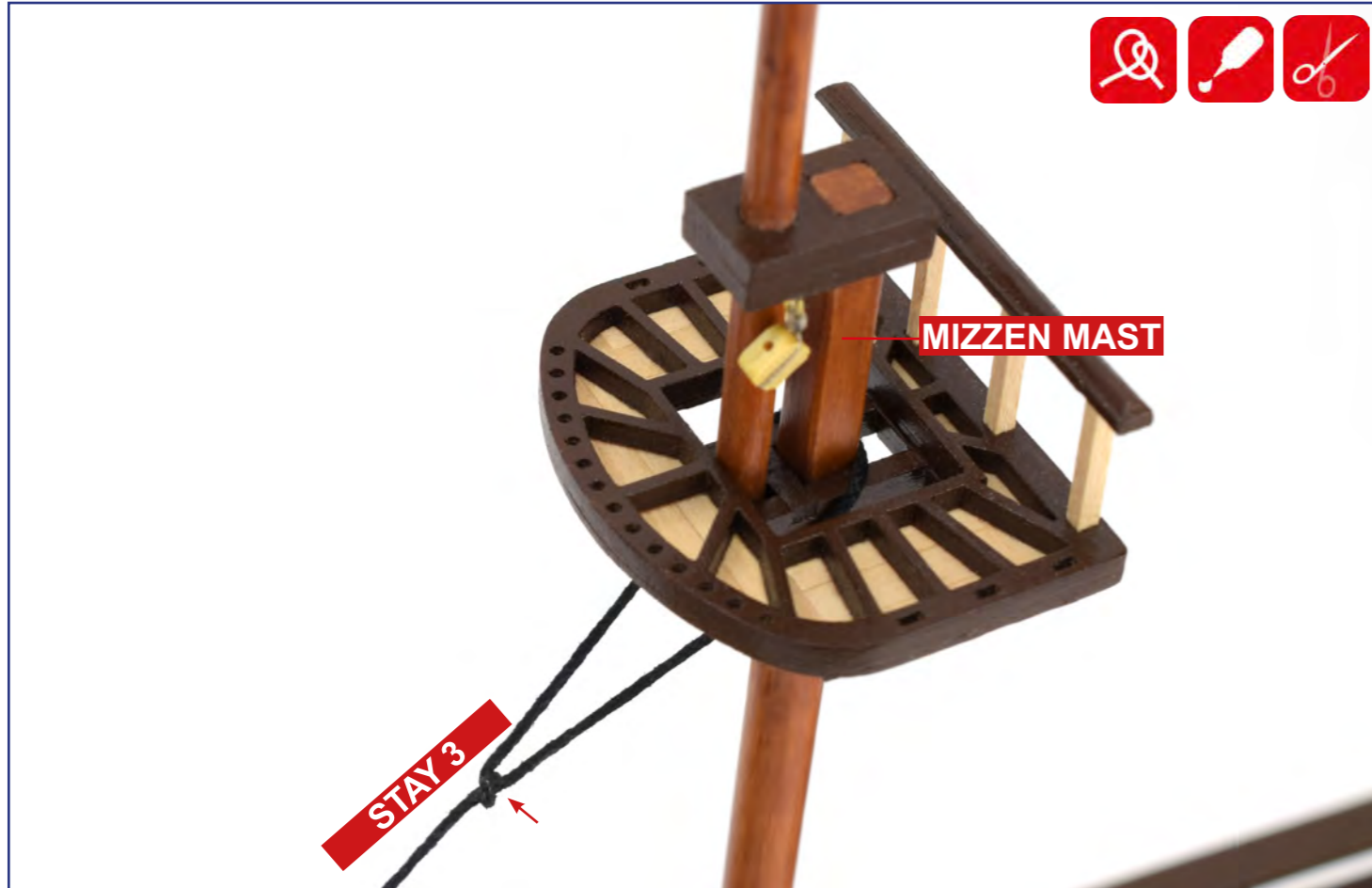
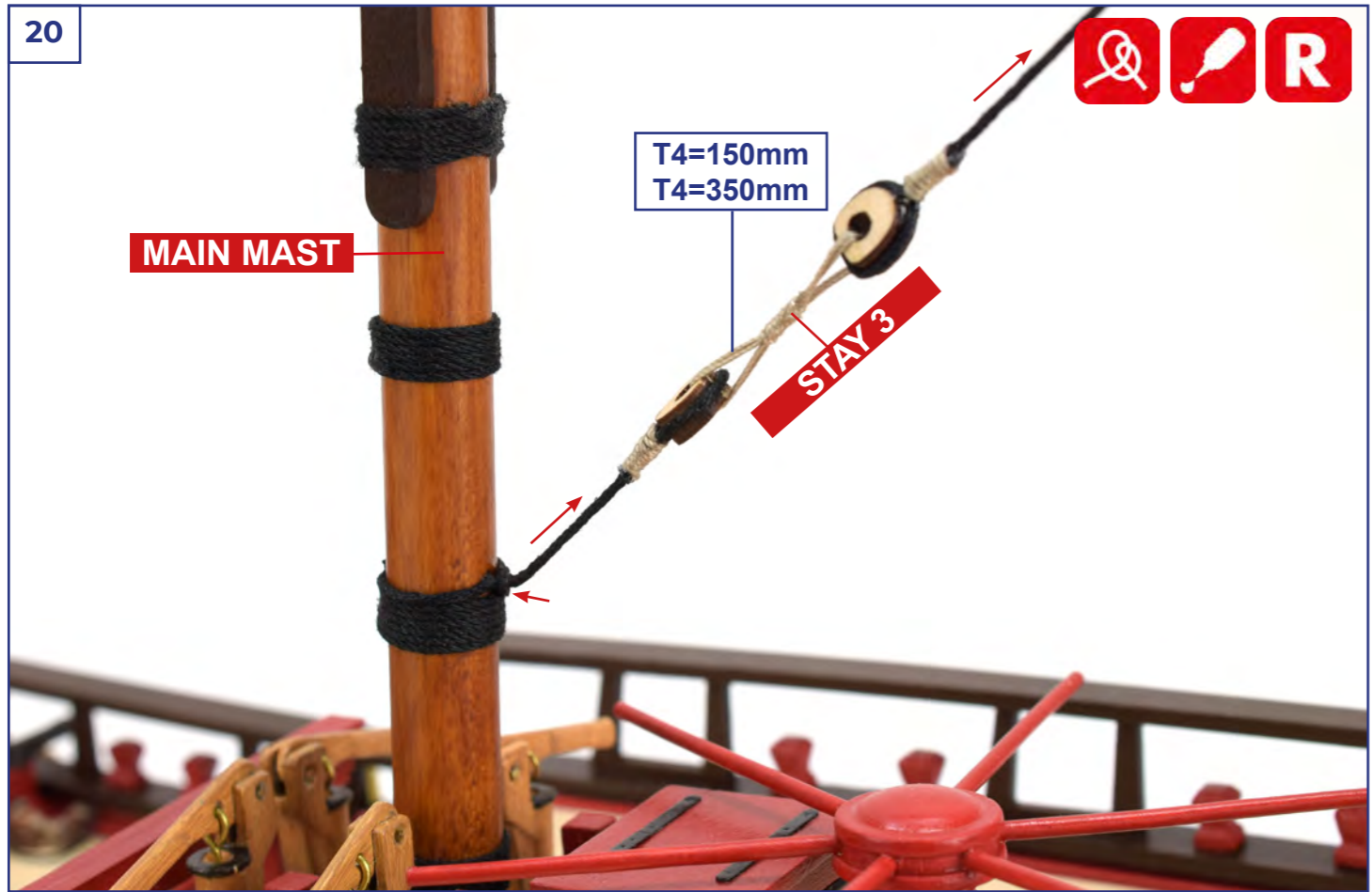

22

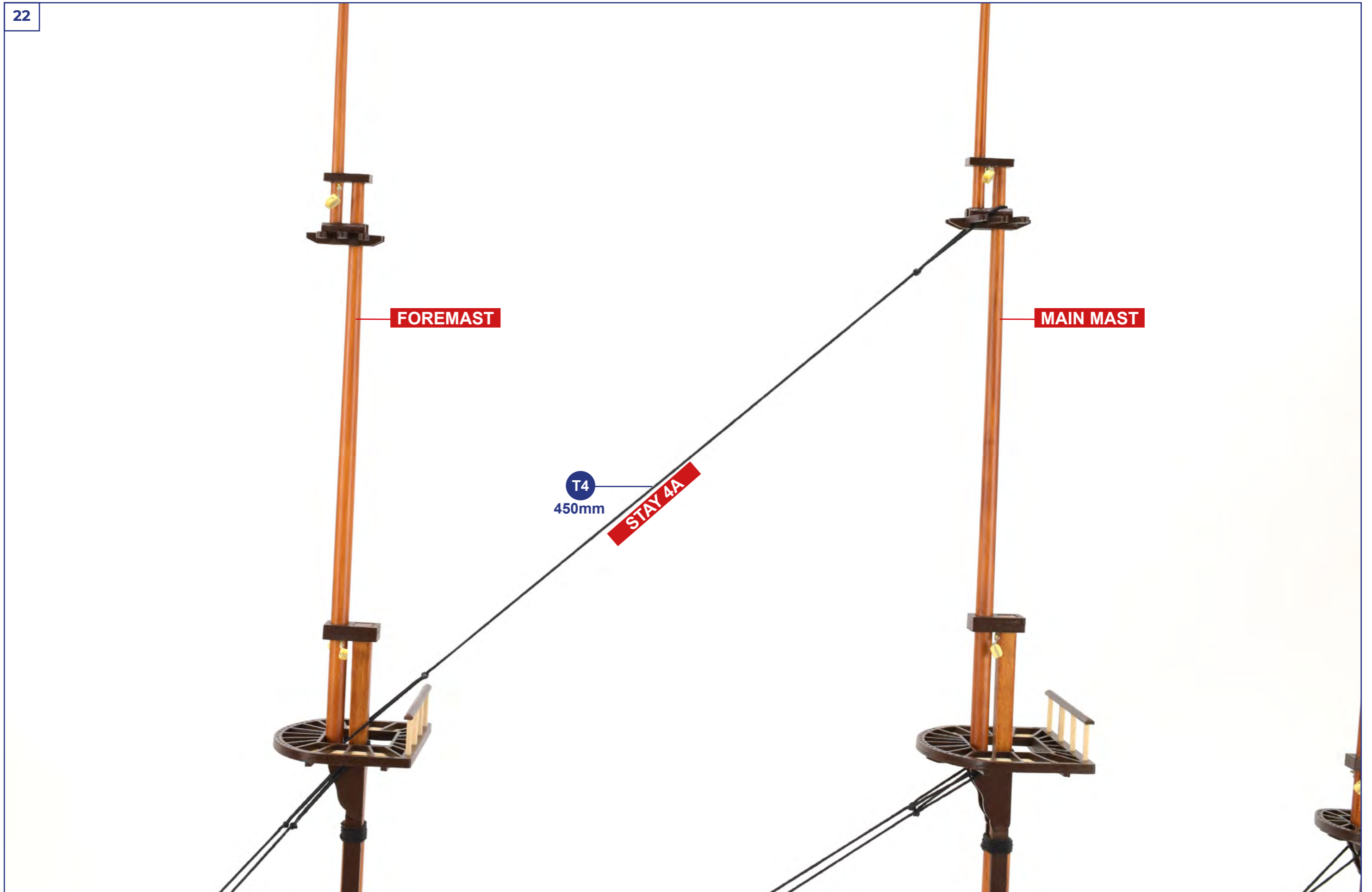

FOREMAST

MAIN MAST

T4
450mm

STAY 4A

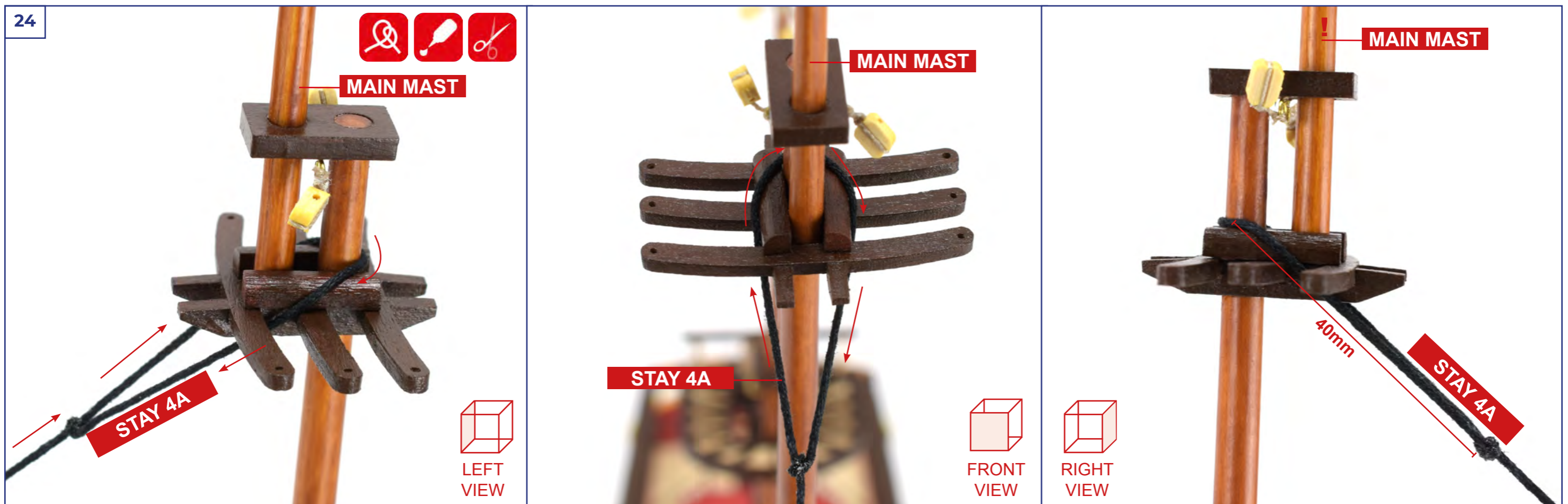

25



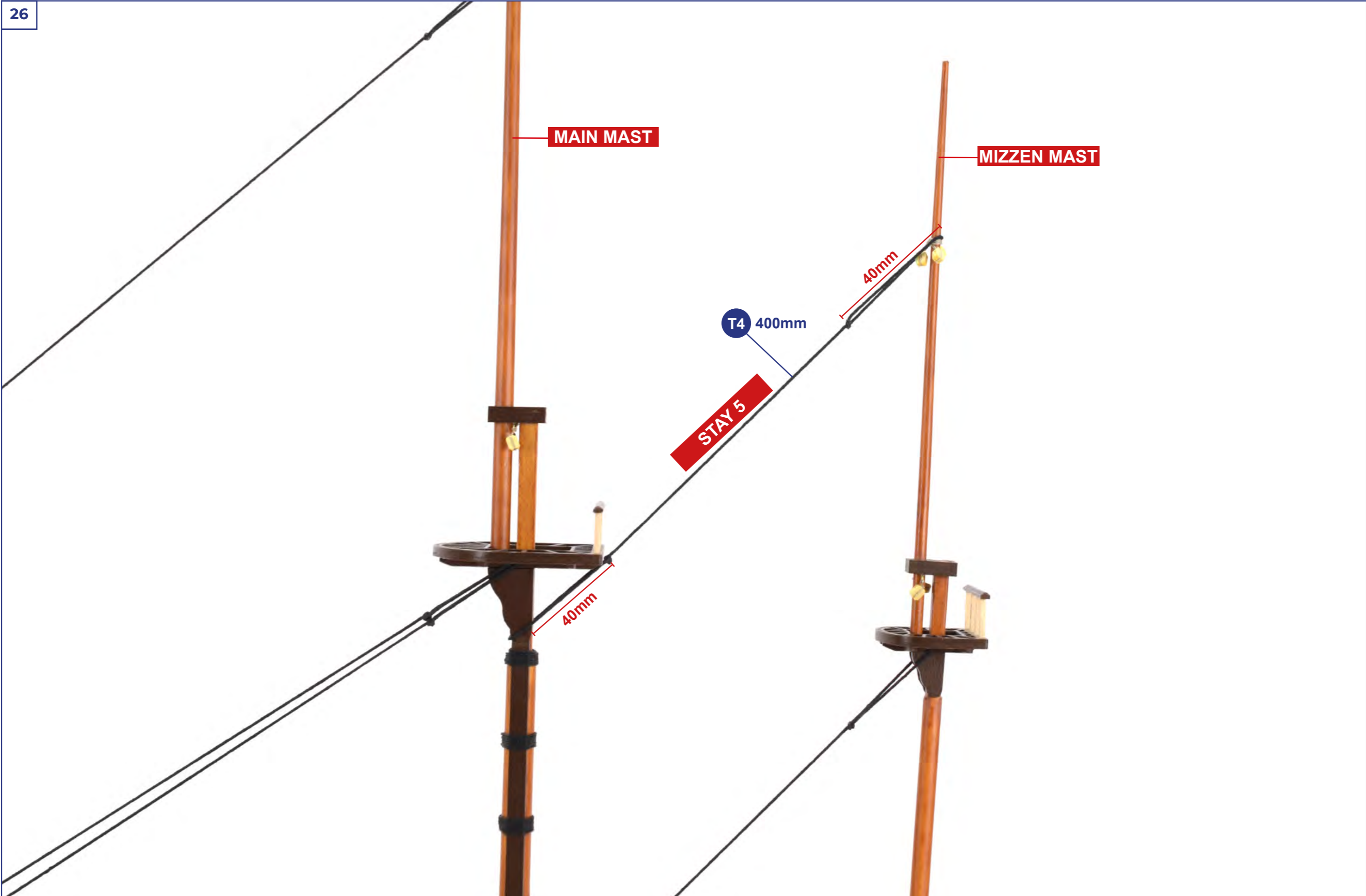

27

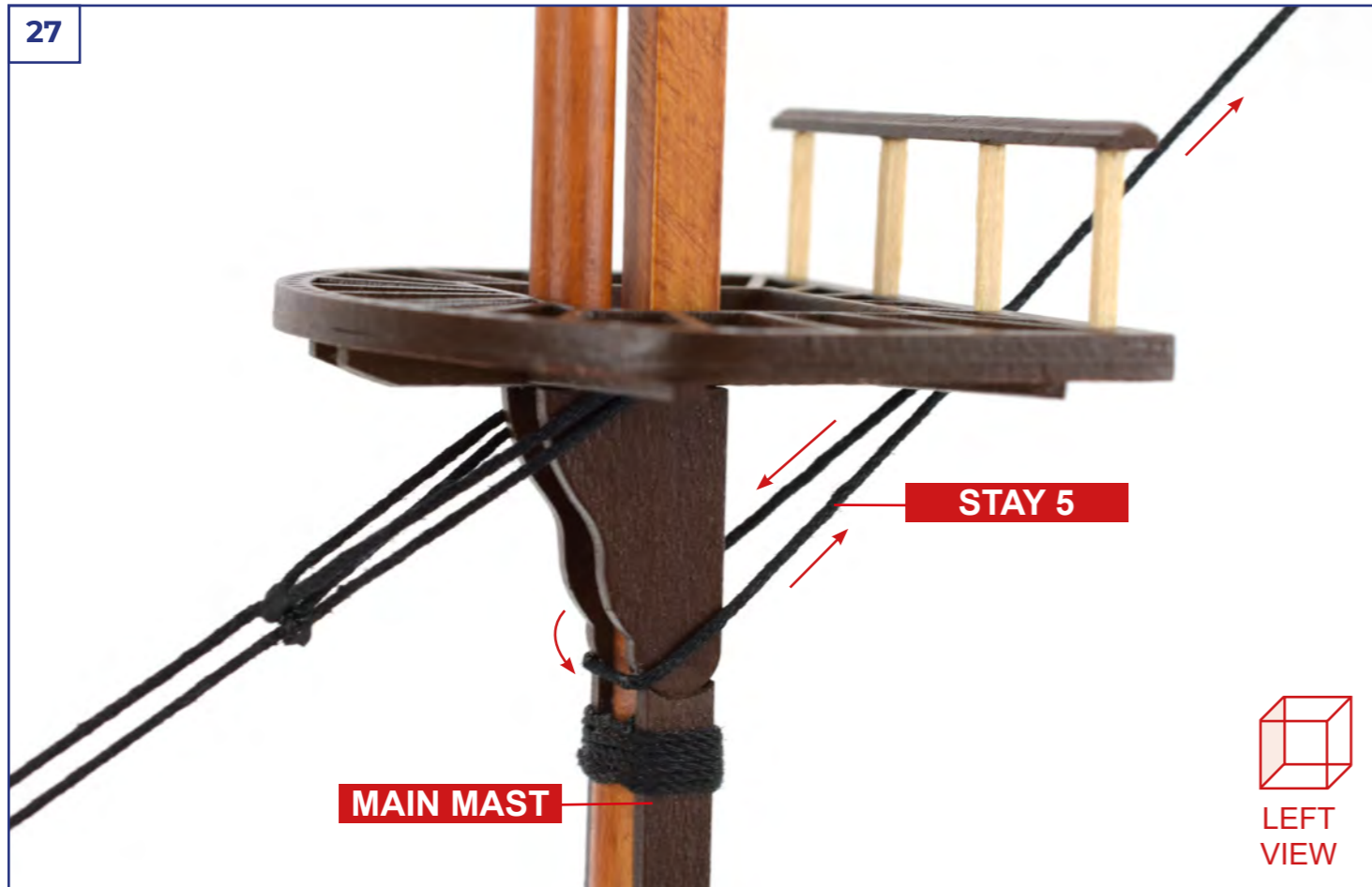

28

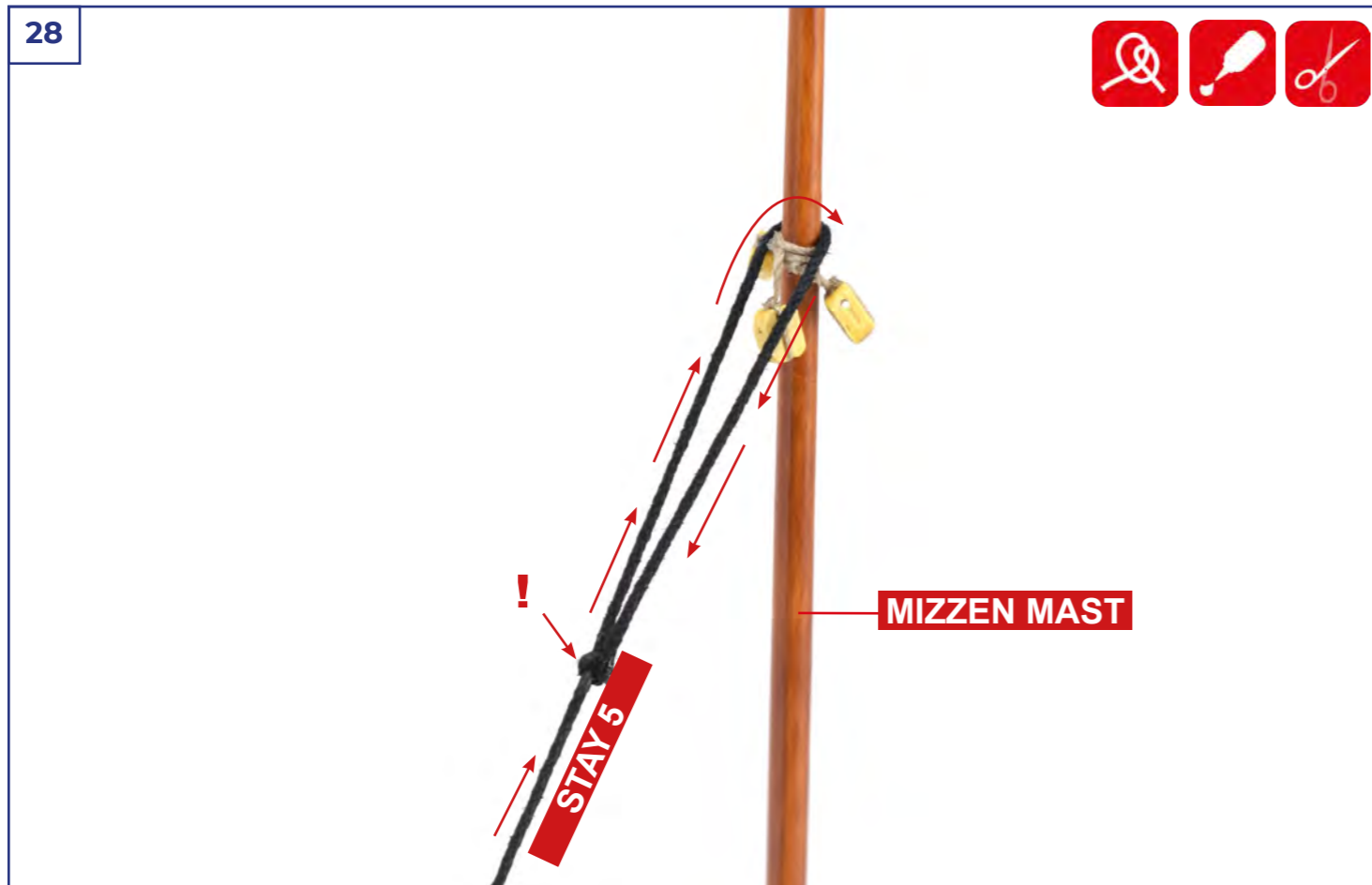

29



30

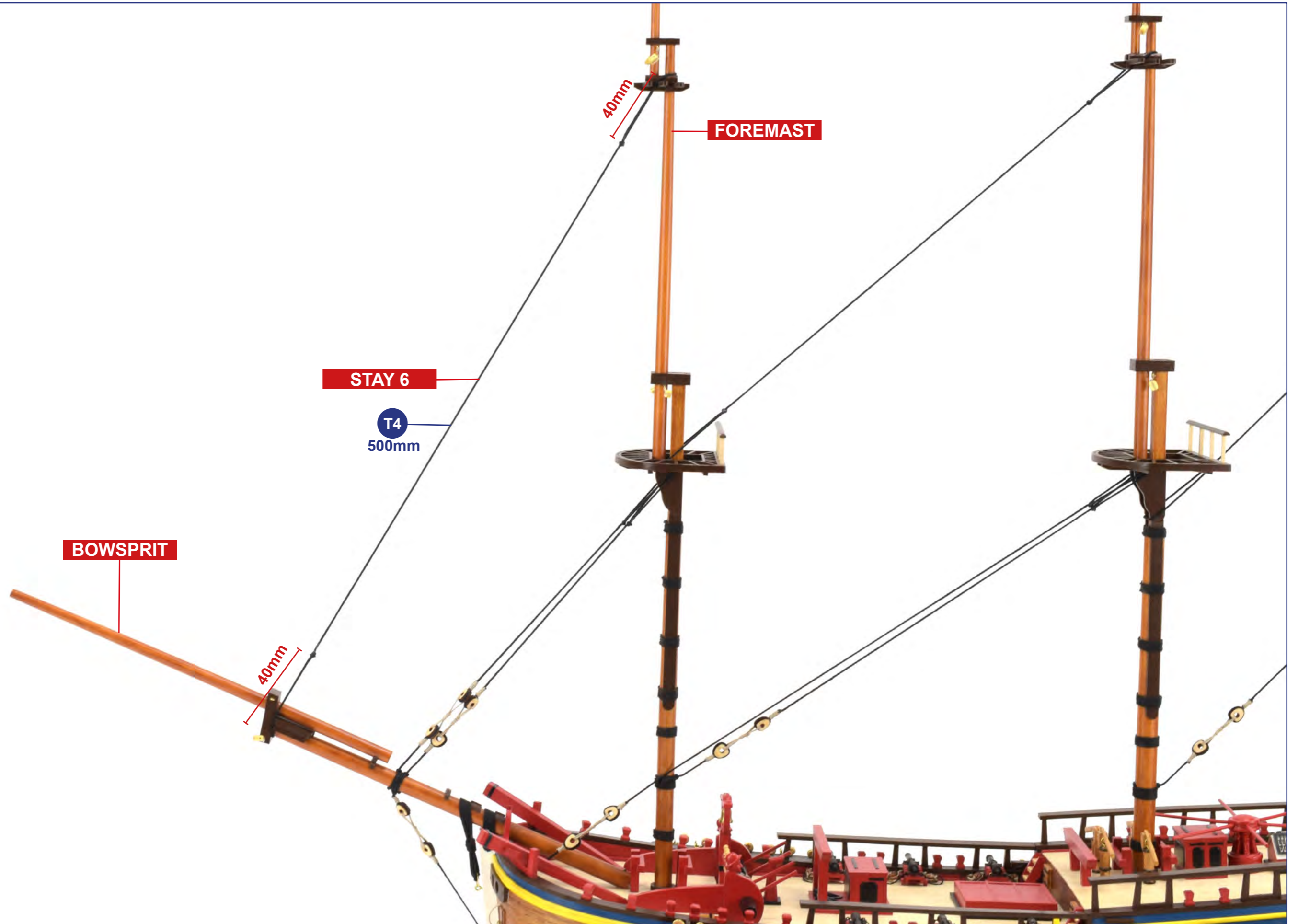

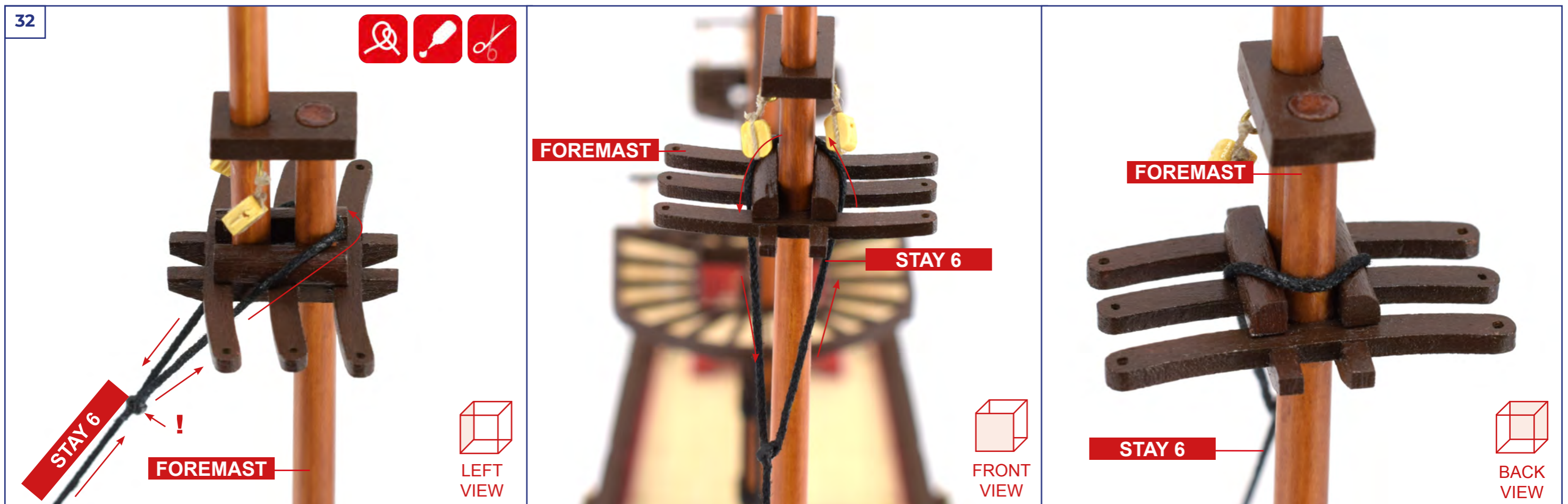
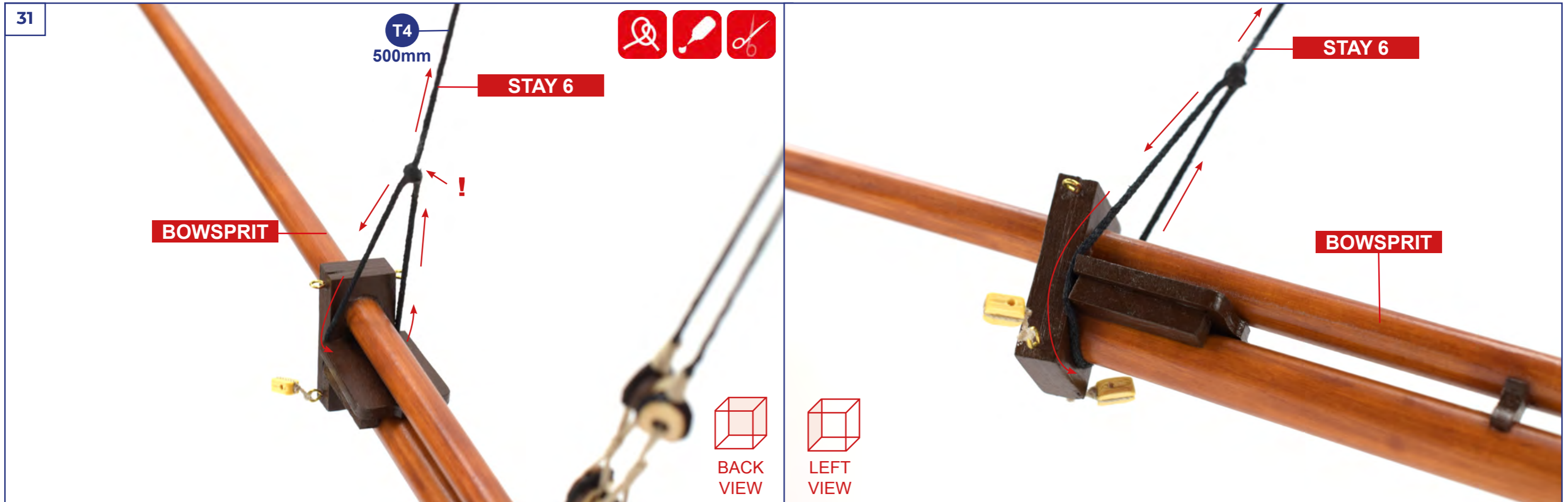

33



34

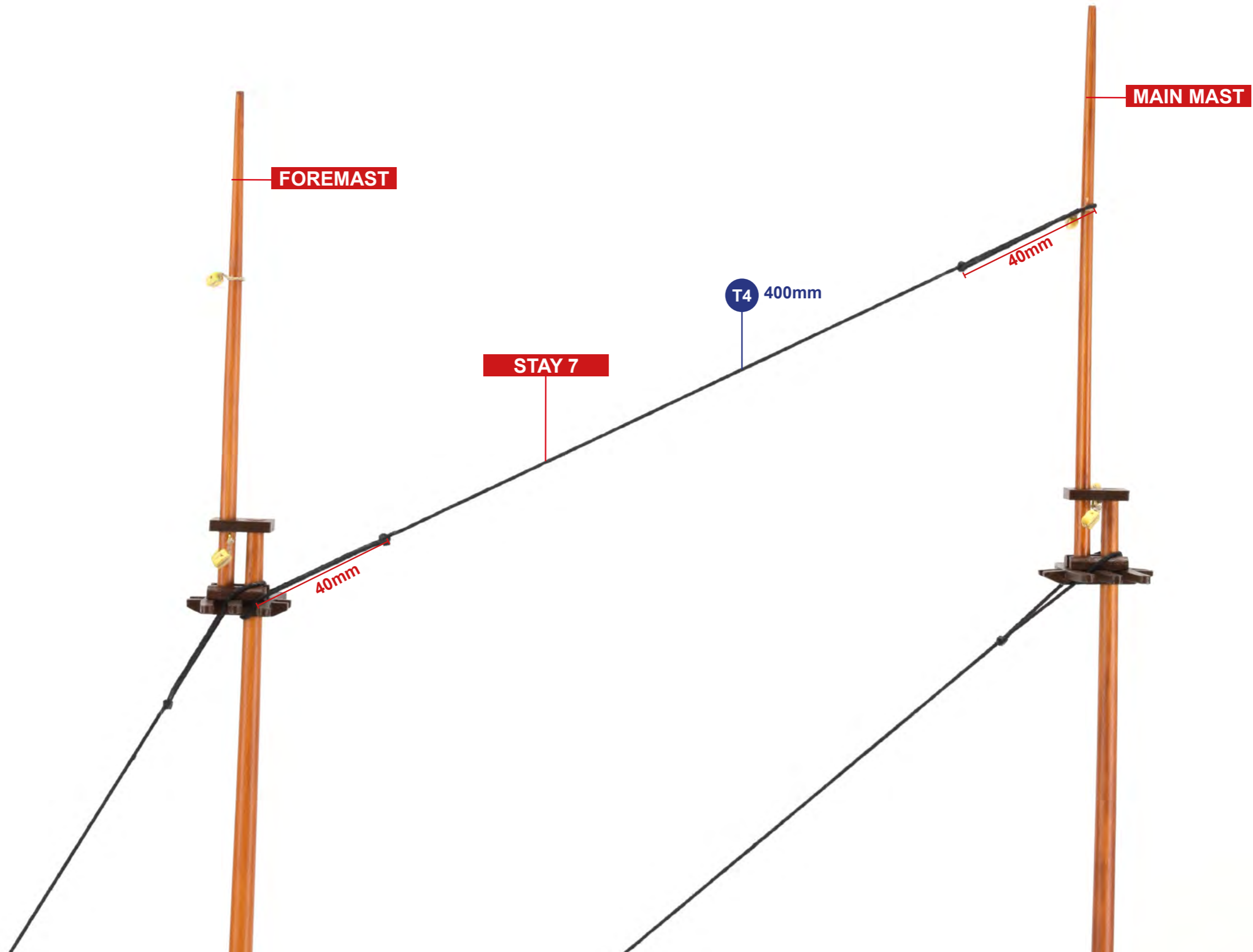

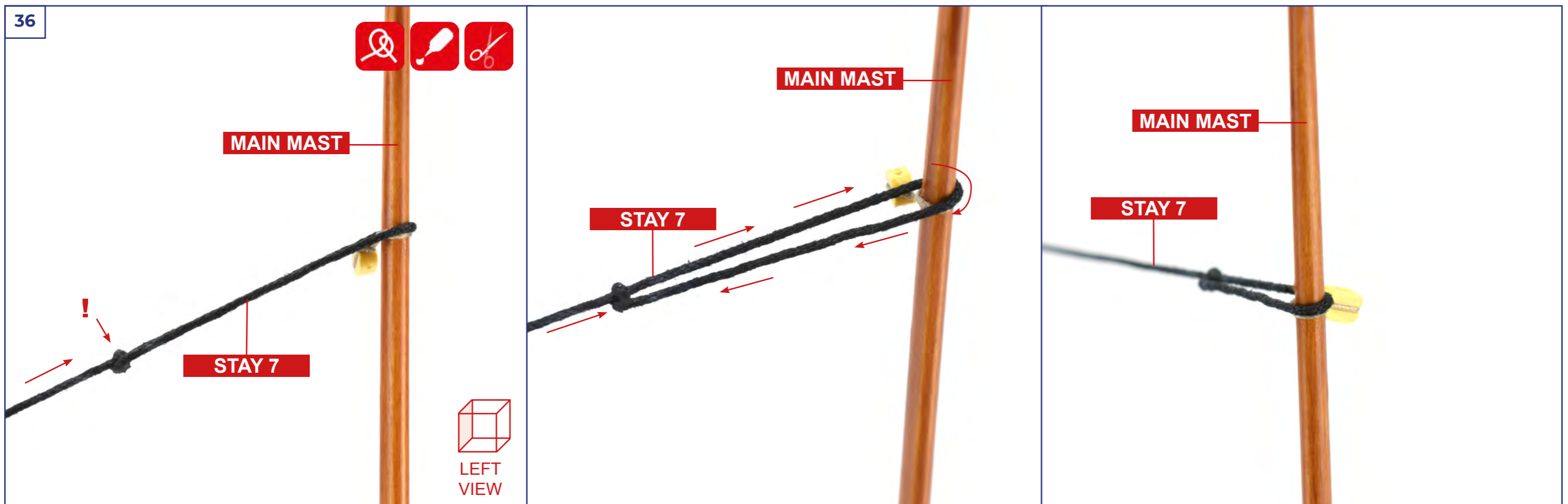
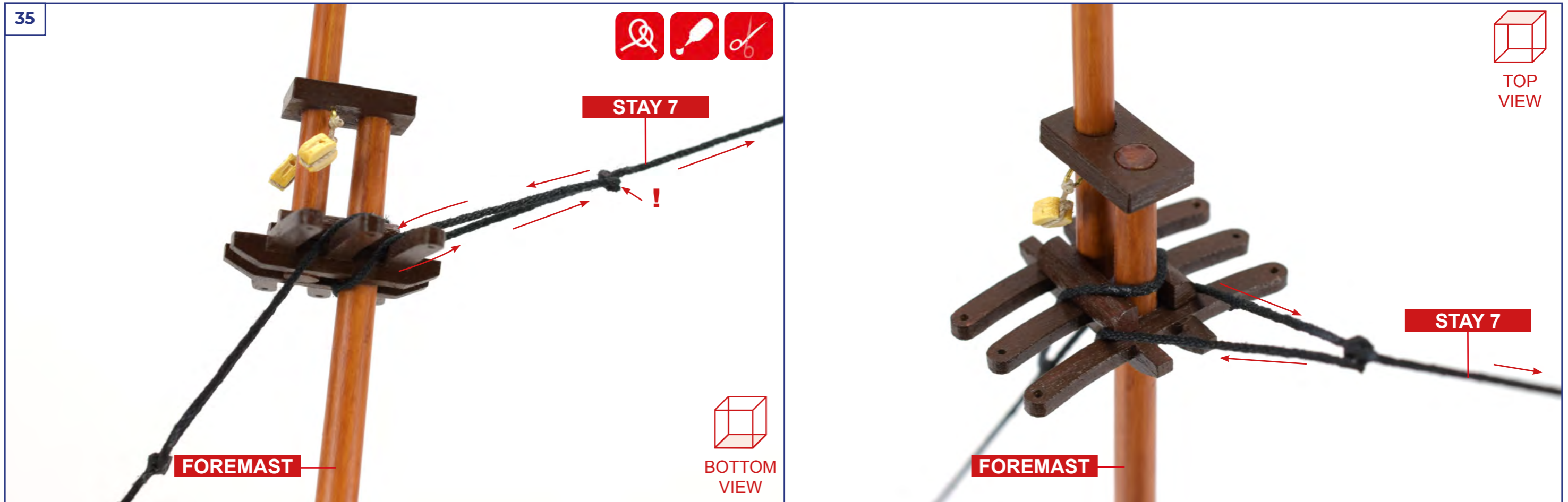

37



38

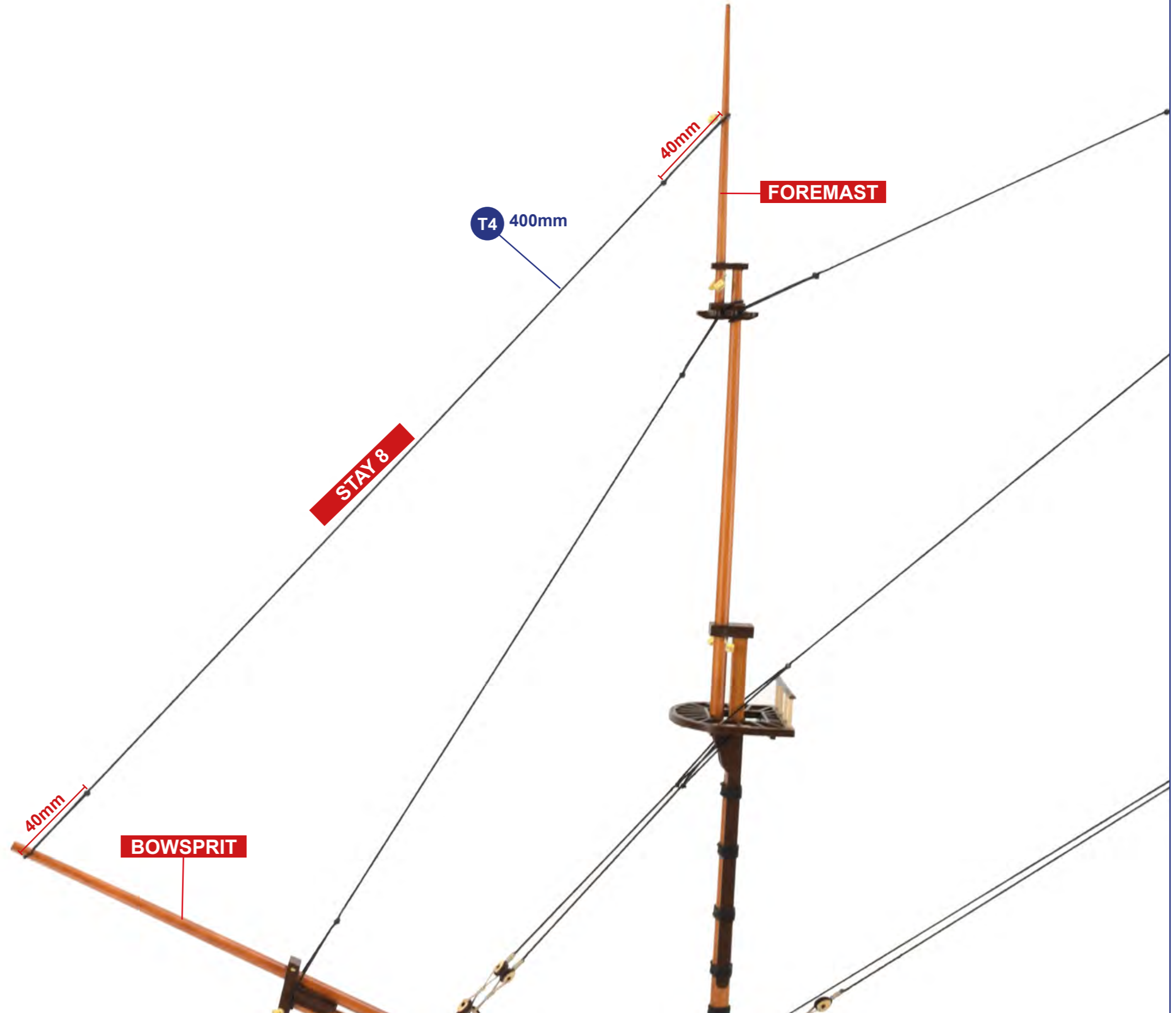

39

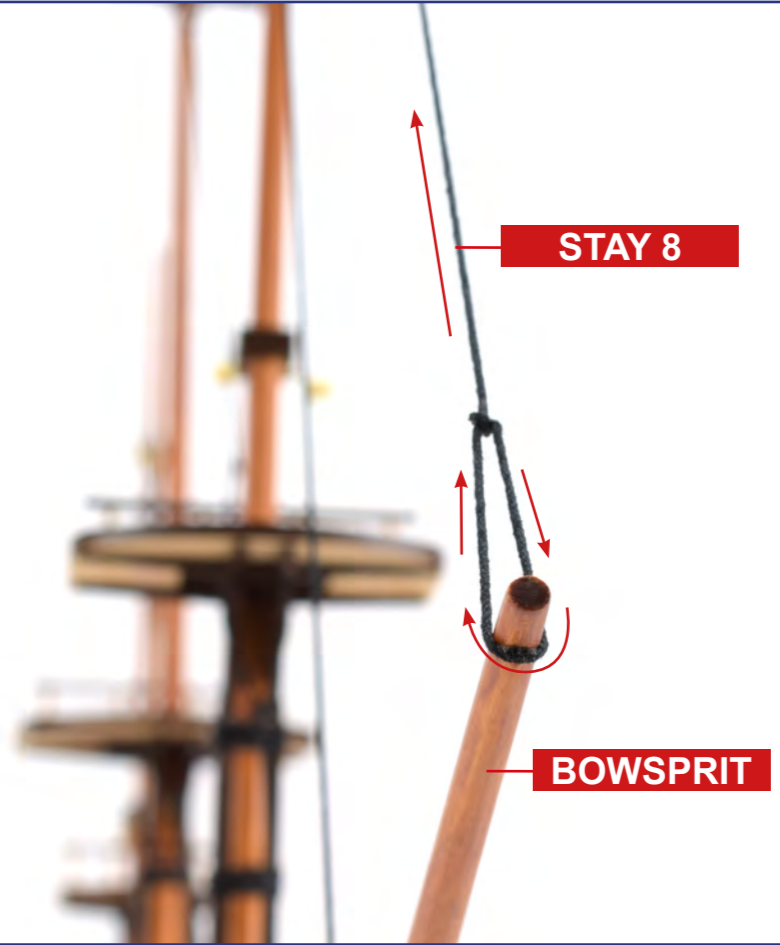

40

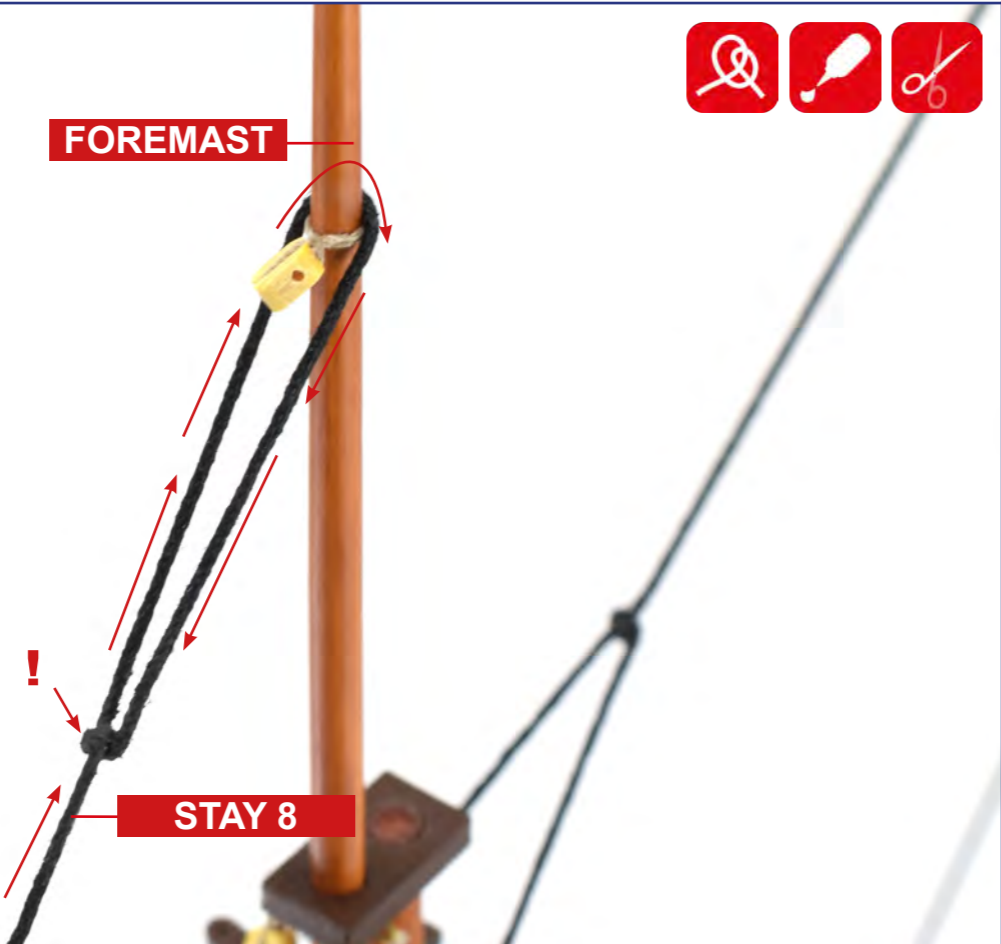

41

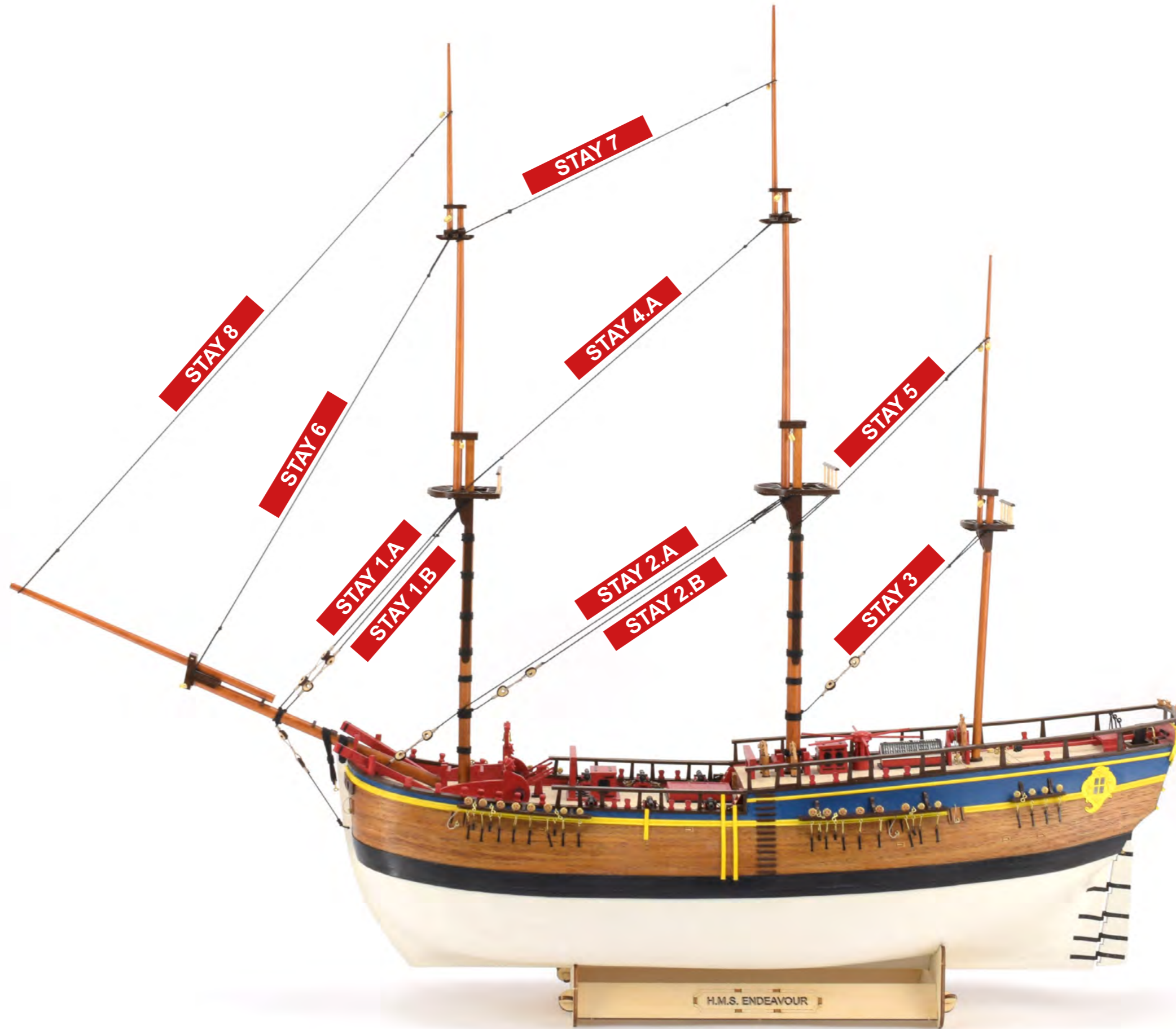

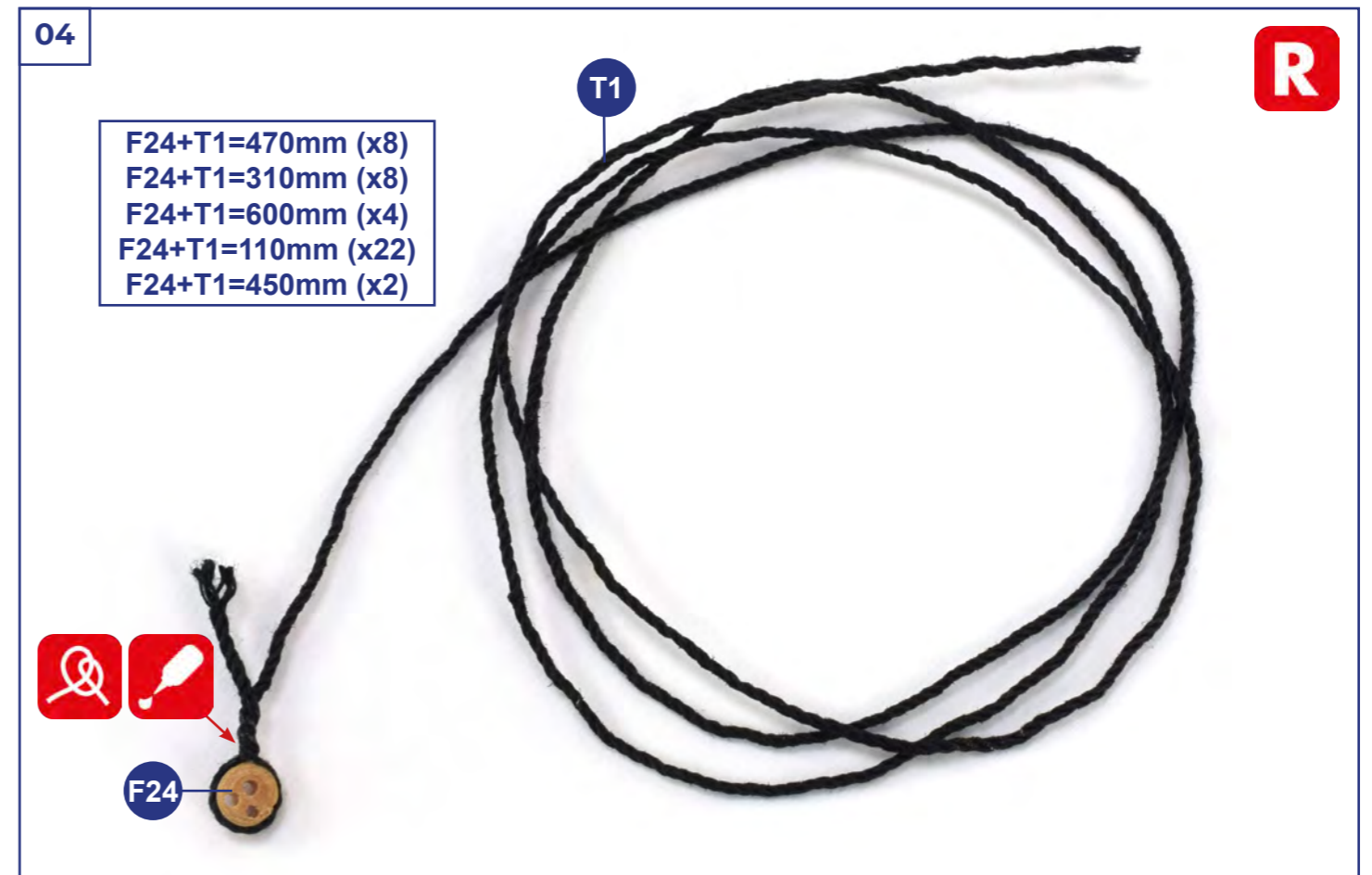
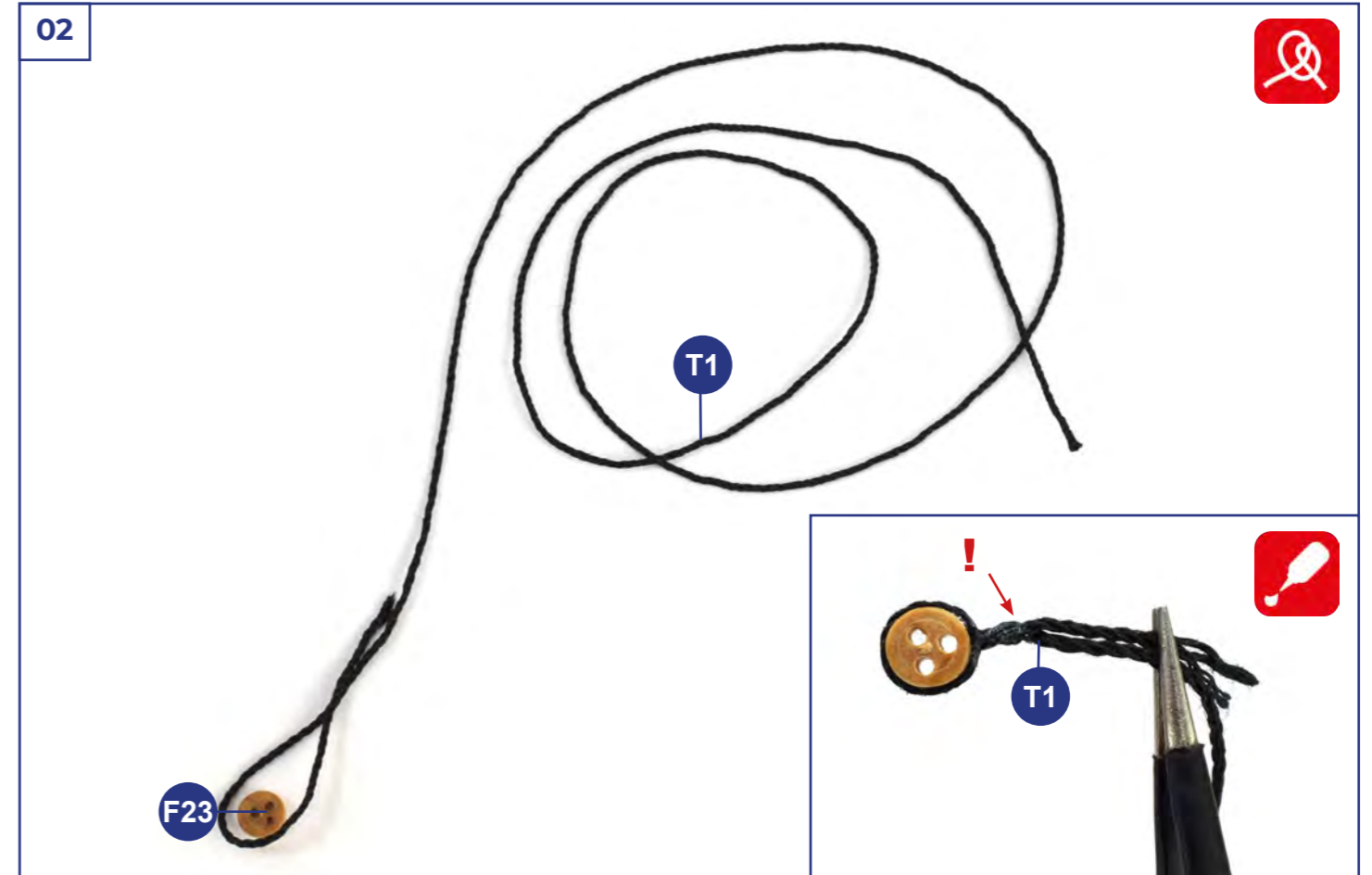

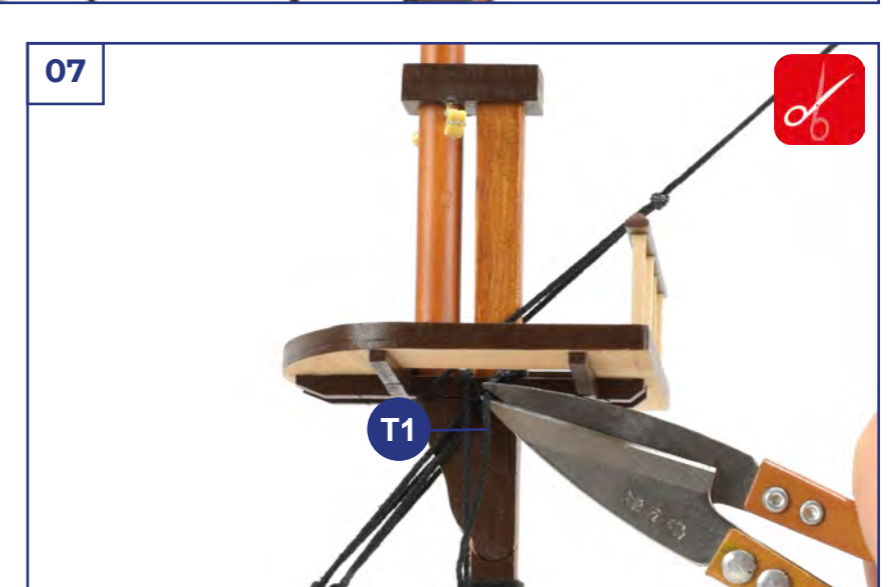
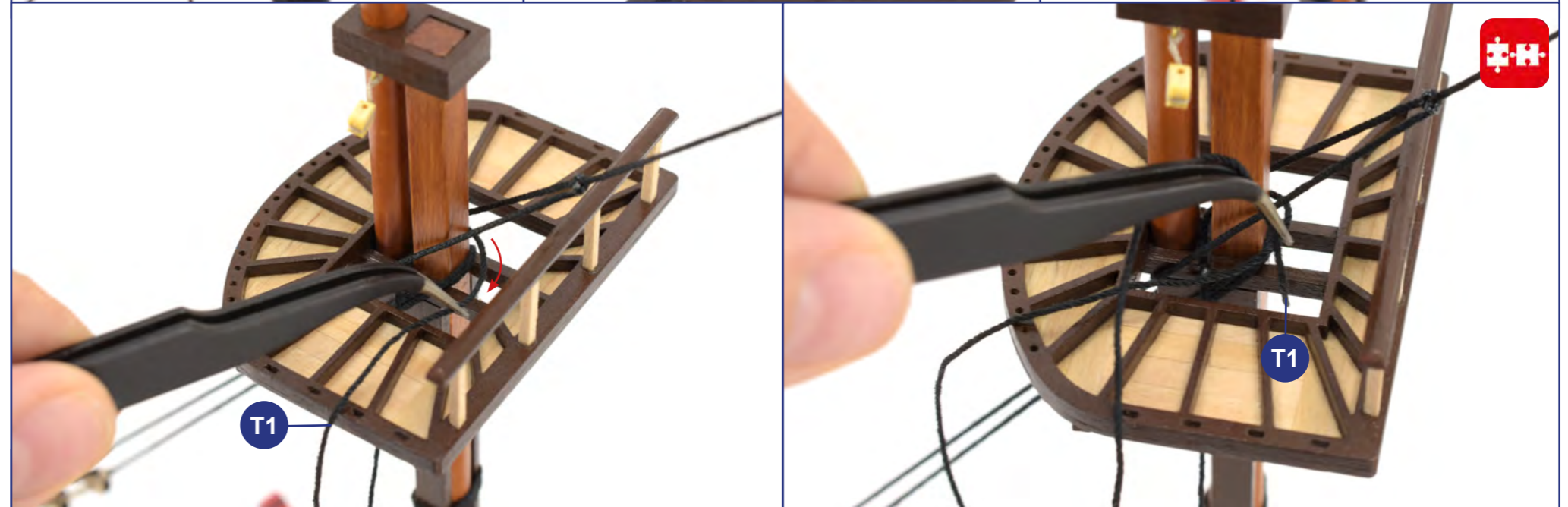
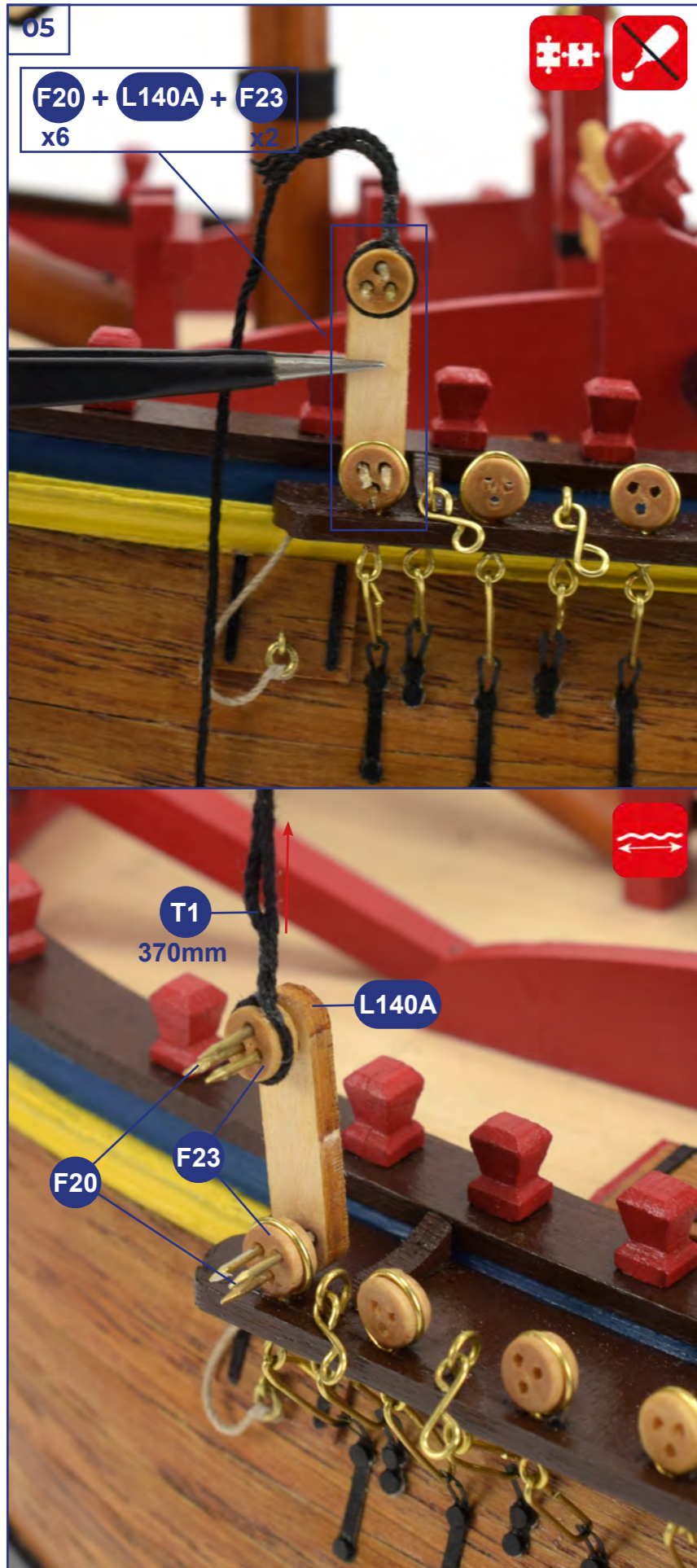



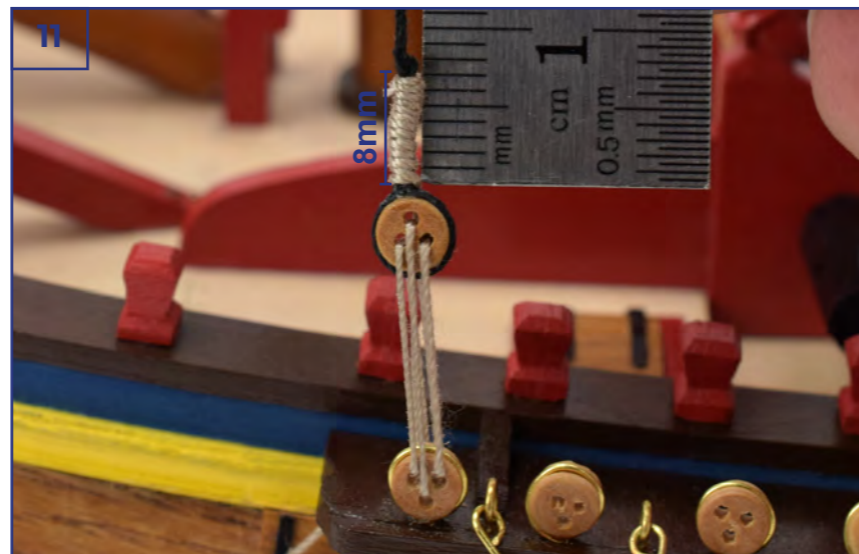
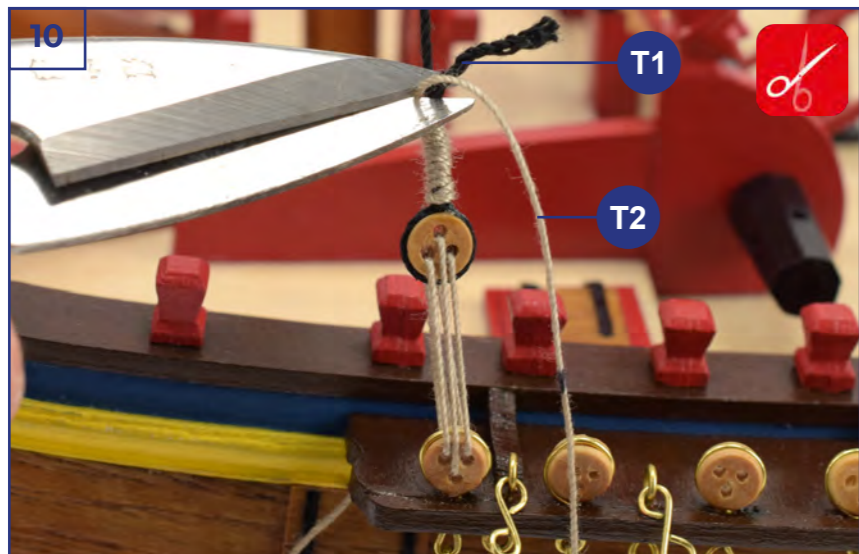
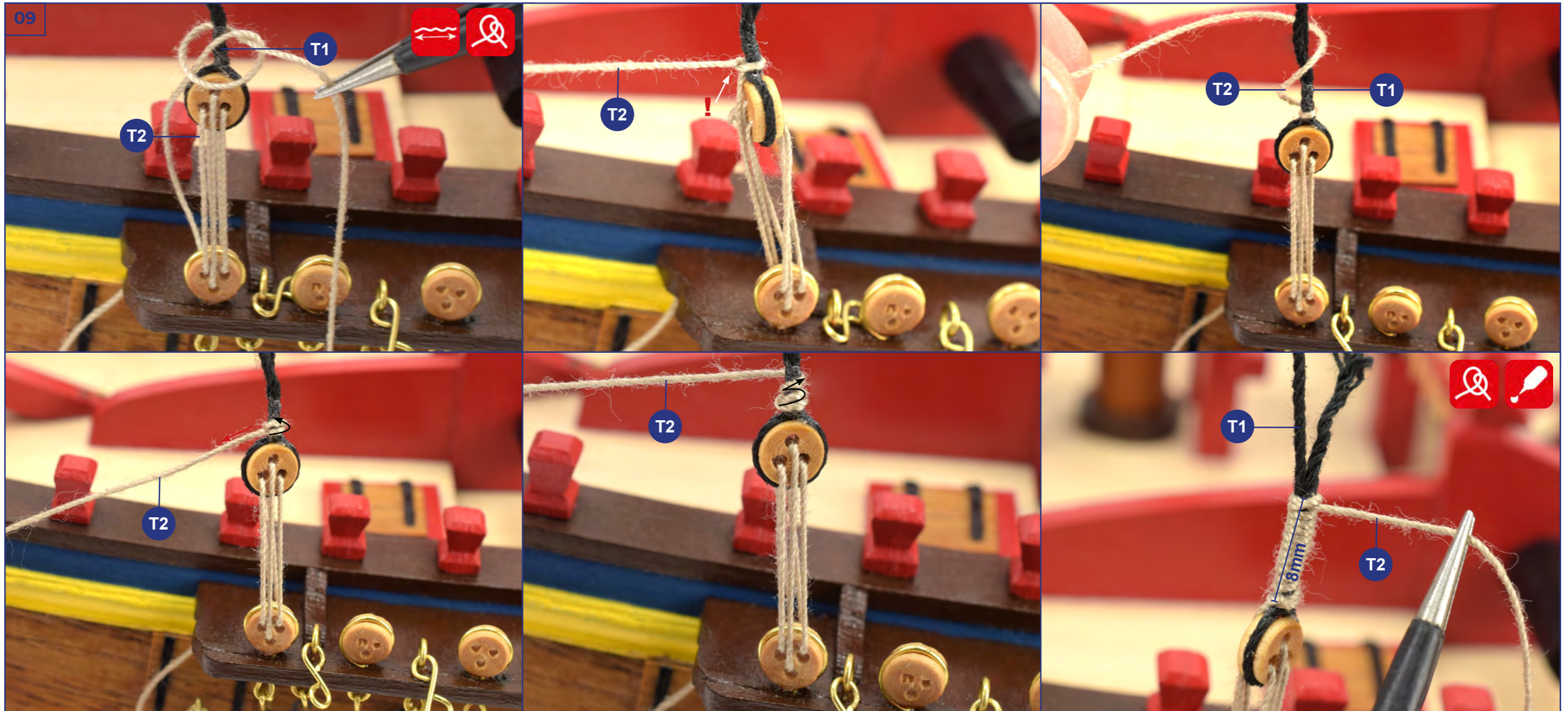

13

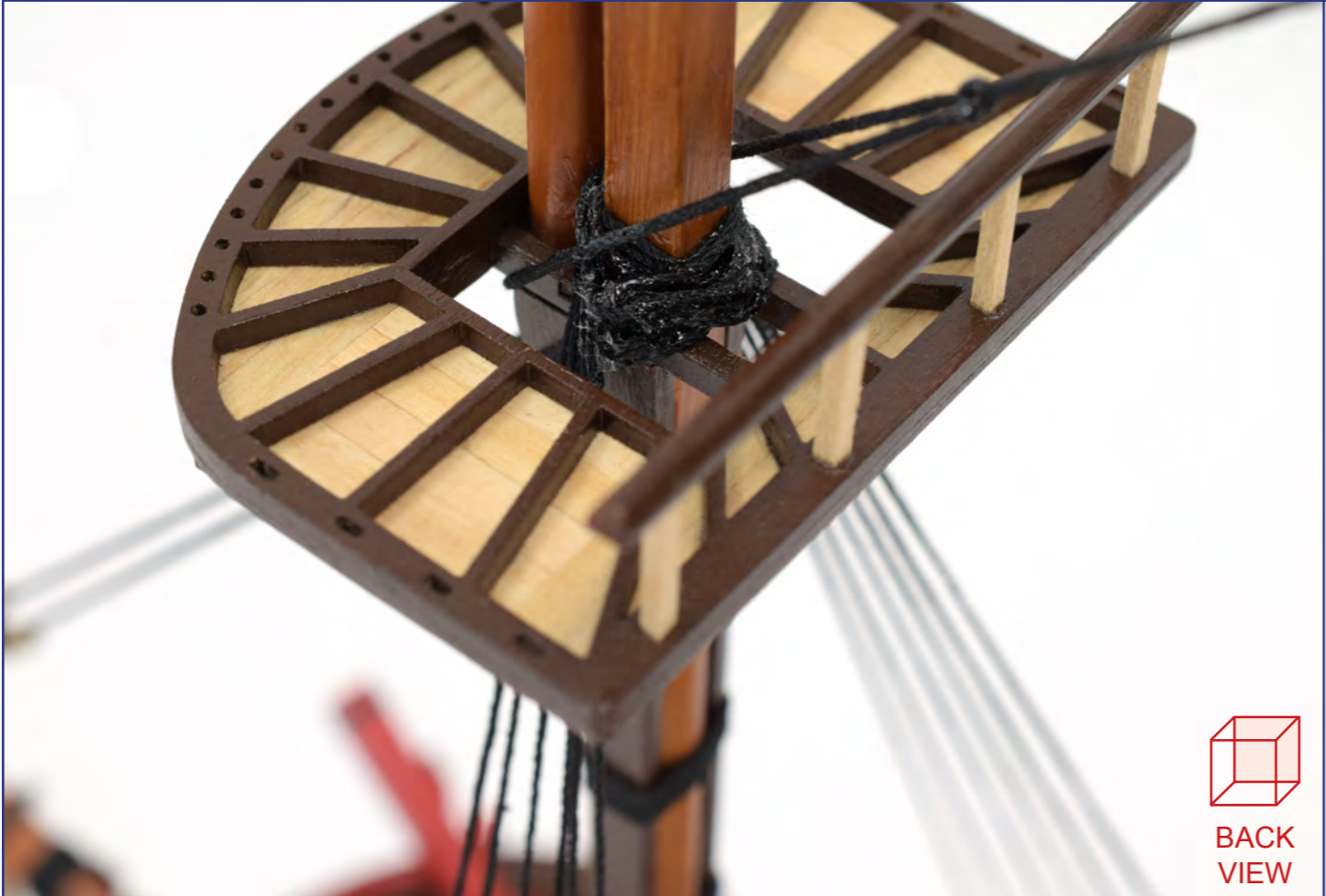

15



LEFT
VIEW

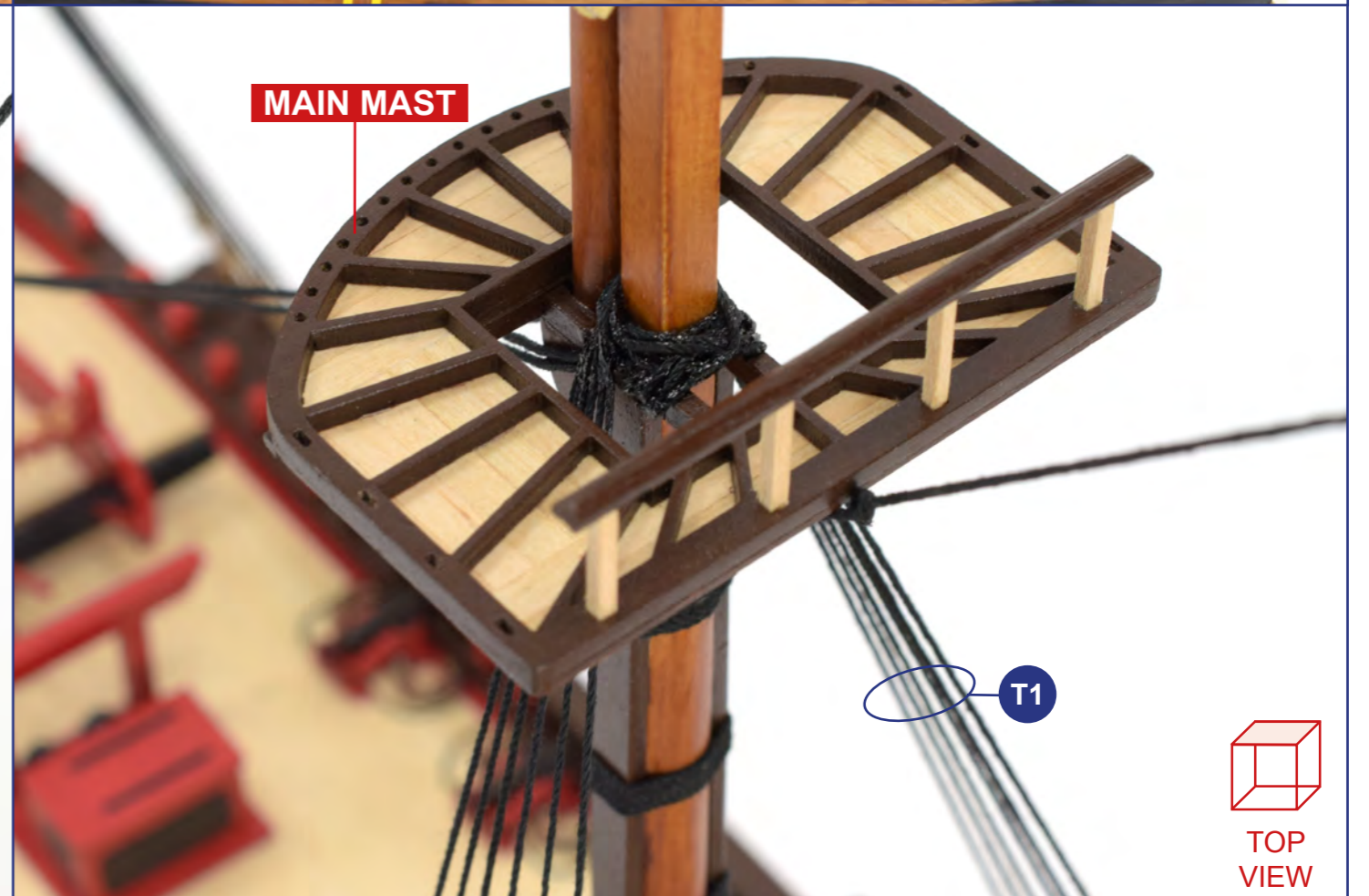
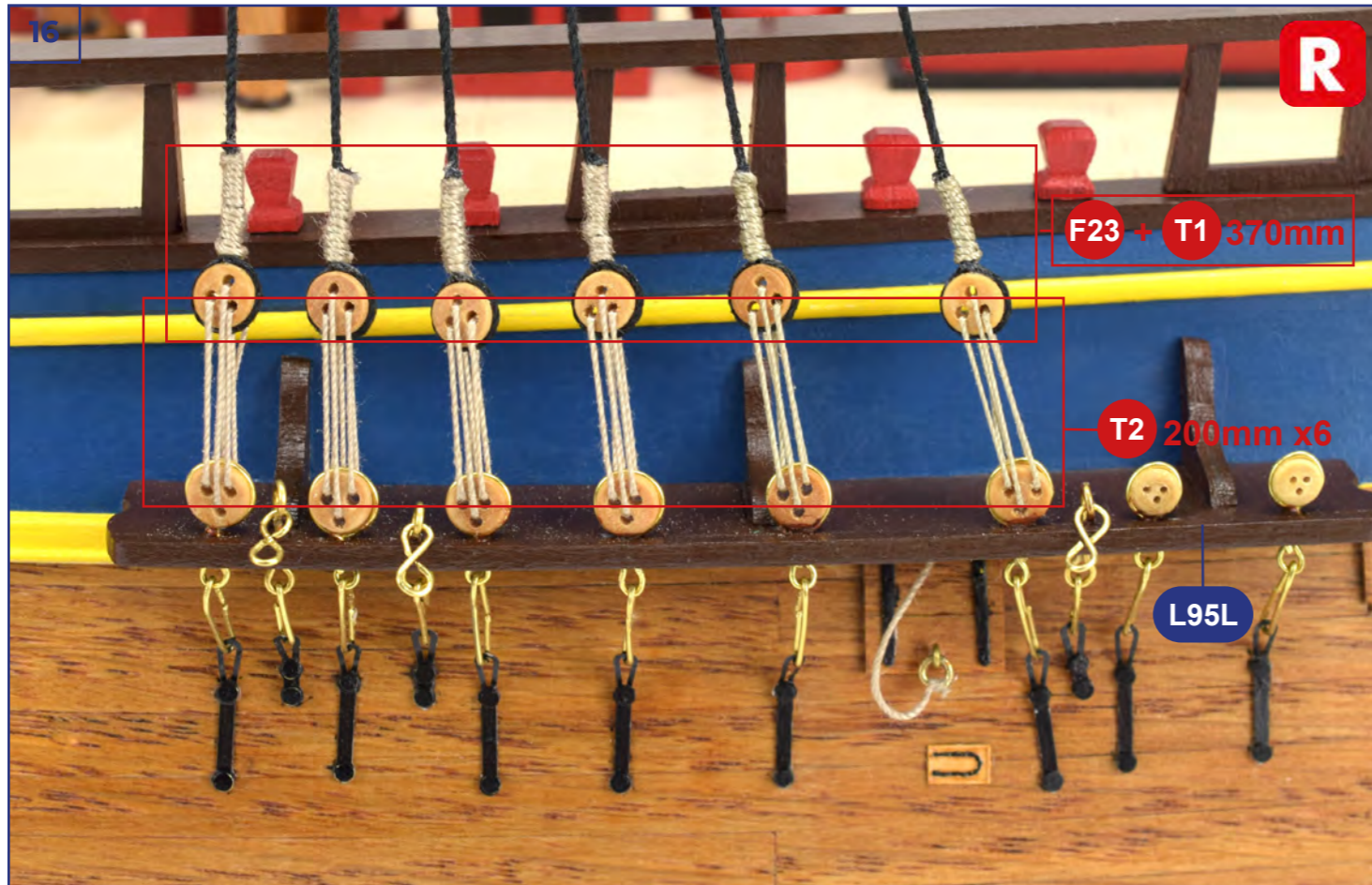

17



LEFT
VIEW

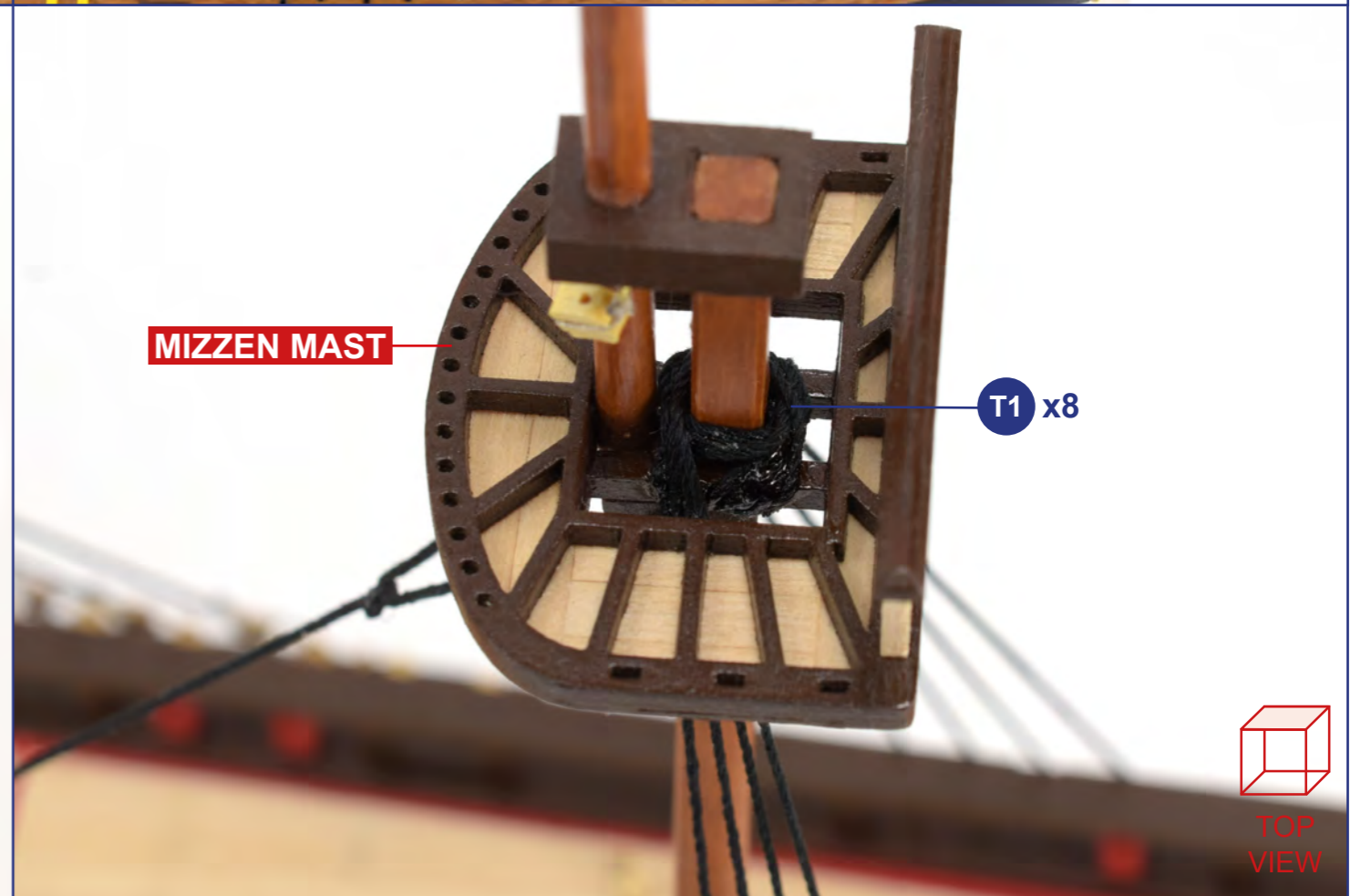
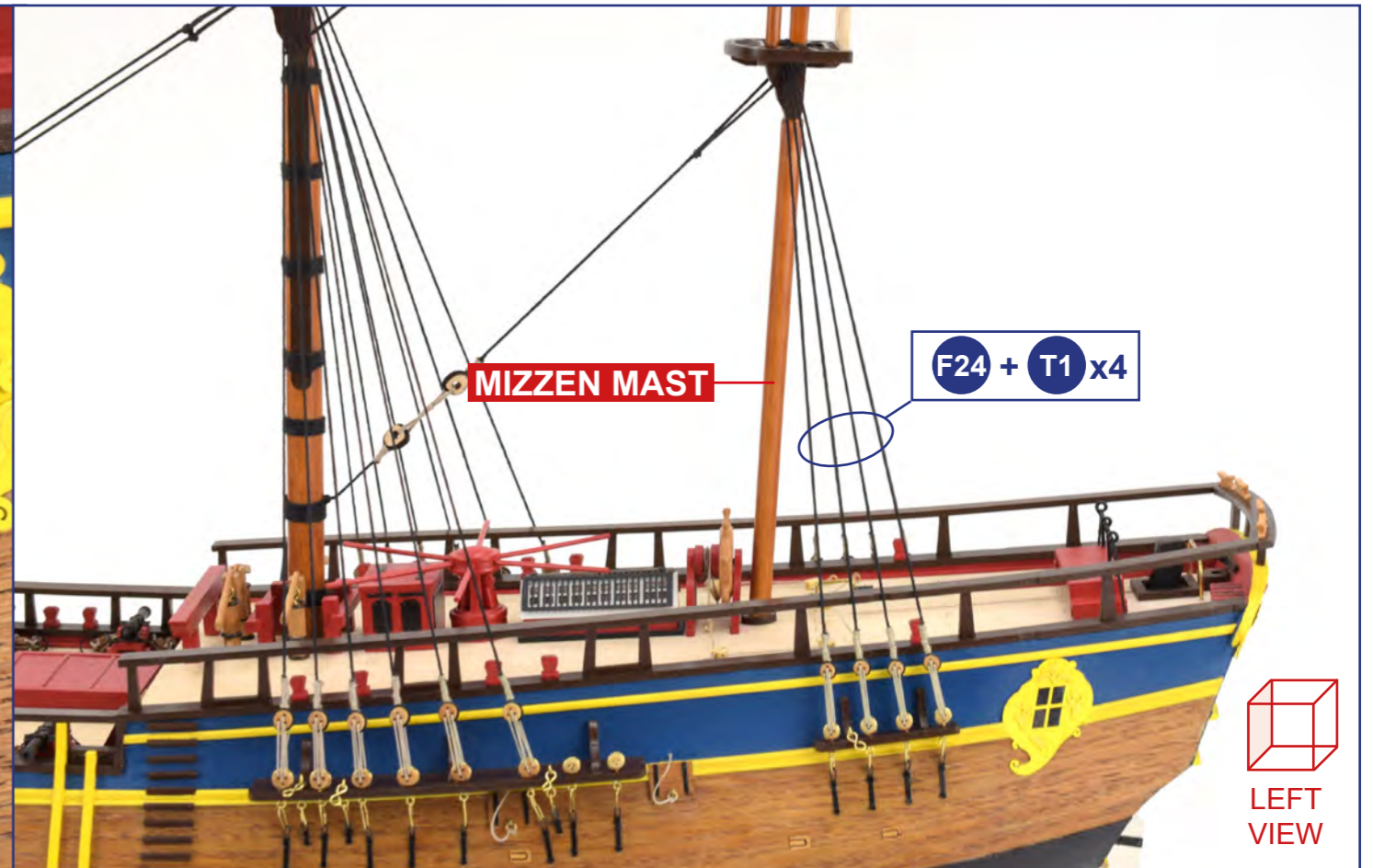
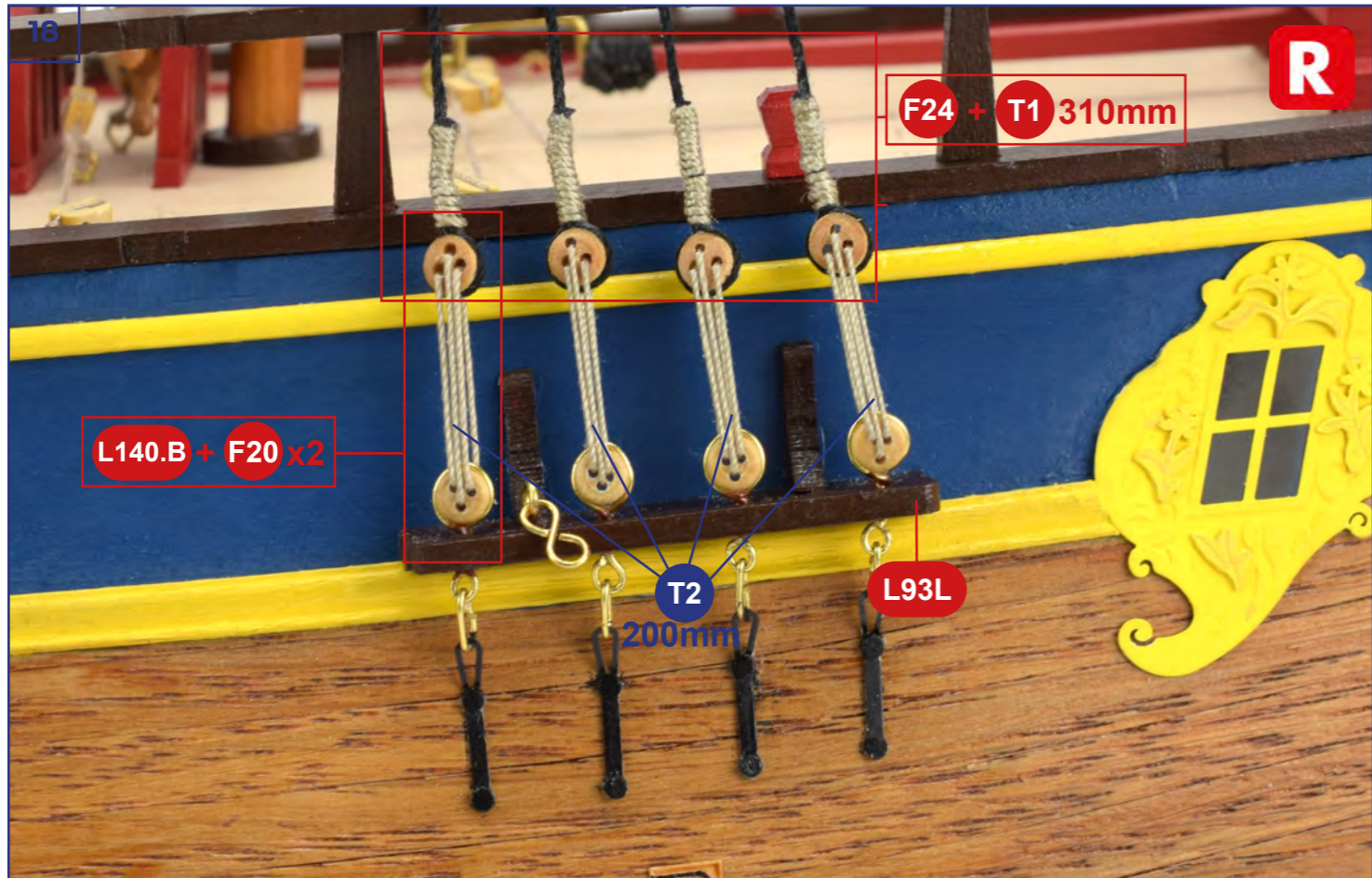

19



LEFT
VIEW

20

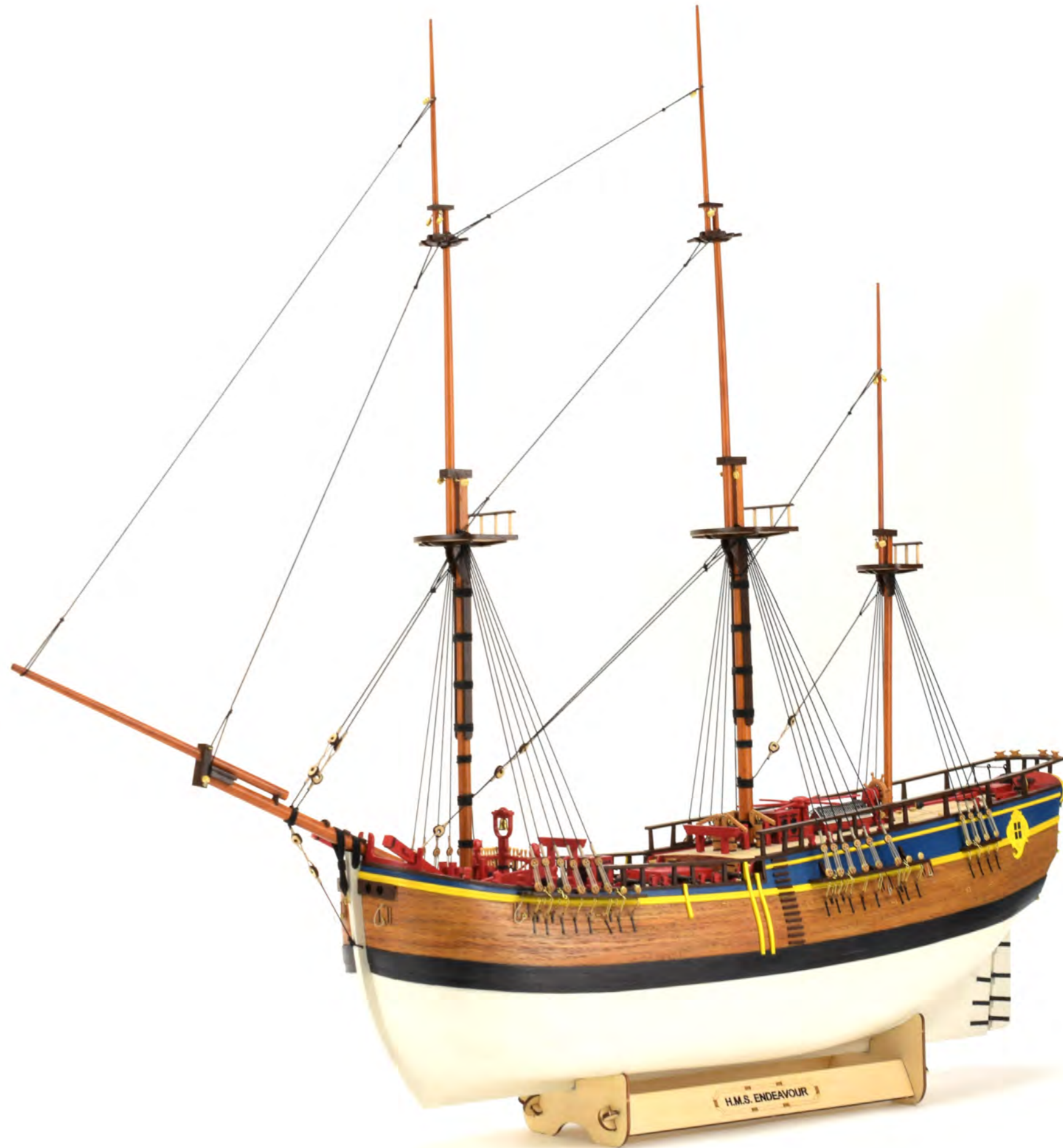

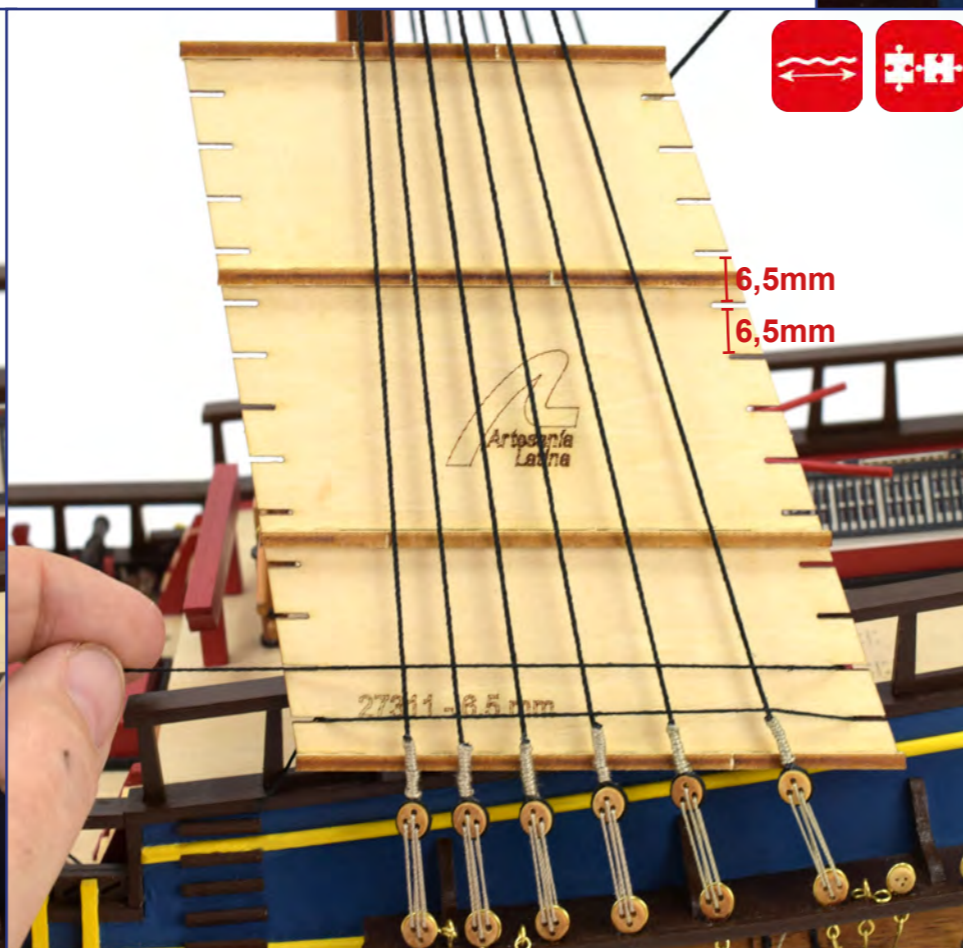
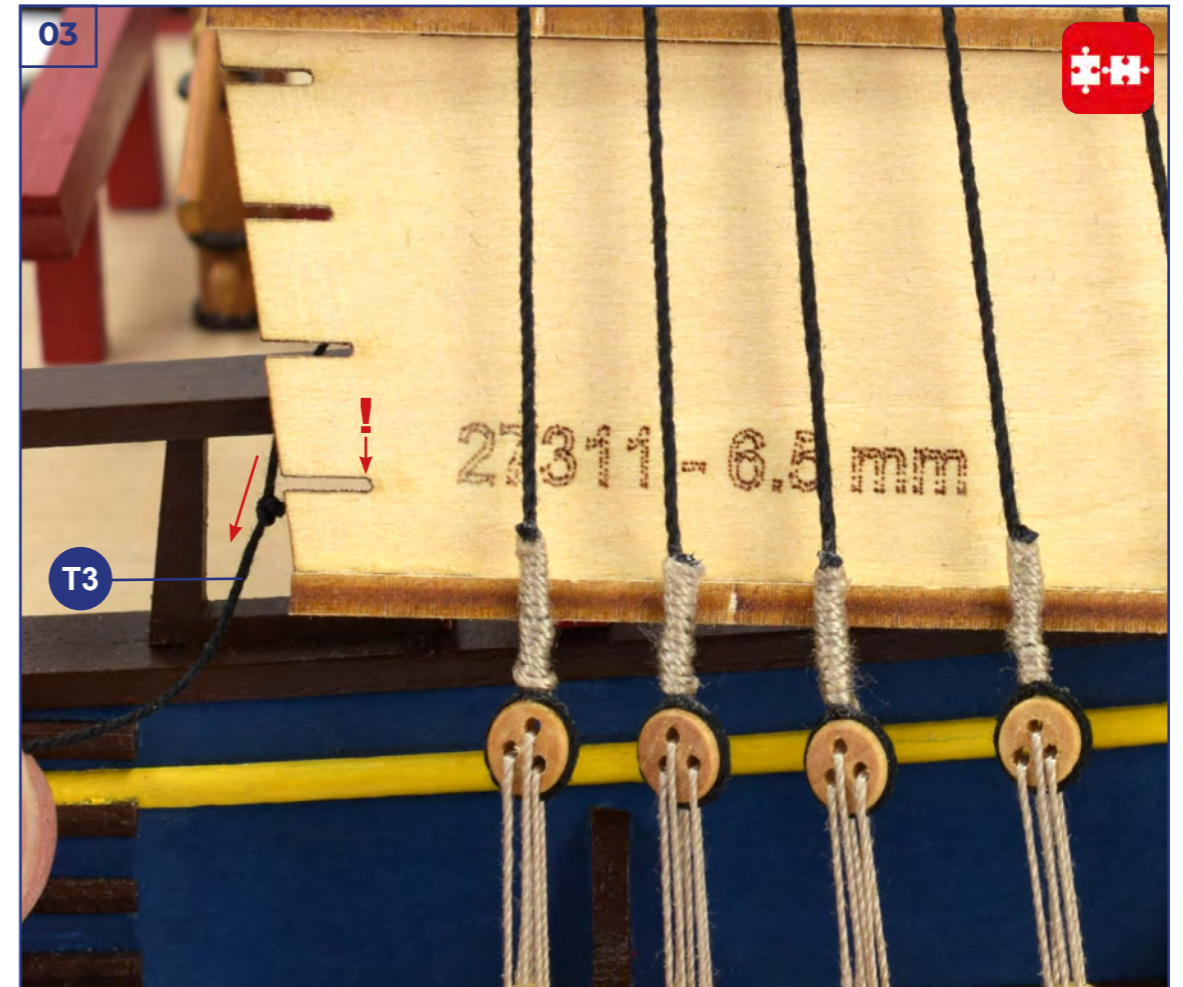
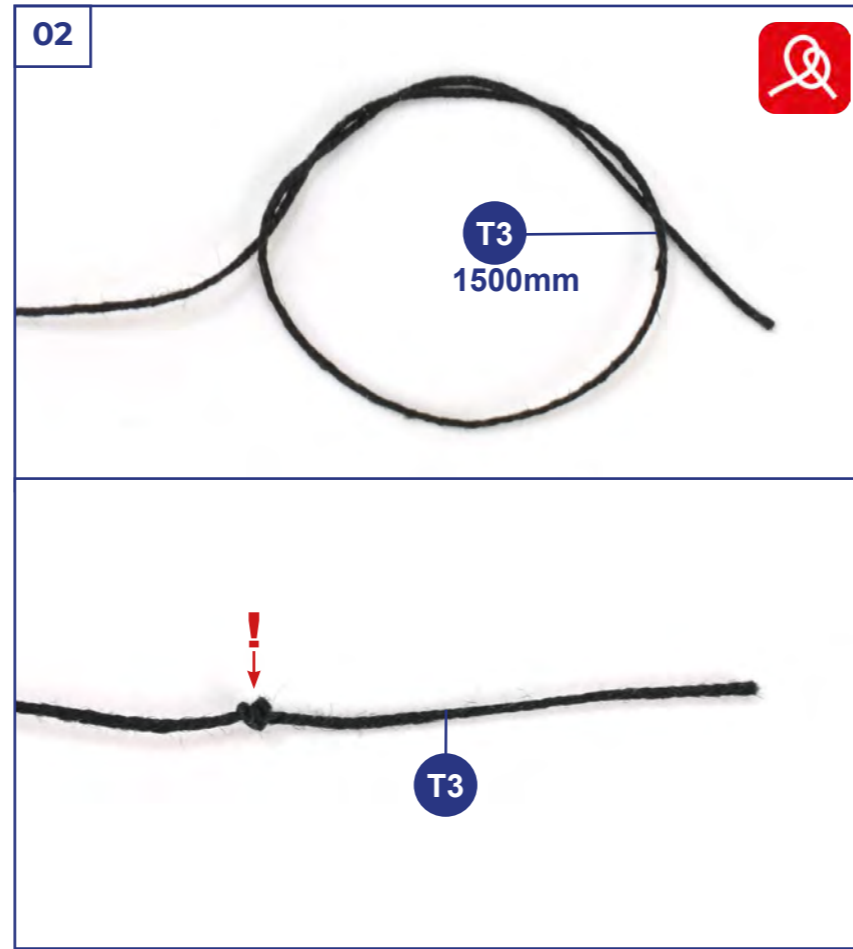
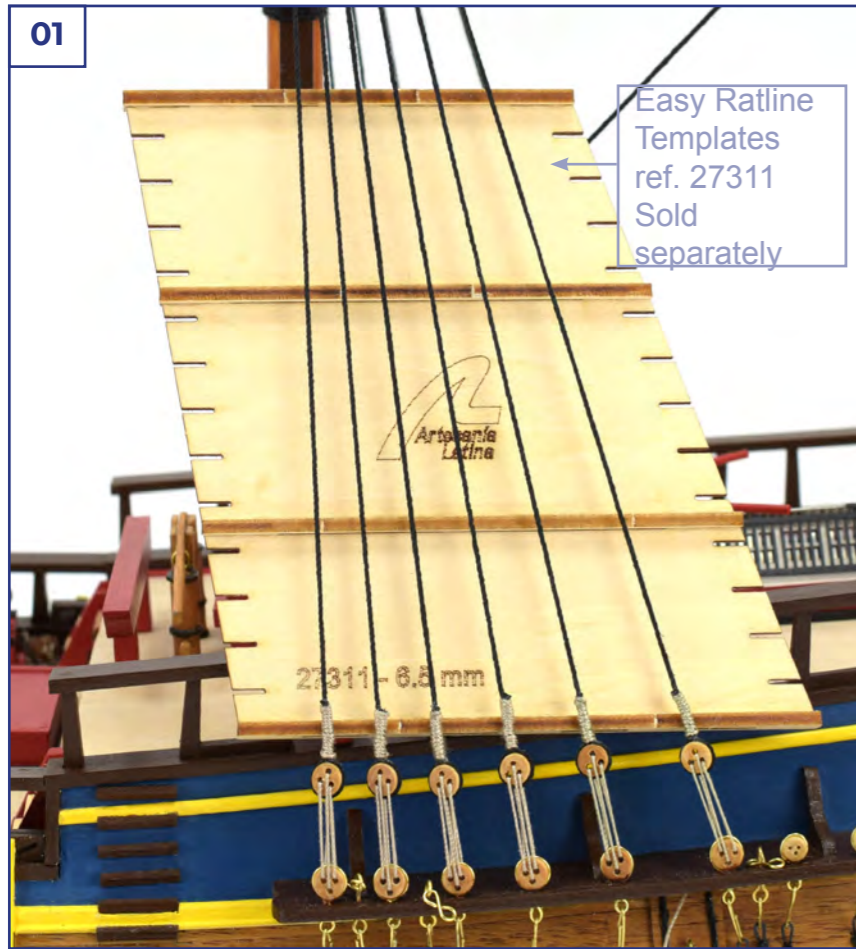

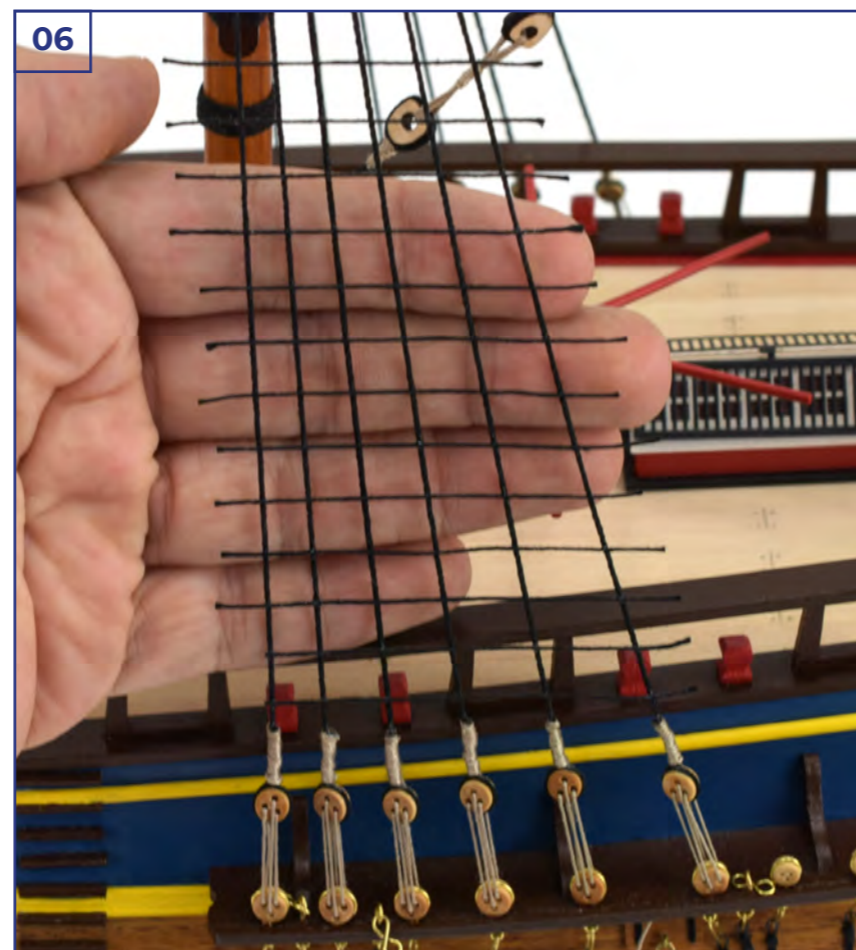
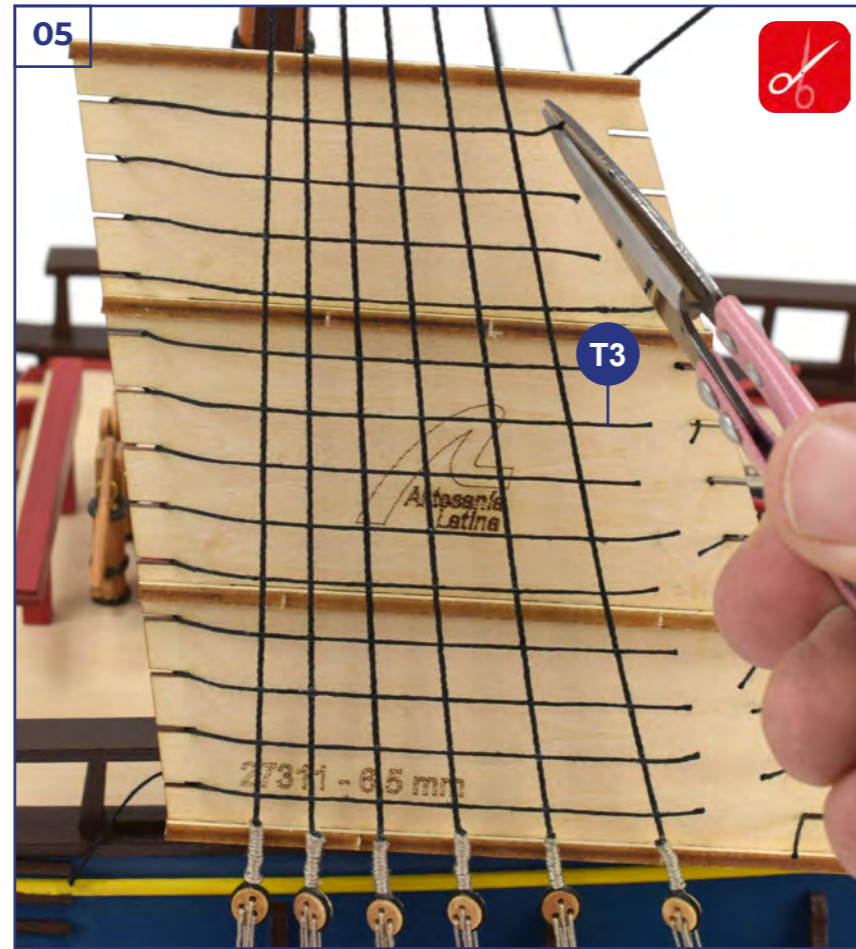

08

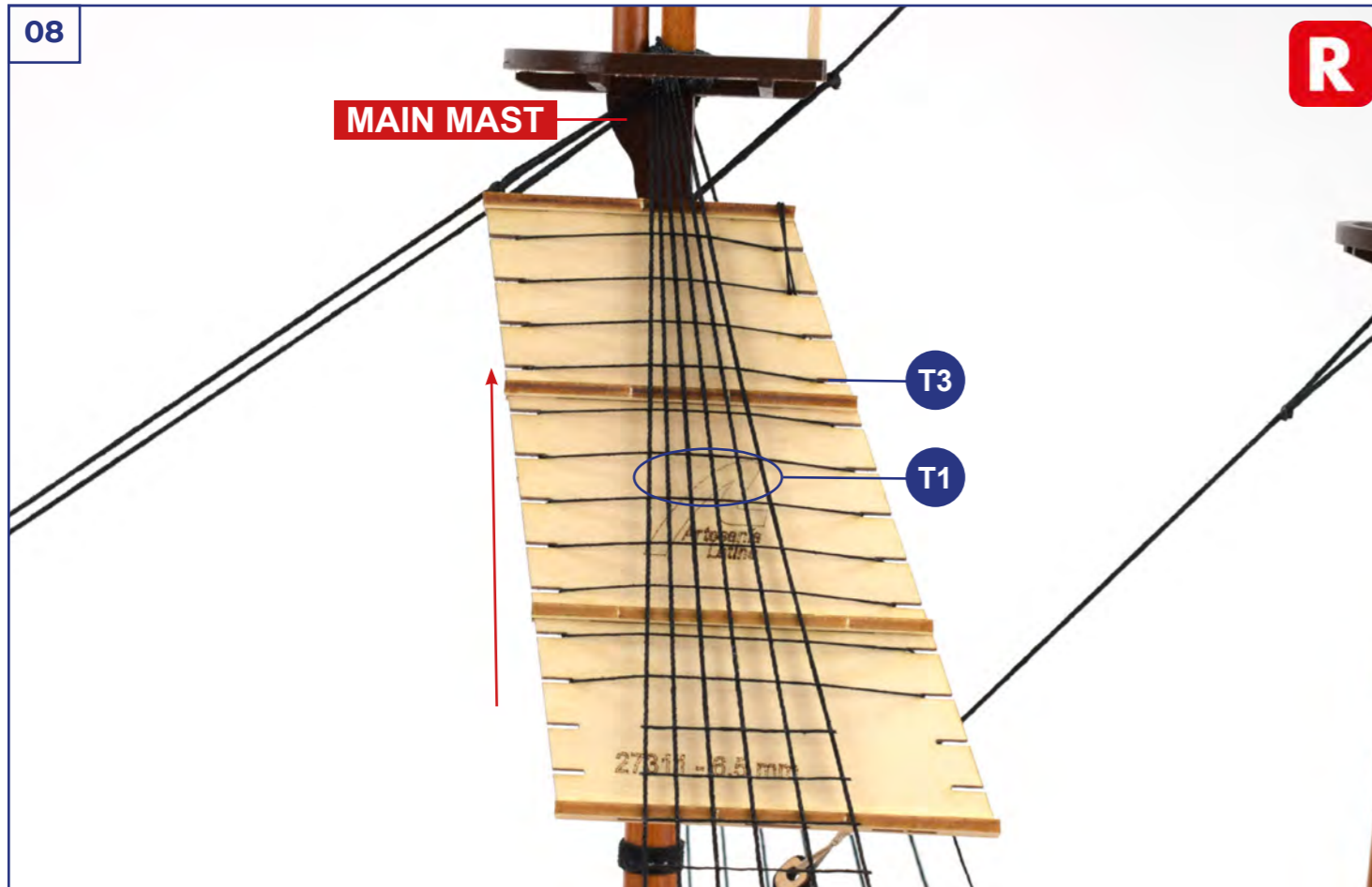

09

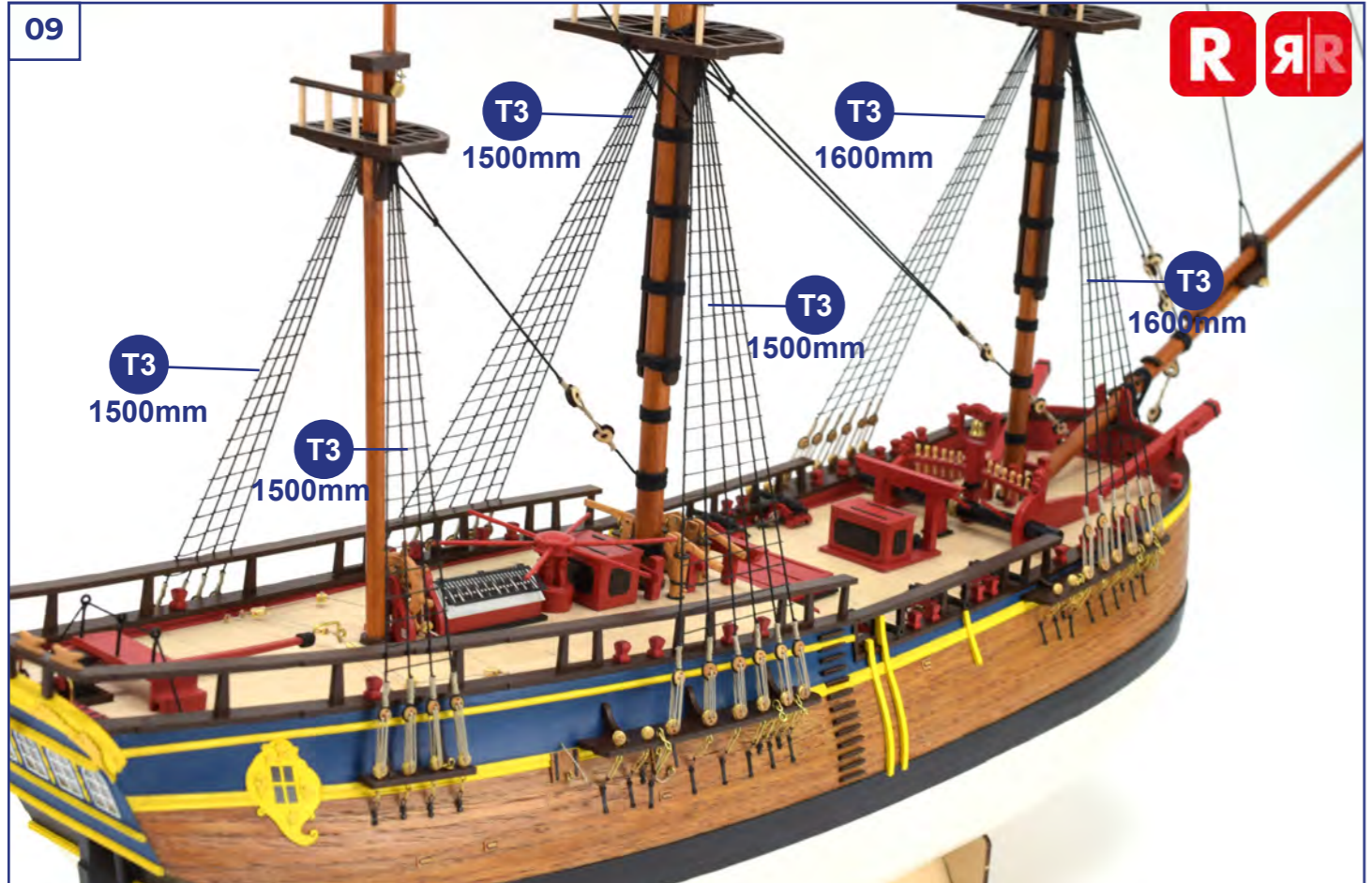

10



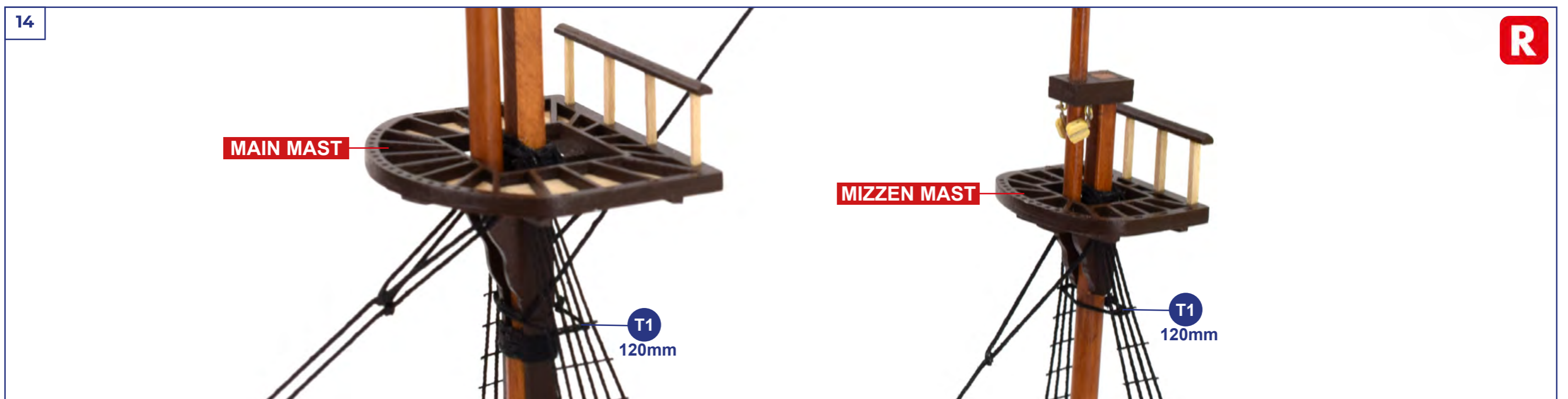
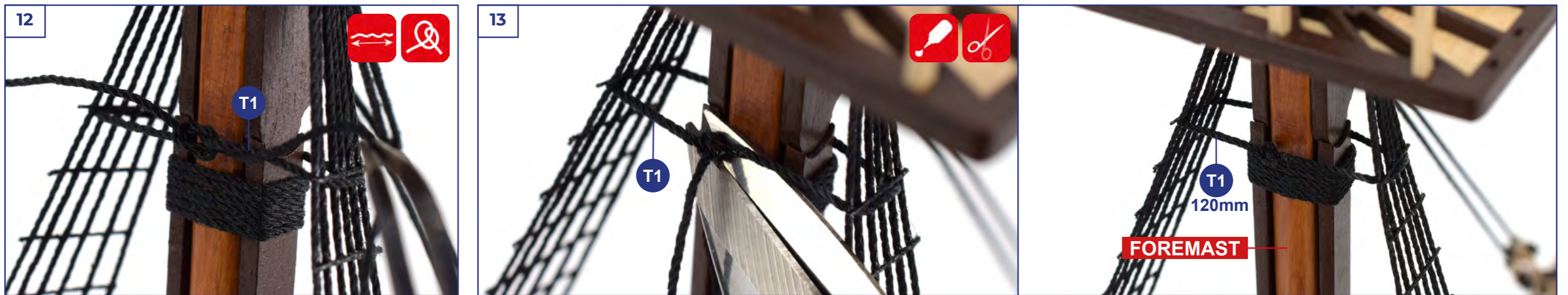
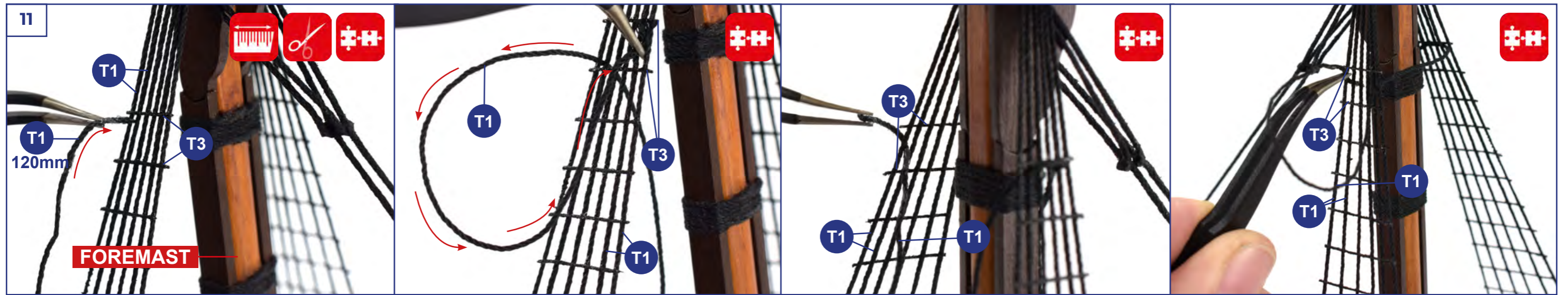

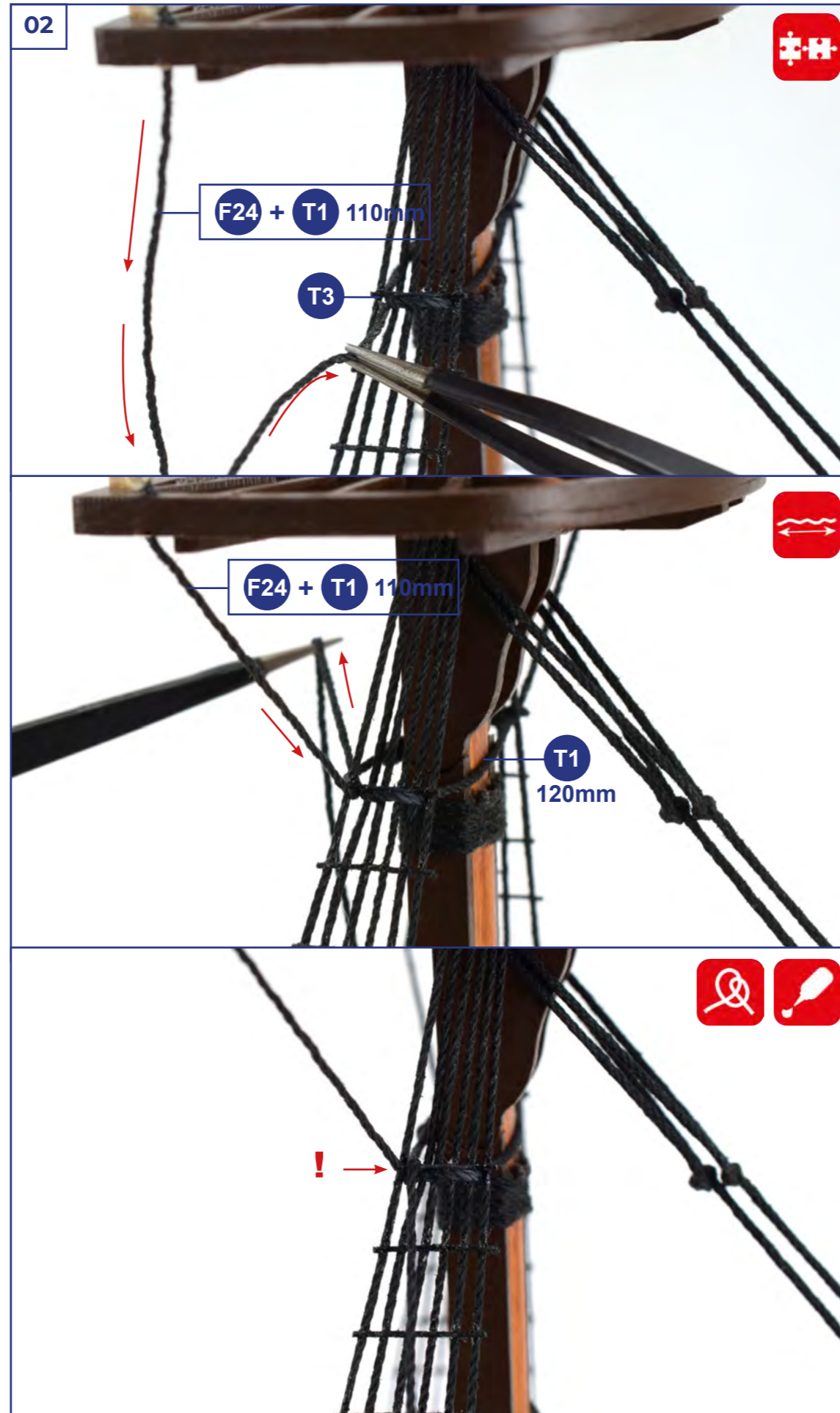
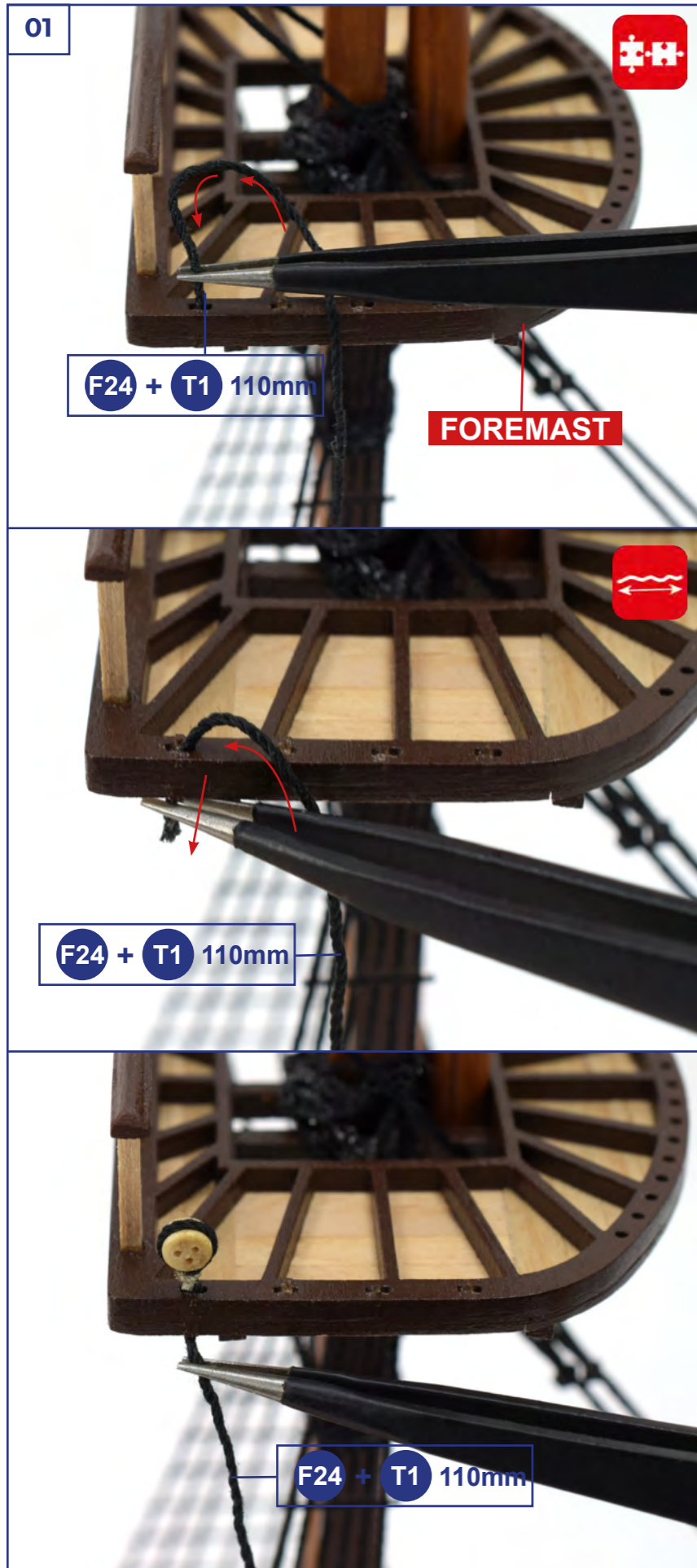

04

FOREMAST

R
x8

F24 + T1 110mm

F24 + T1 110mm

R

MAIN MAST

MIZZEN MAST

F24 + T1 110mm
x8

F24 + T1 110mm
x6

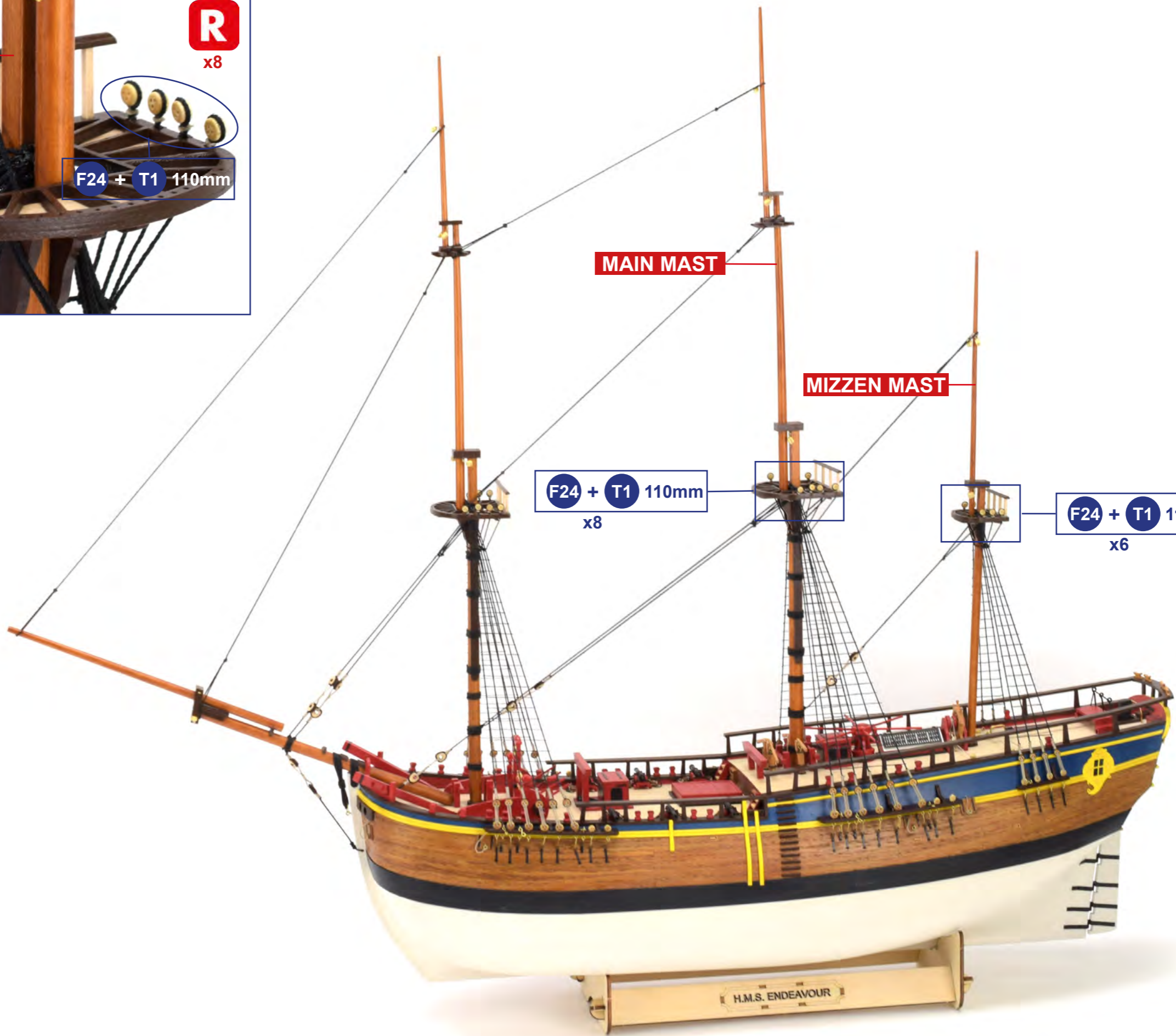

H.M.S. ENDEAVOUR

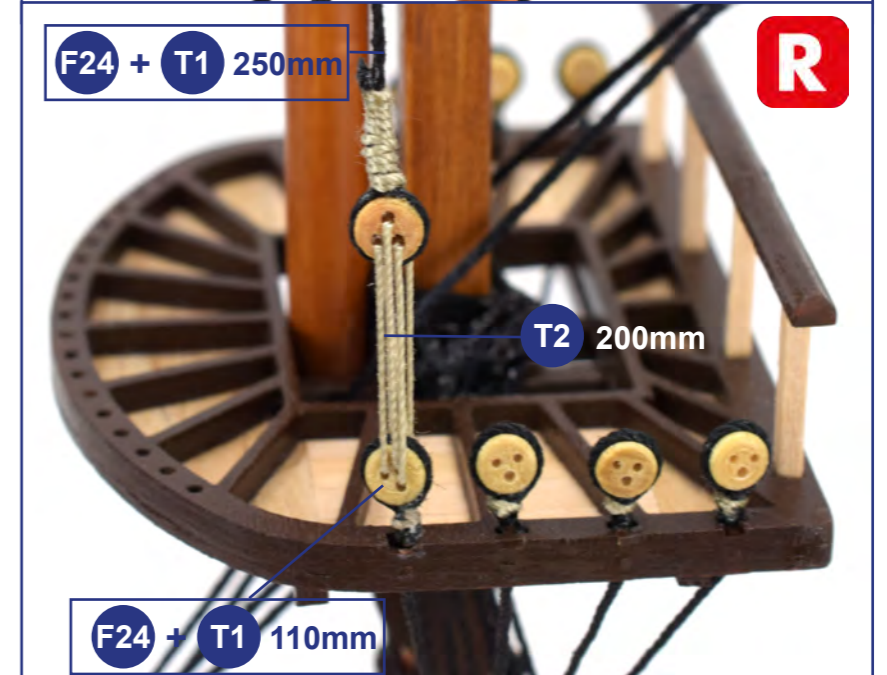
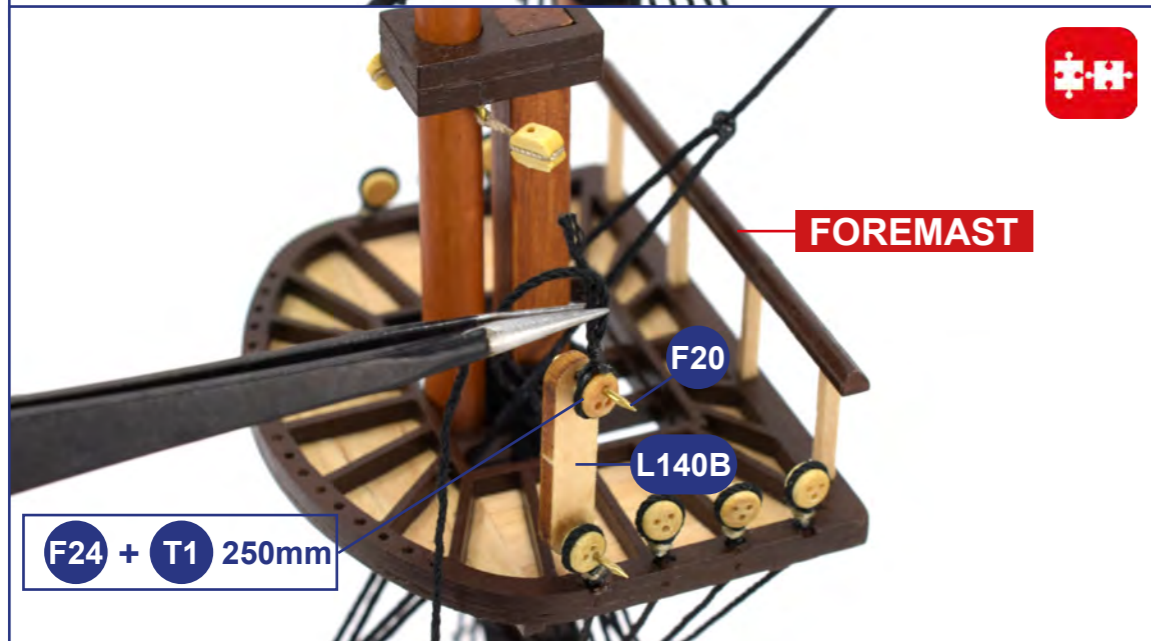
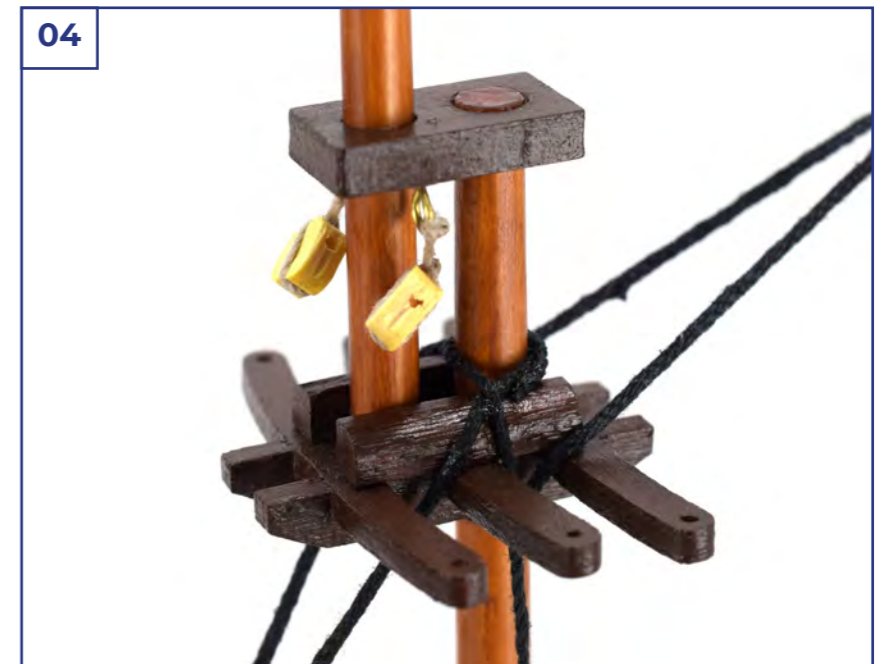
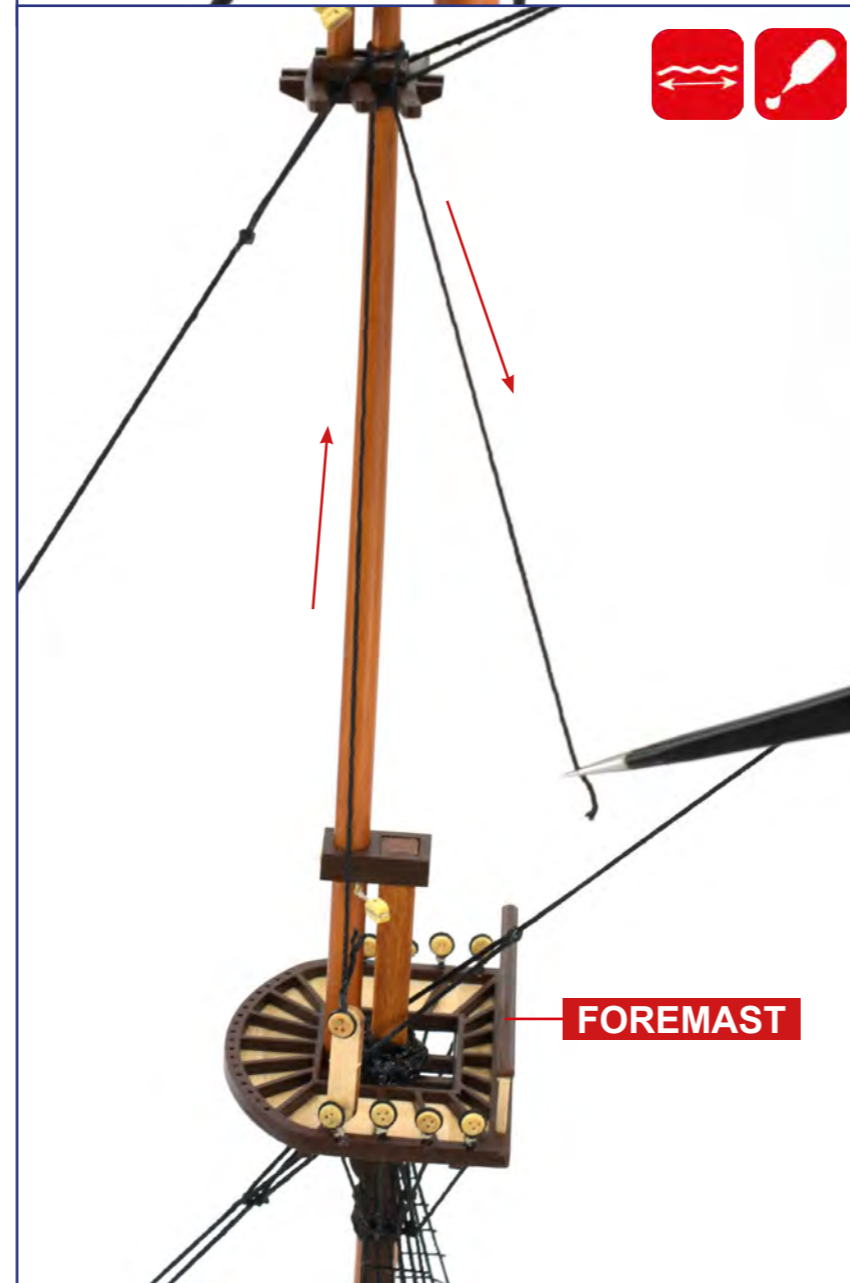
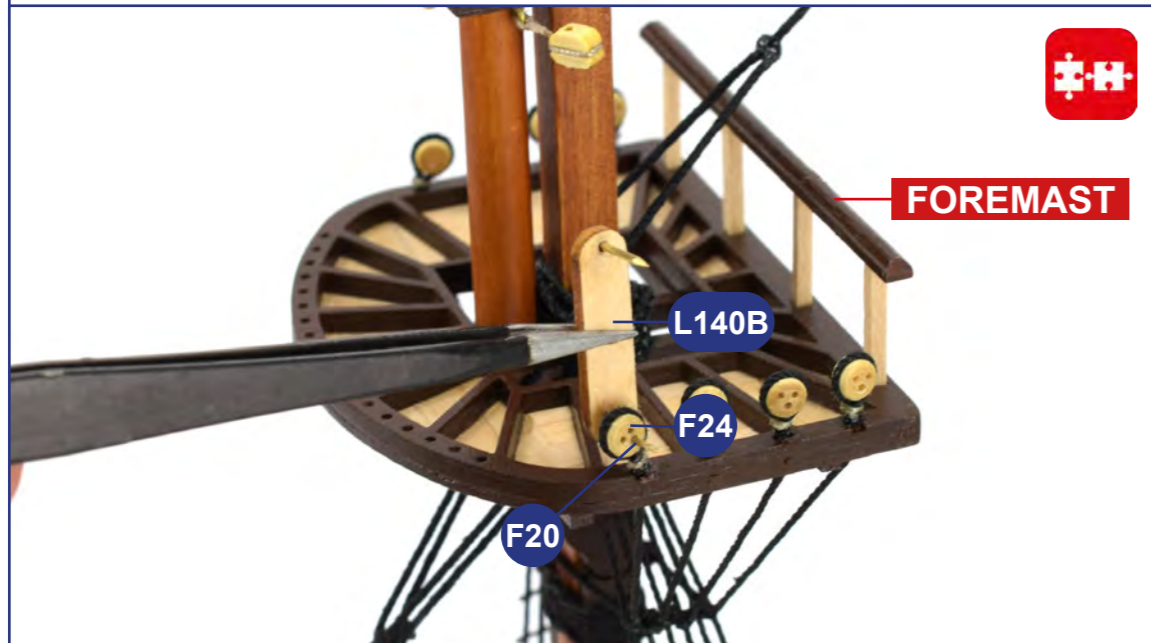
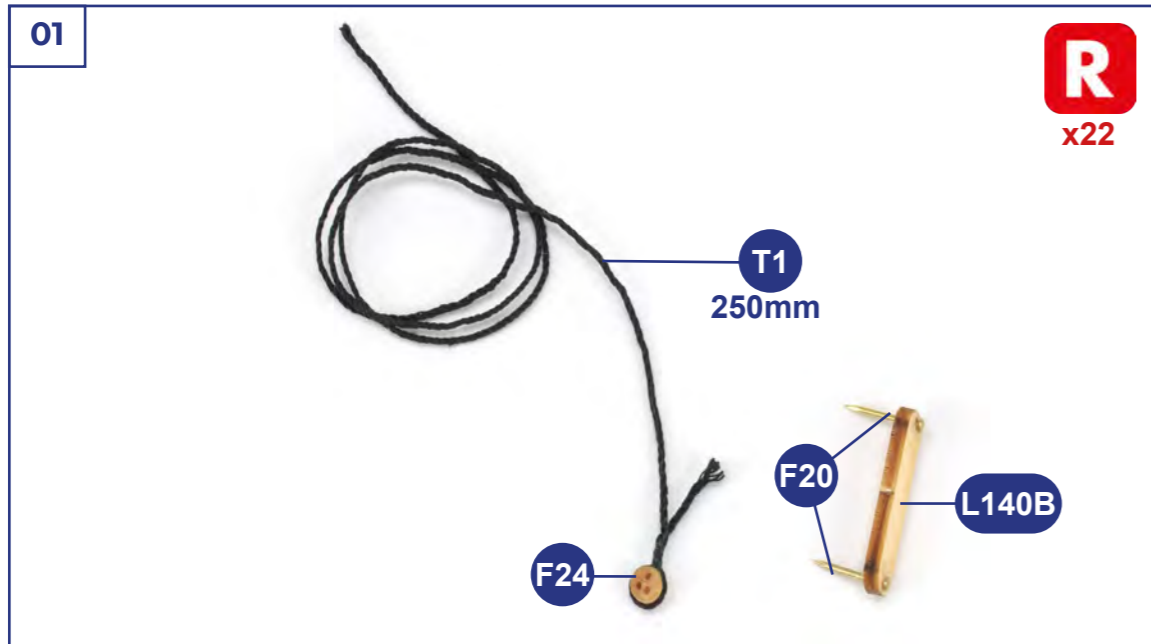

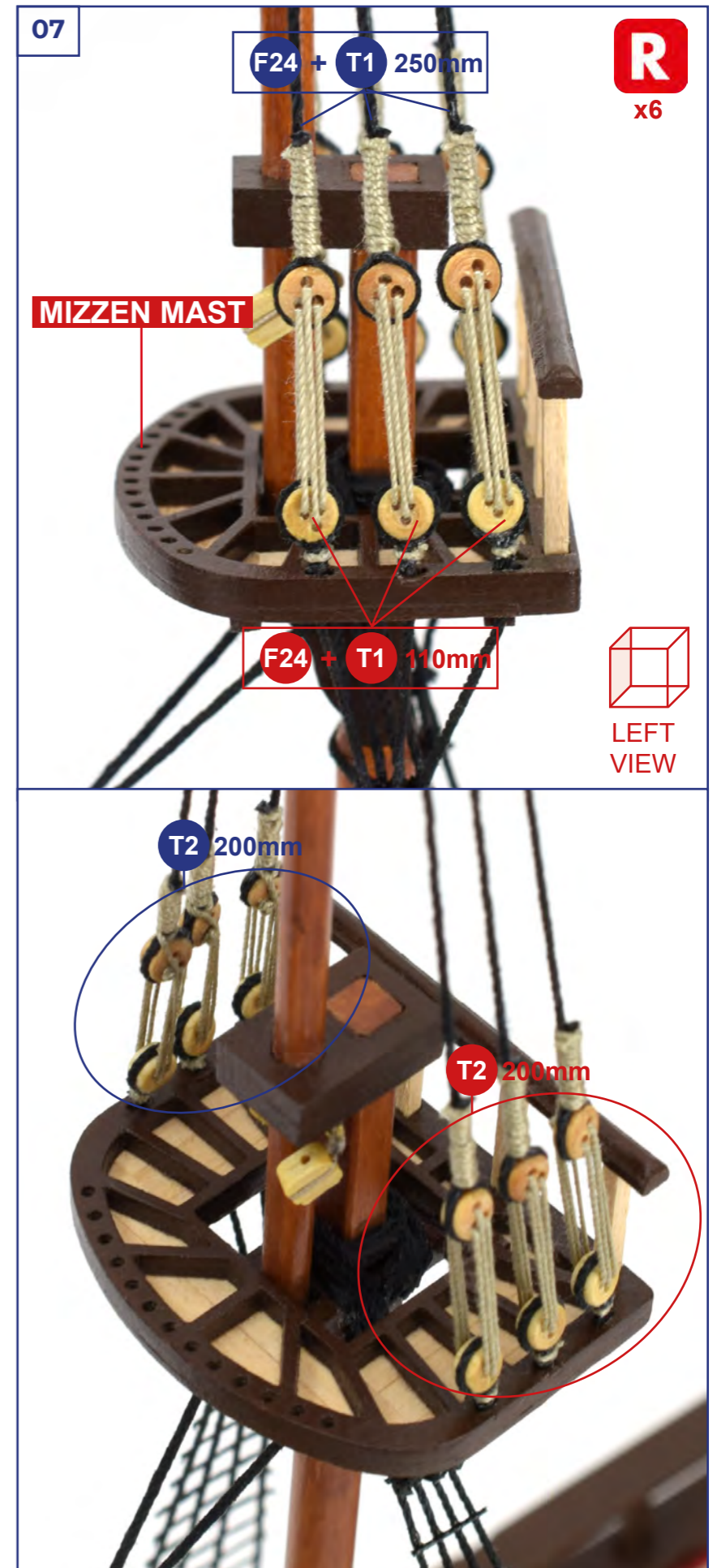
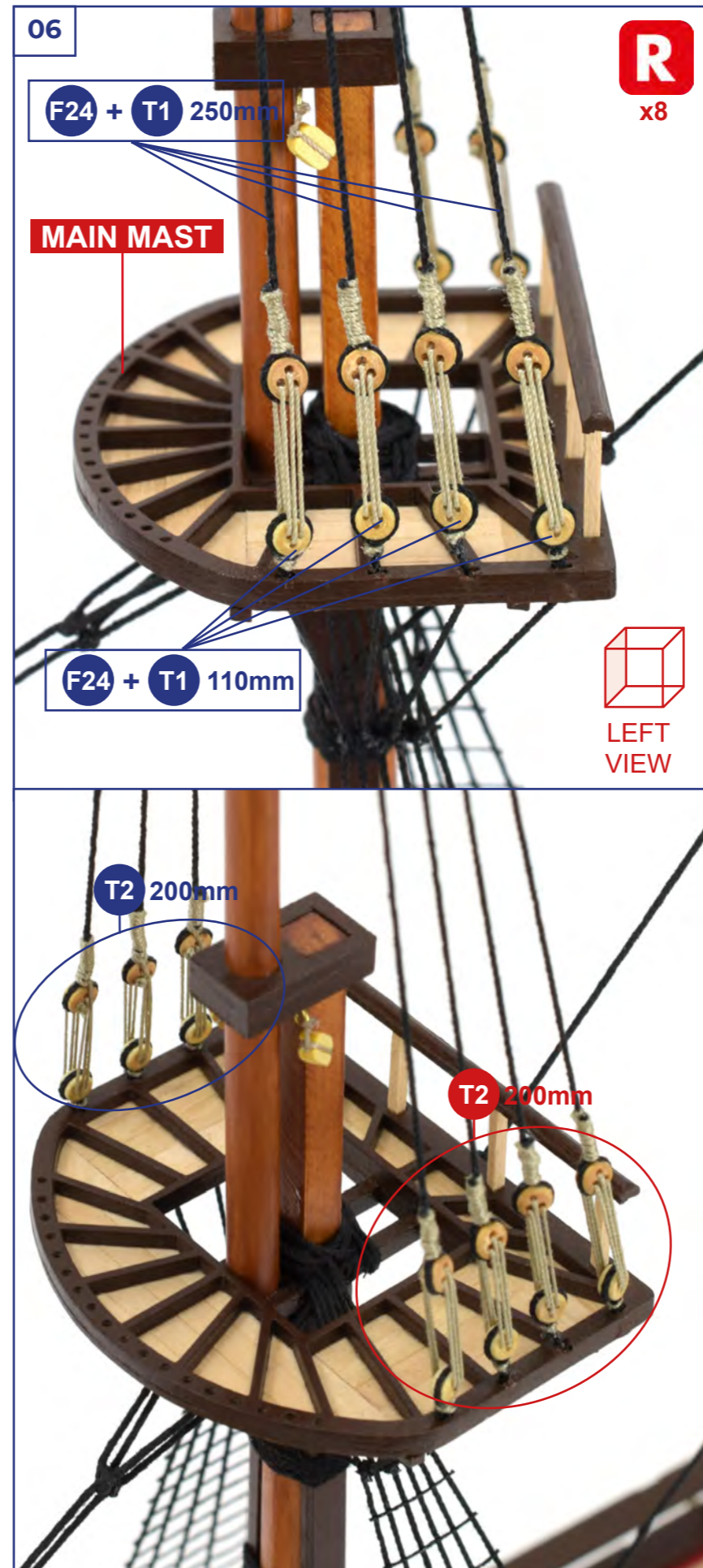
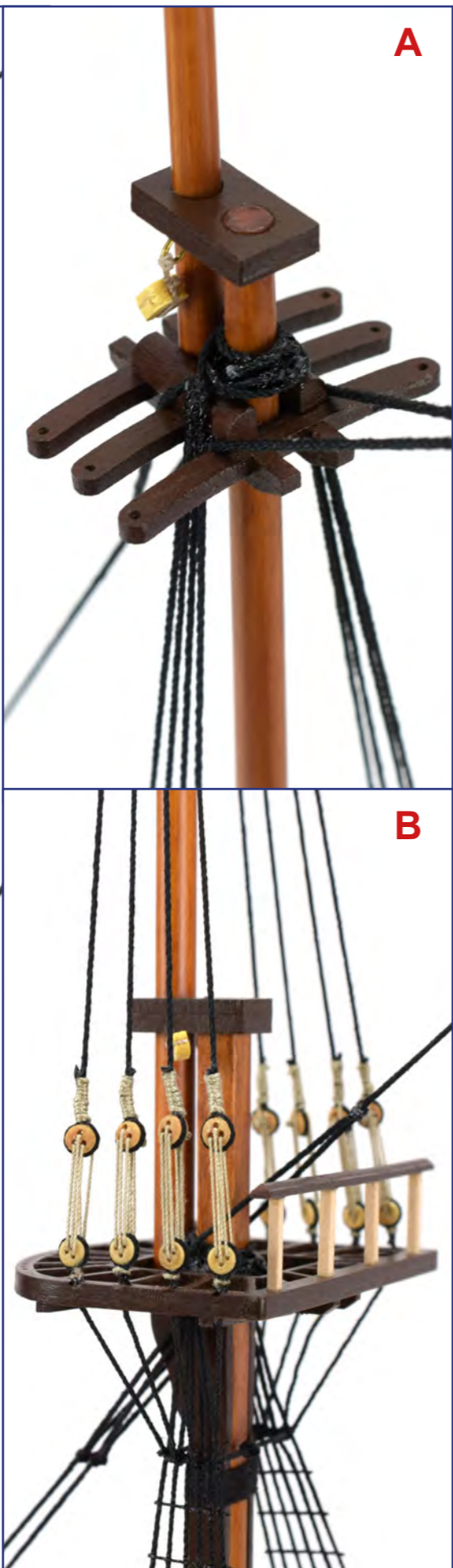
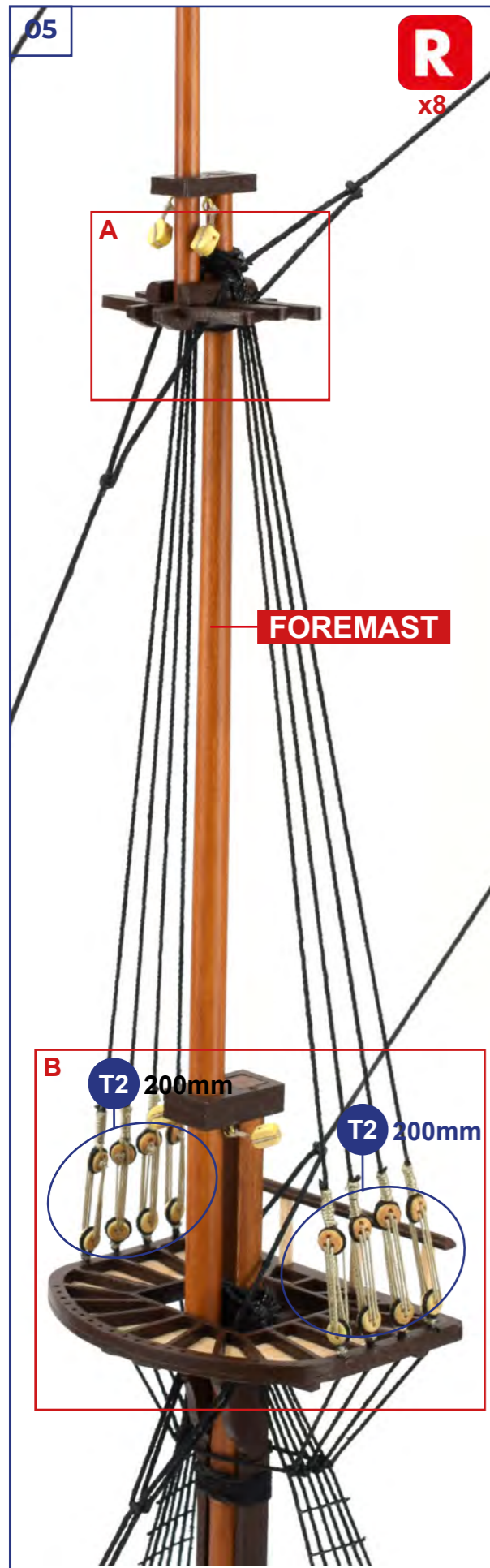

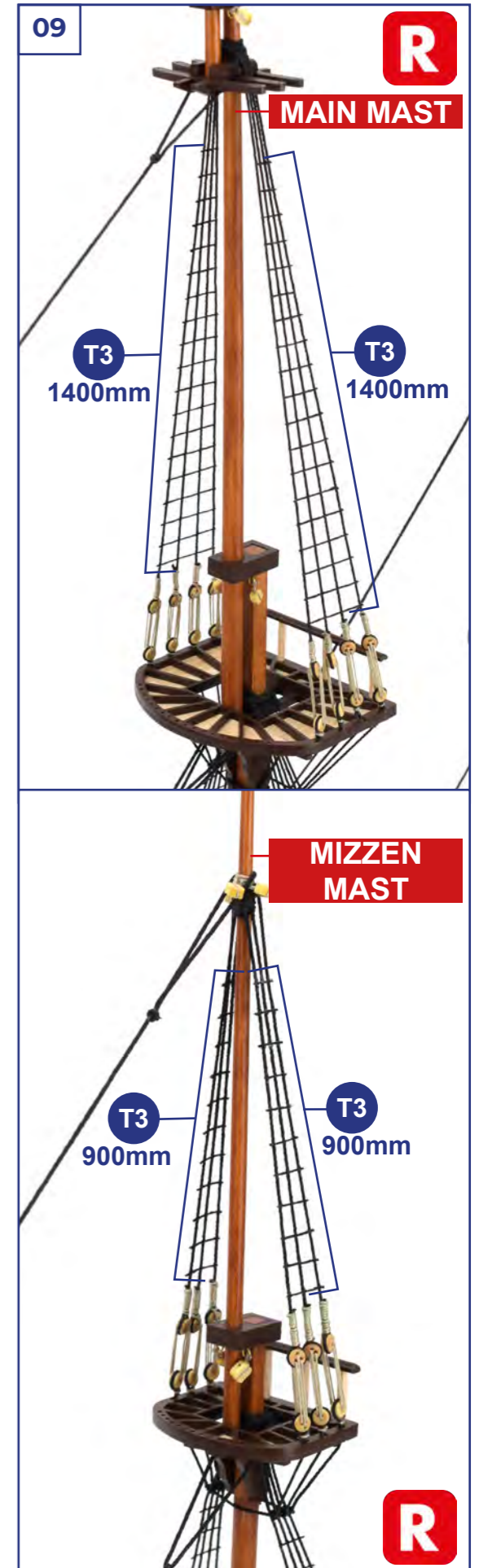
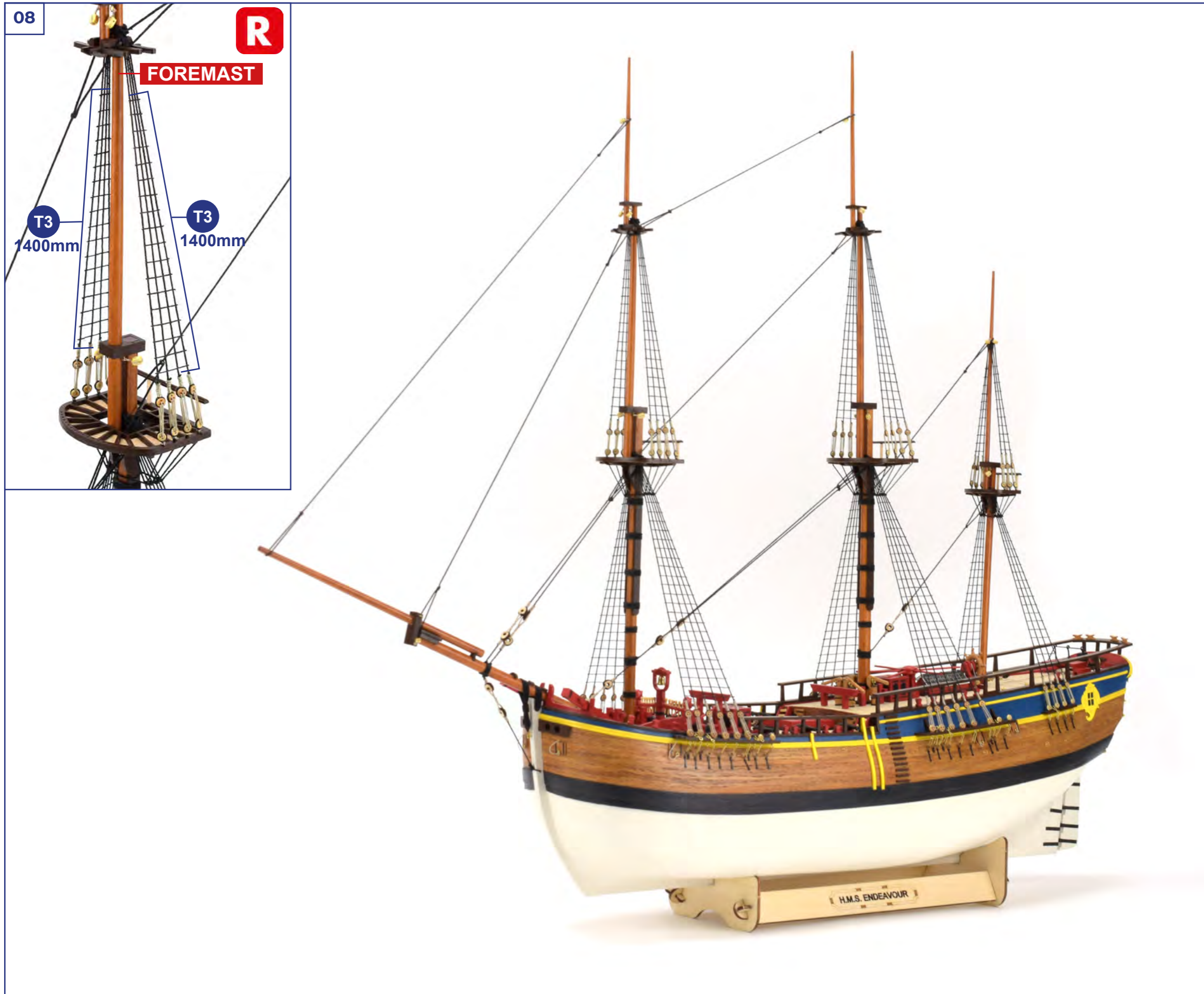

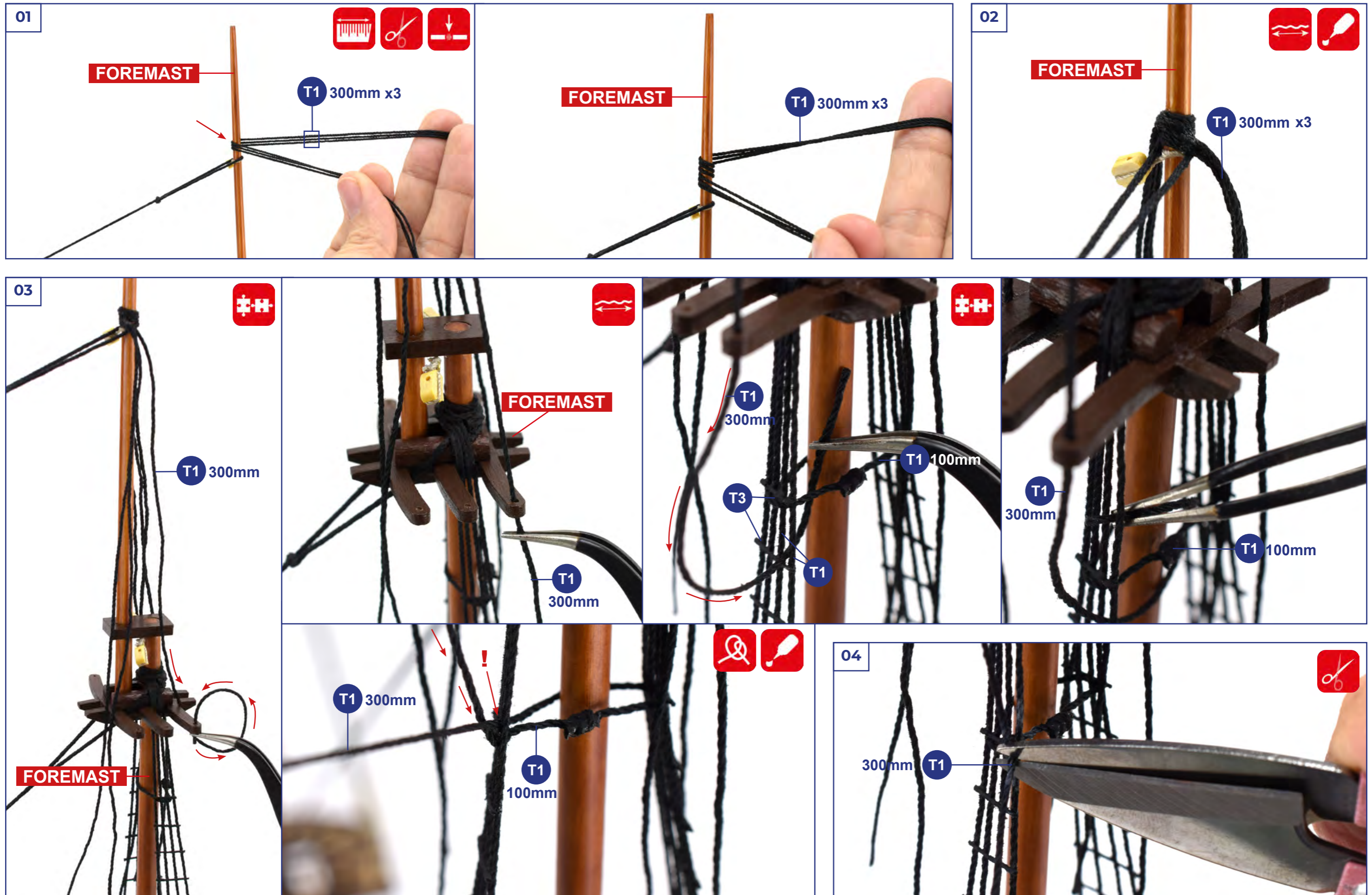

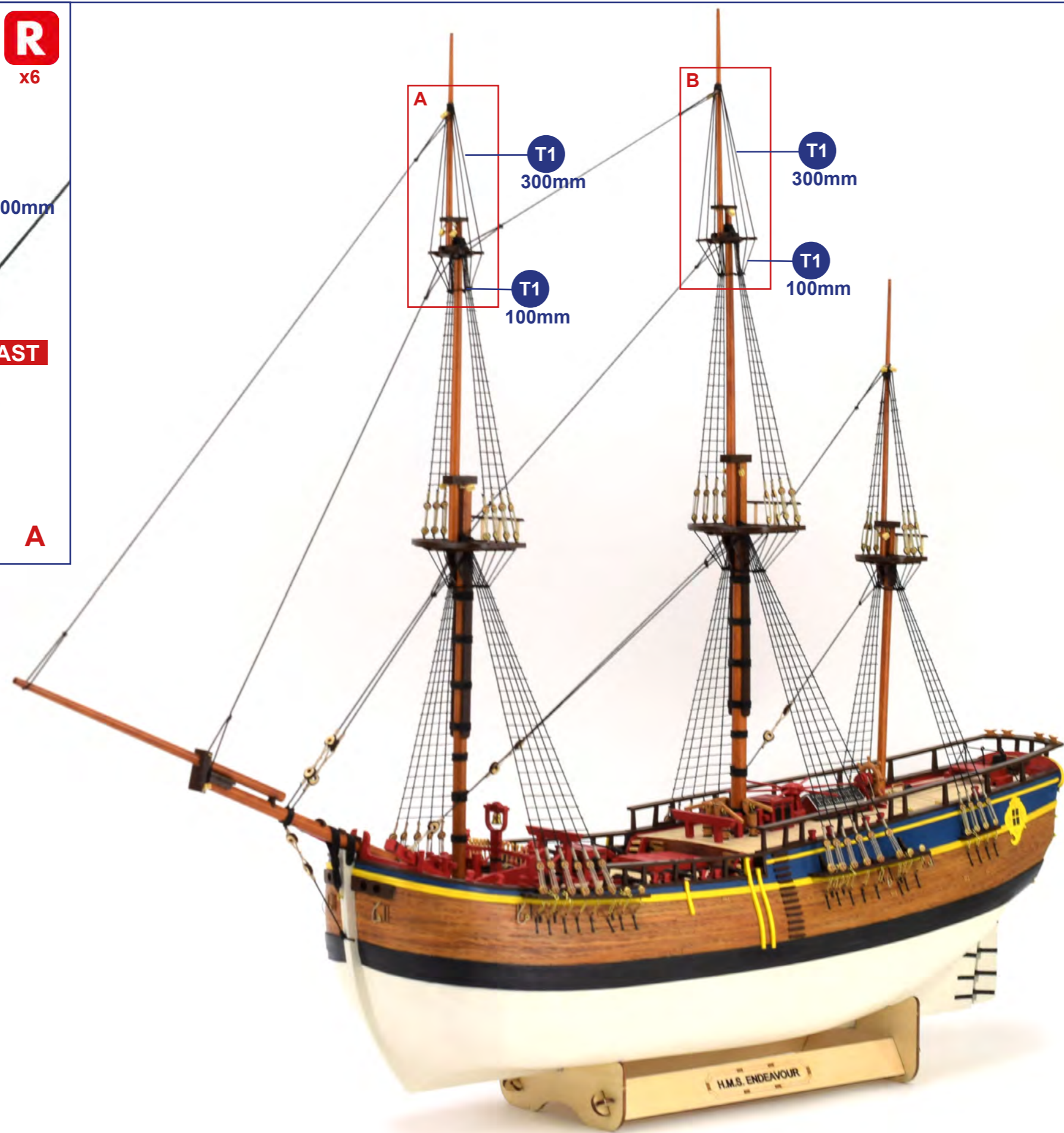

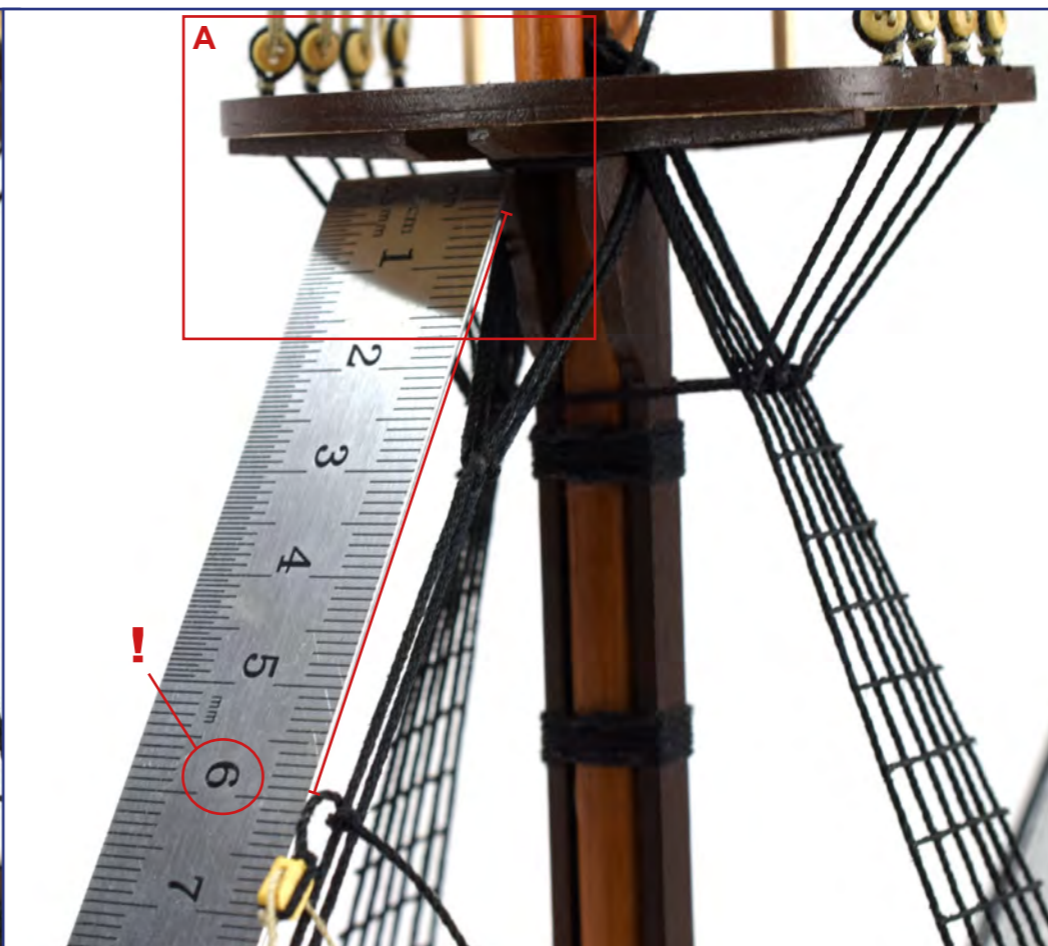
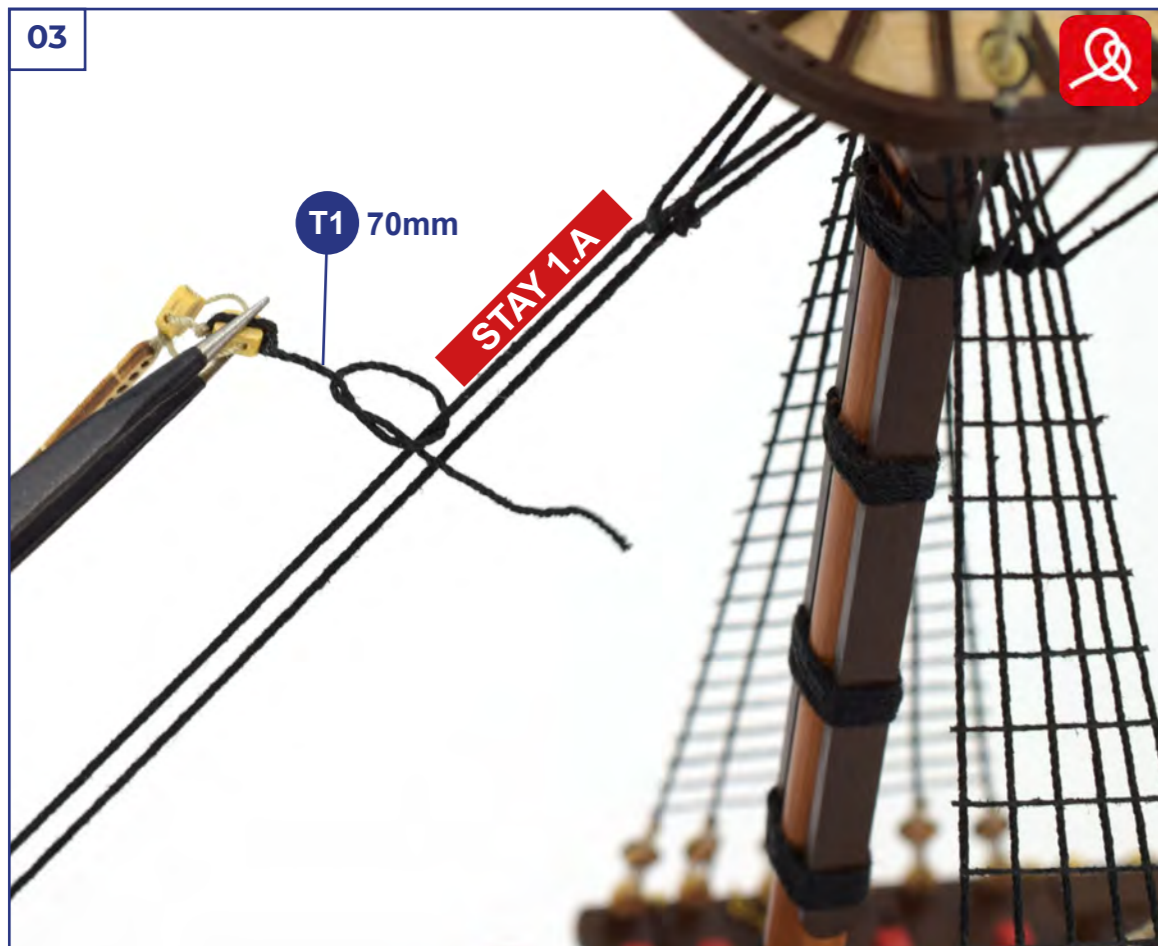
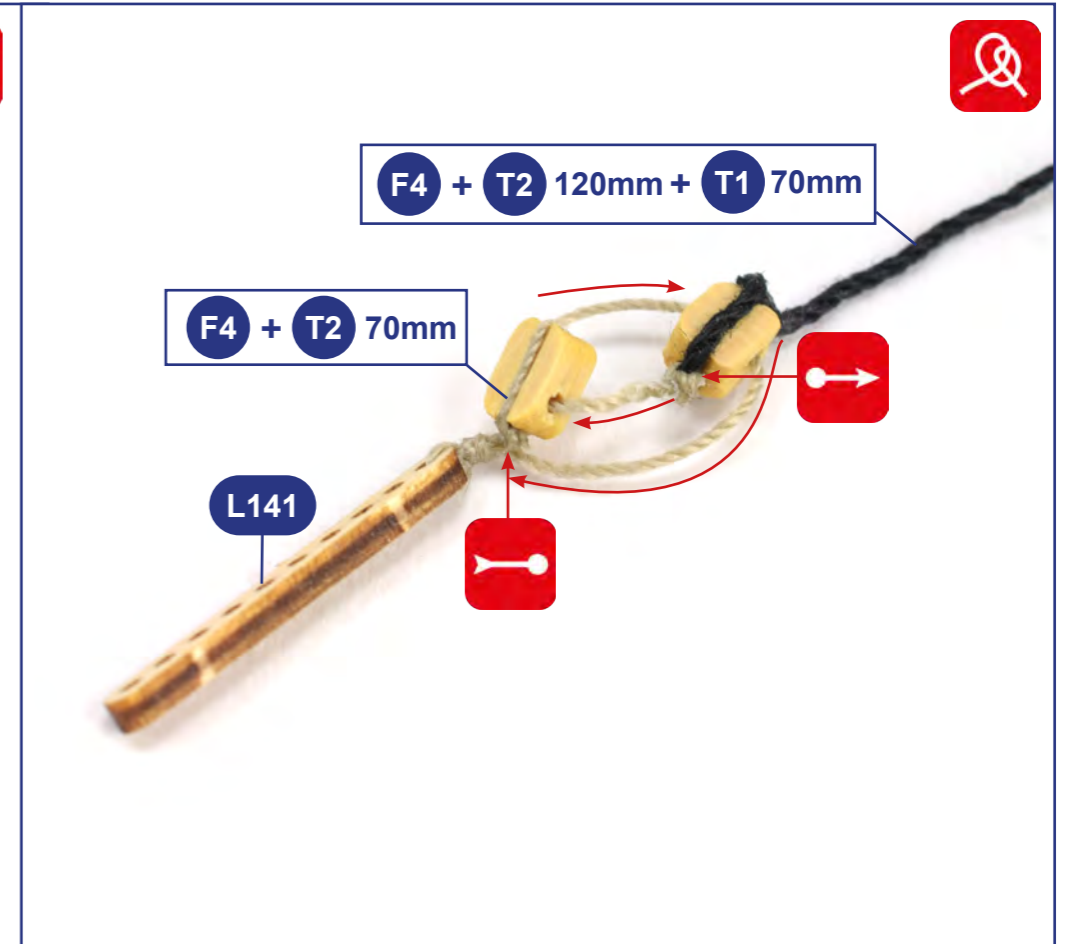
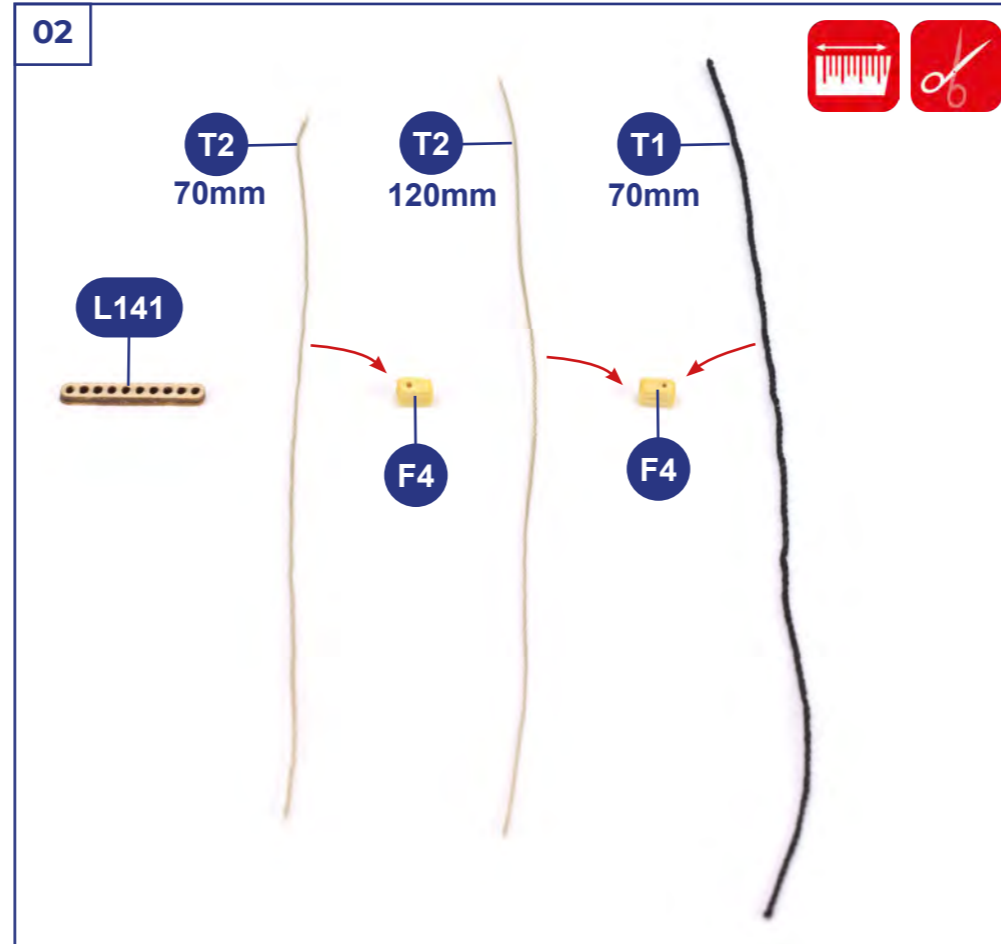
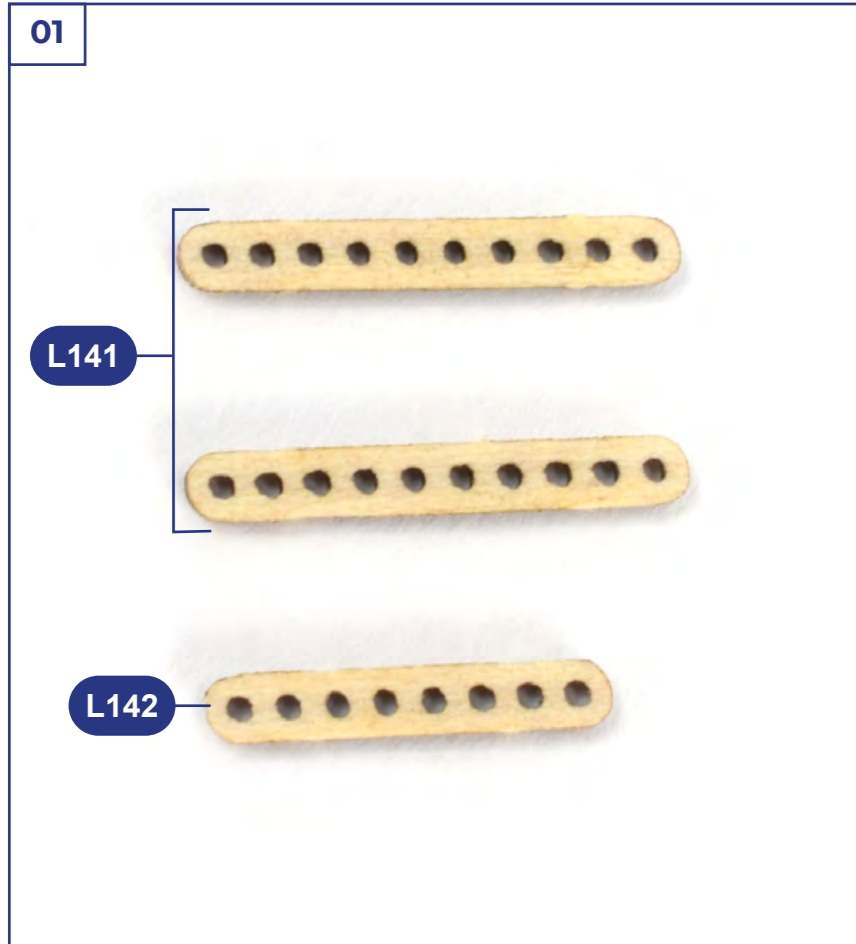

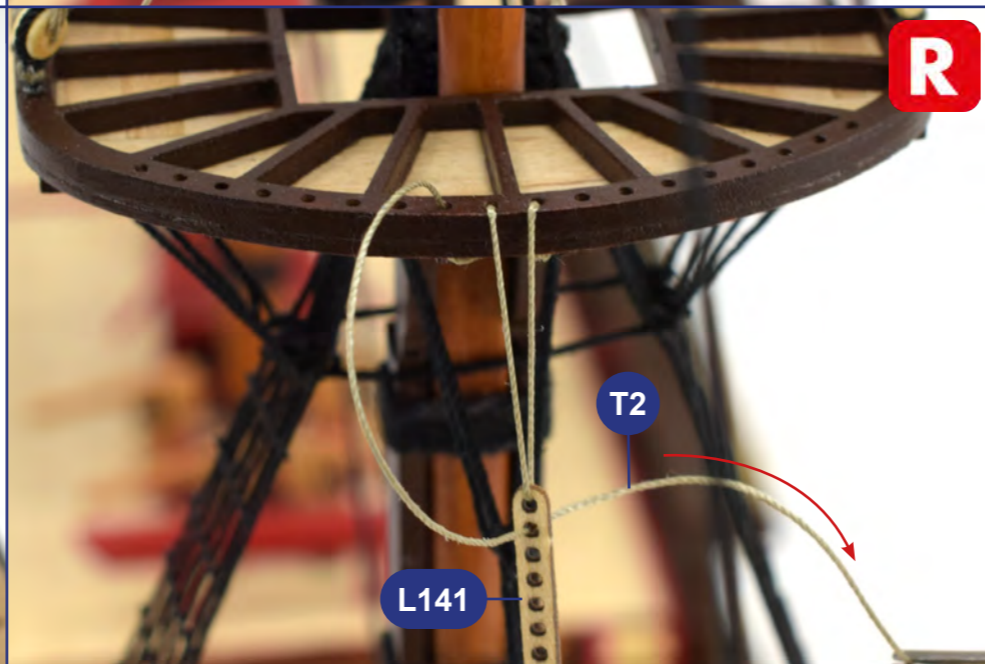
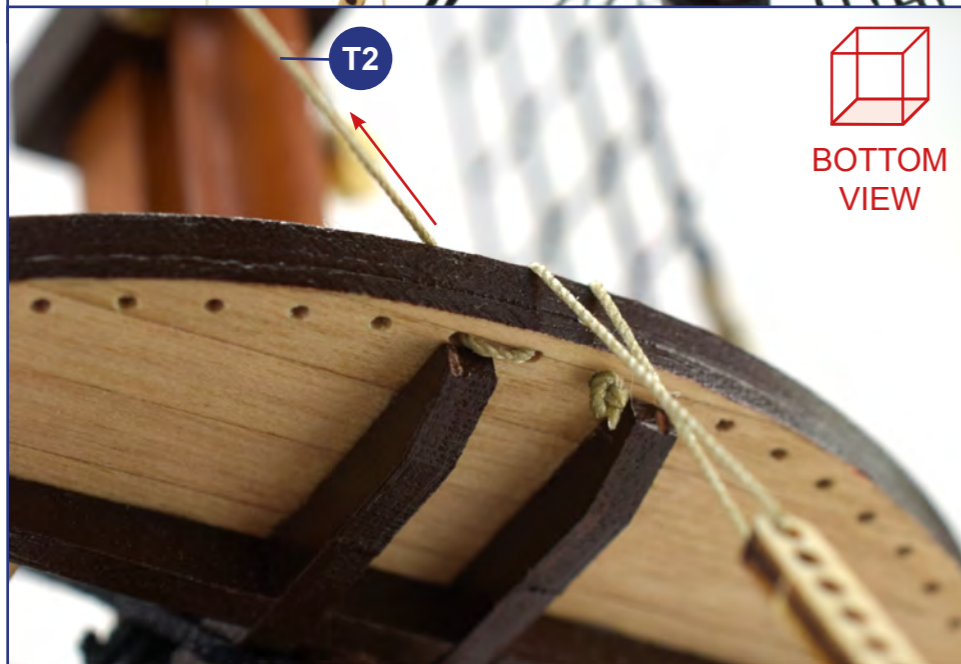
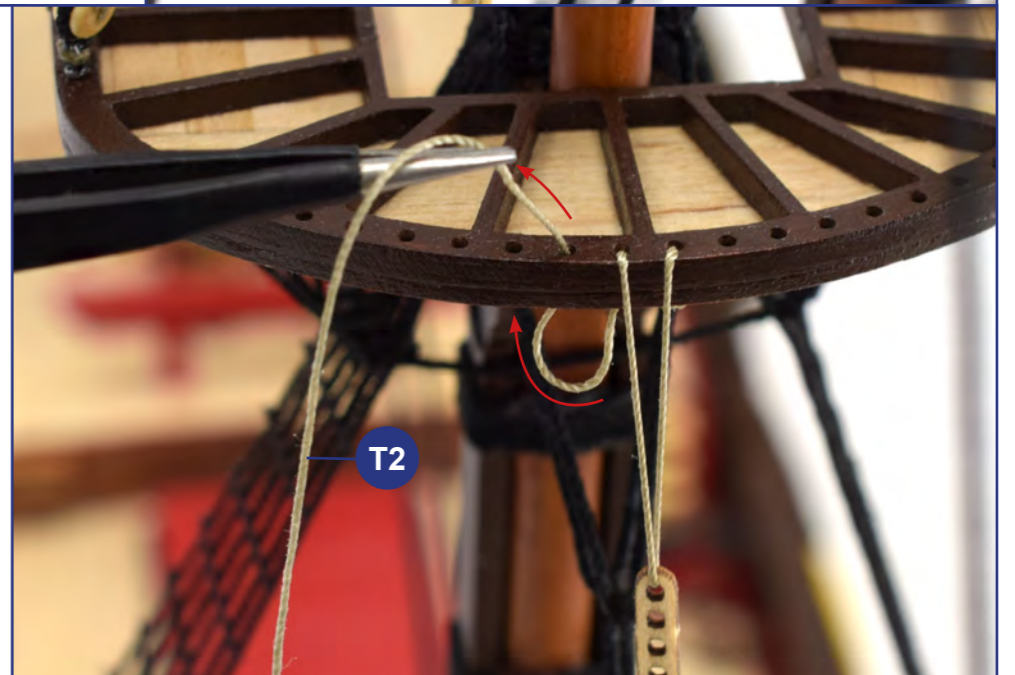
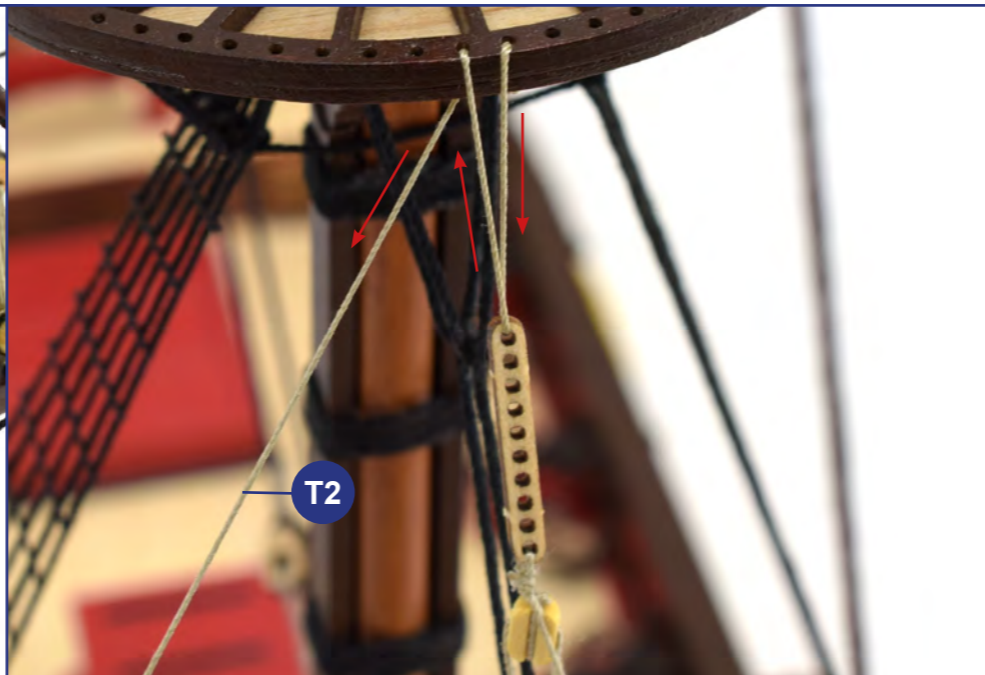
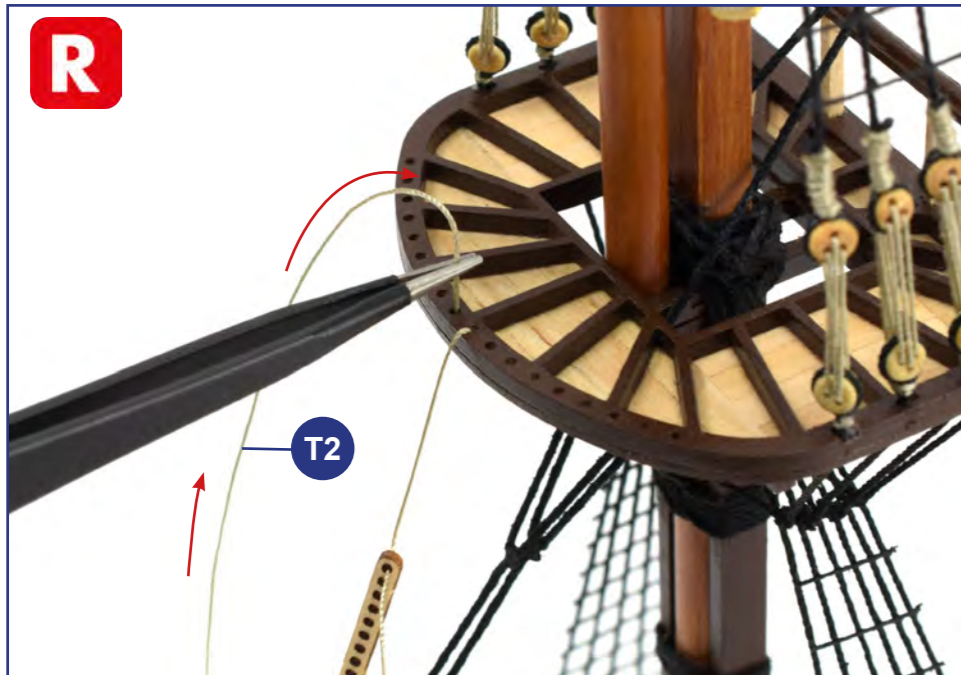
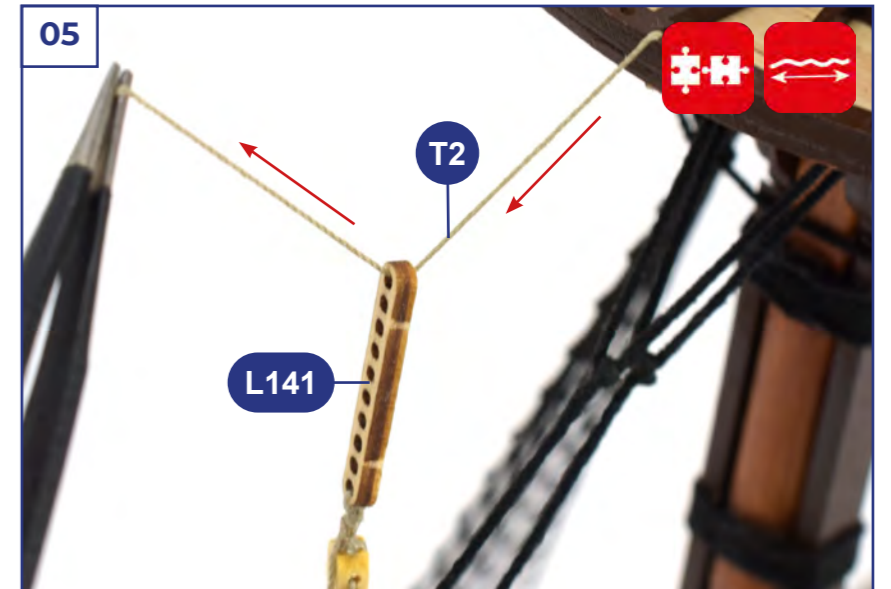
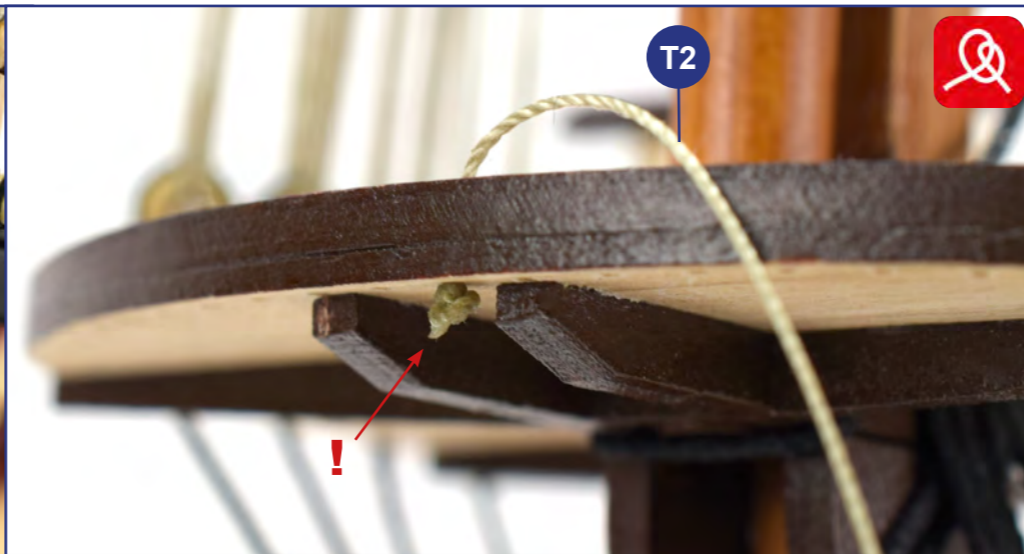
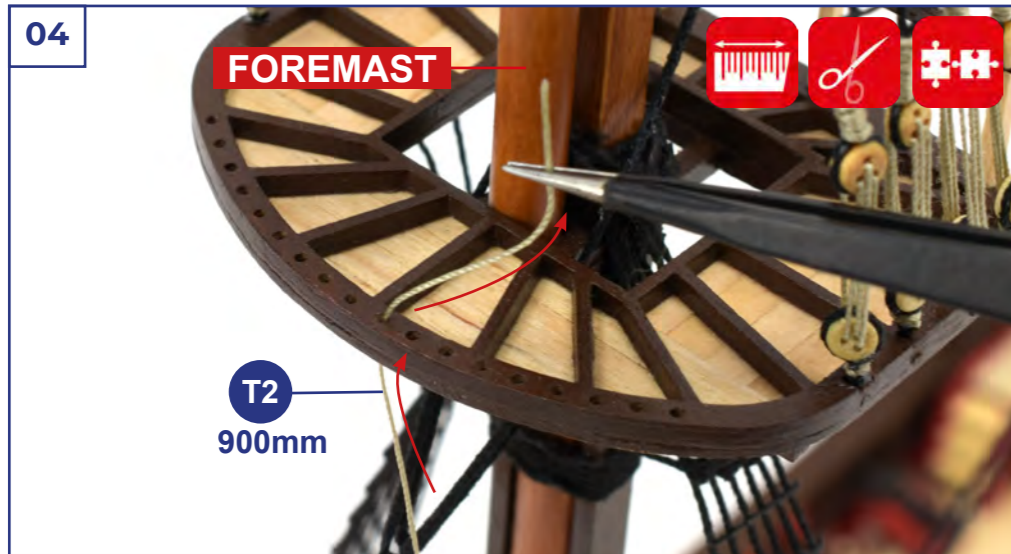

06

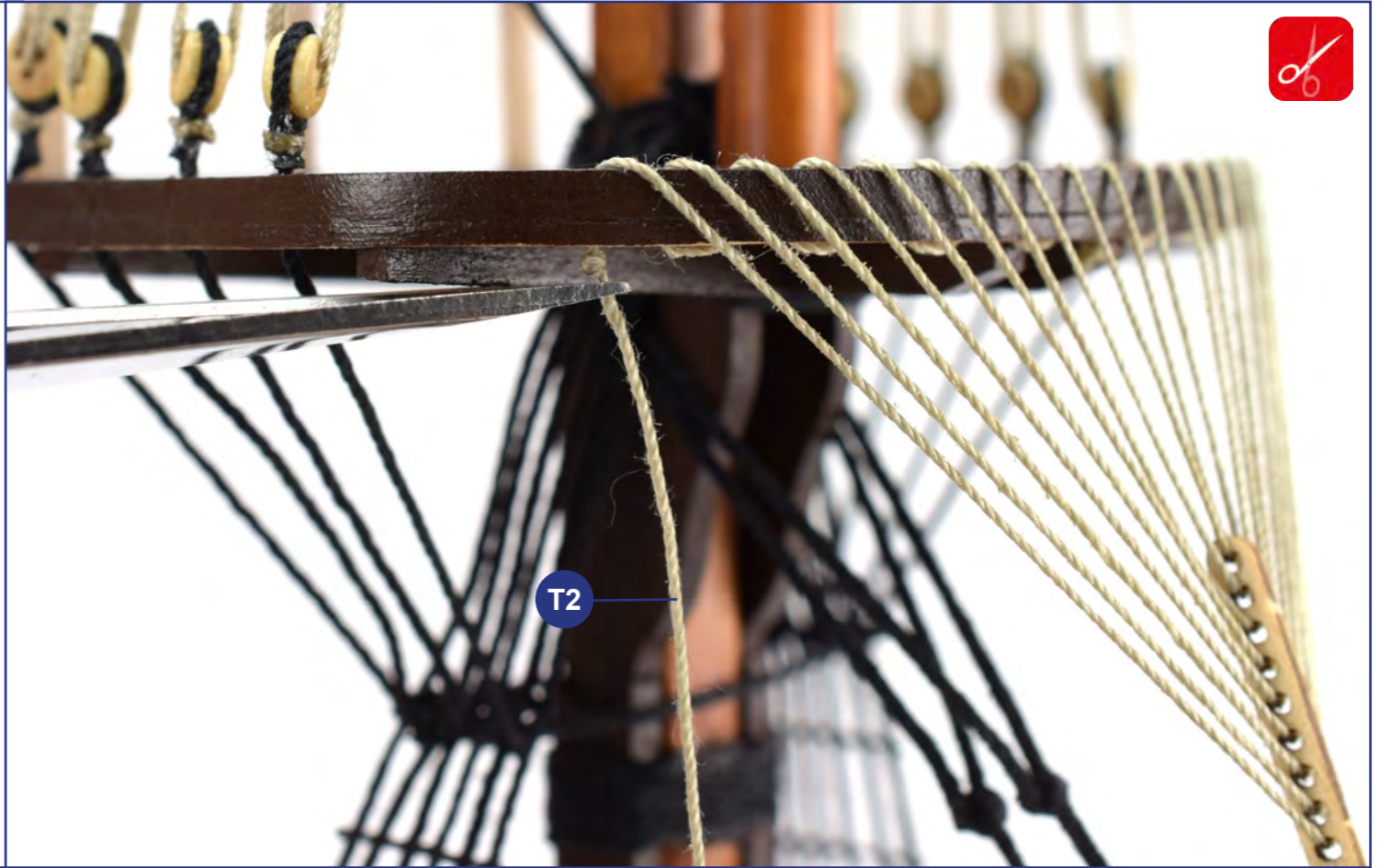
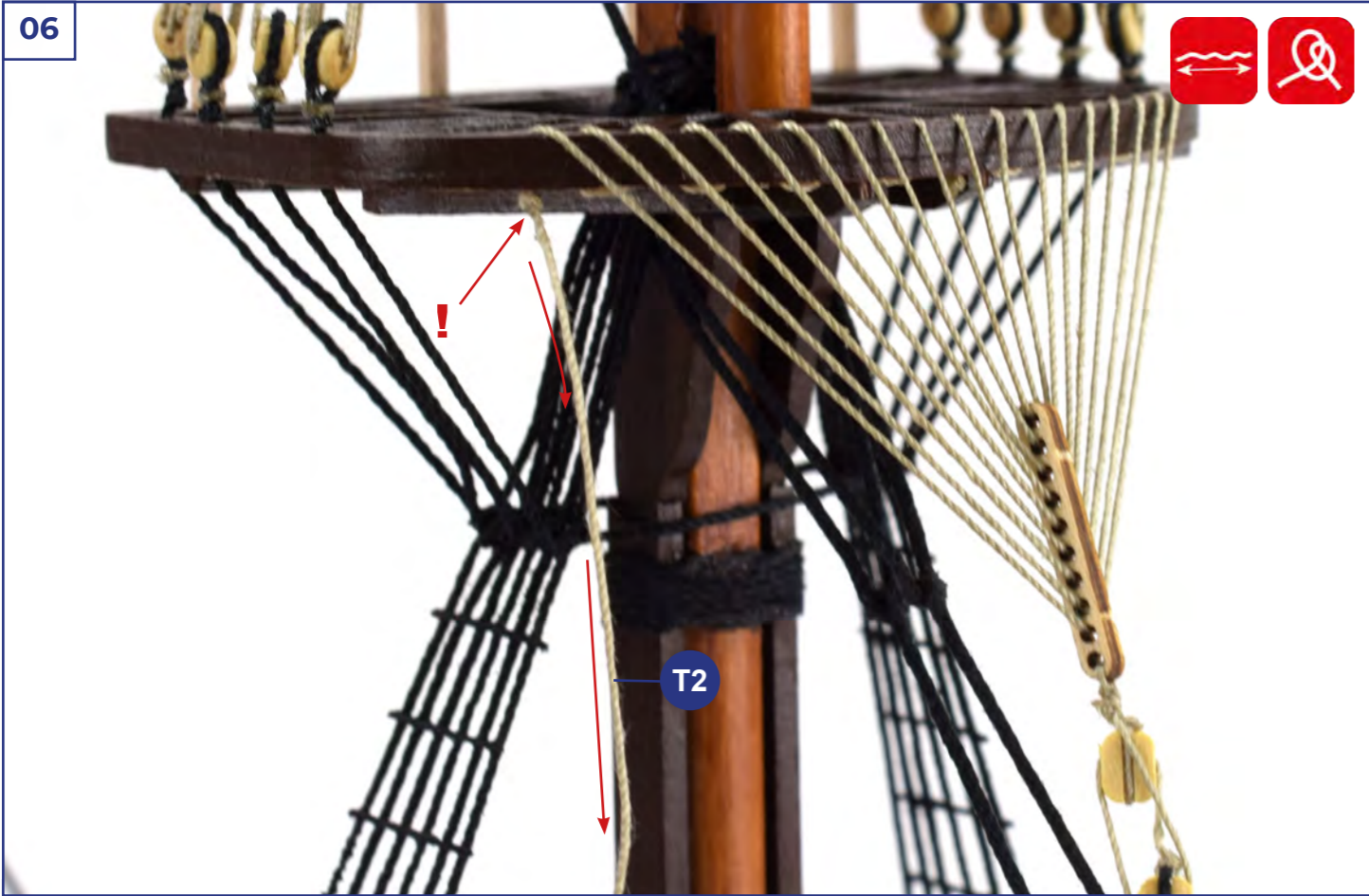

07



08

R
x3

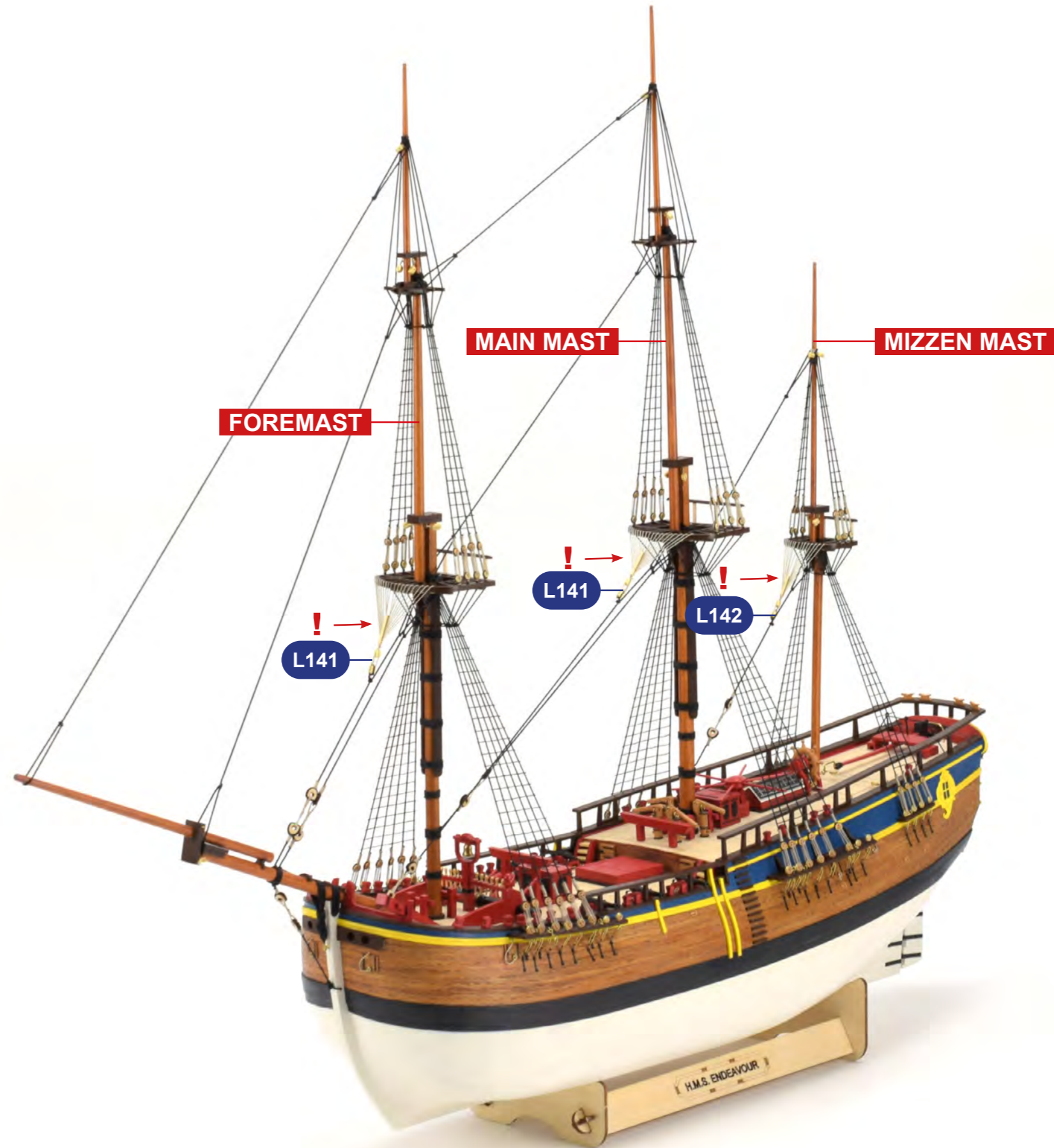

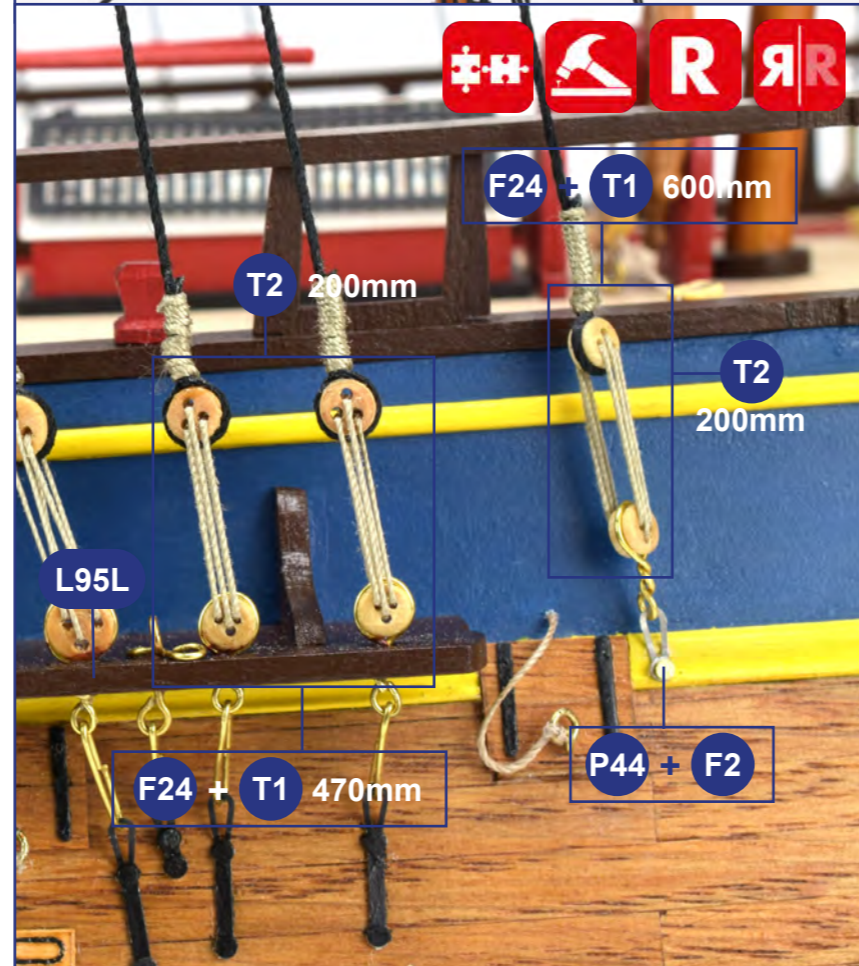
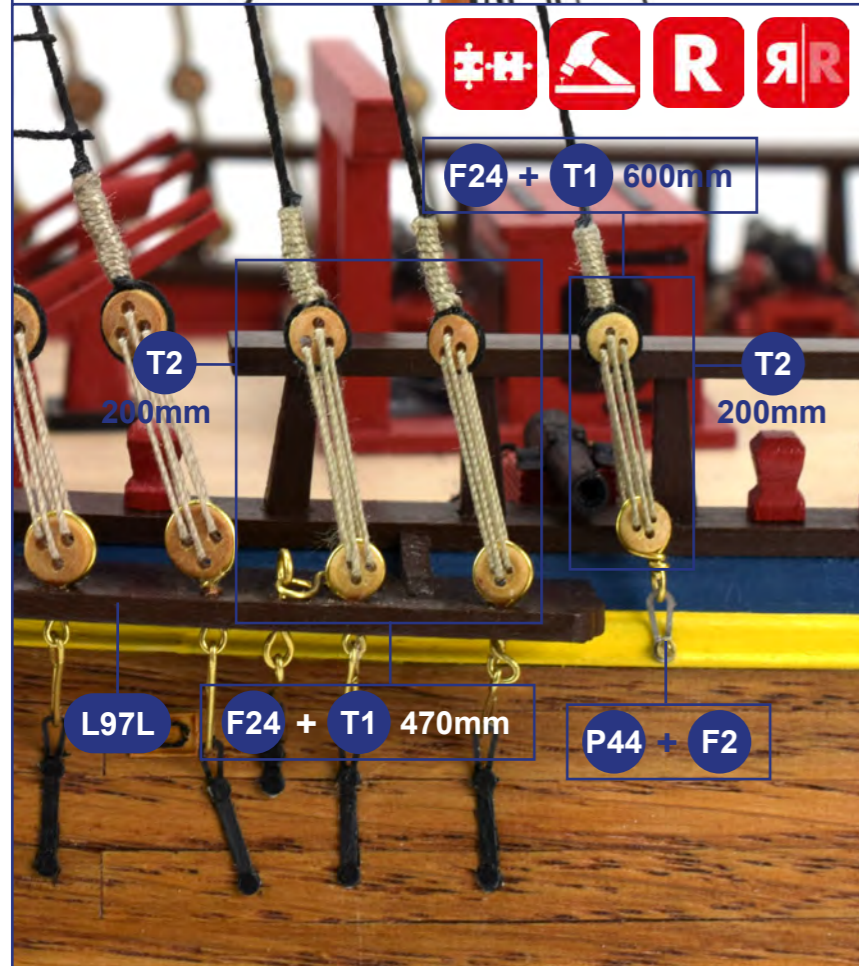
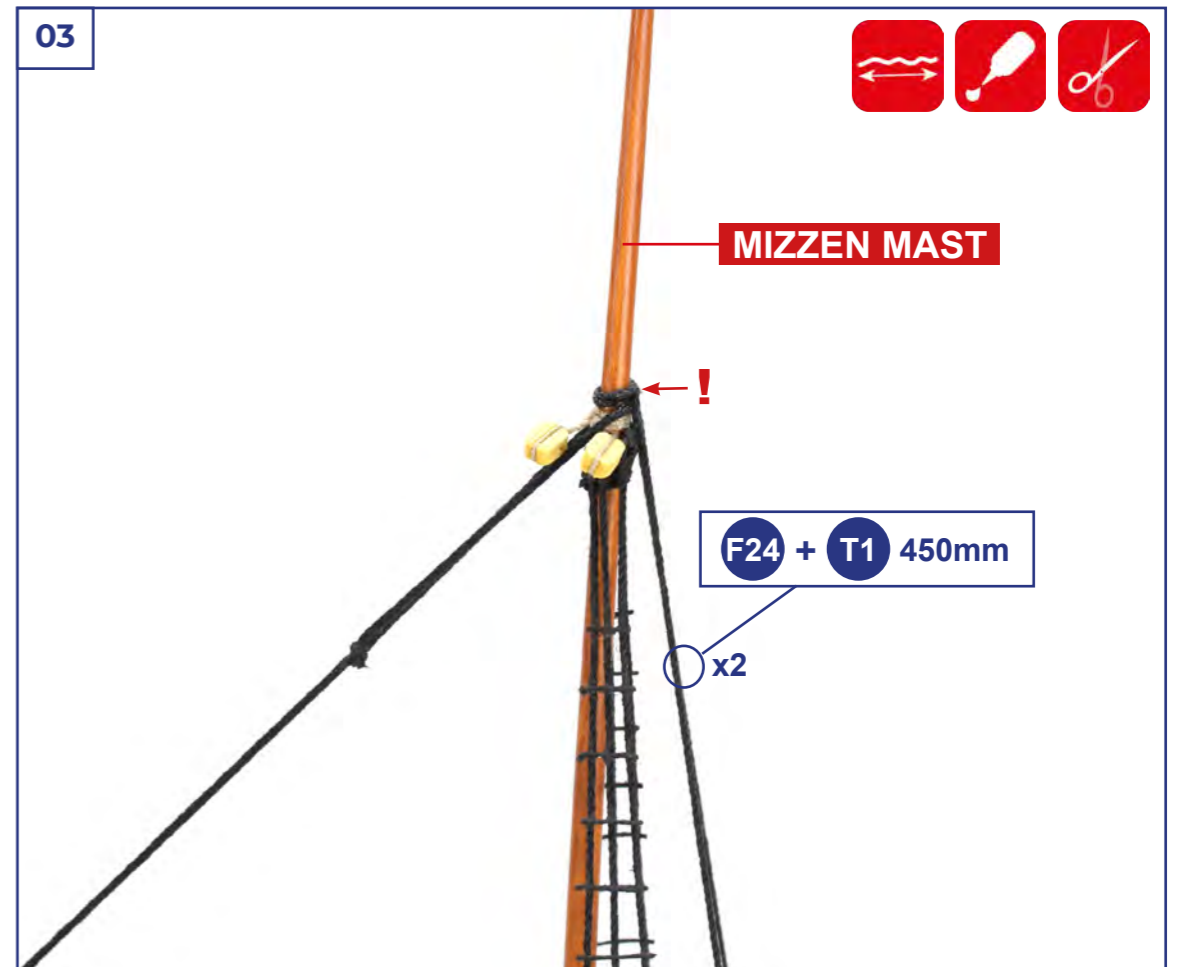
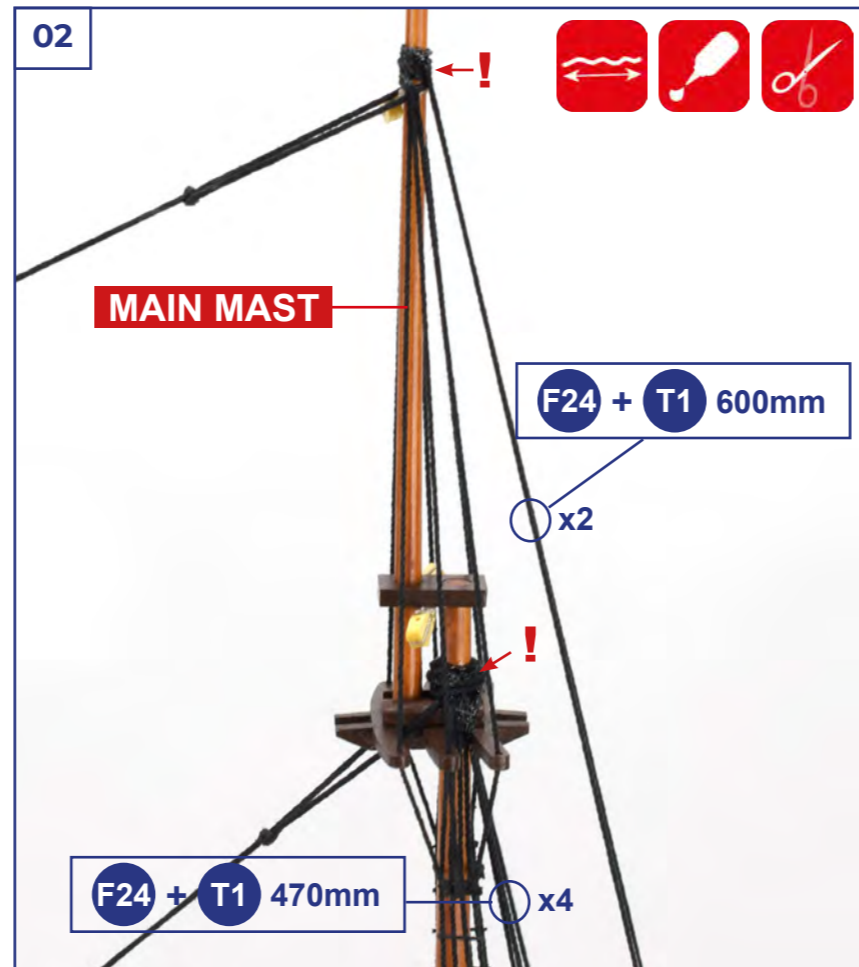
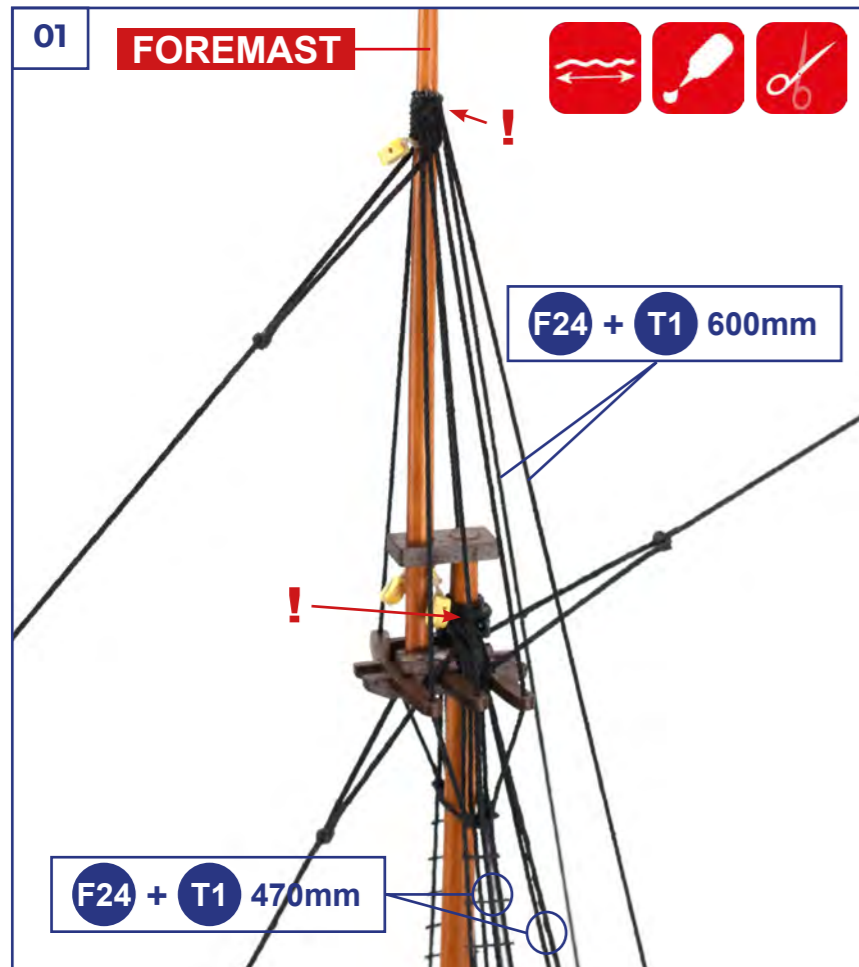

04

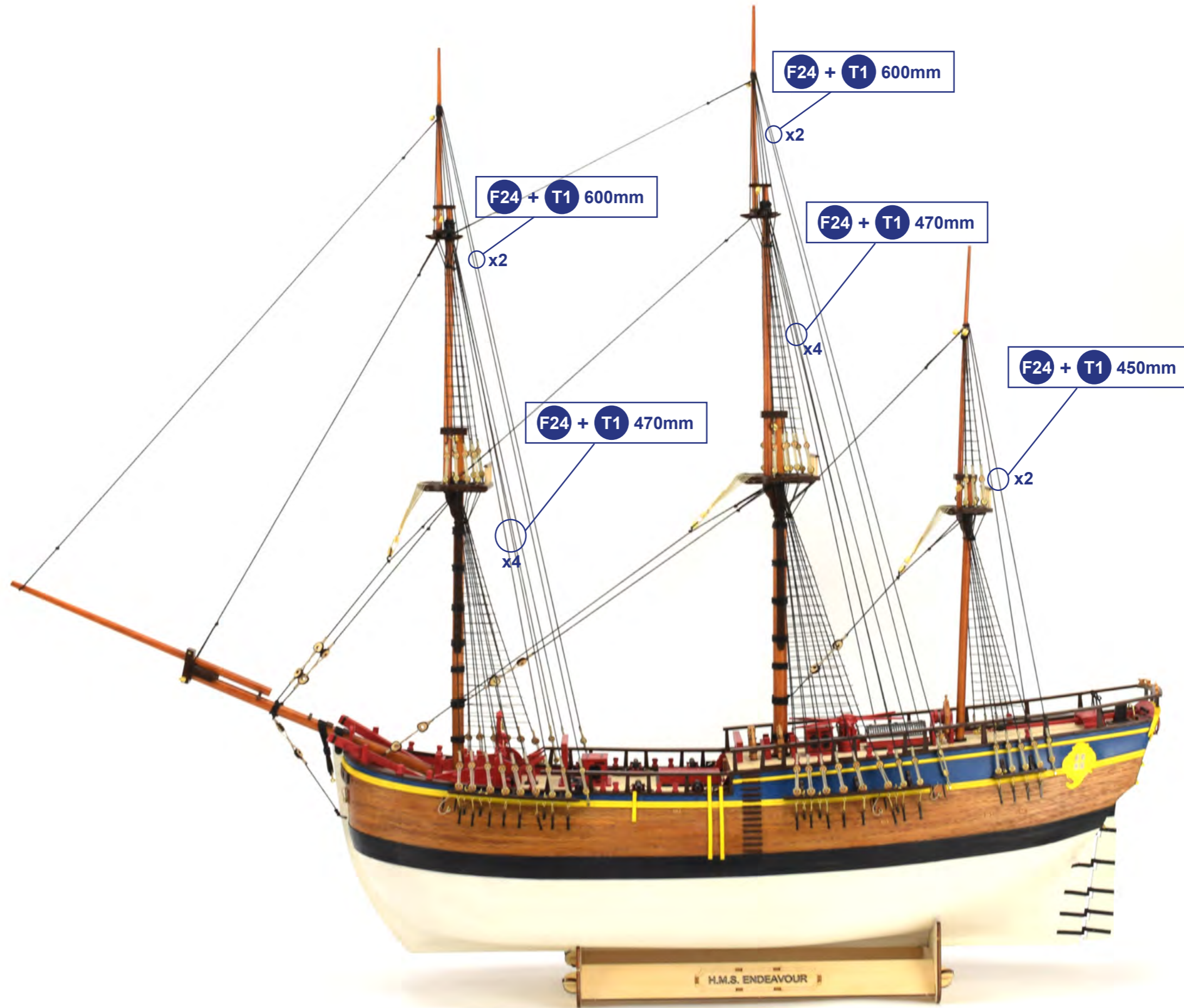

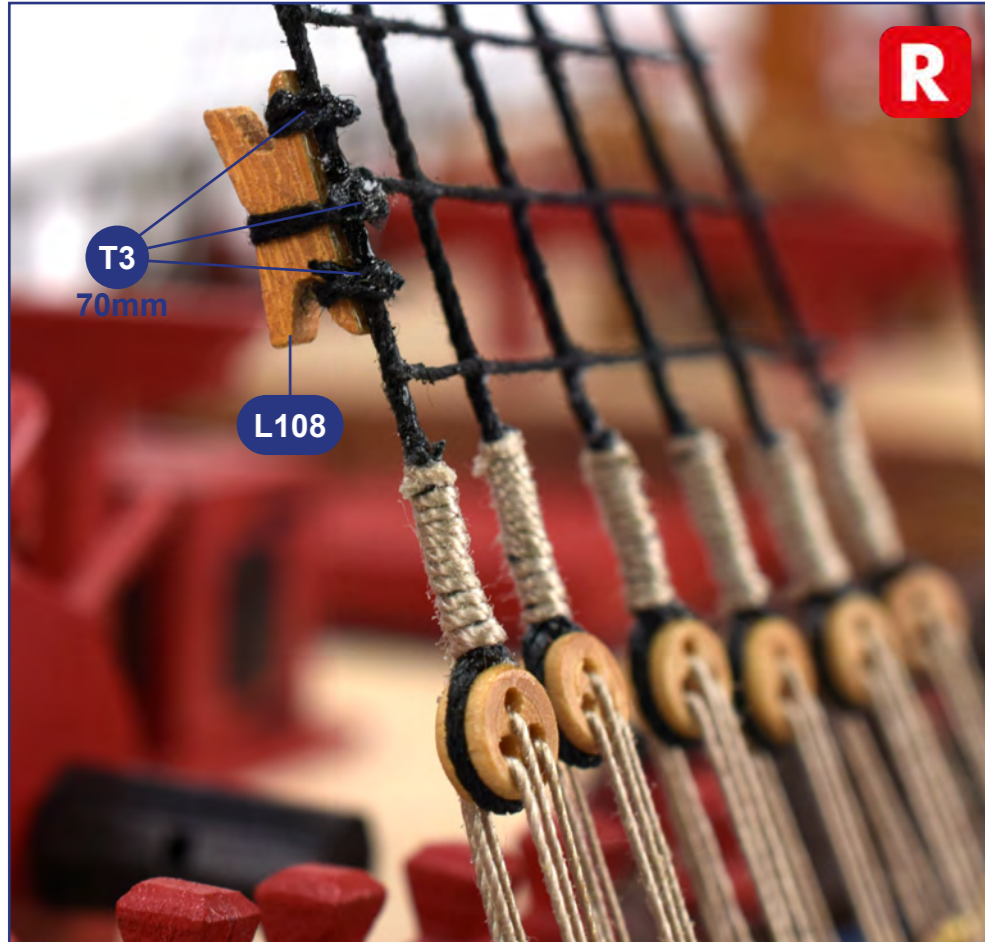
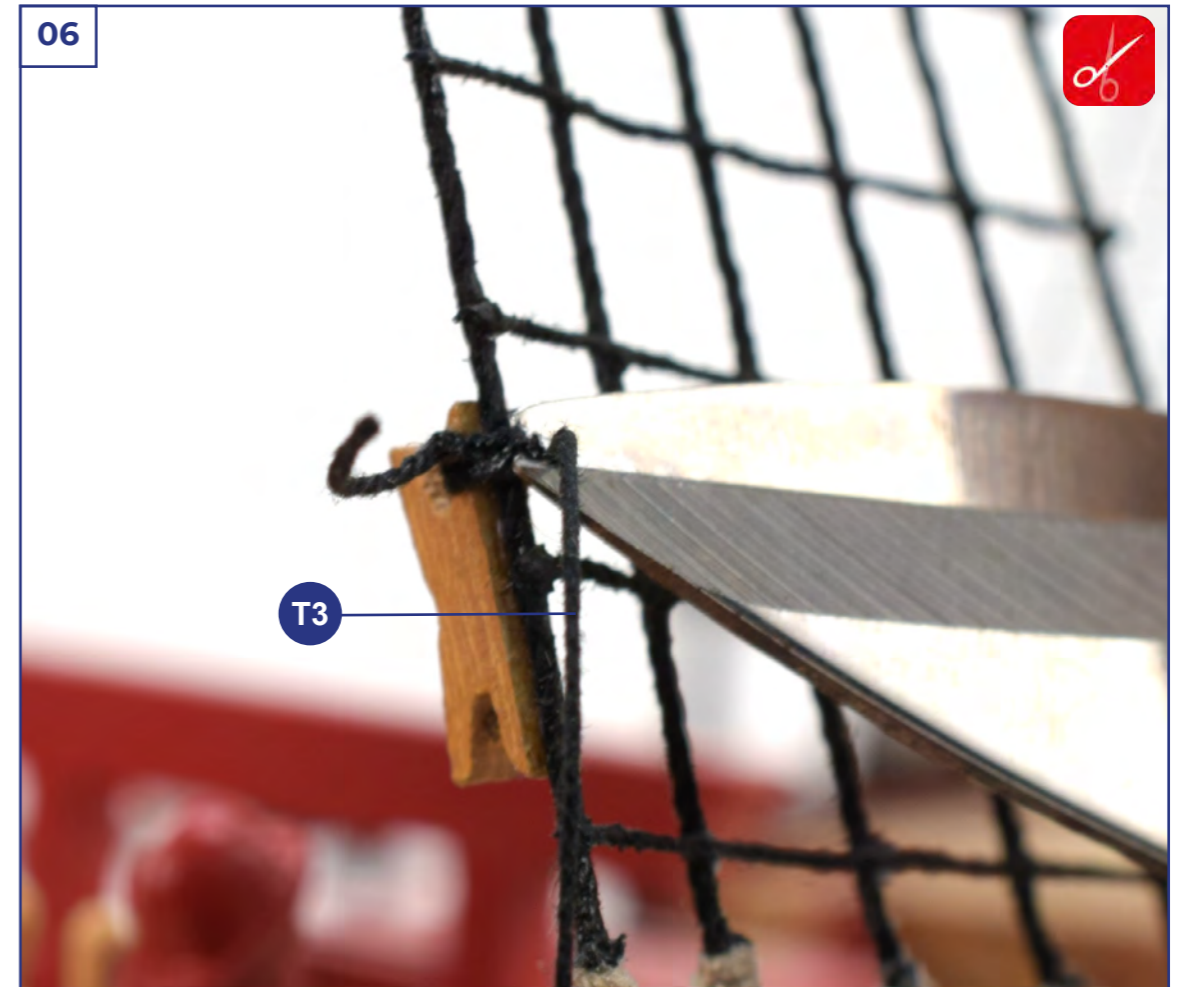
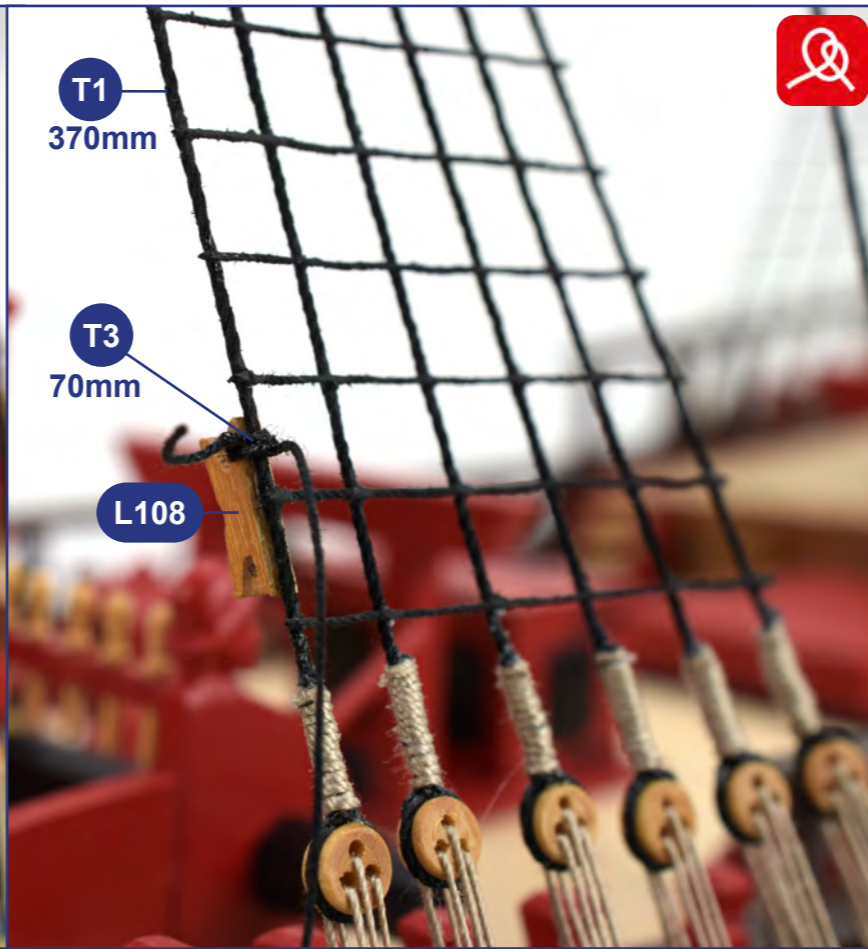

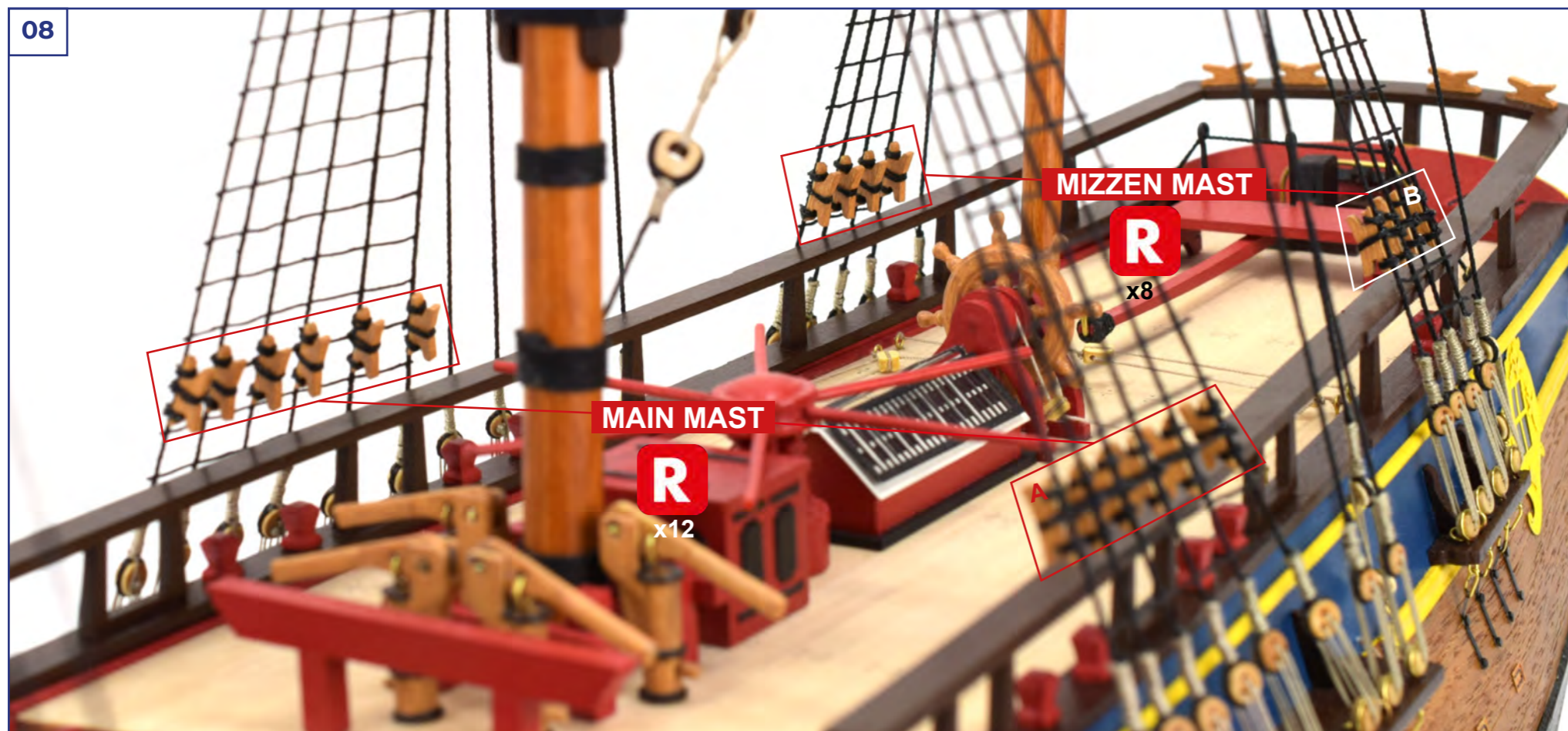
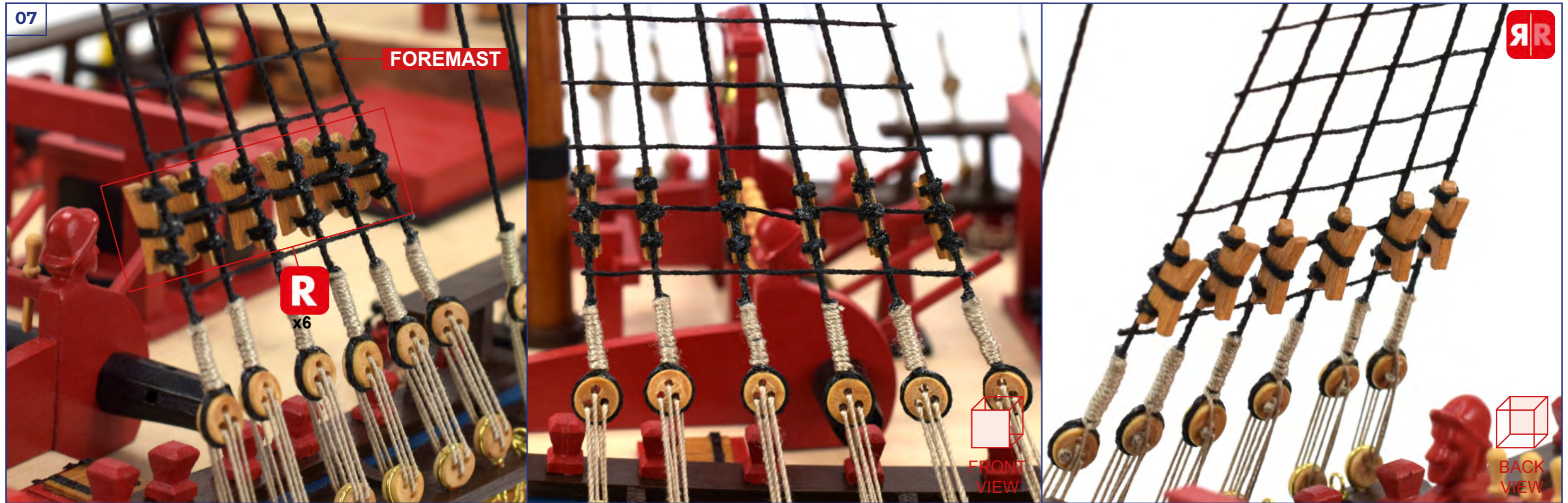

11



12

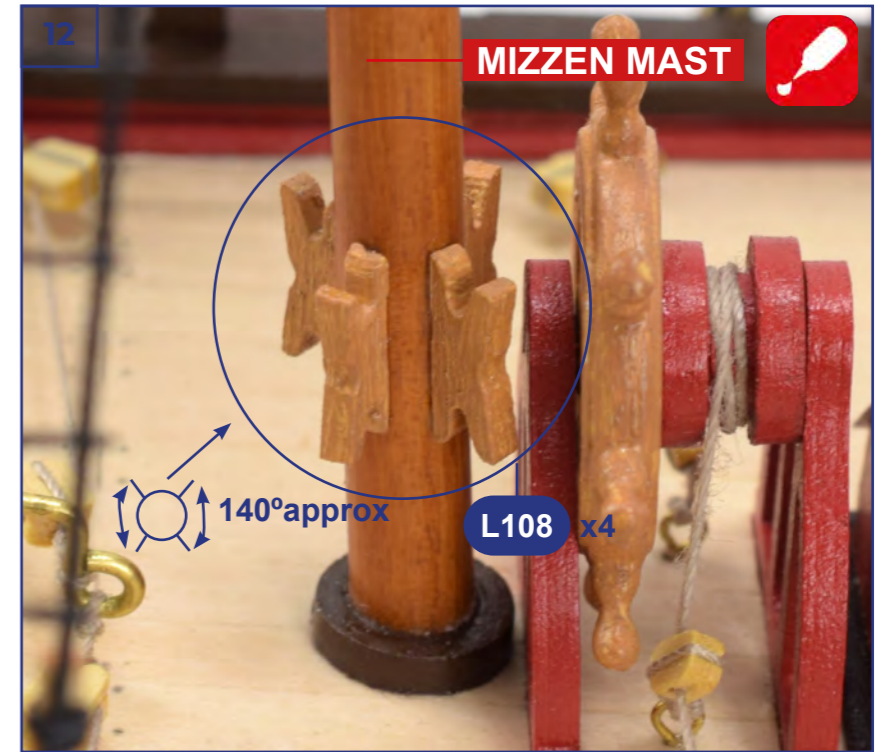

13

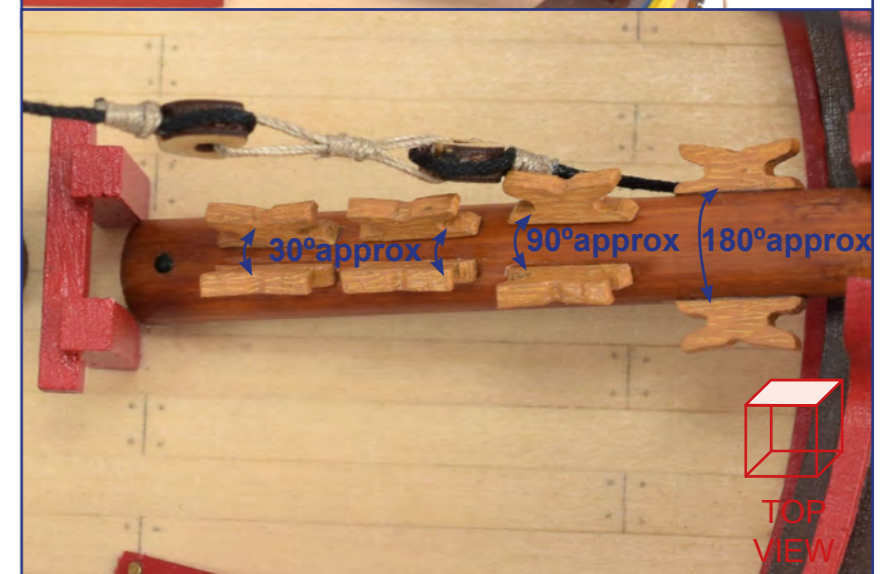
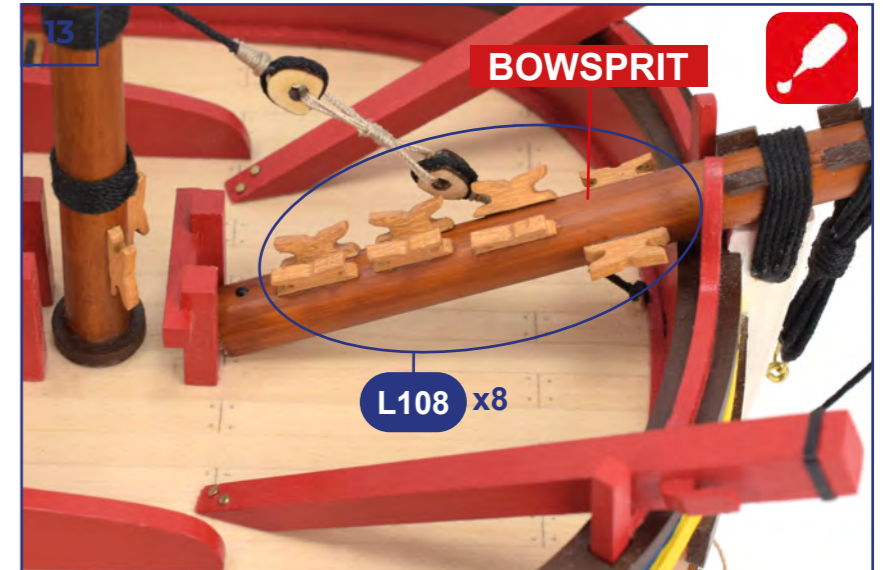

01

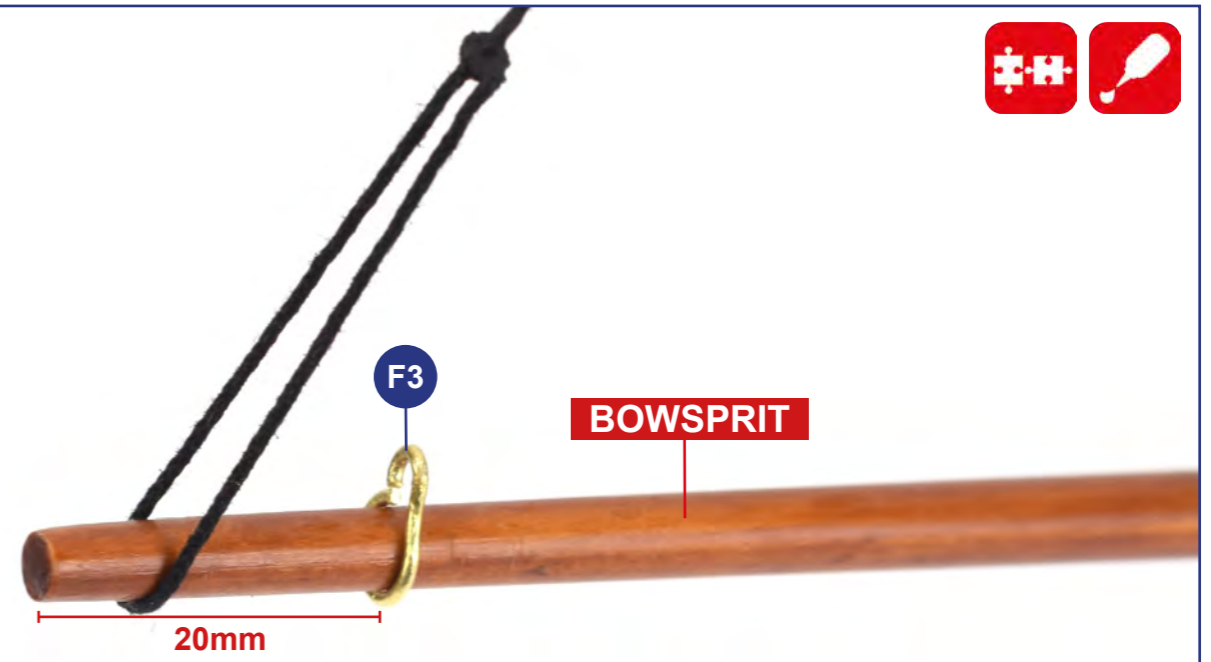

LEFT VIEW

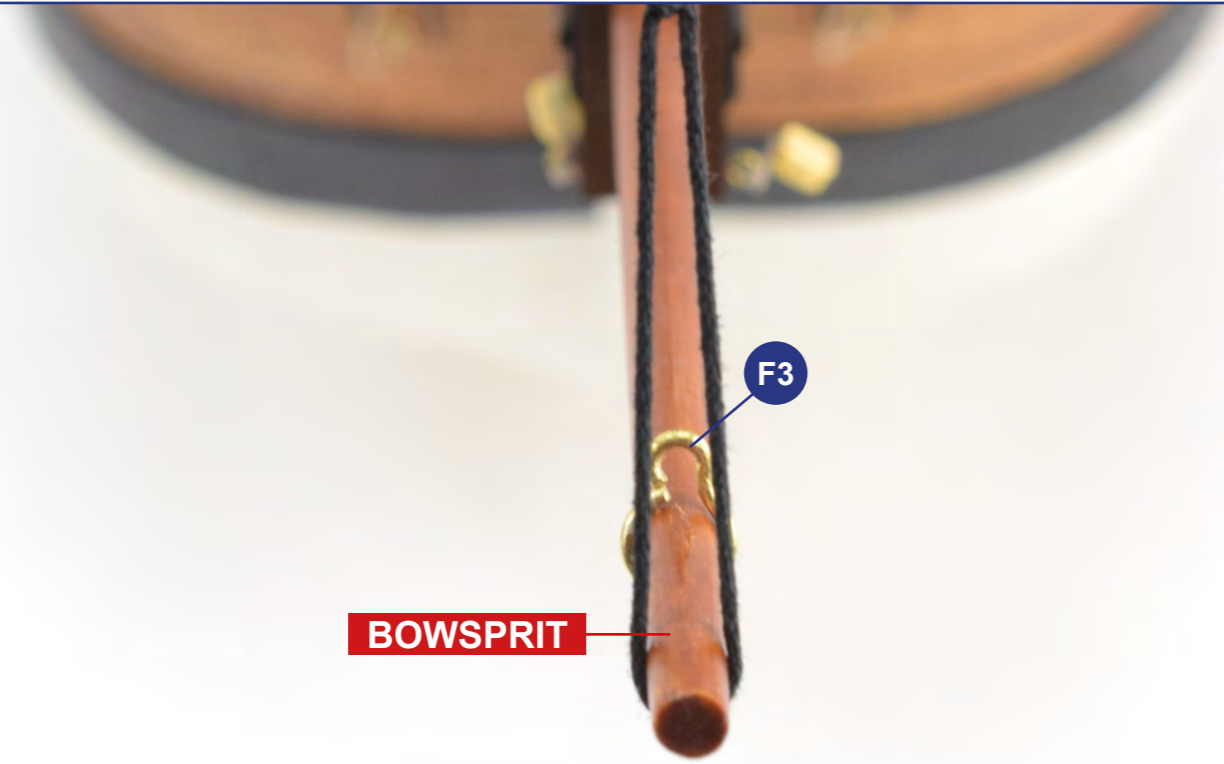

BOWSPRIT

F3



FRONT VIEW



RIGHT VIEW

02

Liquid for brass bluing
ref. 27795
Sold separately

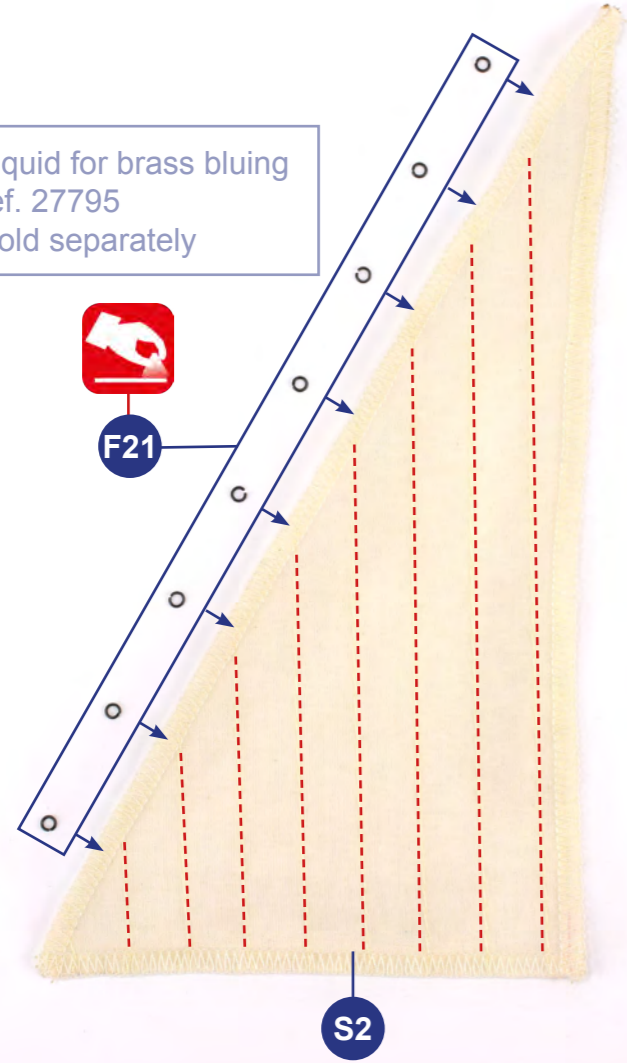

03

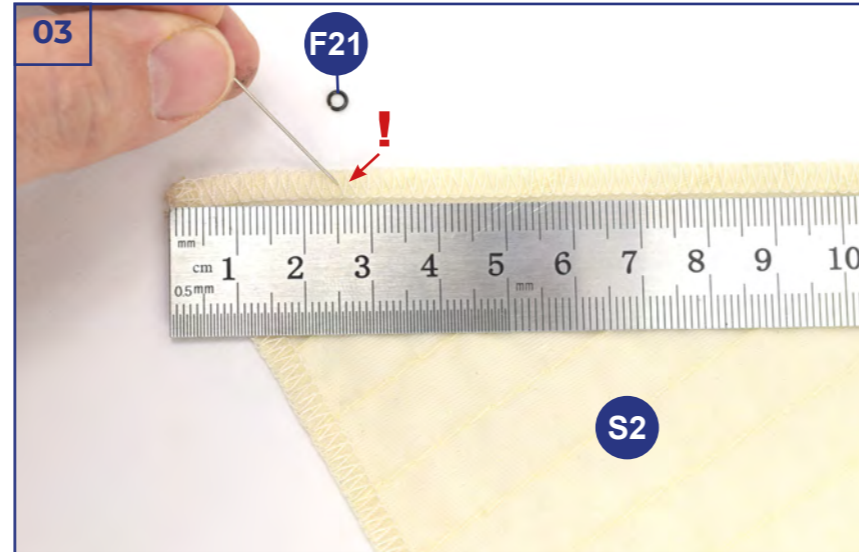

04



05

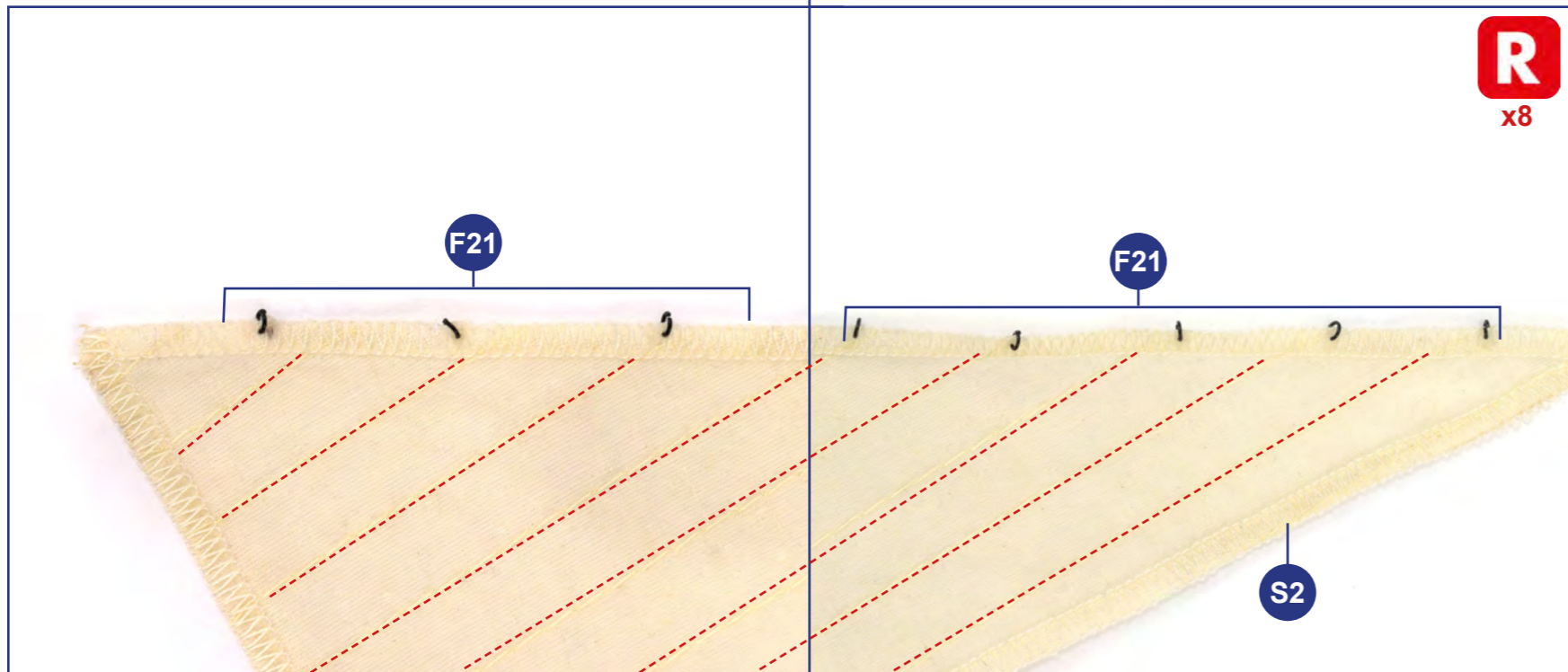

06

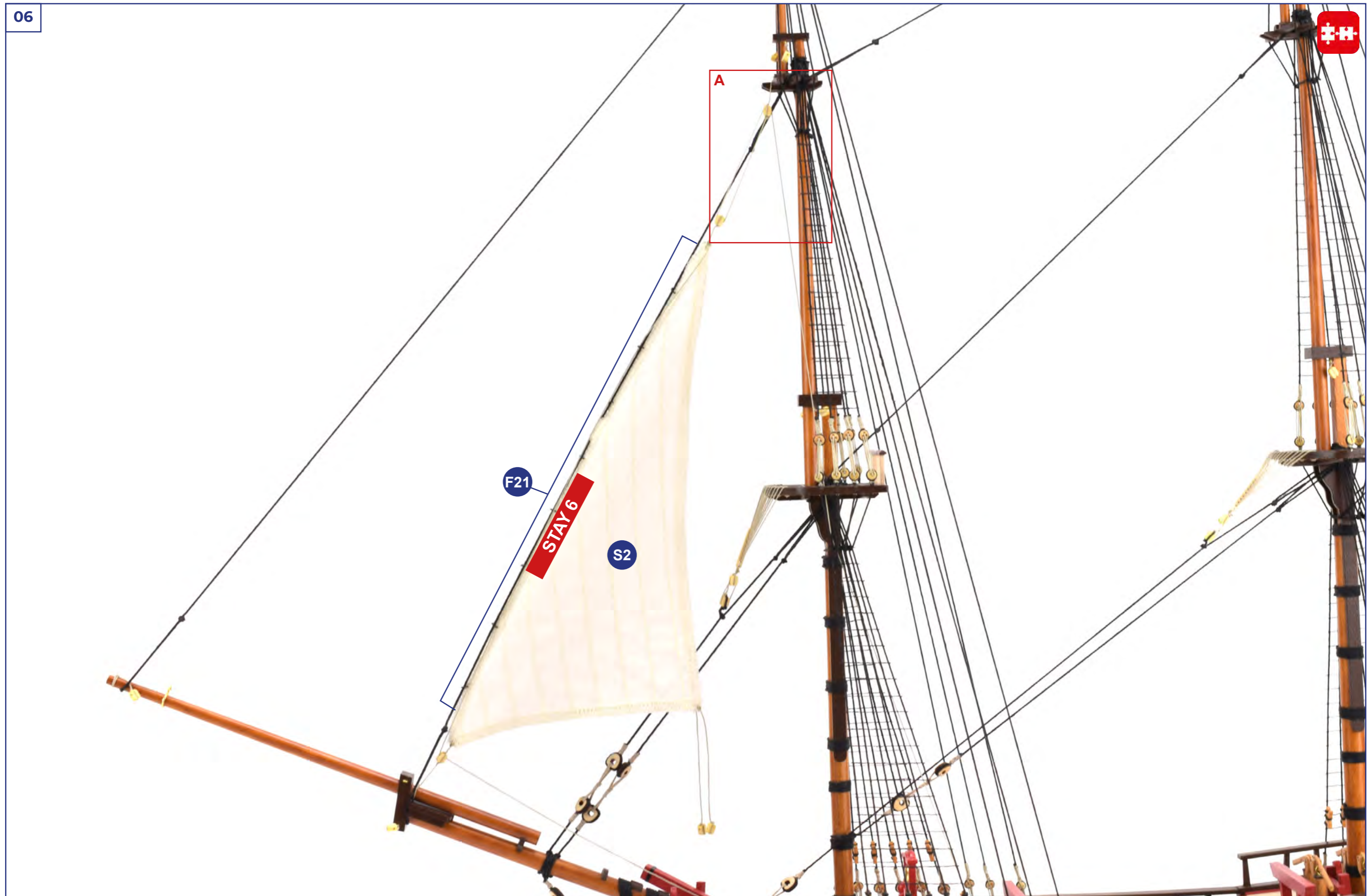

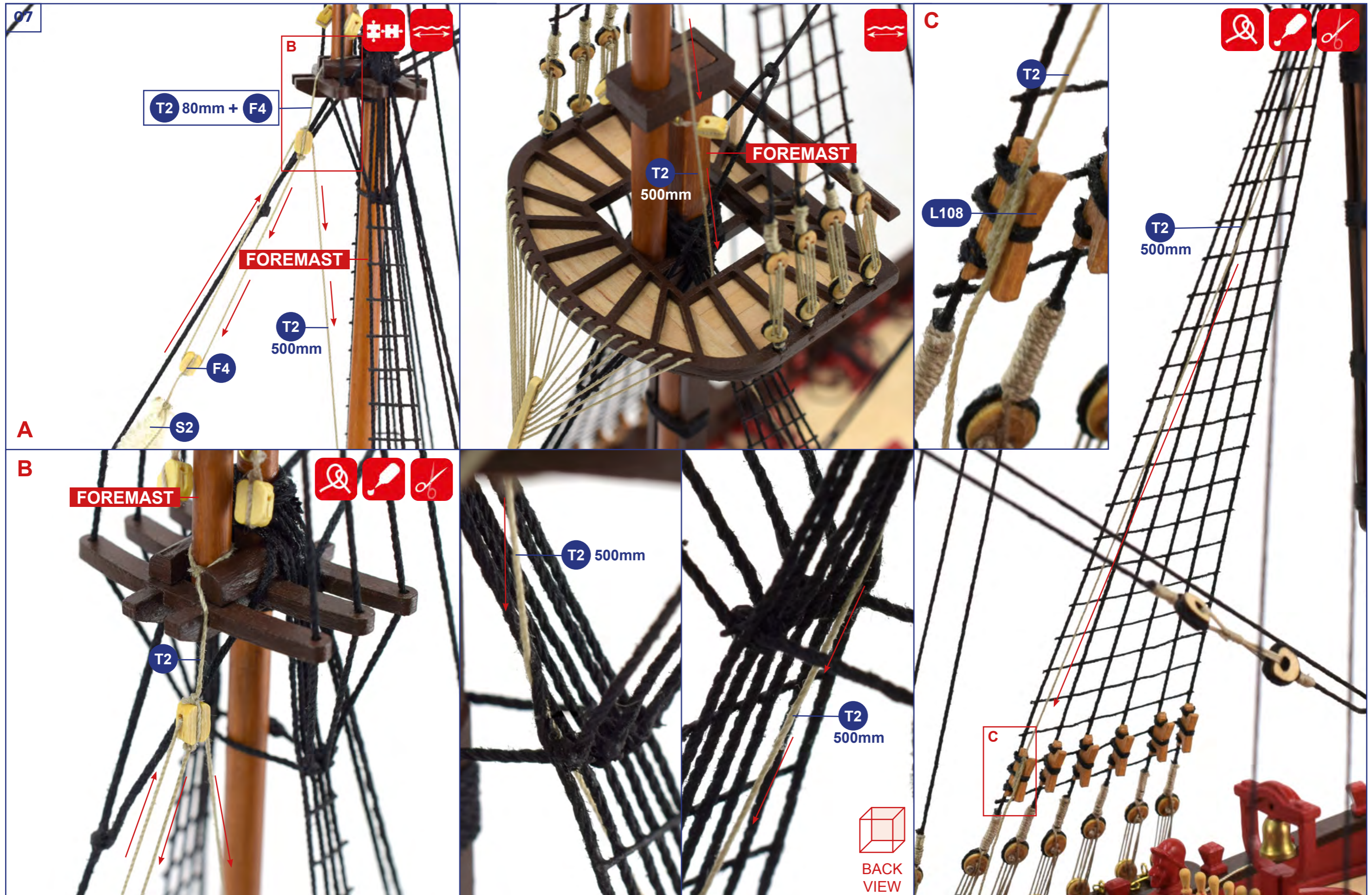

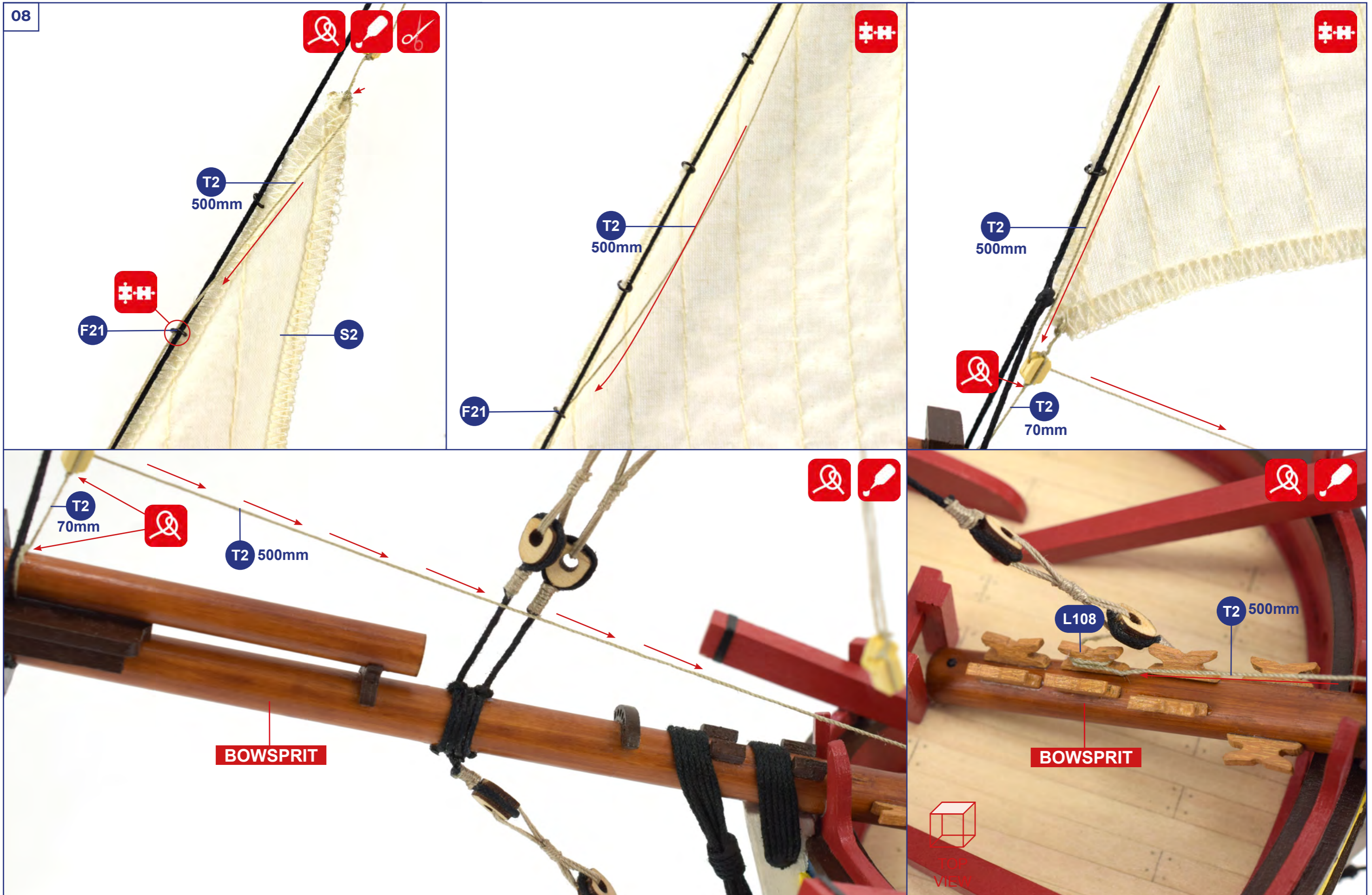

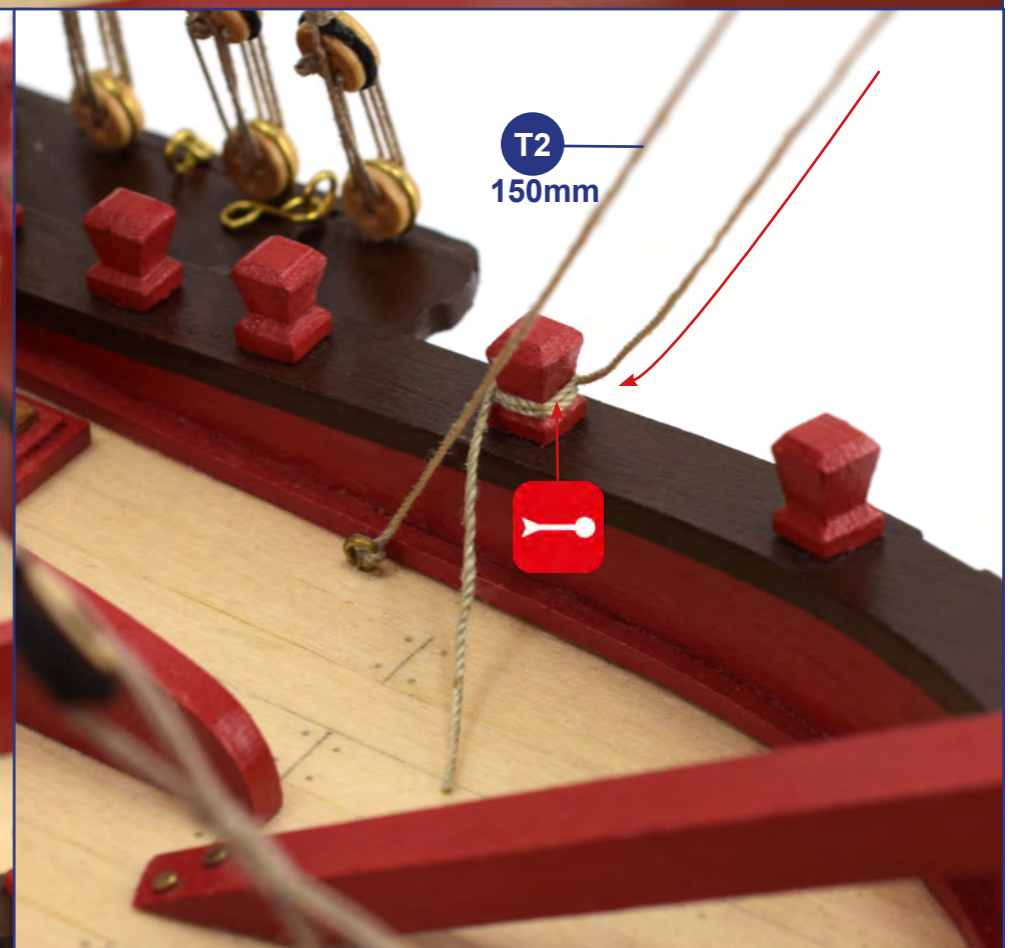
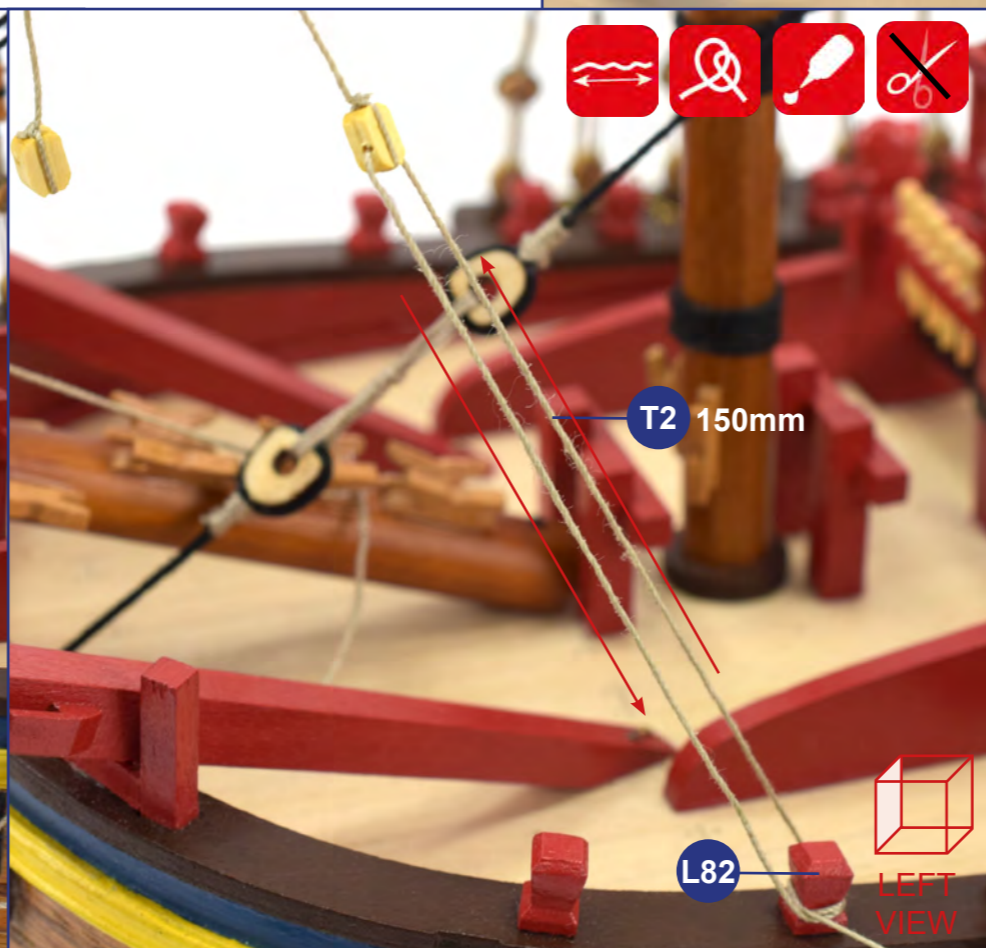
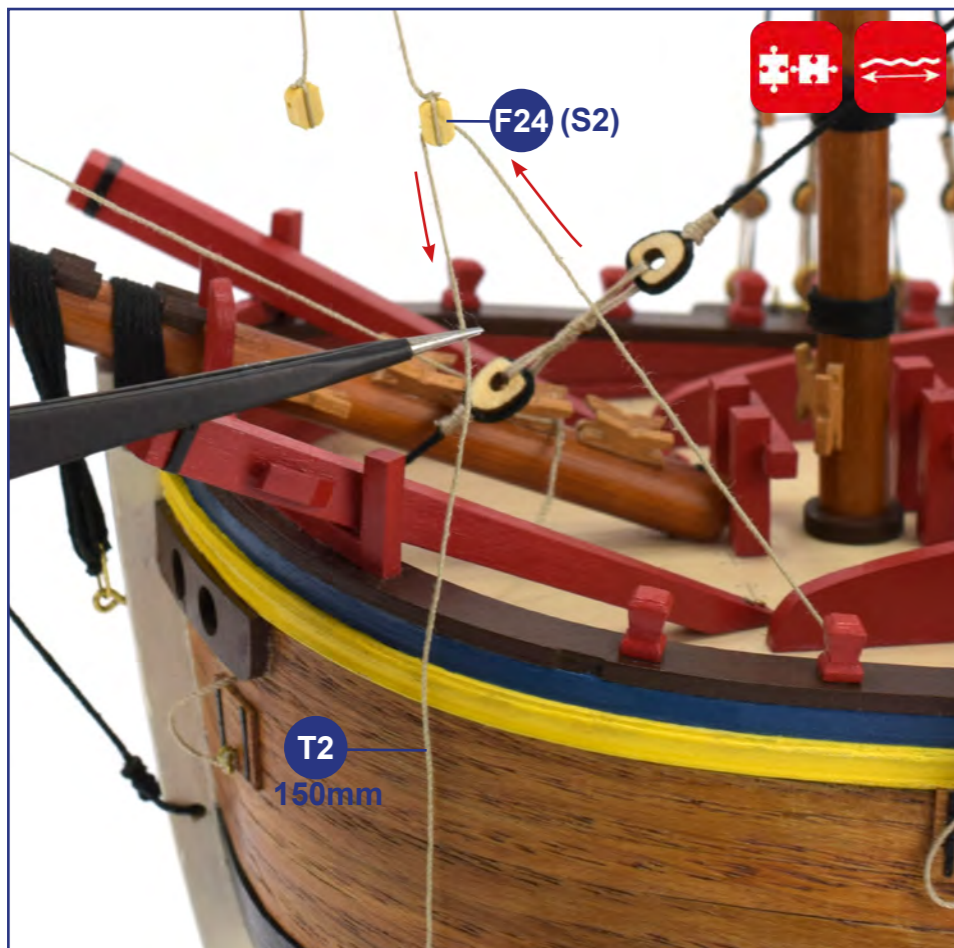
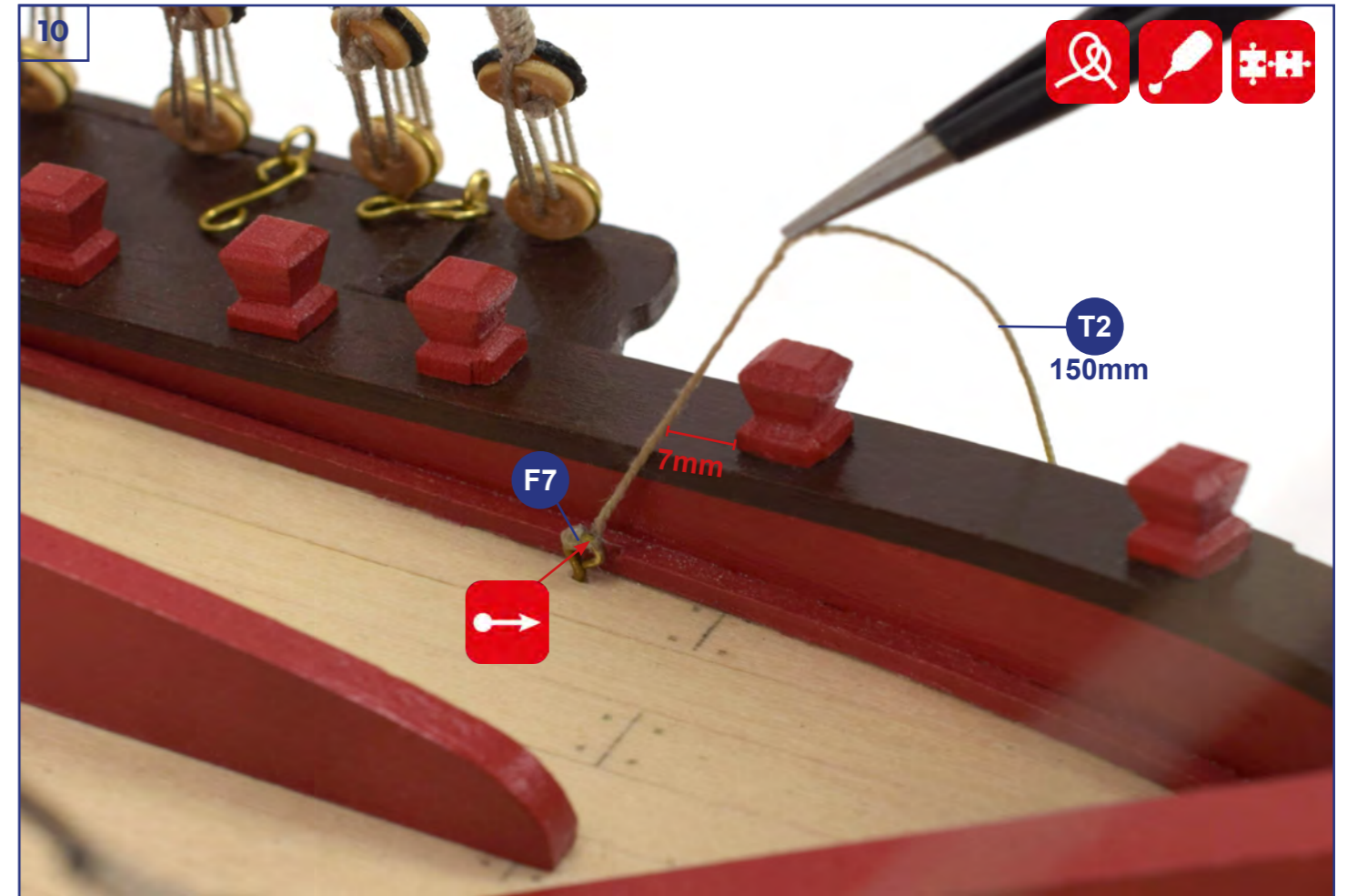
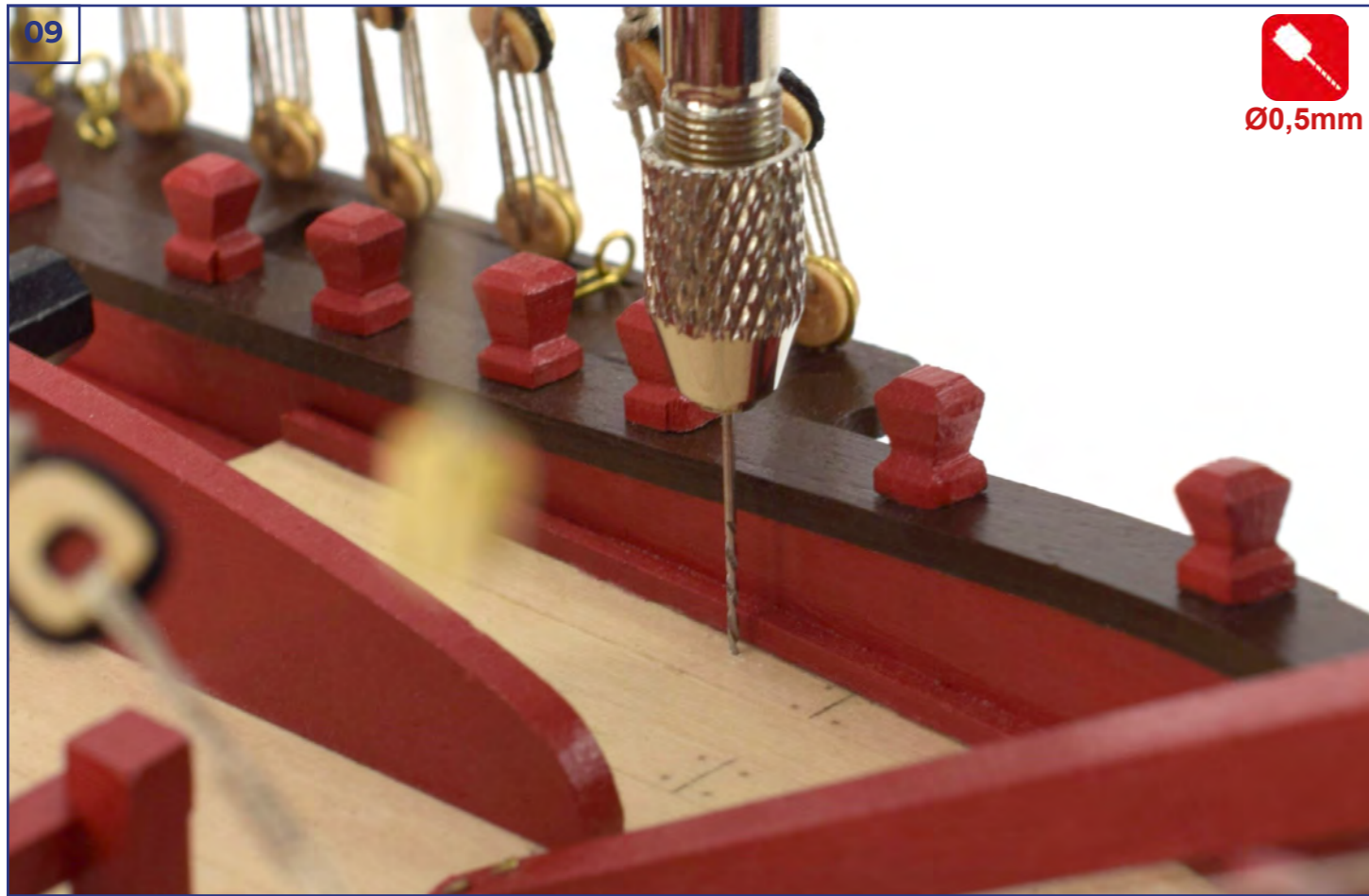

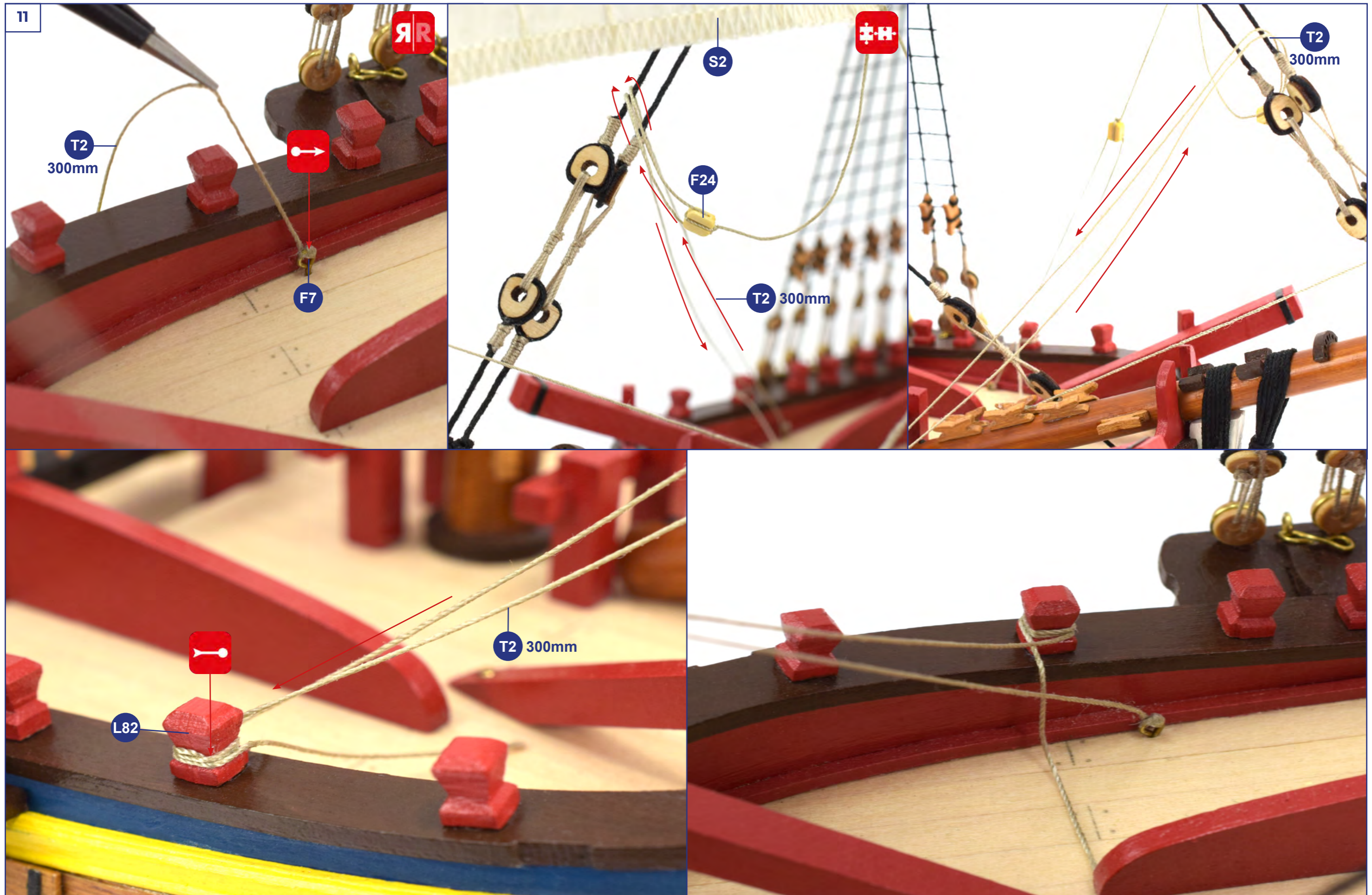

01

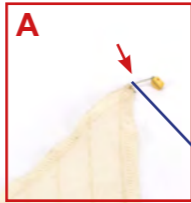

T2 80mm + F4

S1

T2 80mm

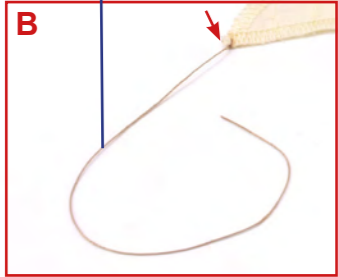

T2 130mm + F4

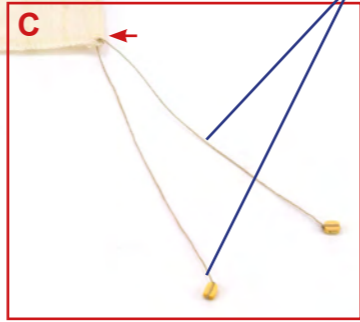

A



B



C



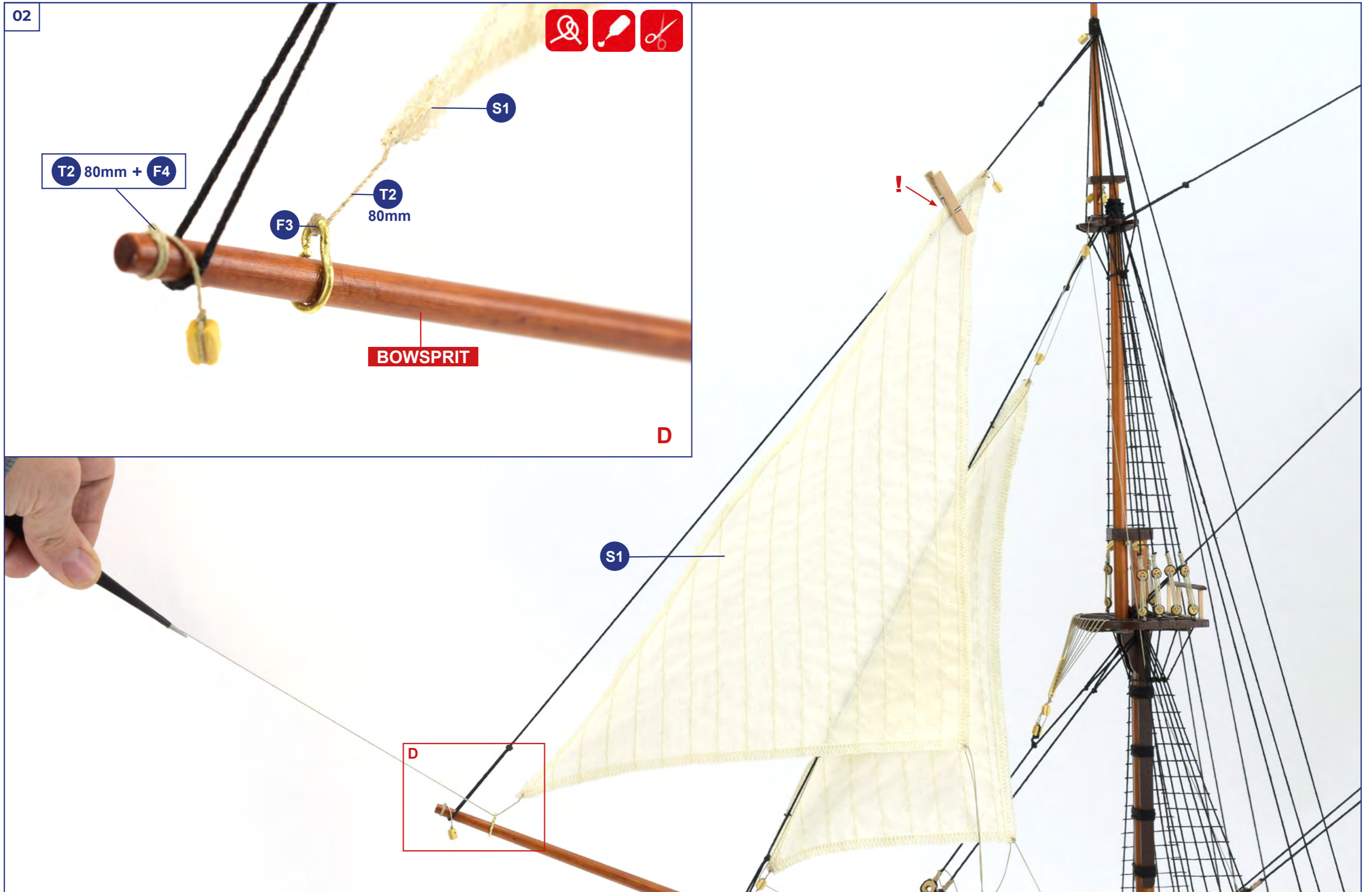

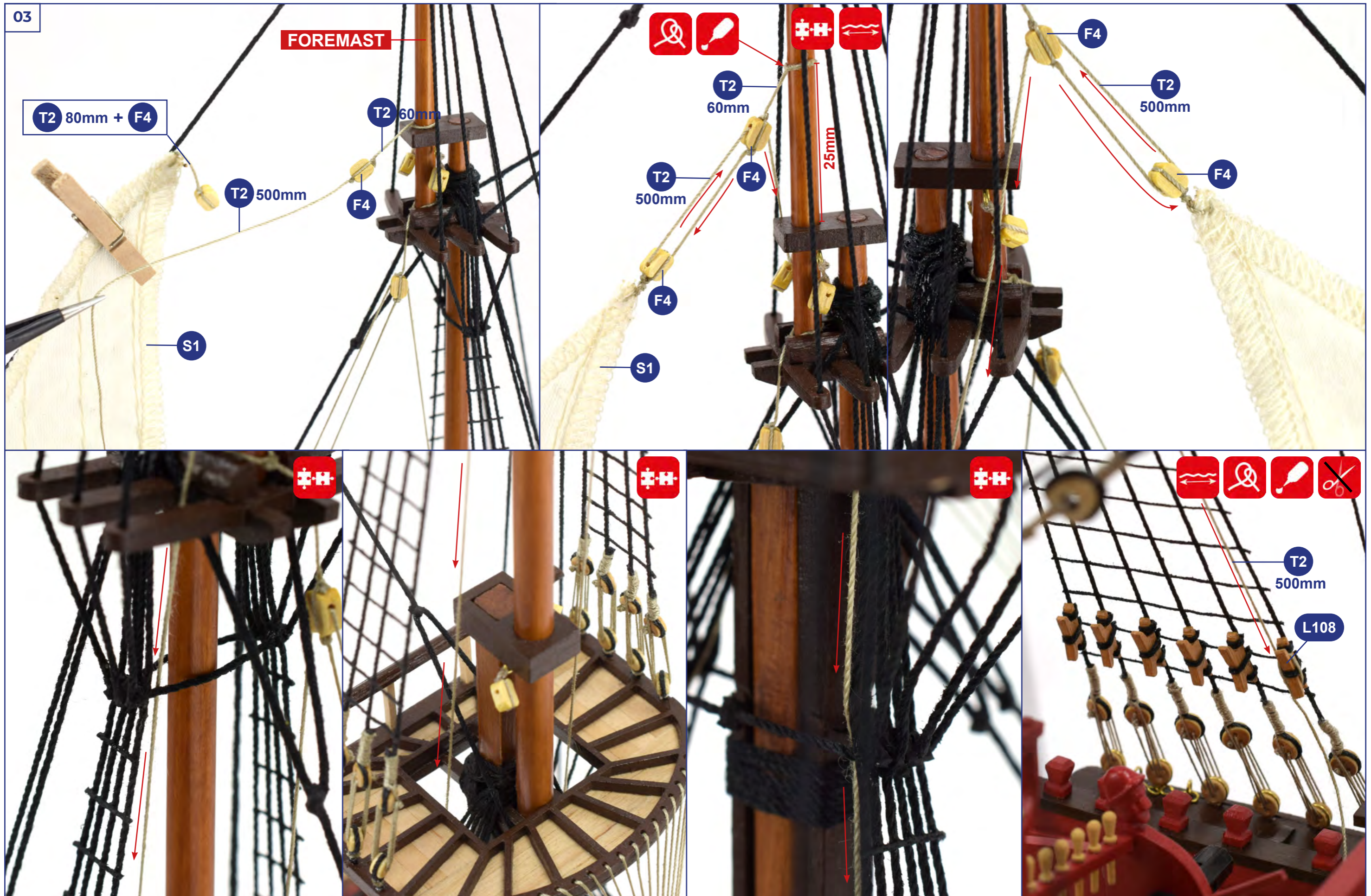

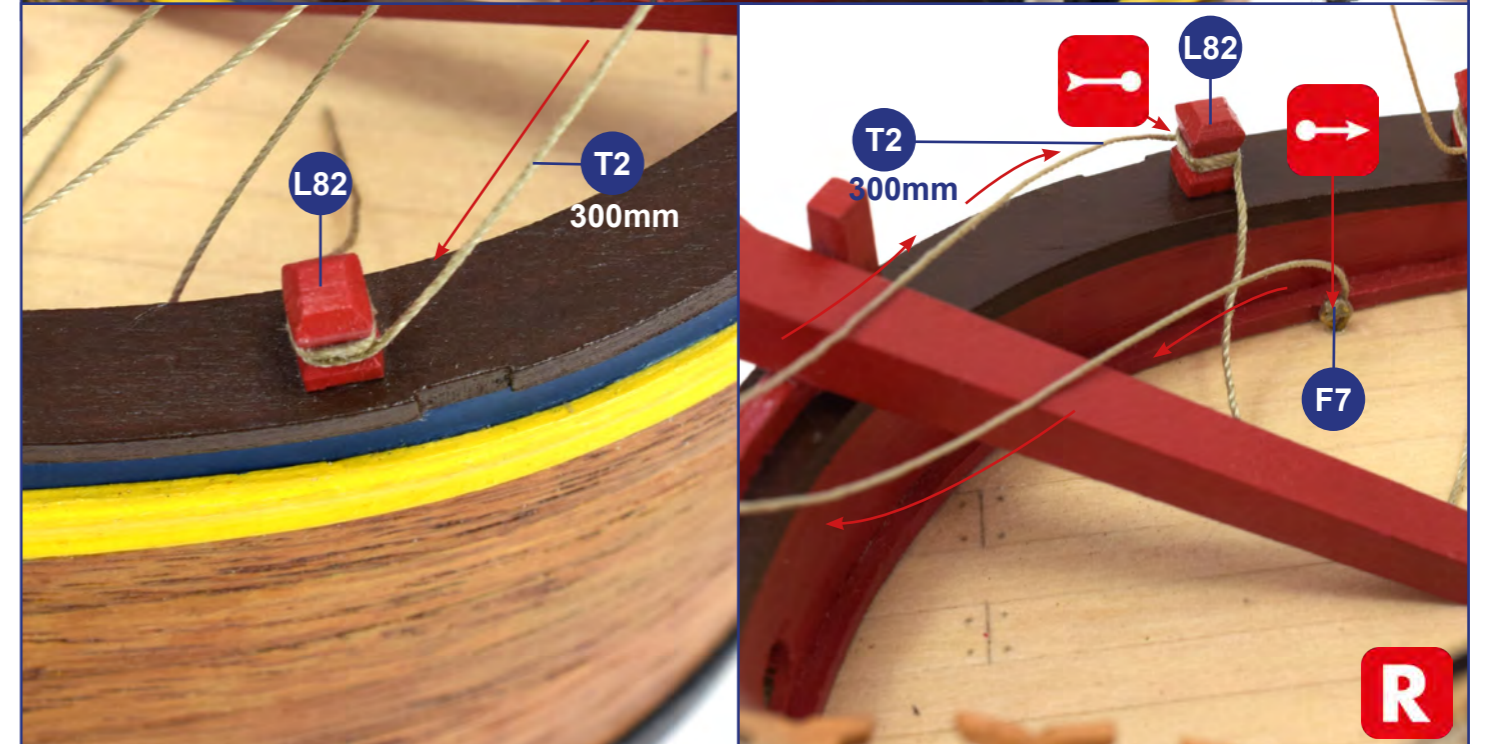
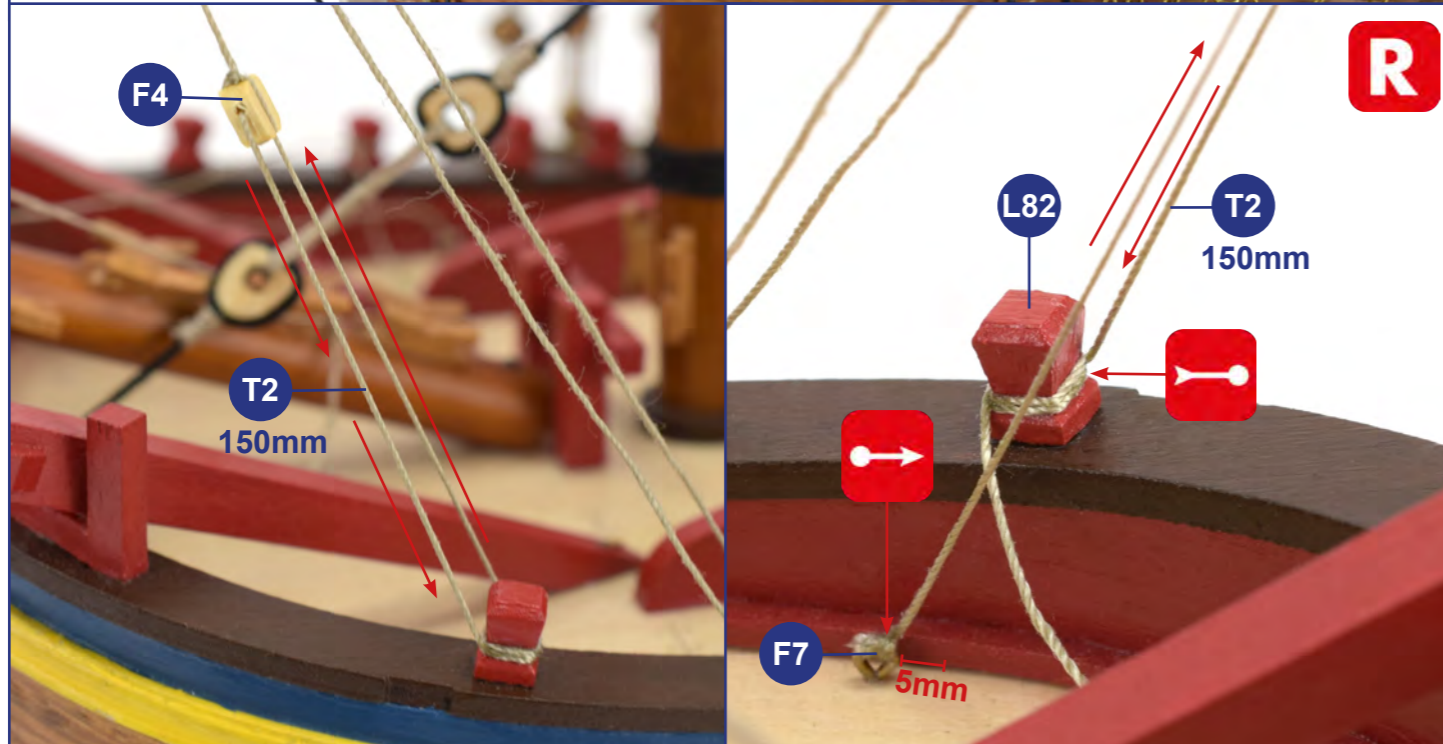
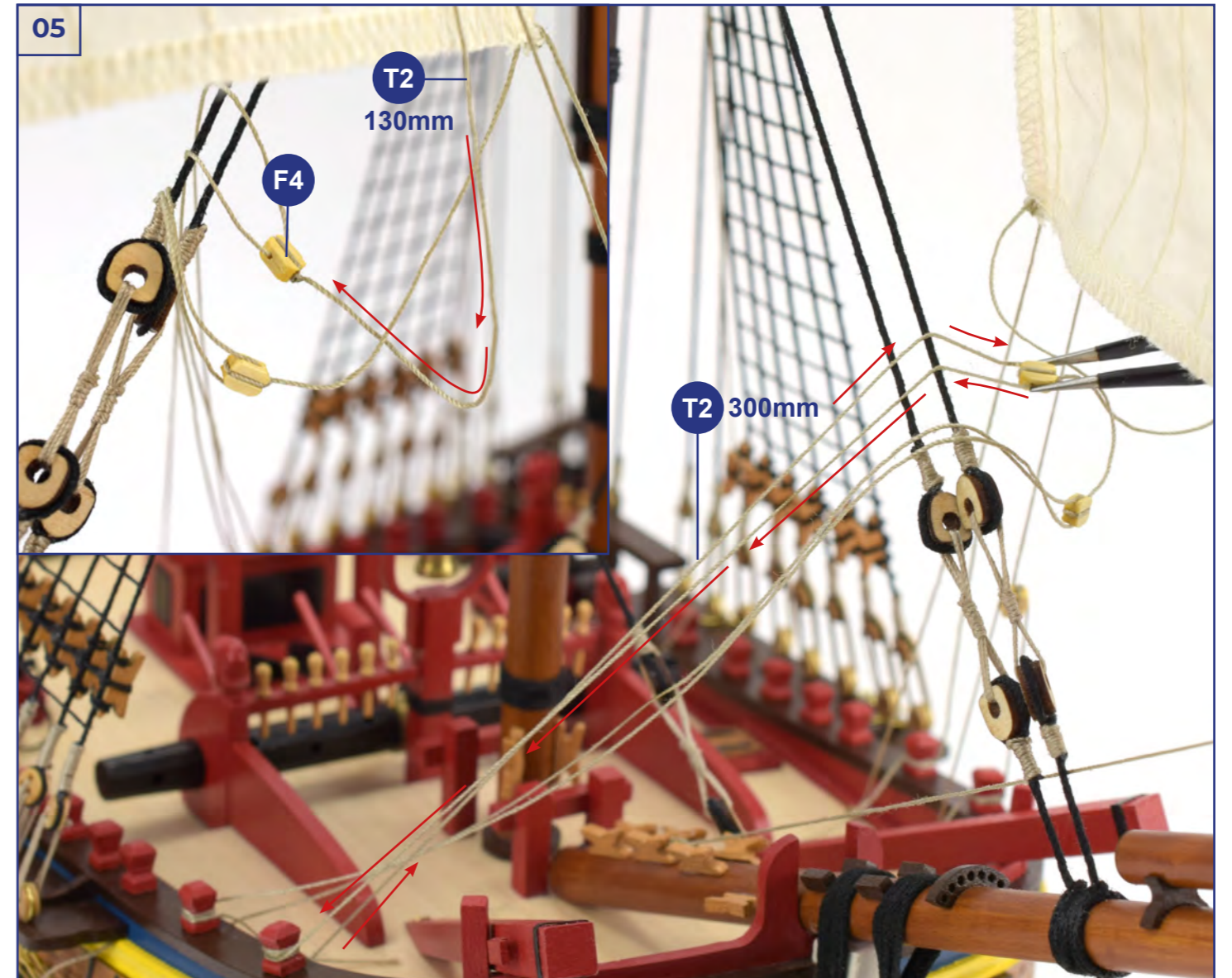

06



BOWSPRIT

F3

F4

T2
150mm



Ø0,5mm

T2 150mm + F4

T2 80mm + F4

F7

T2
300mm



T2 300mm

L108

E

T2
300mm

E

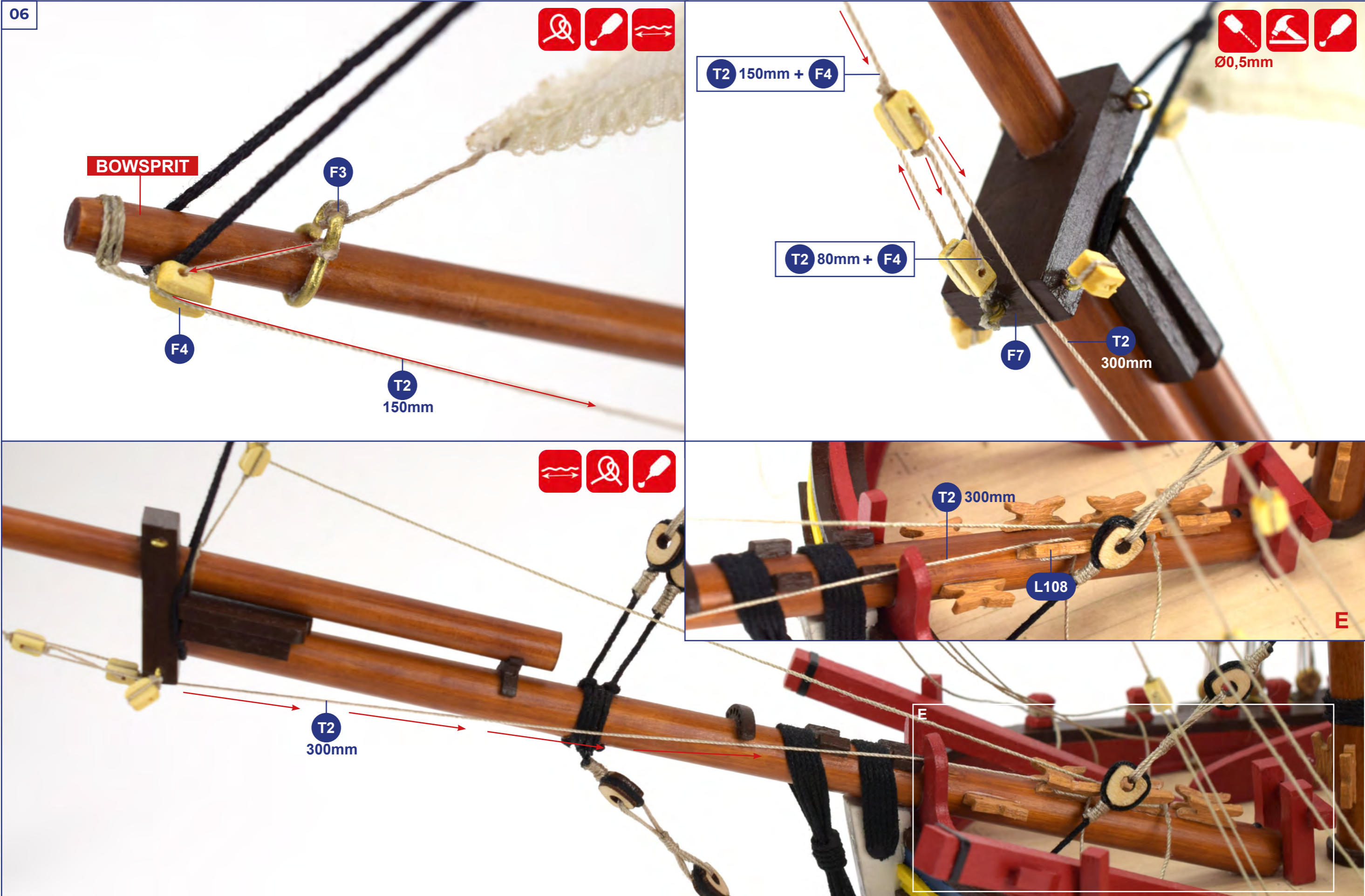

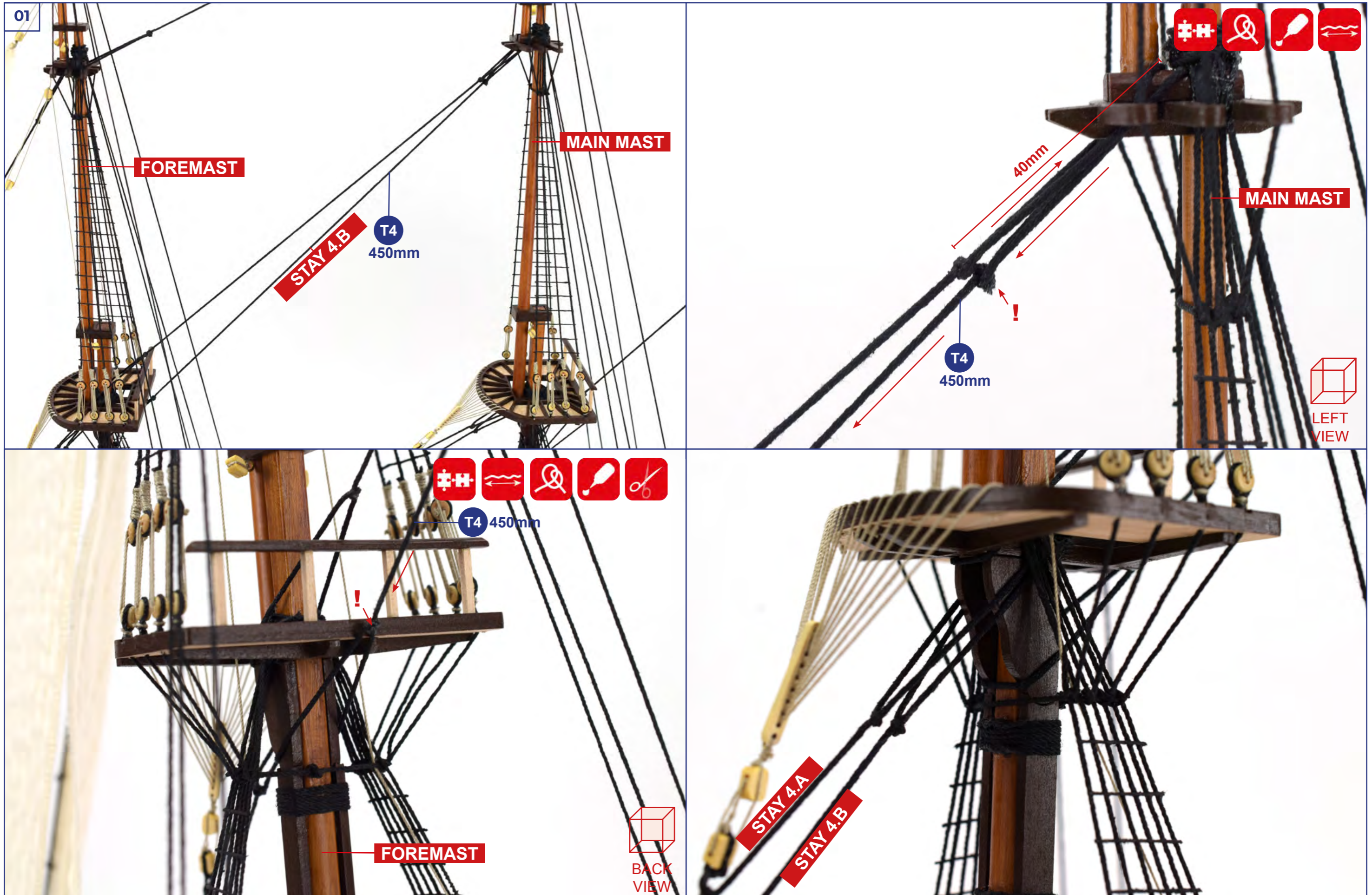

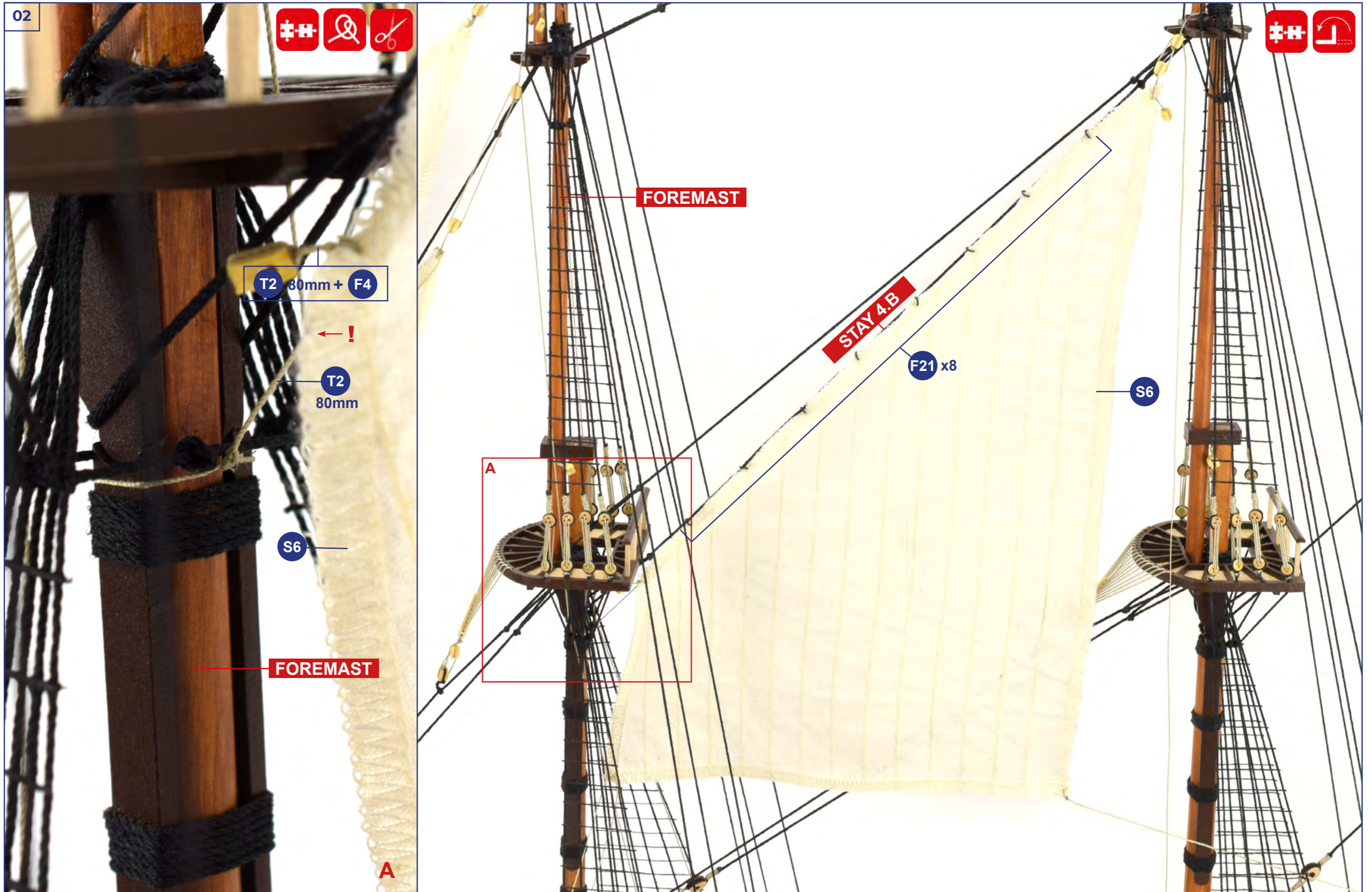

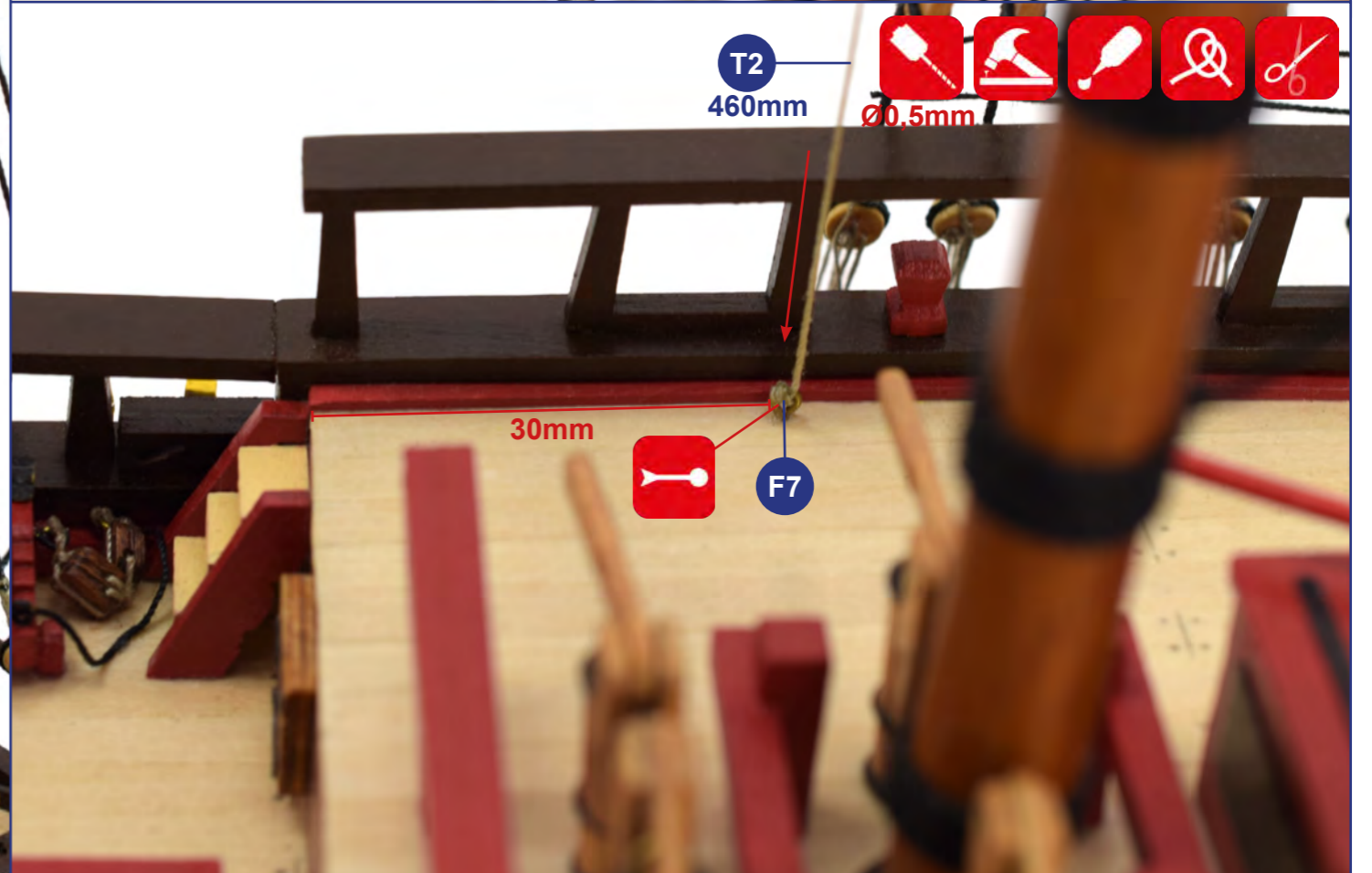
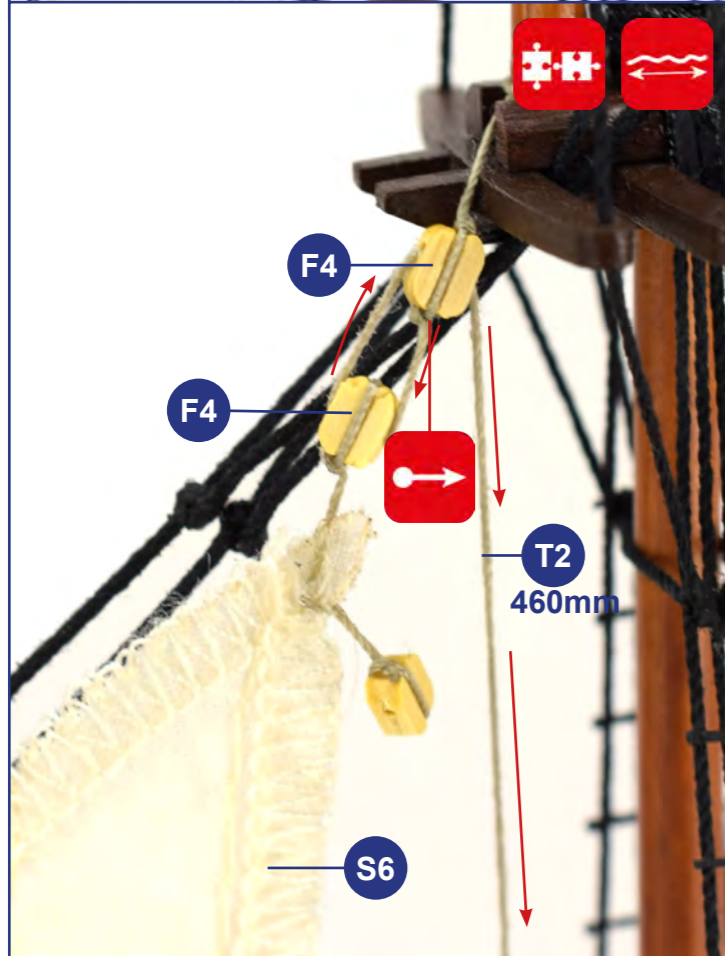
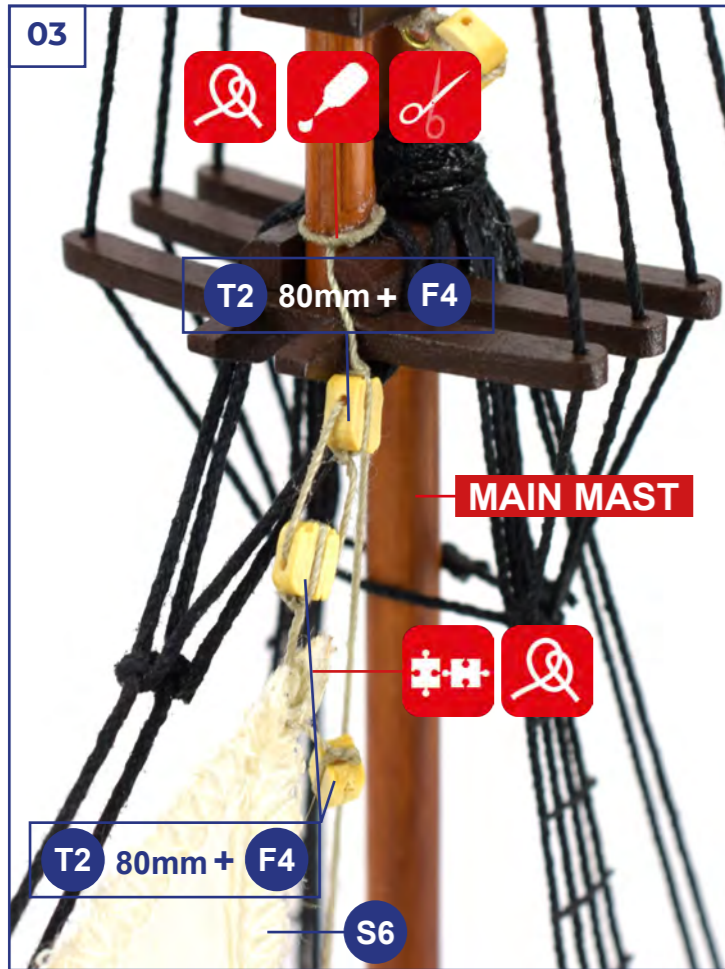

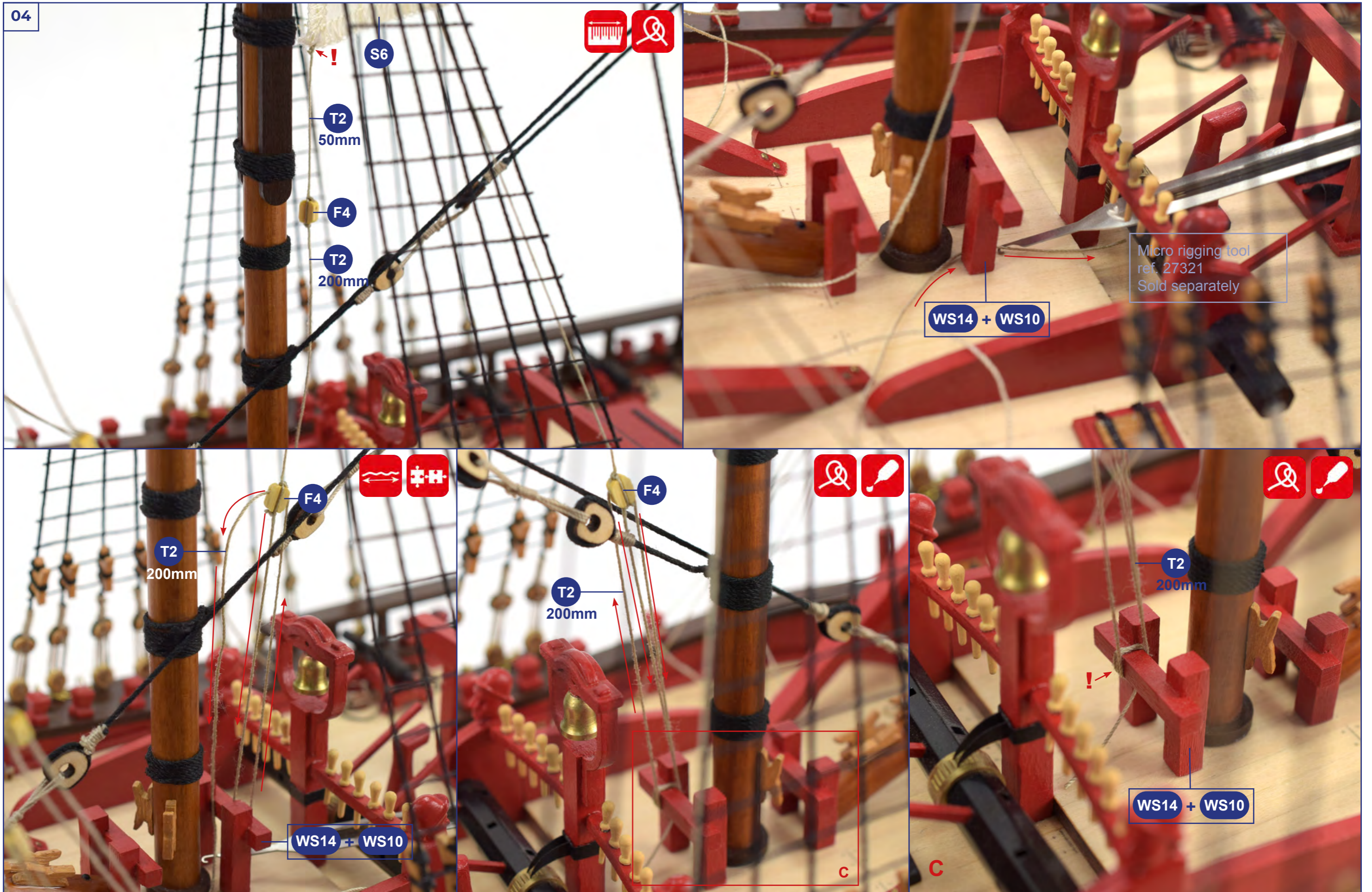

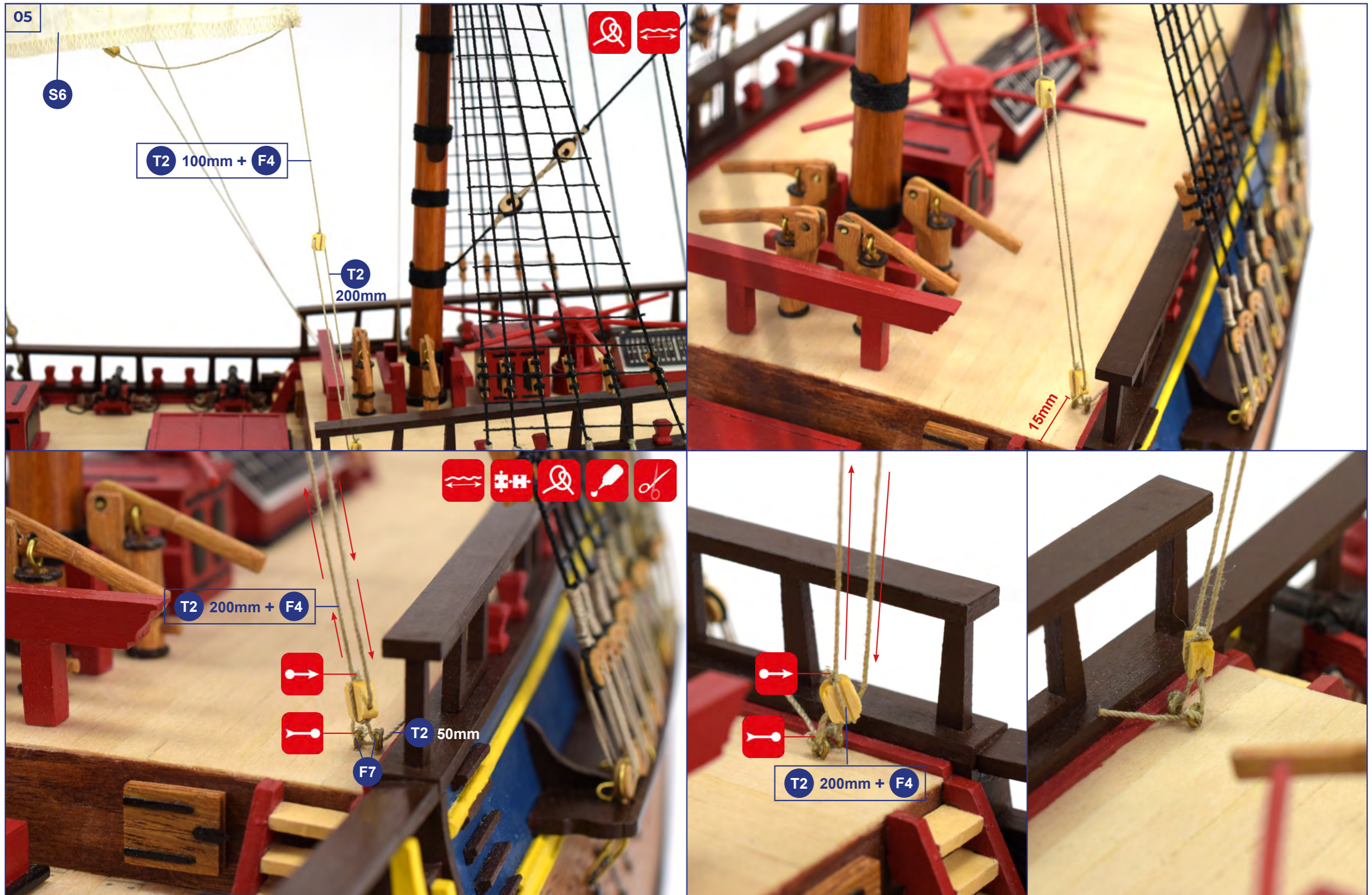

06

R

T2 100mm + F4

T2 450mm

S6

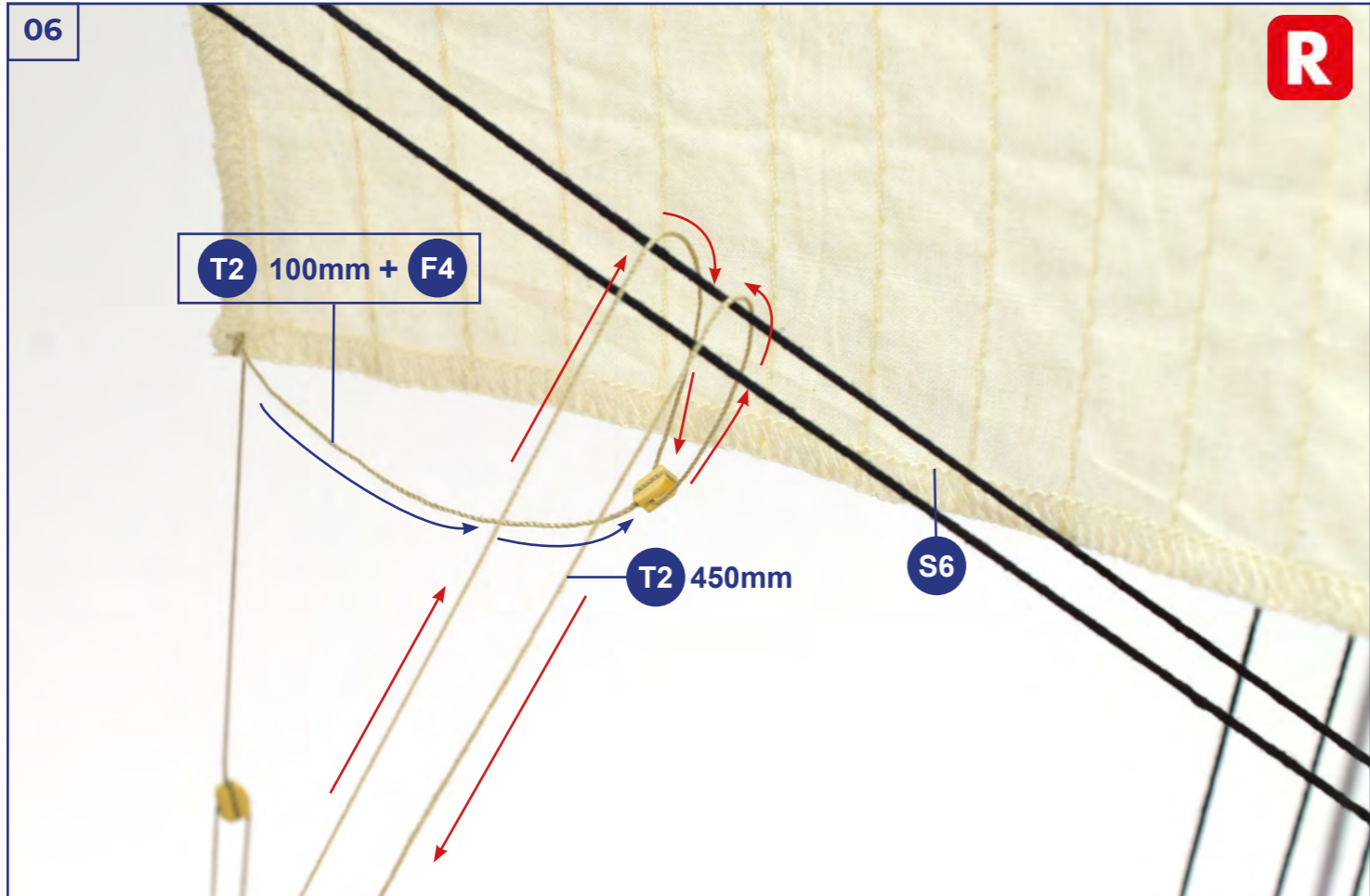

R

T2 50mm

T2 450mm

F7

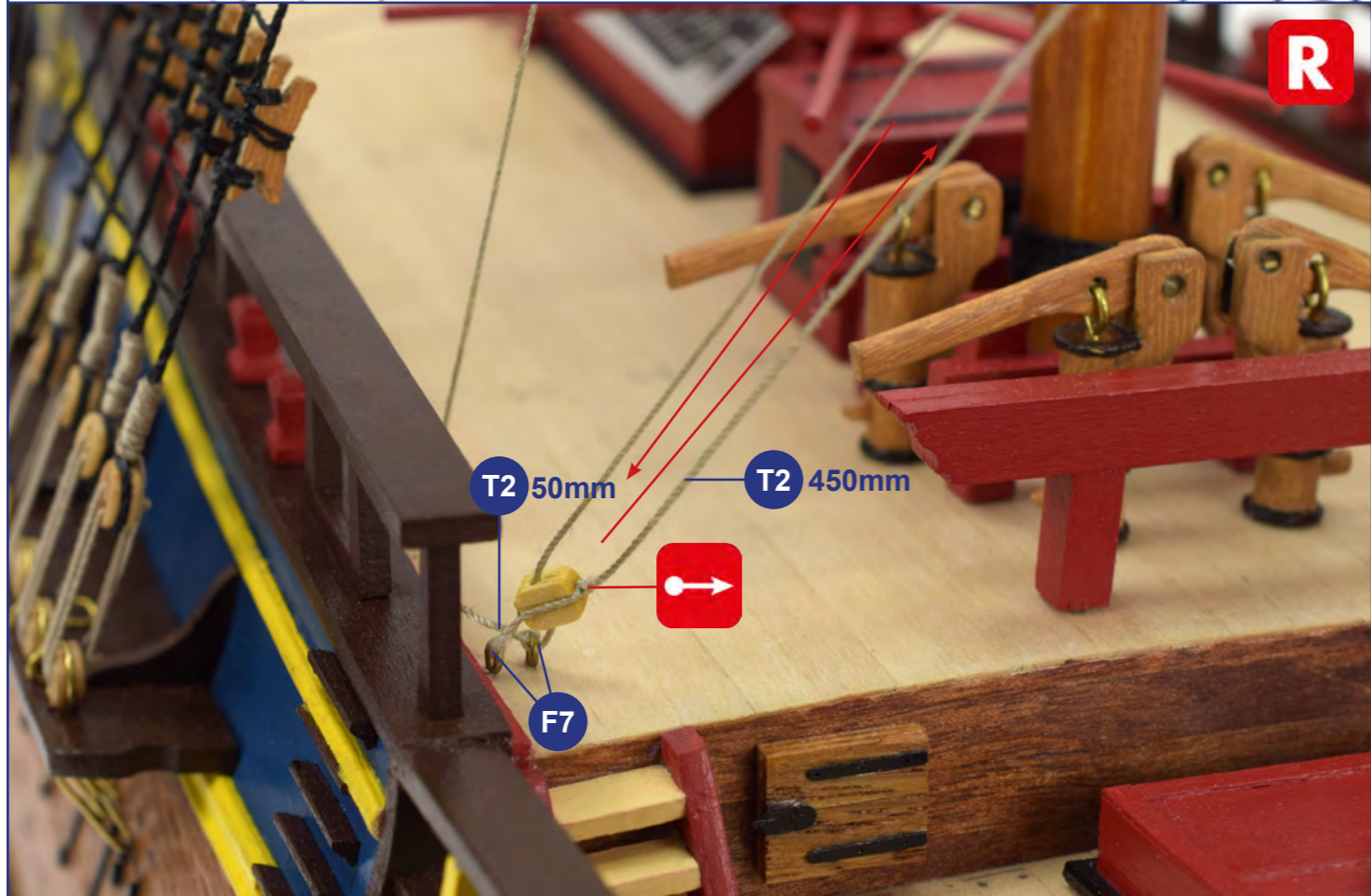

T2 450mm

F4

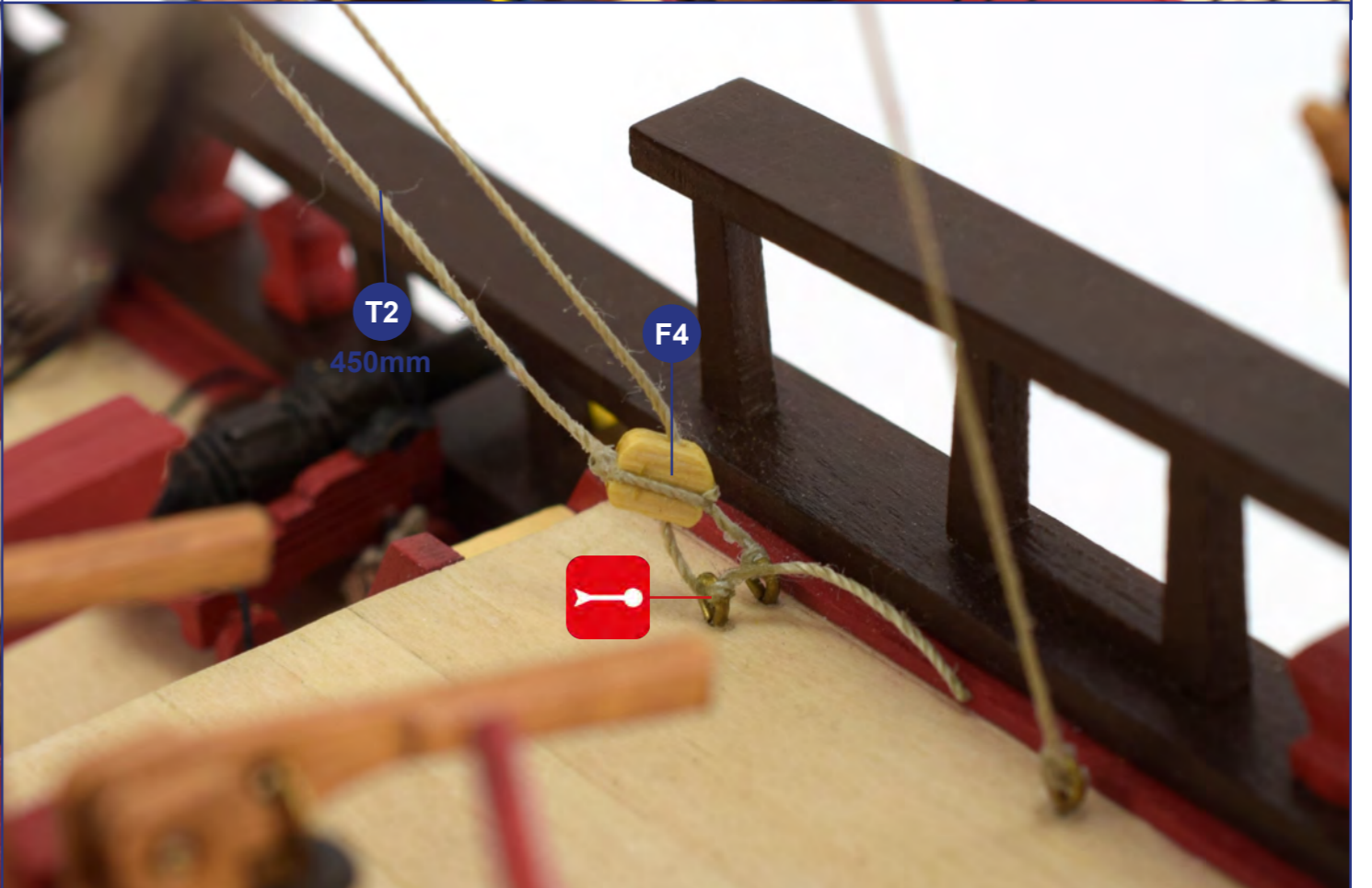





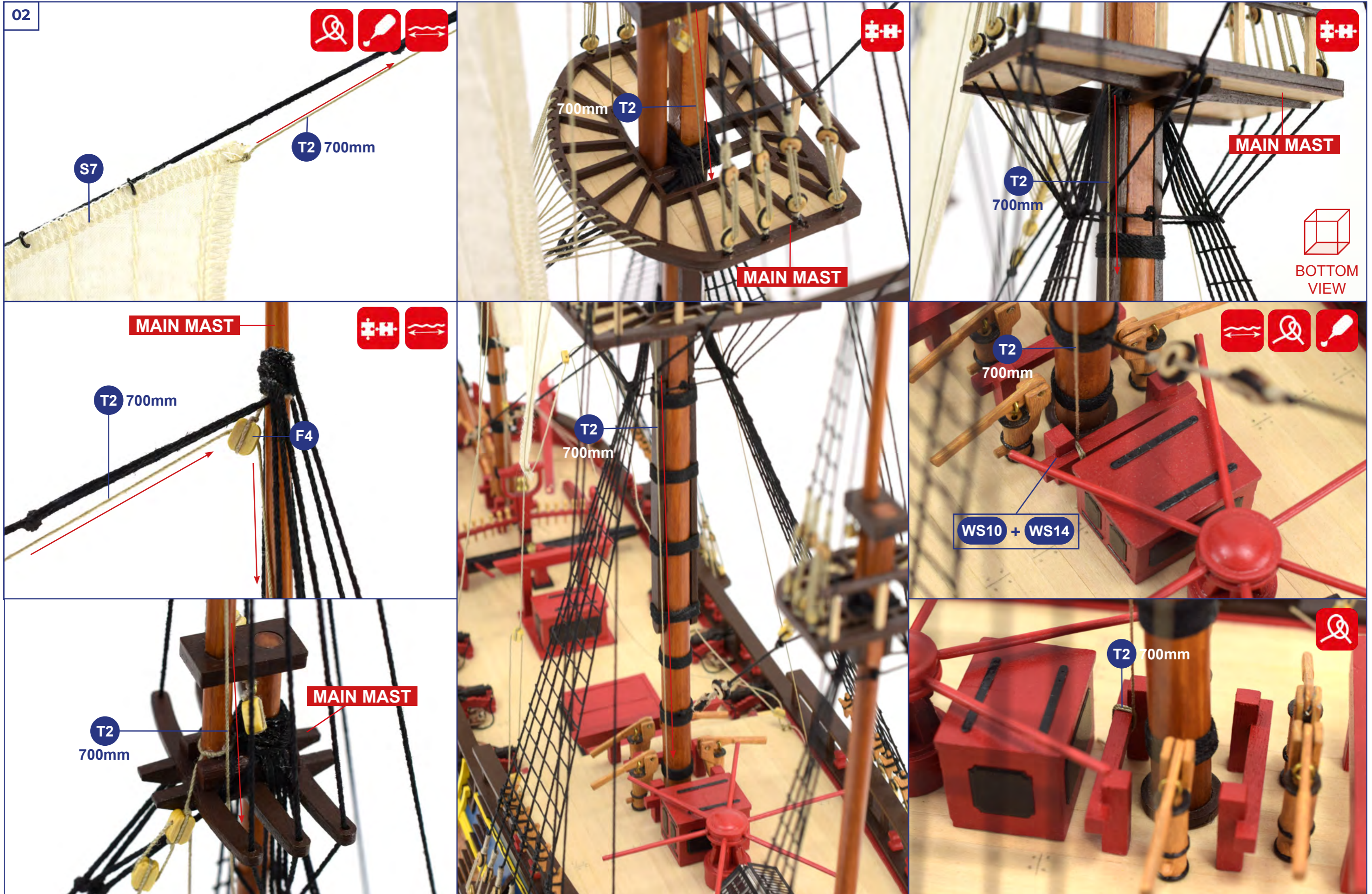

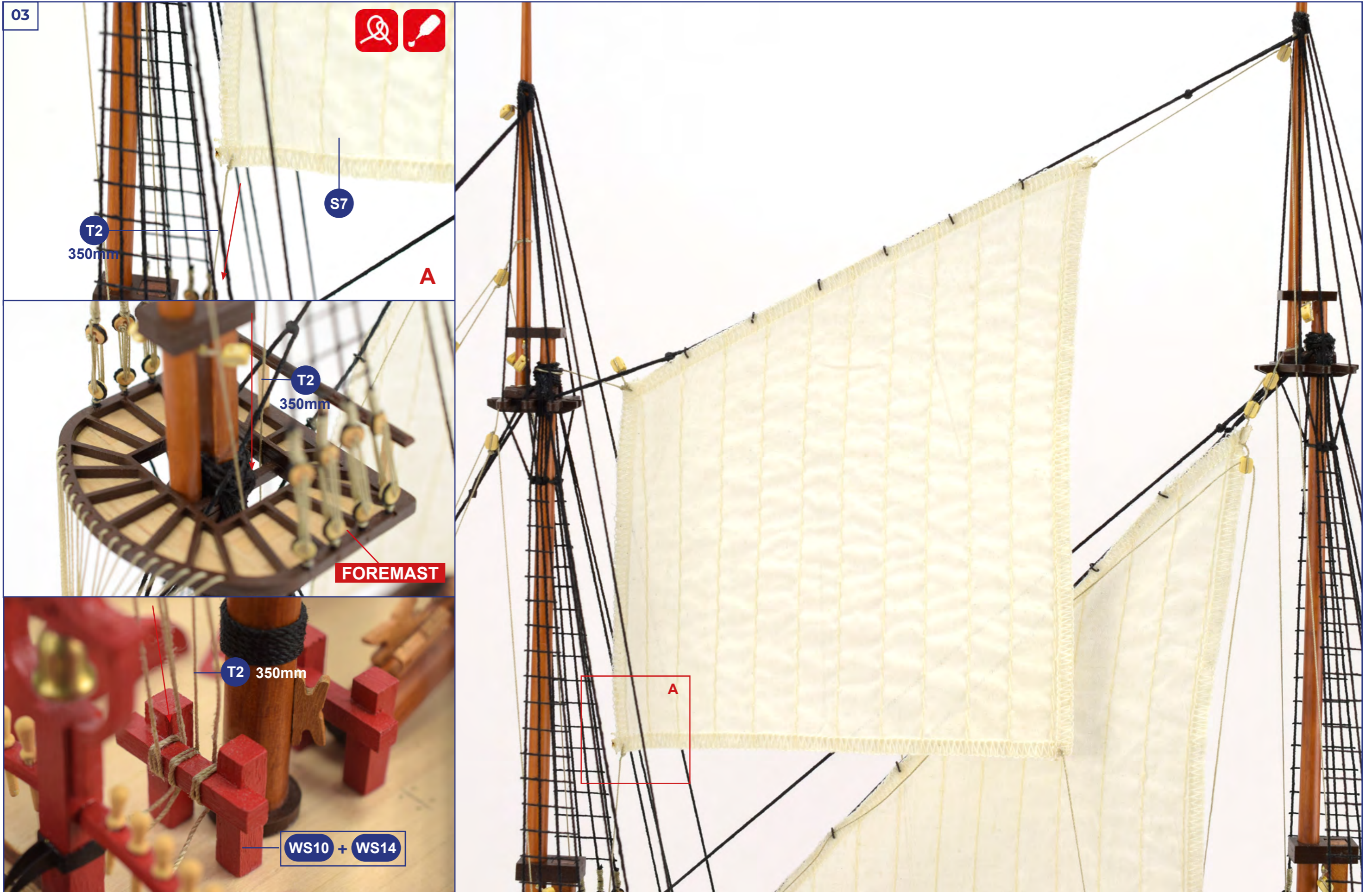

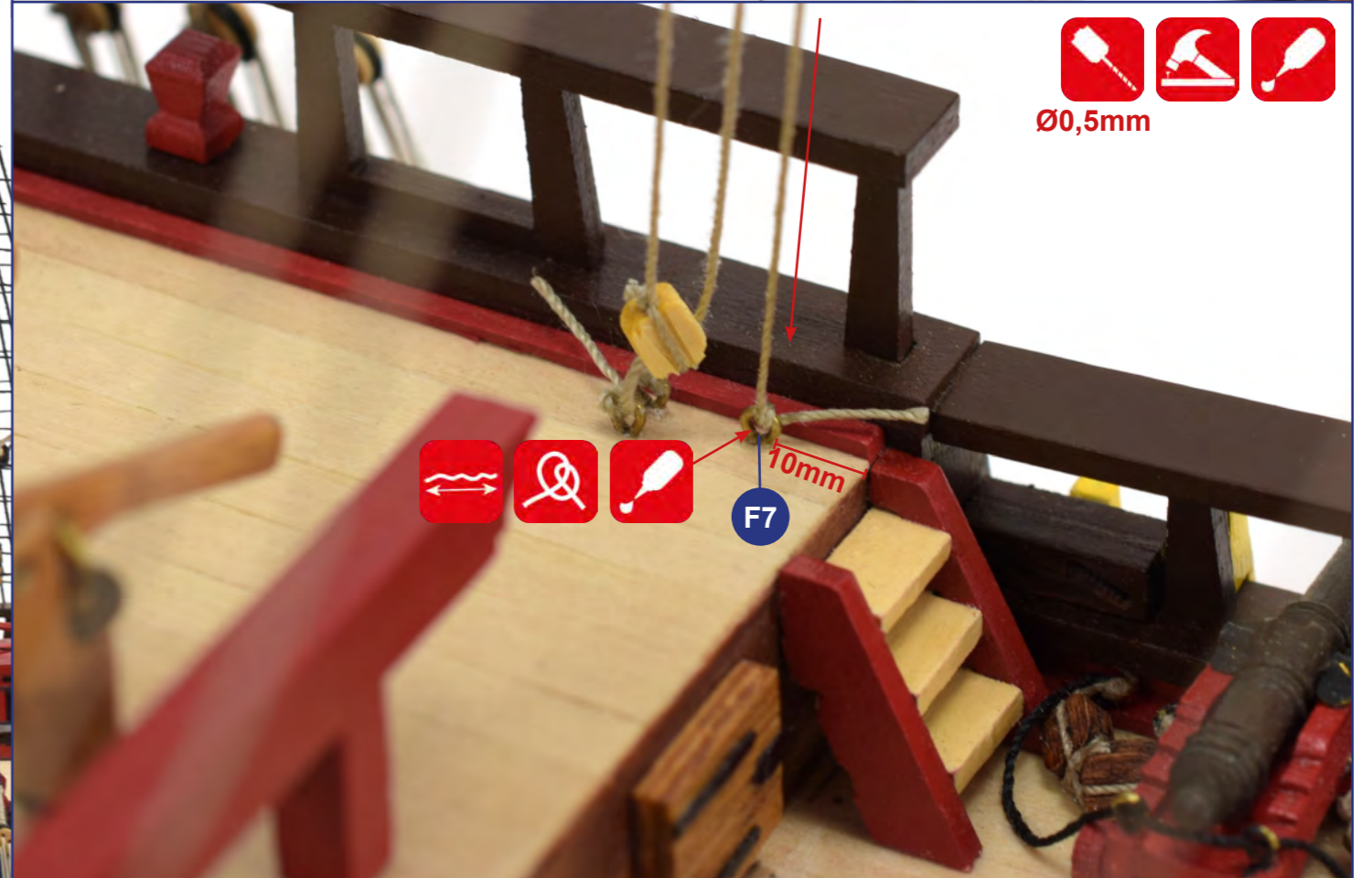
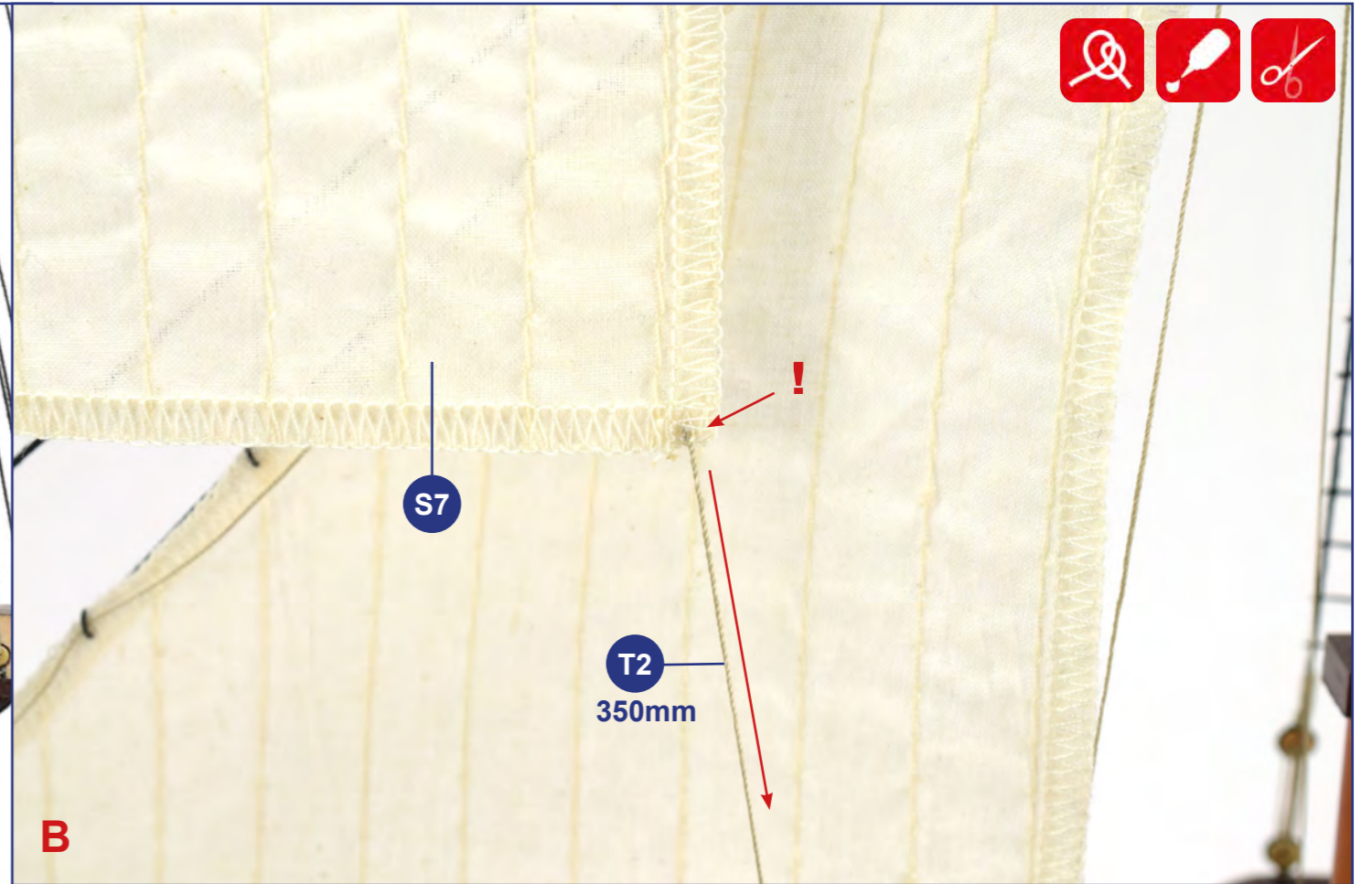
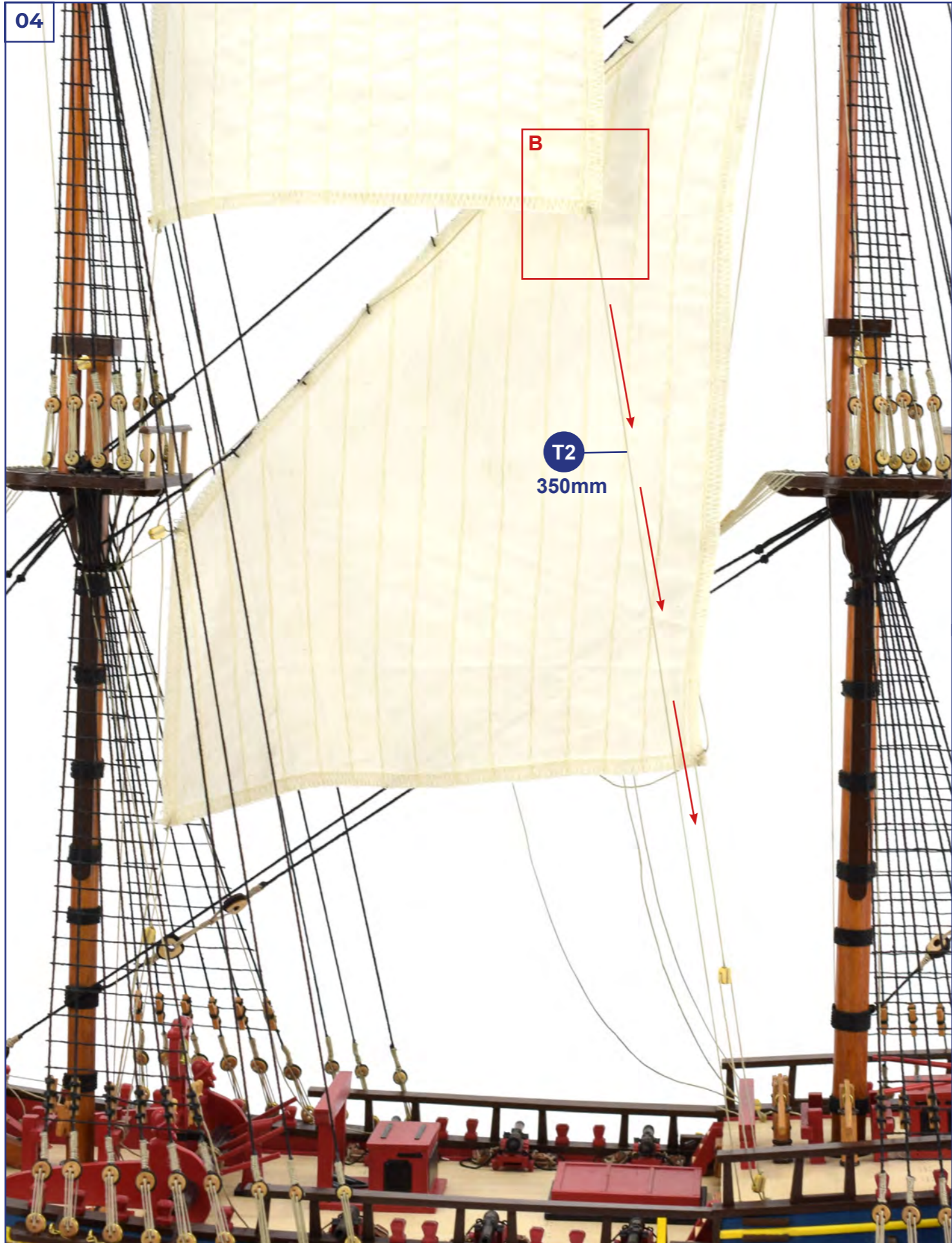

05

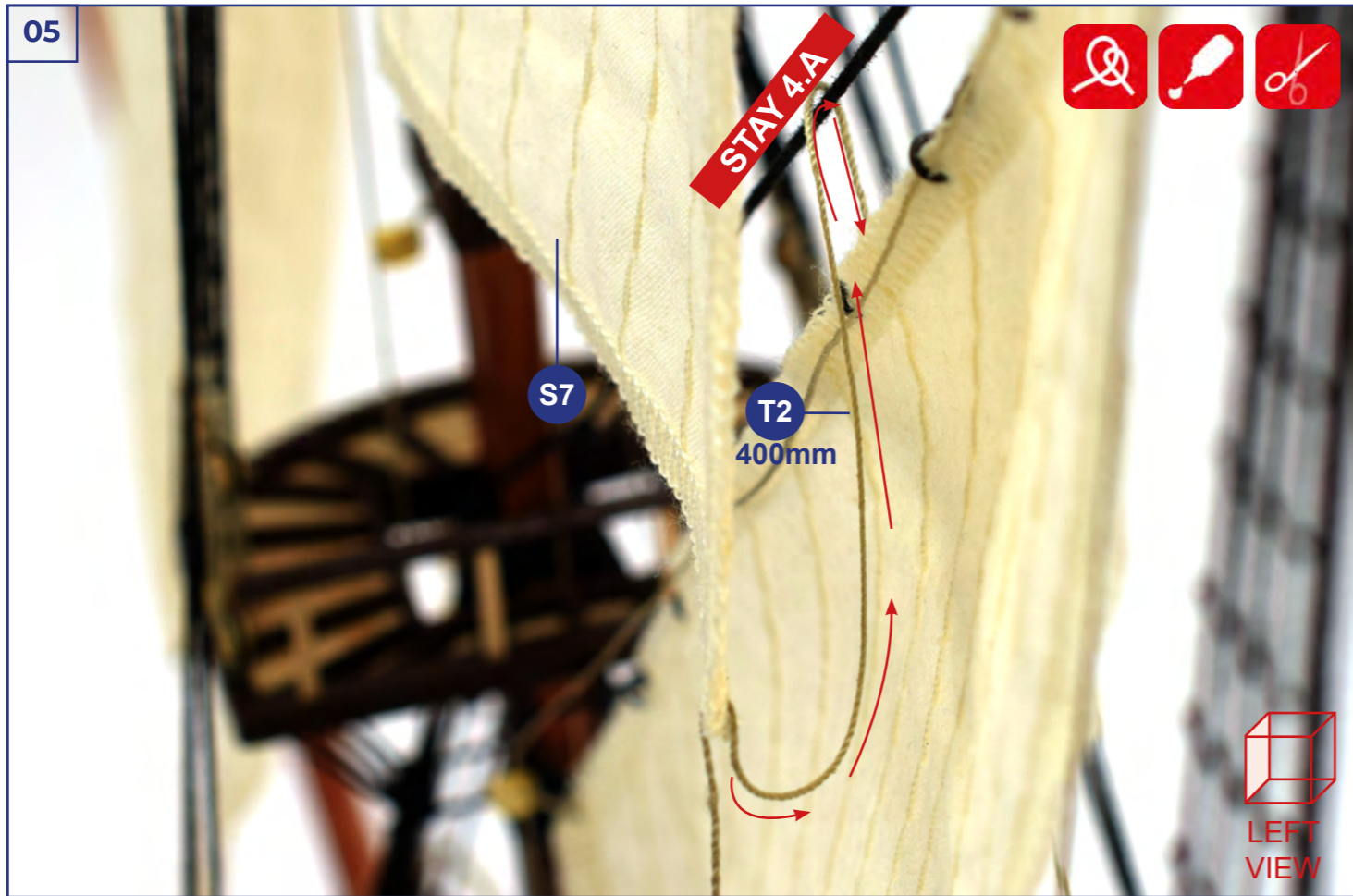

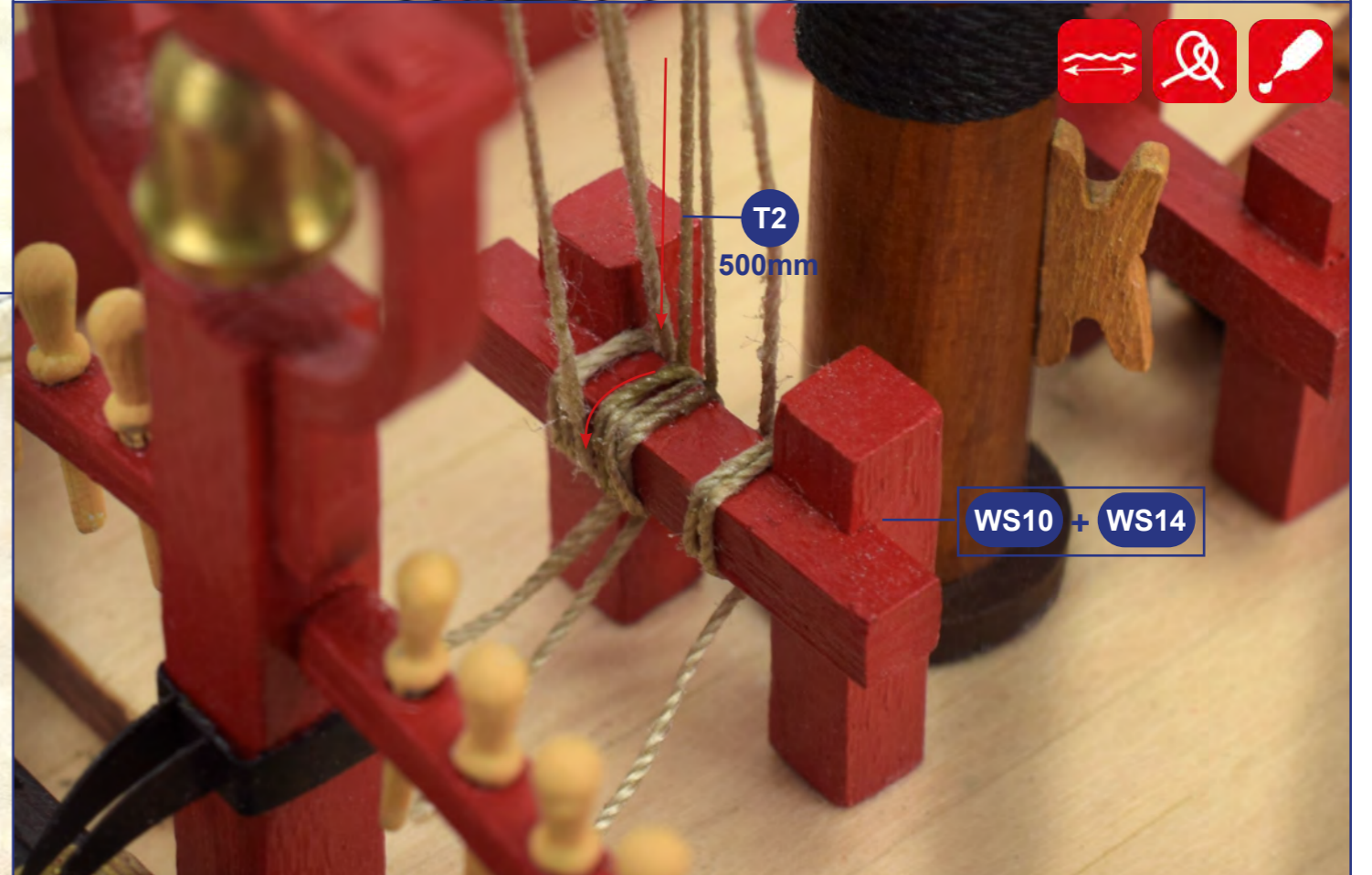
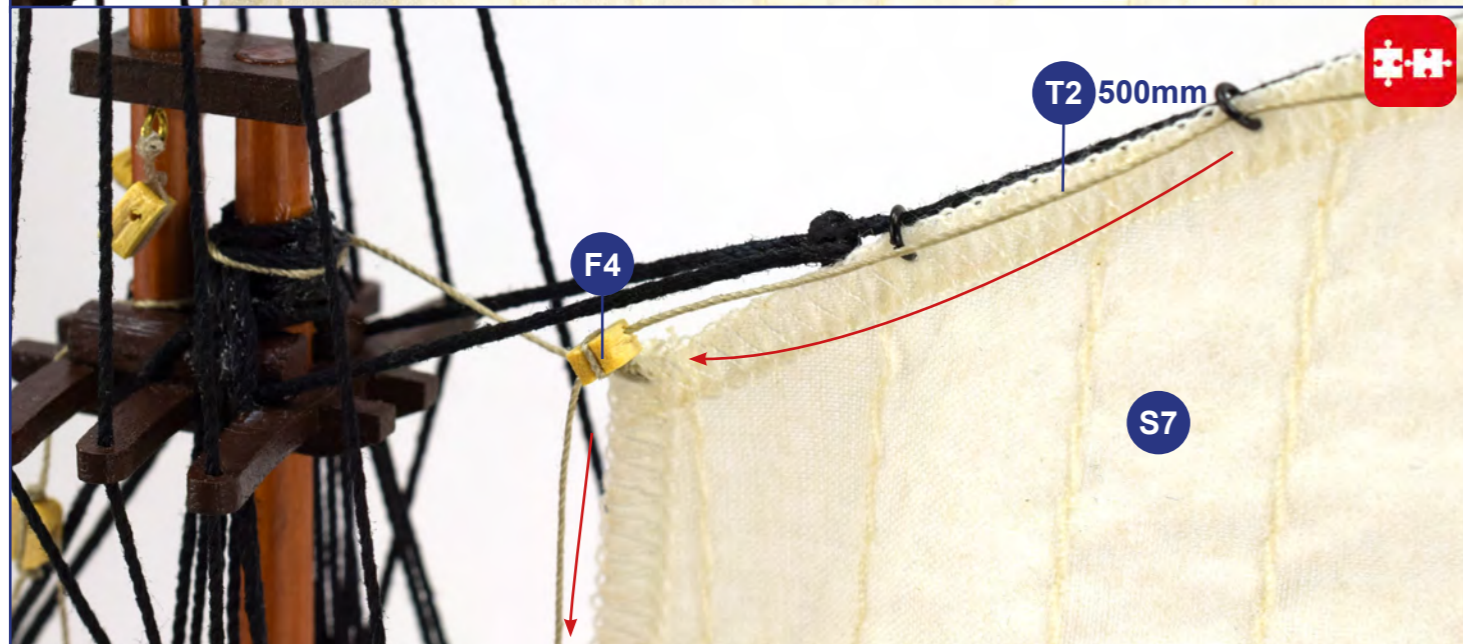
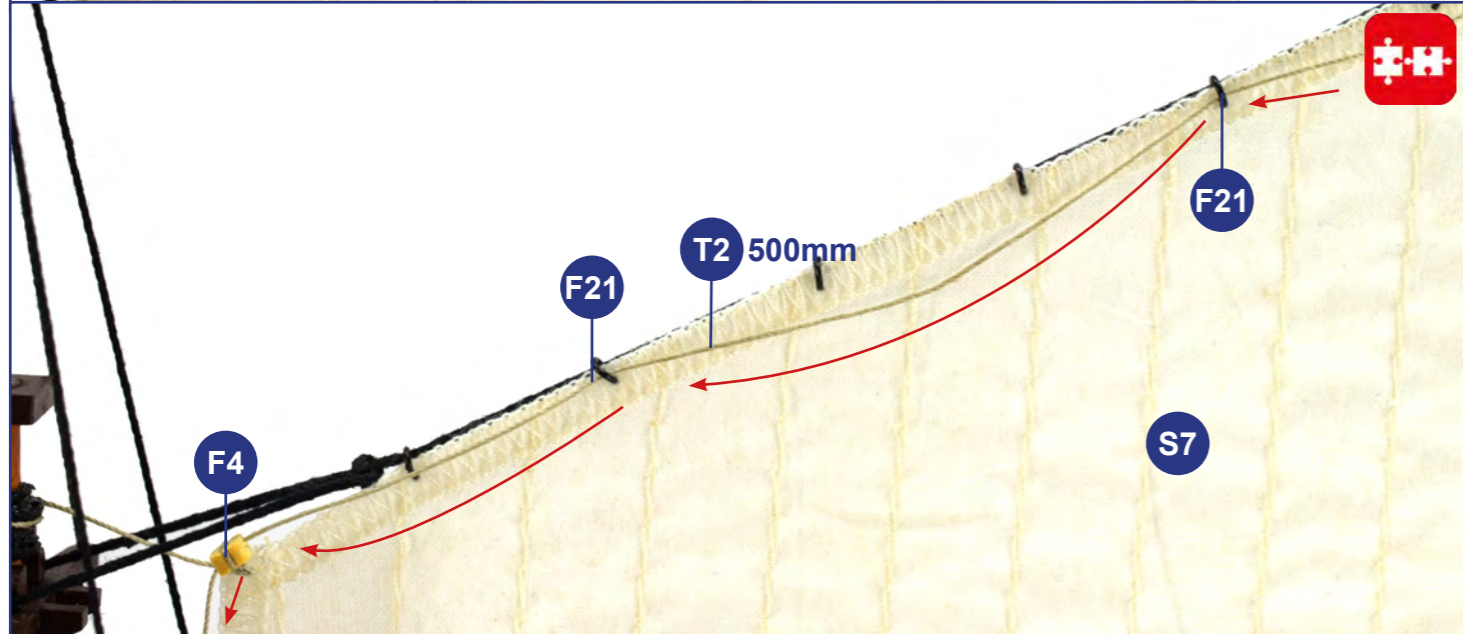
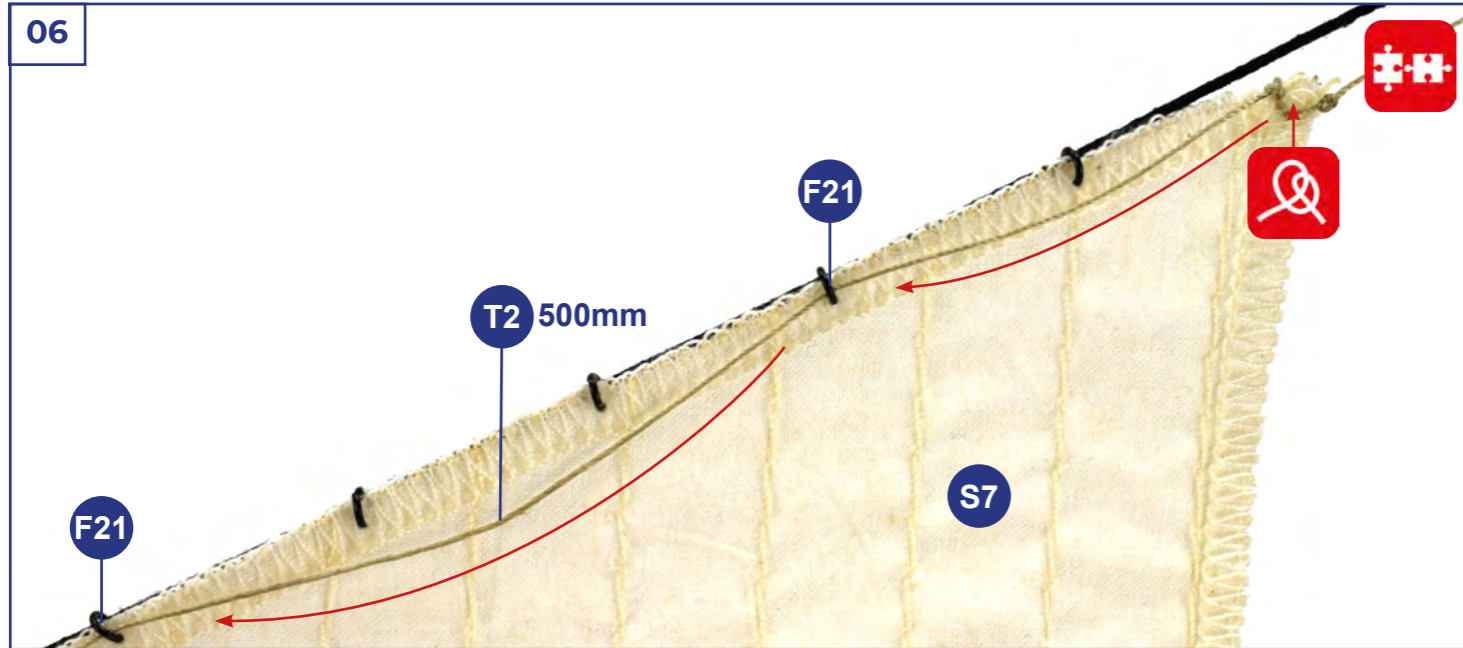



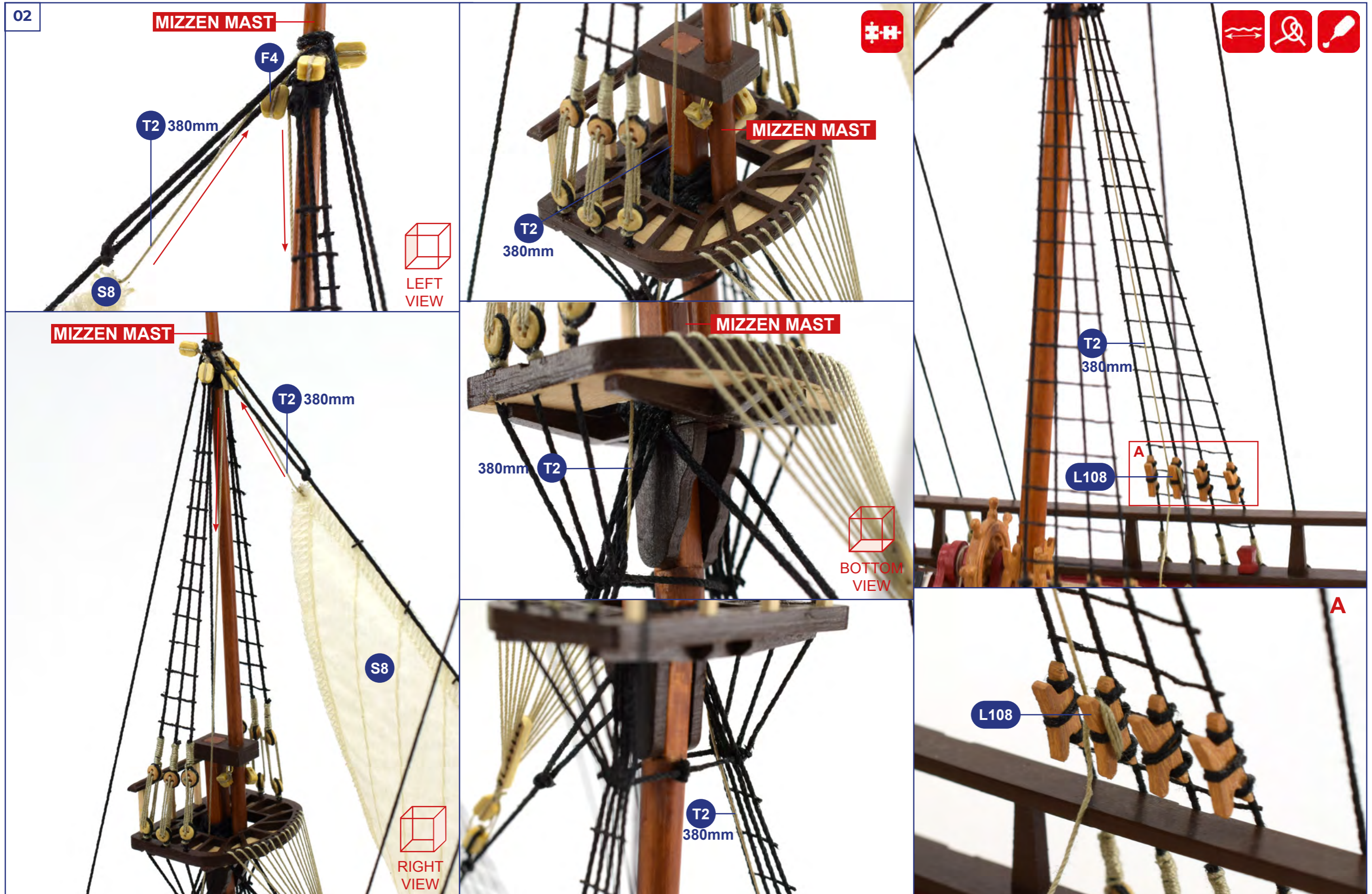

03

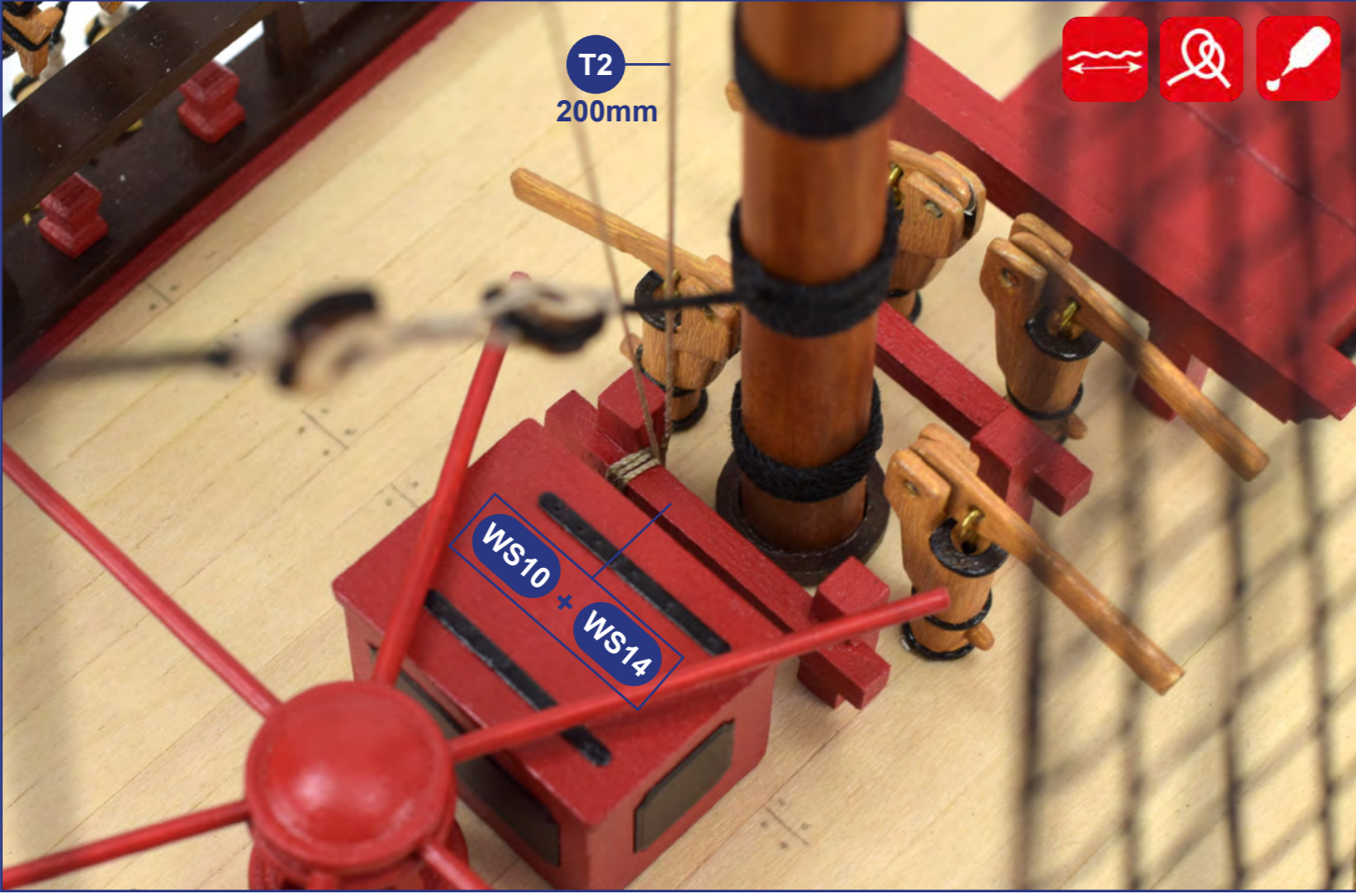
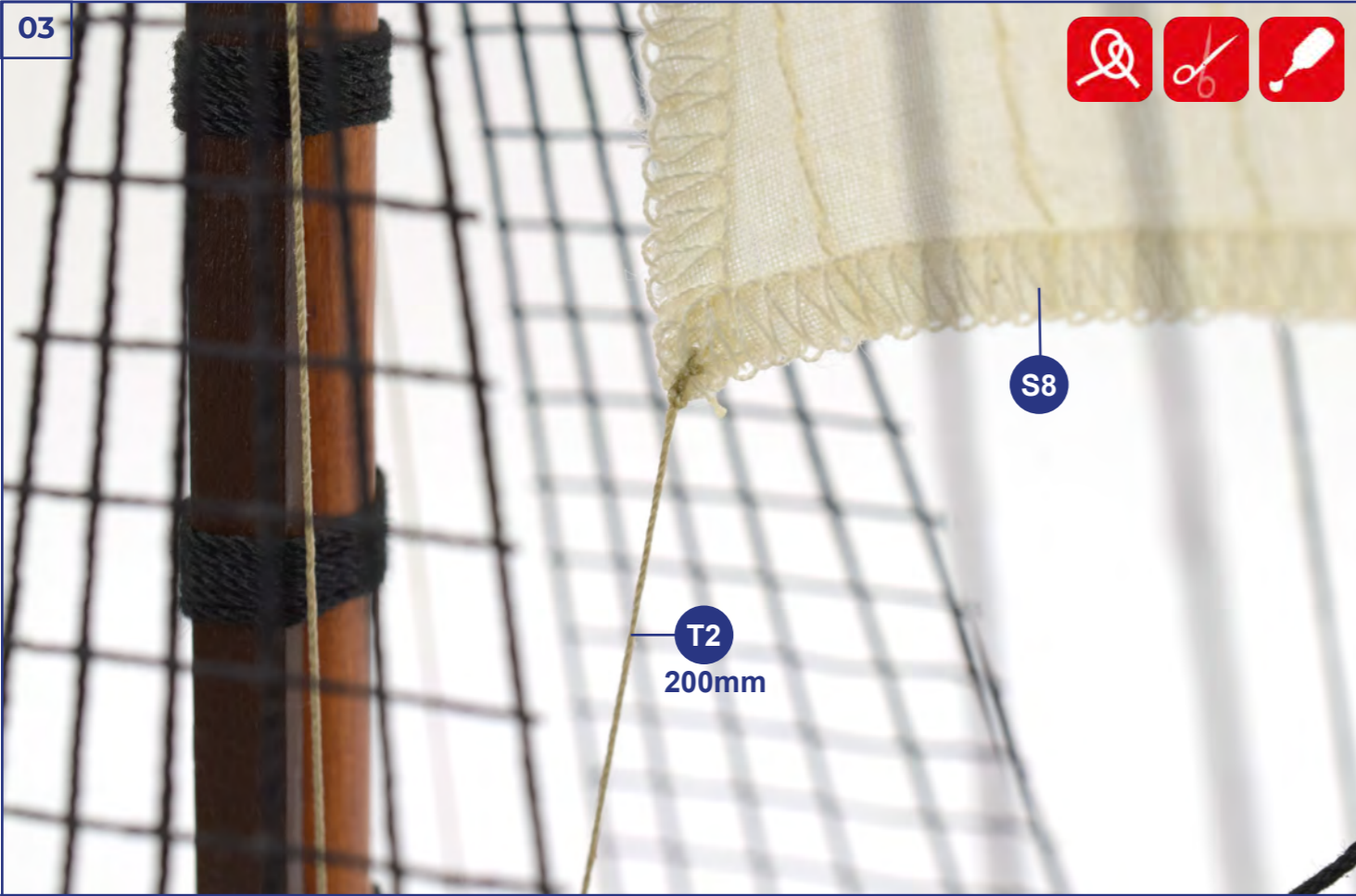

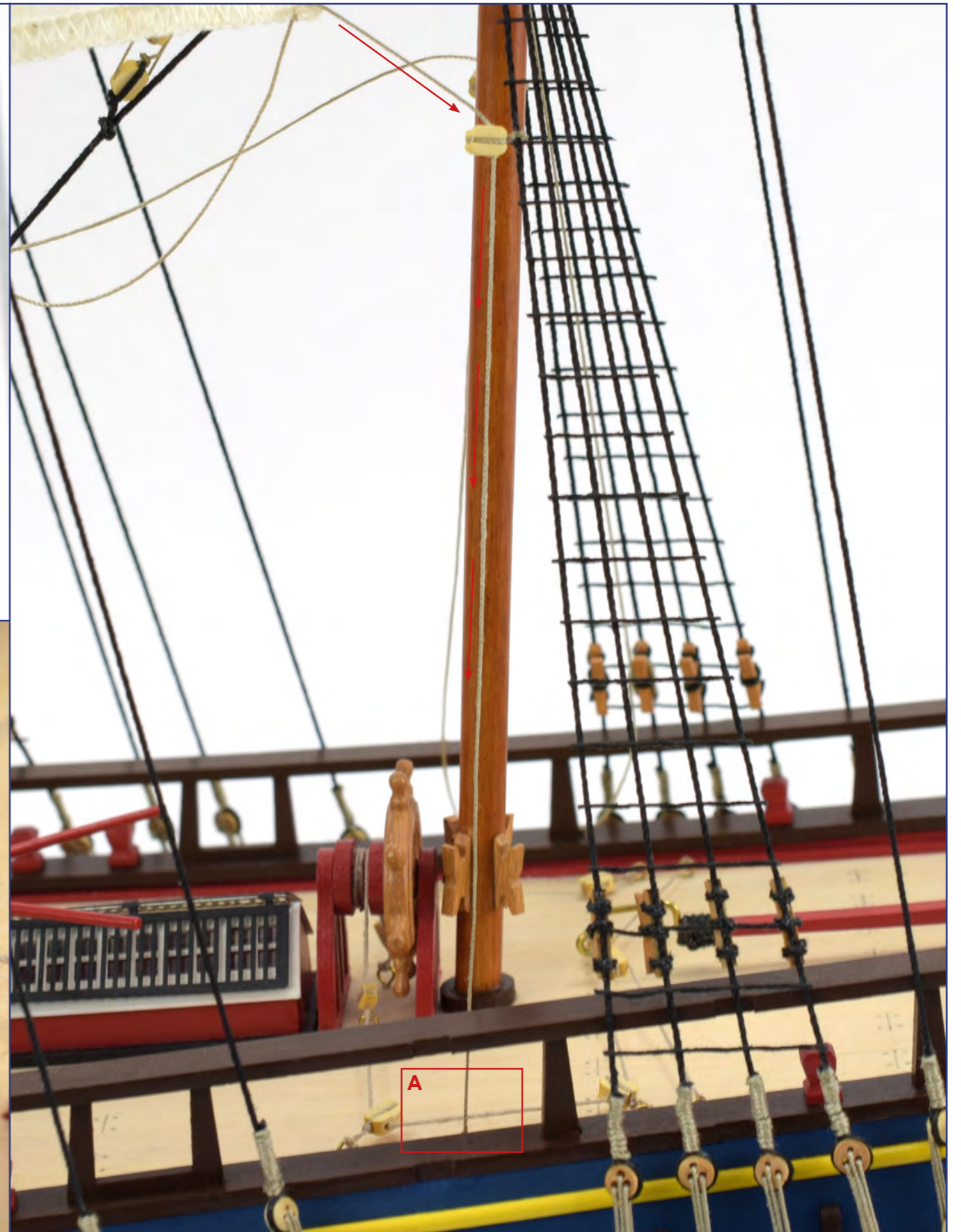
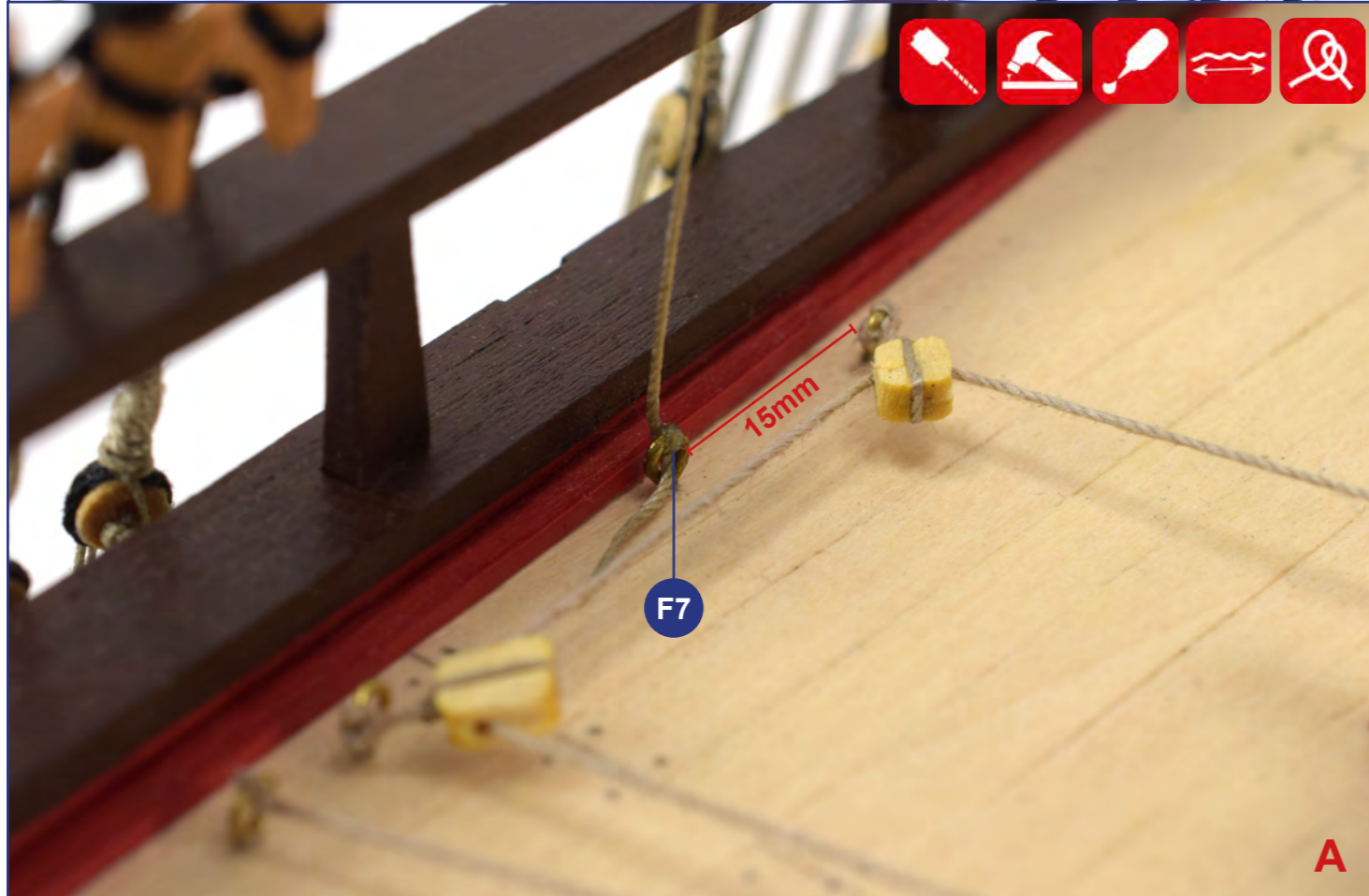
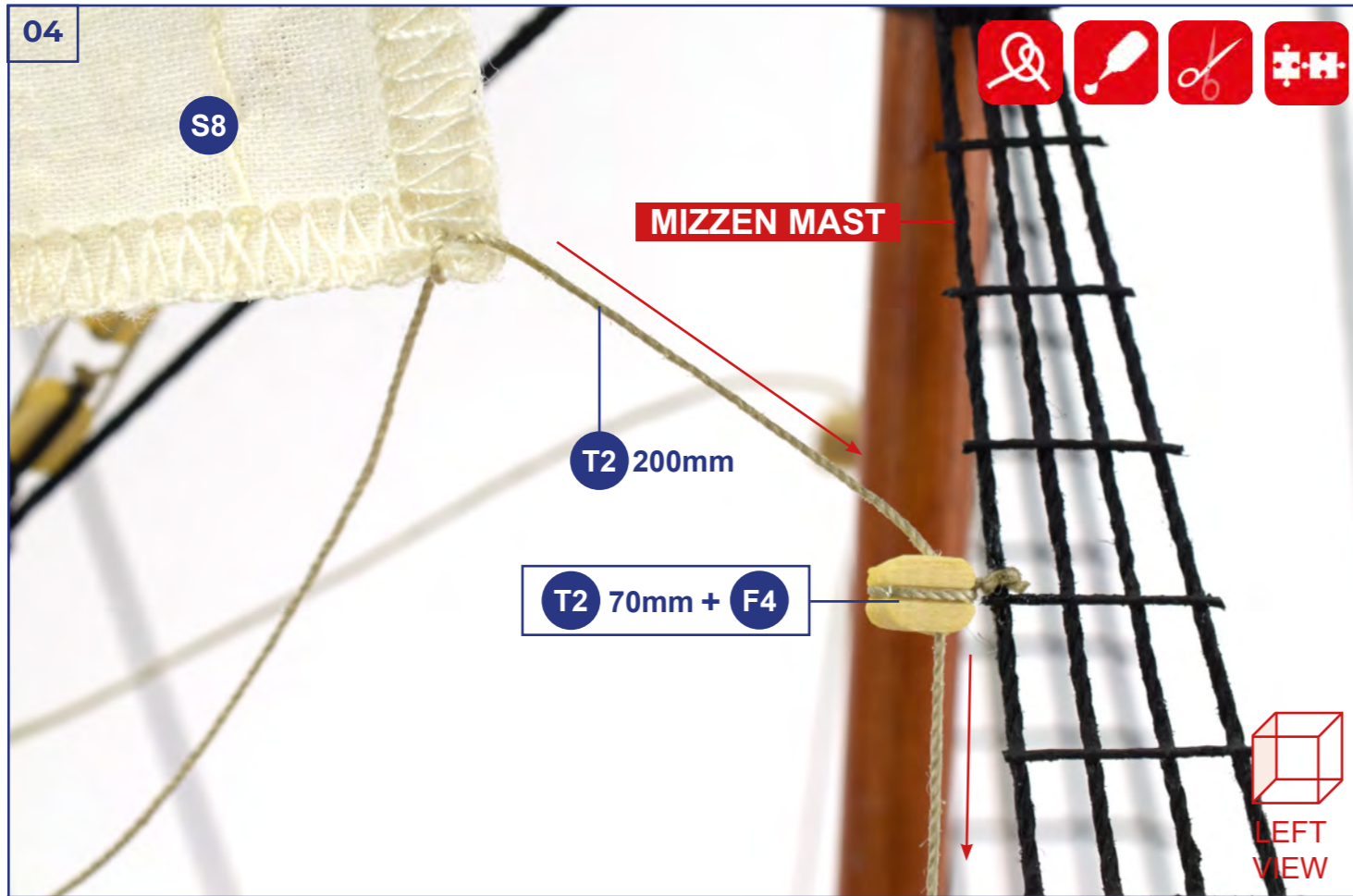

05

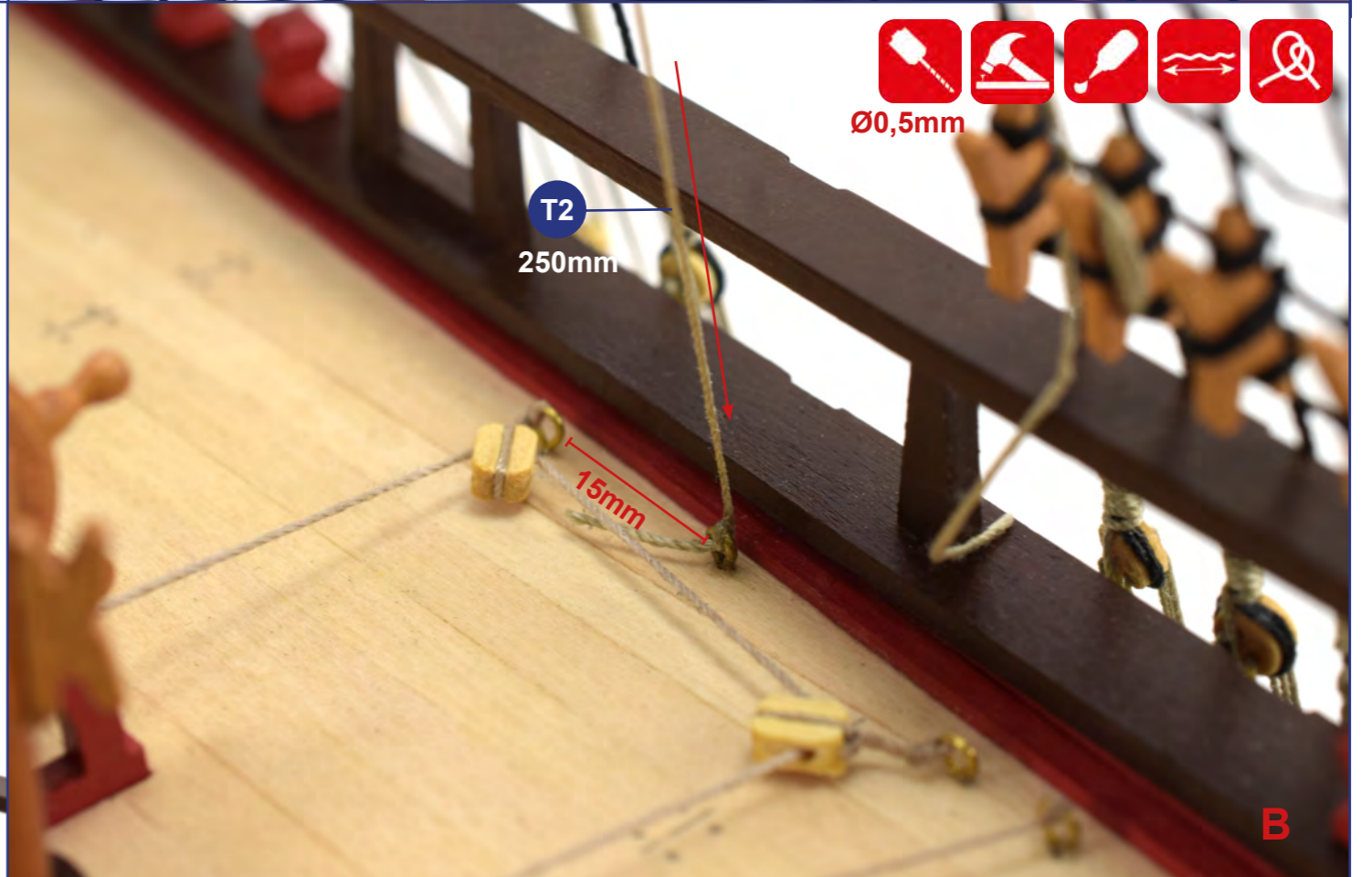
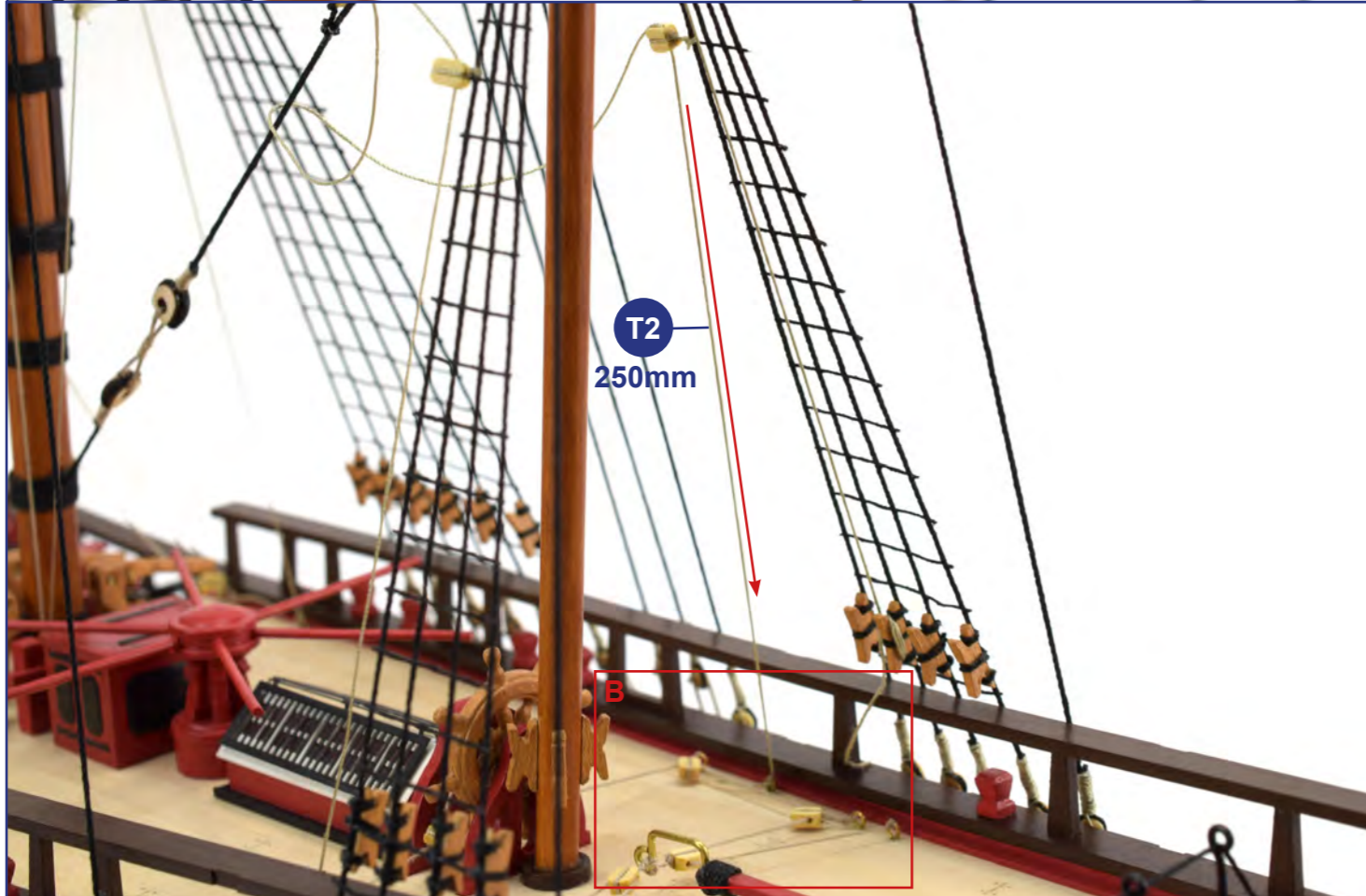
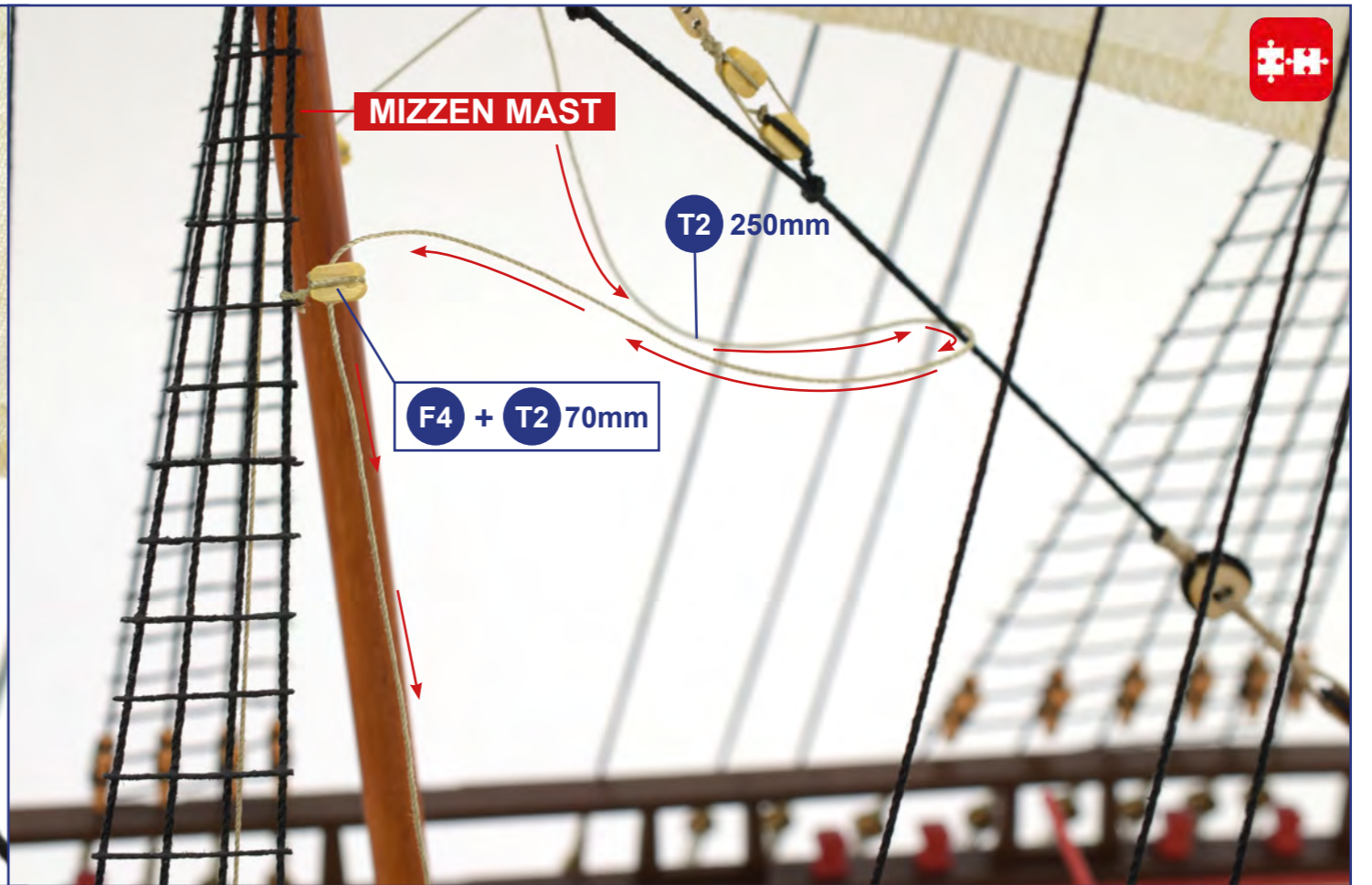
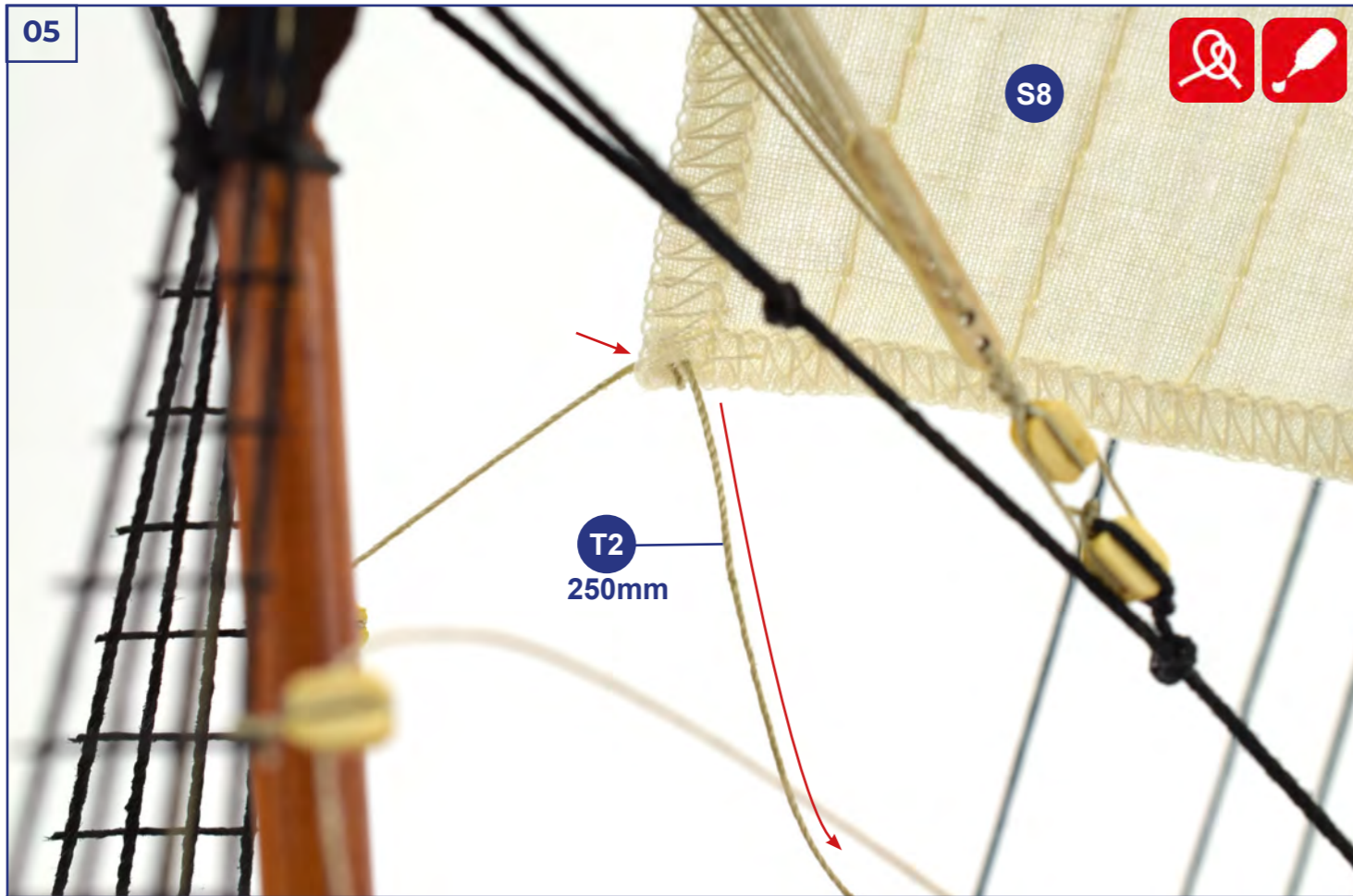

Ø0,5mm

06

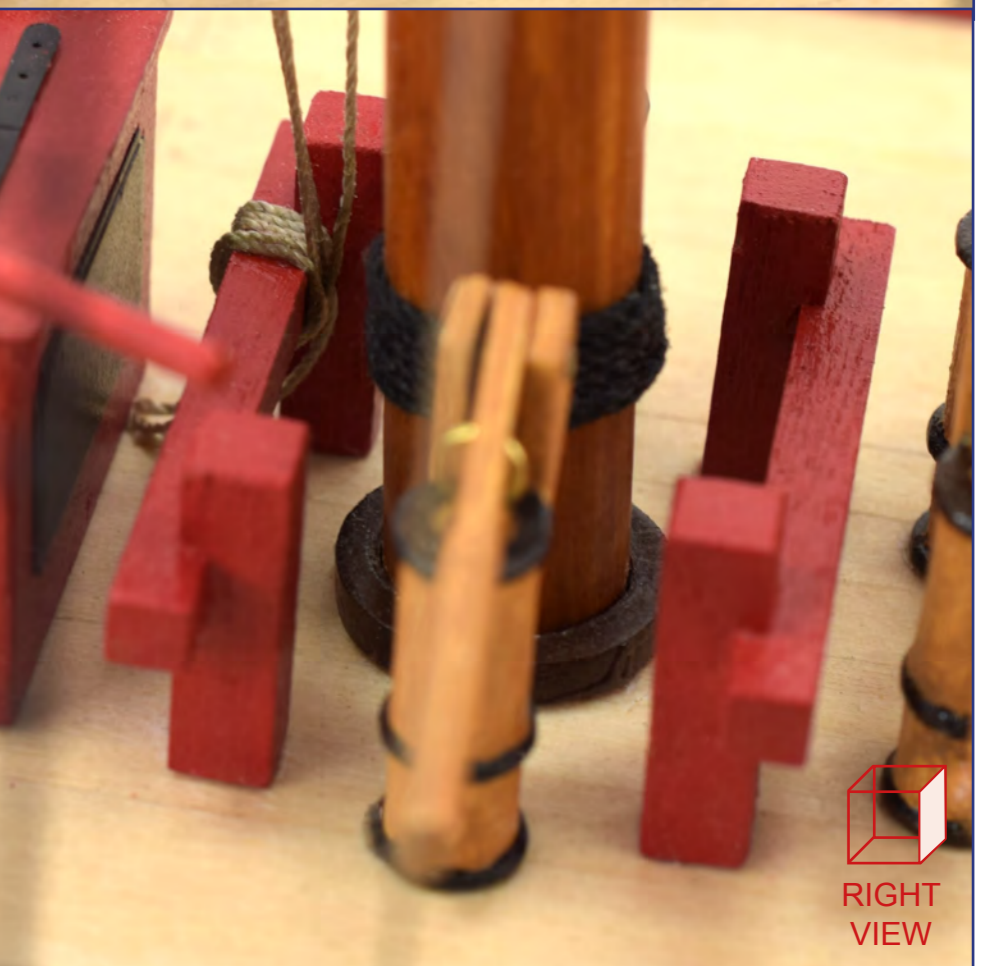
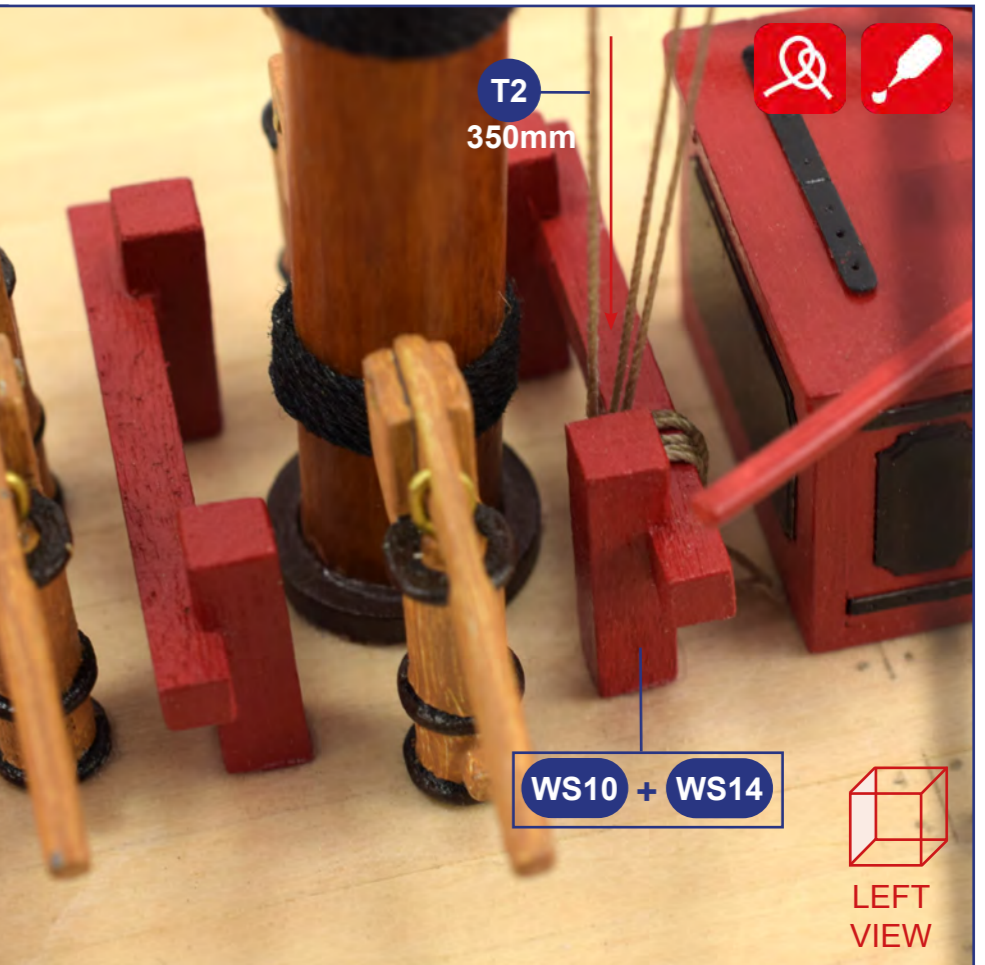
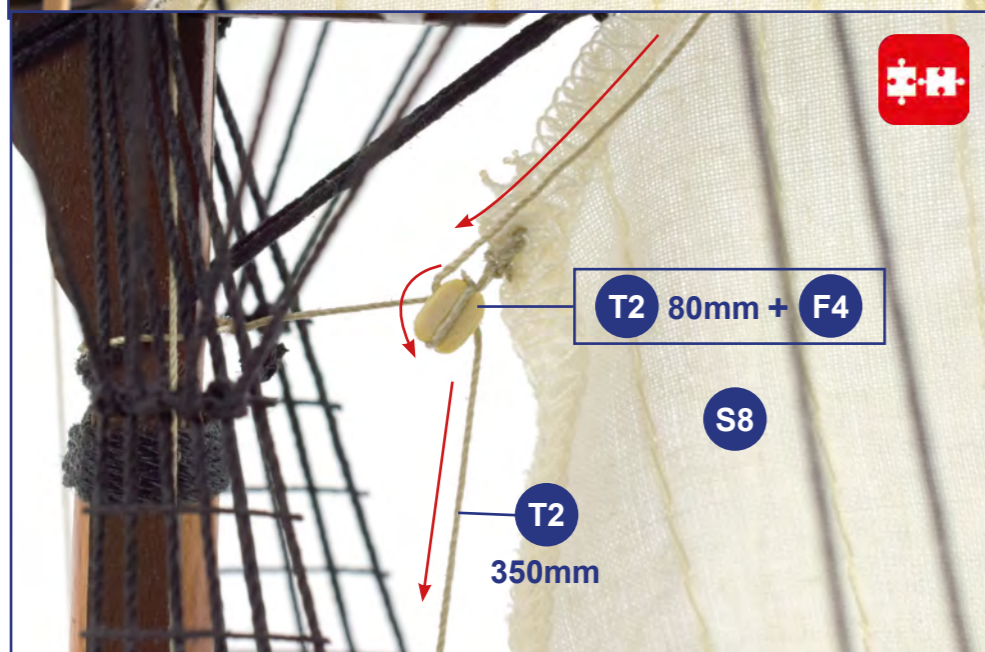
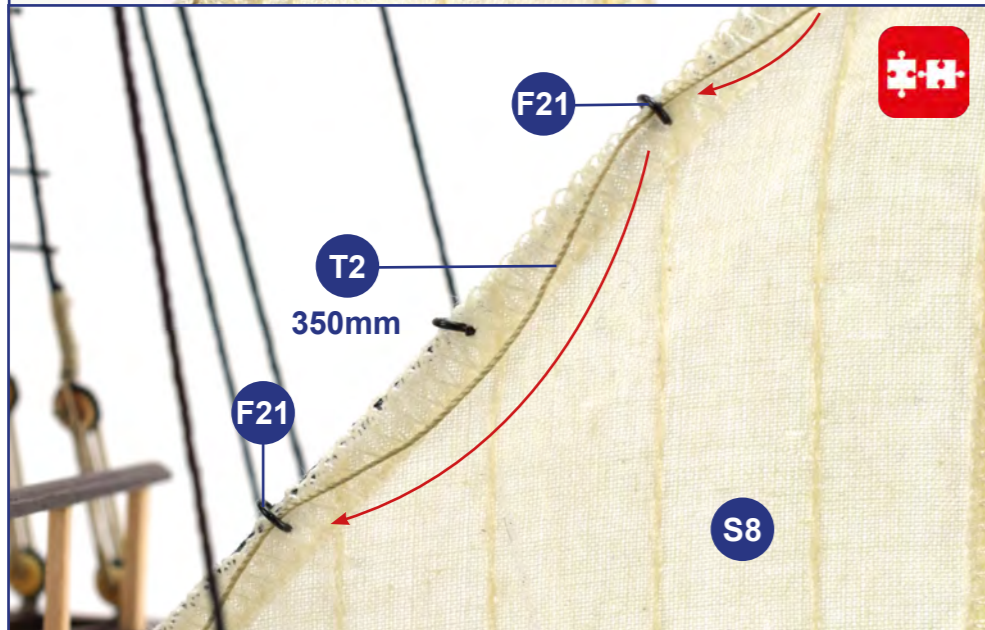
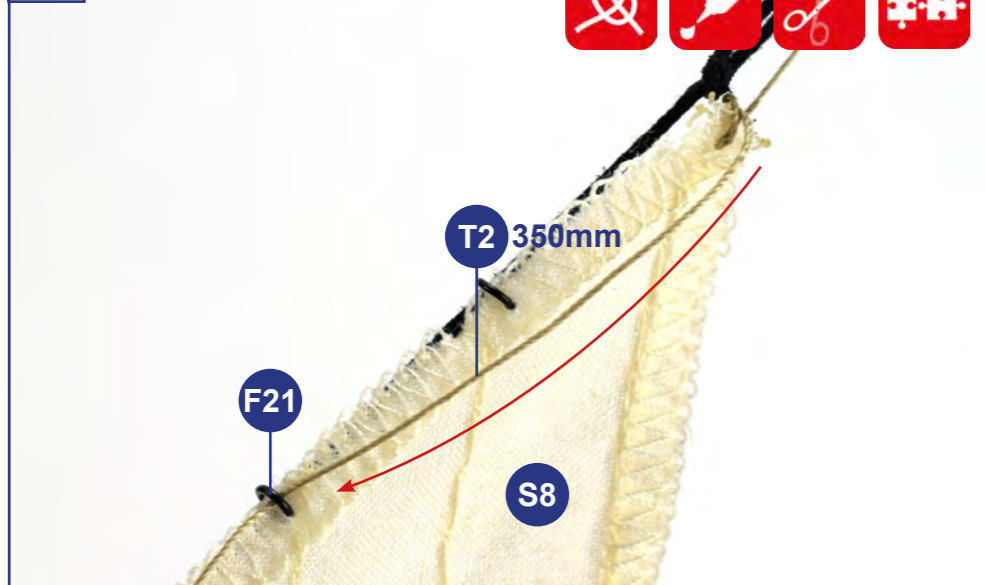

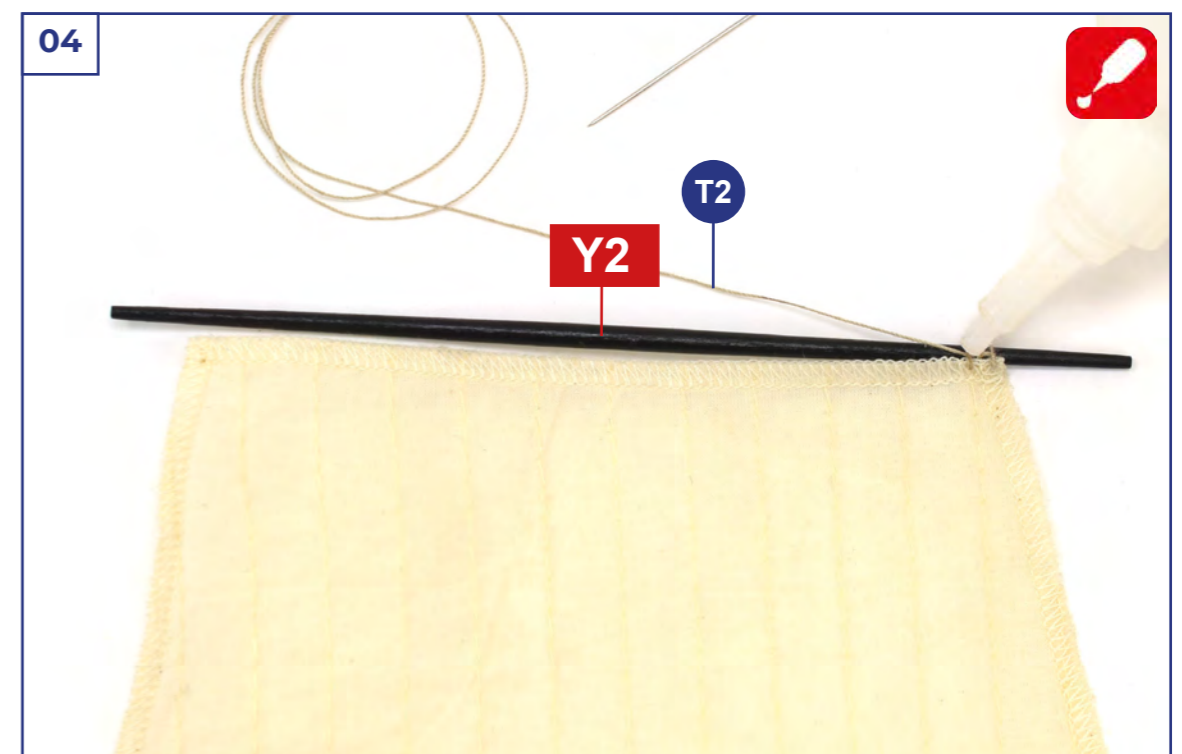
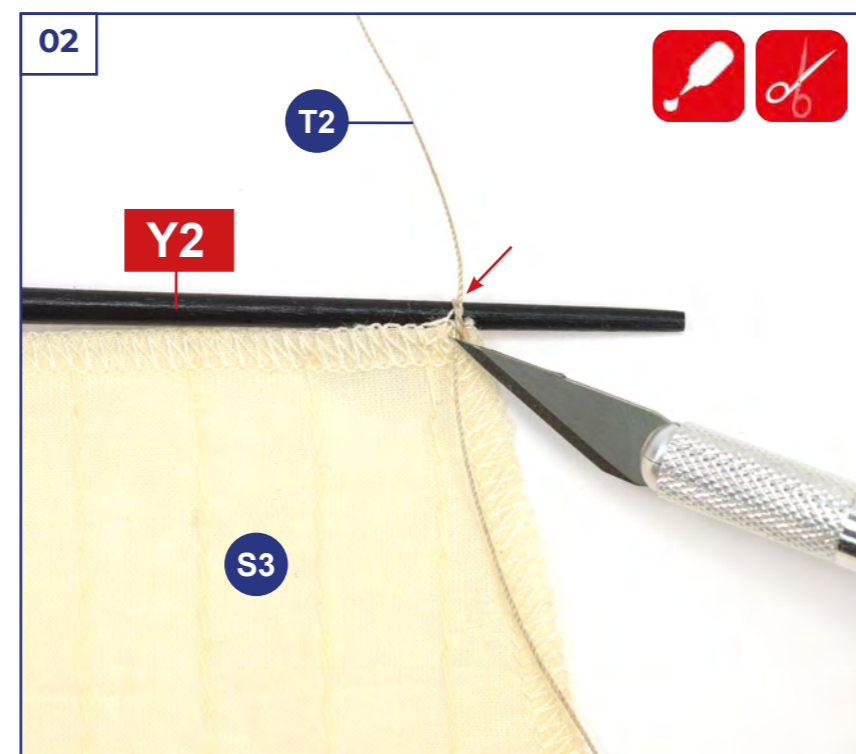
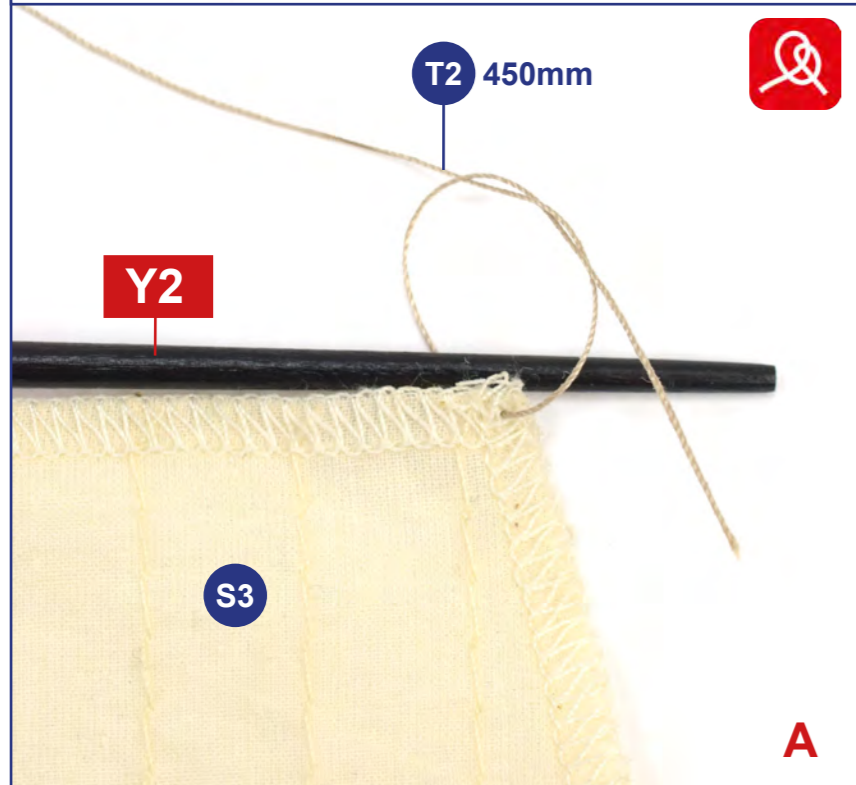
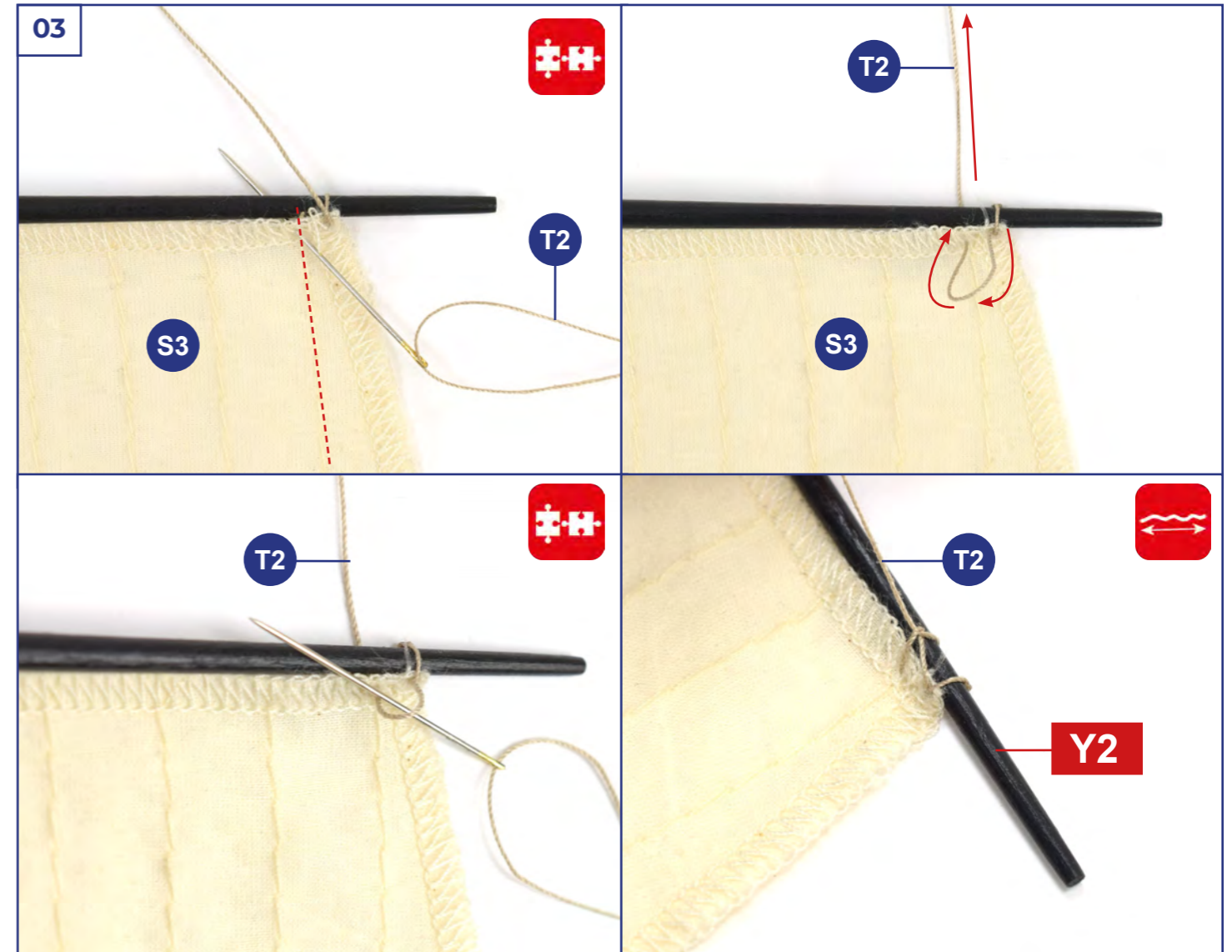
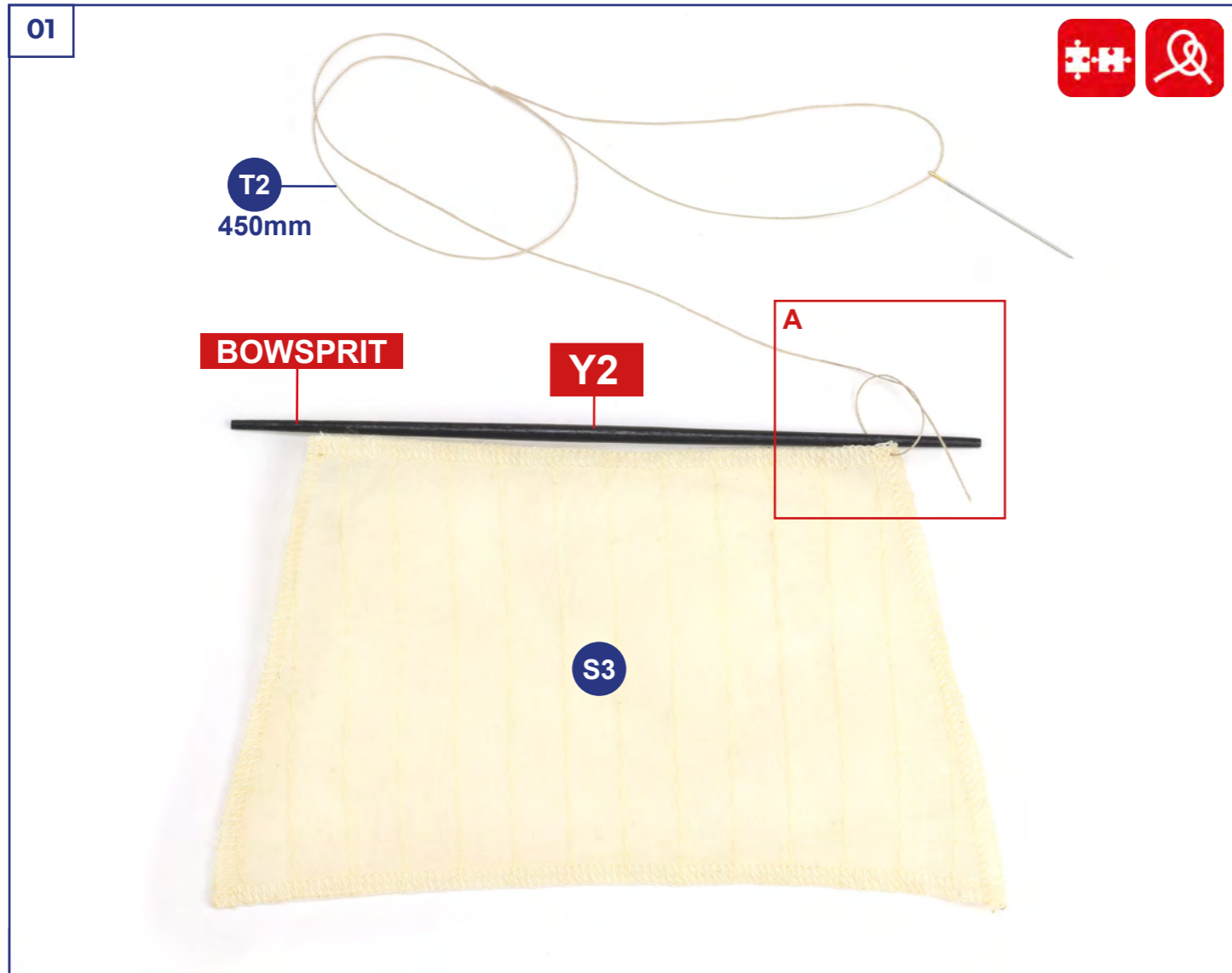

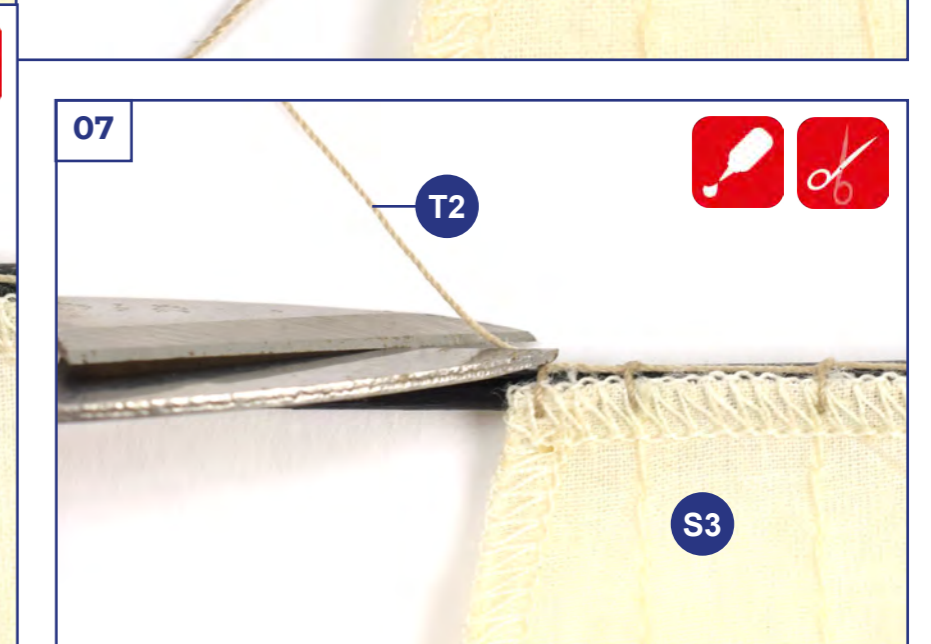
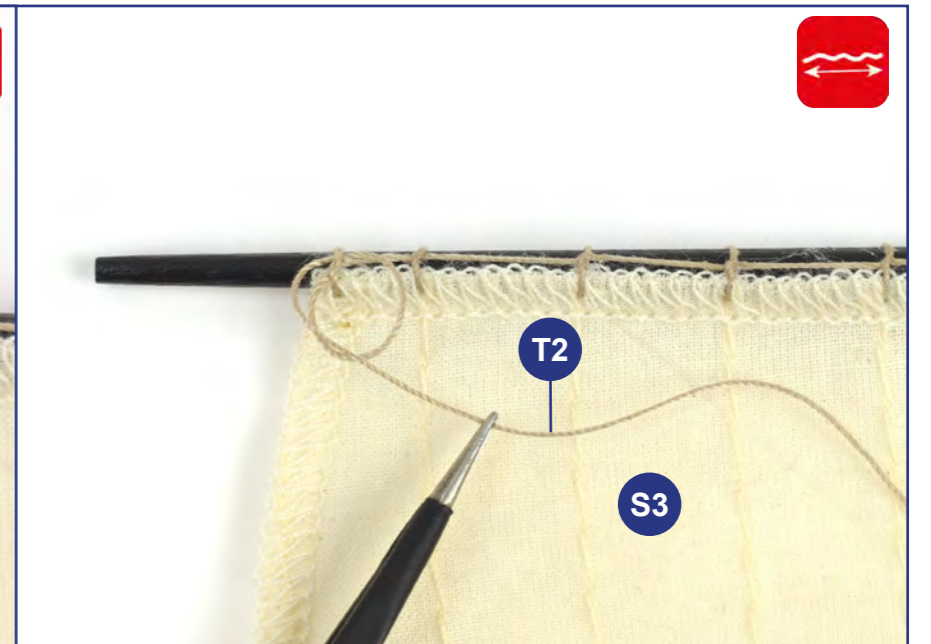
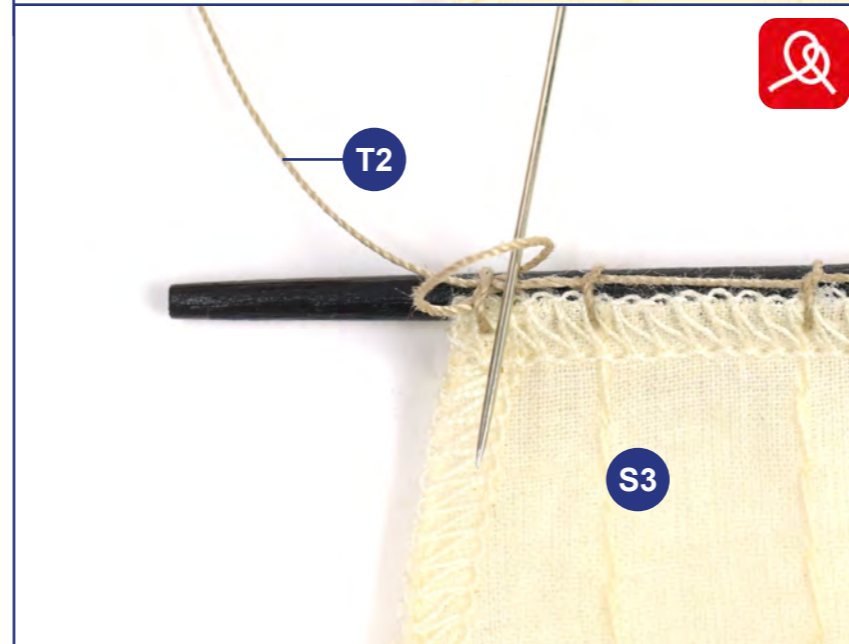
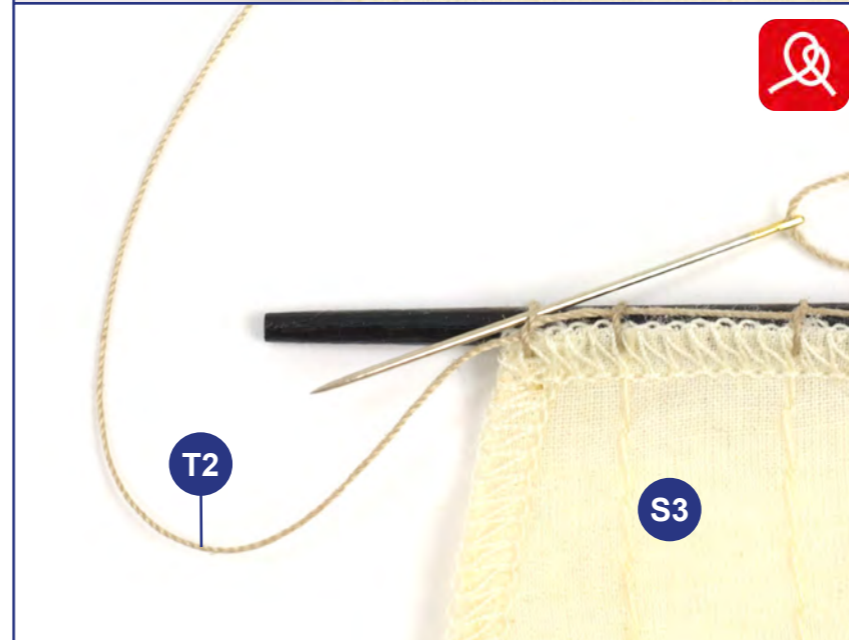
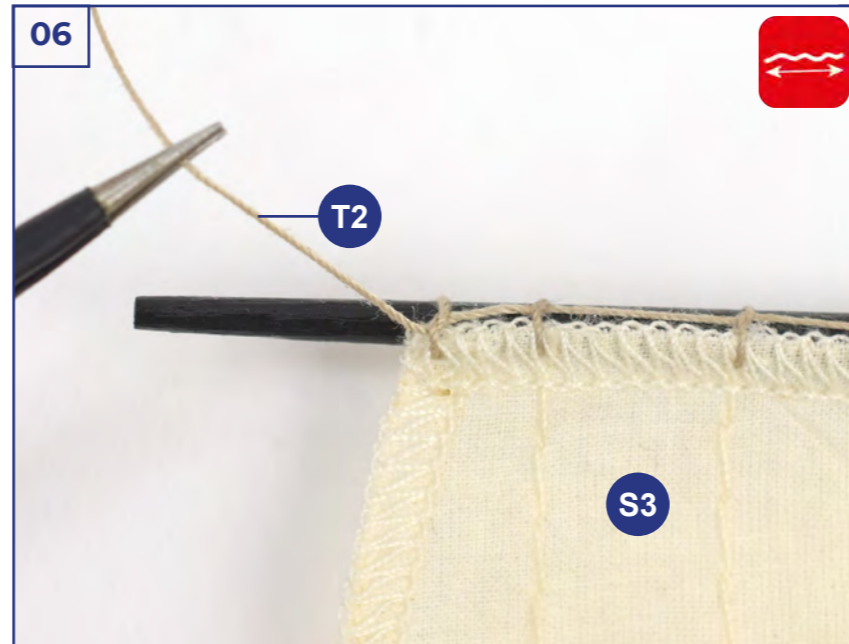
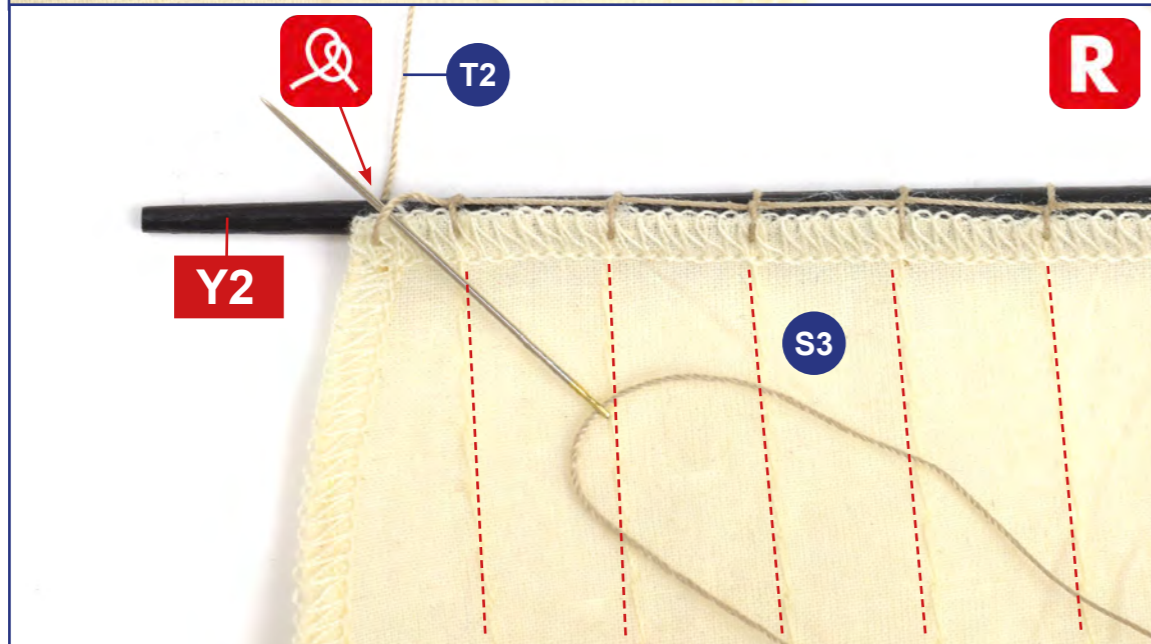
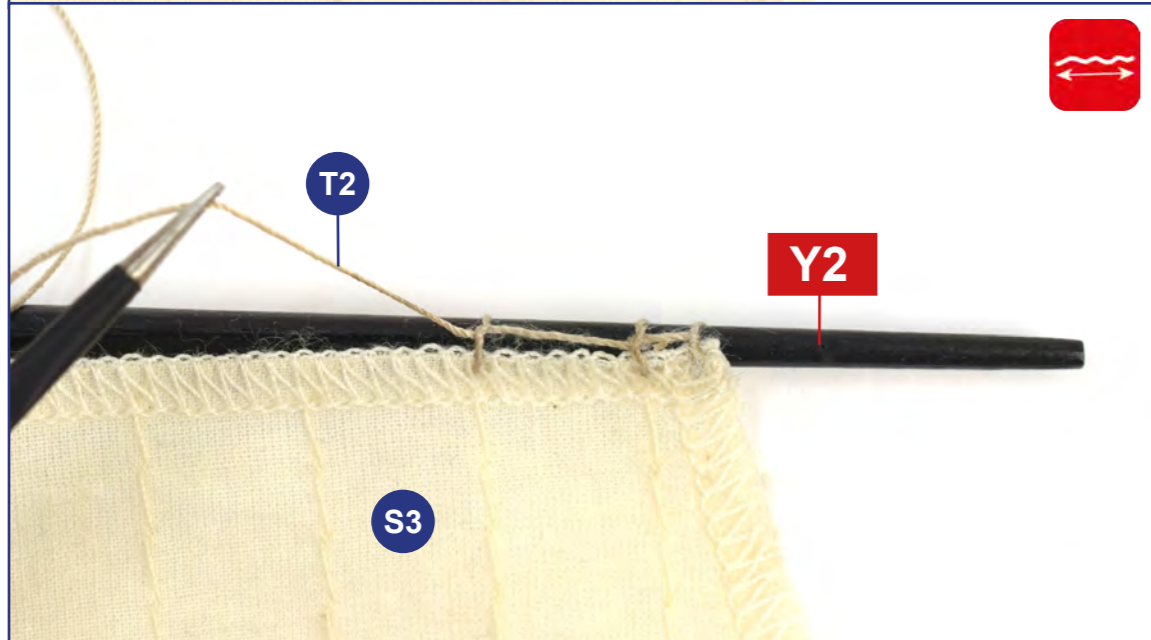
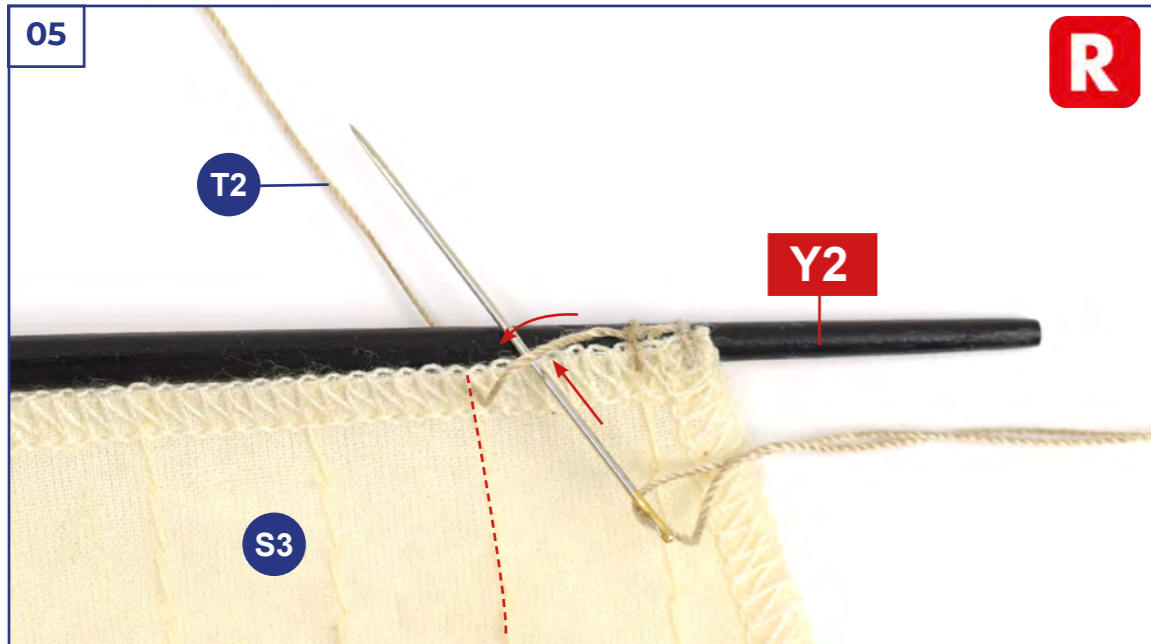

08

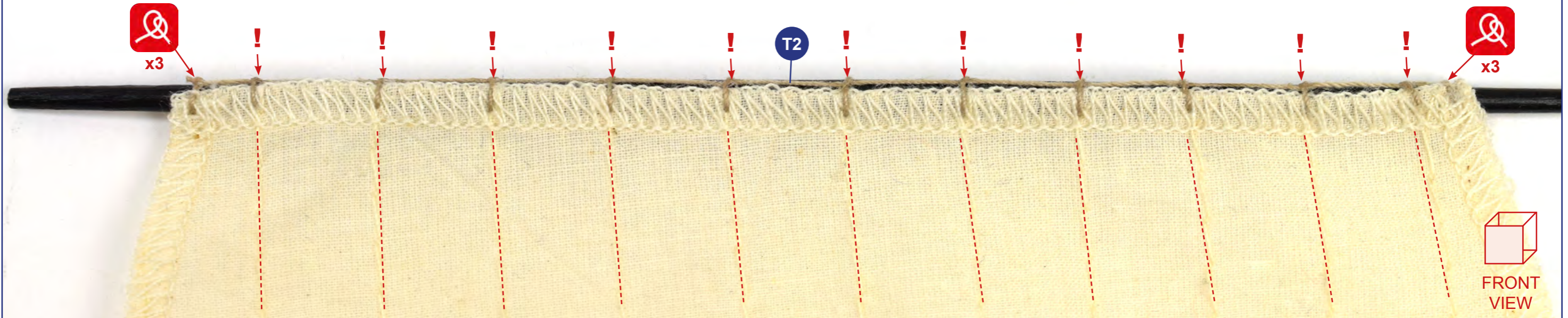

BOWSPRIT

S3 + T2 450mm - Y2
S4 + T2 600mm - Y1

FOREMAST

S9 + T2 600mm - Y5
S10 + T2 600mm - Y6
S11 + T2 450mm - Y7

MAIN MAST

S12 + T2 700mm - Y8
S13 + T2 500mm - Y9
S14 + T2 450mm - Y10

MIZZEN MAST

S5 + T2 500mm - Y4
S15 + T2 500mm - Y11



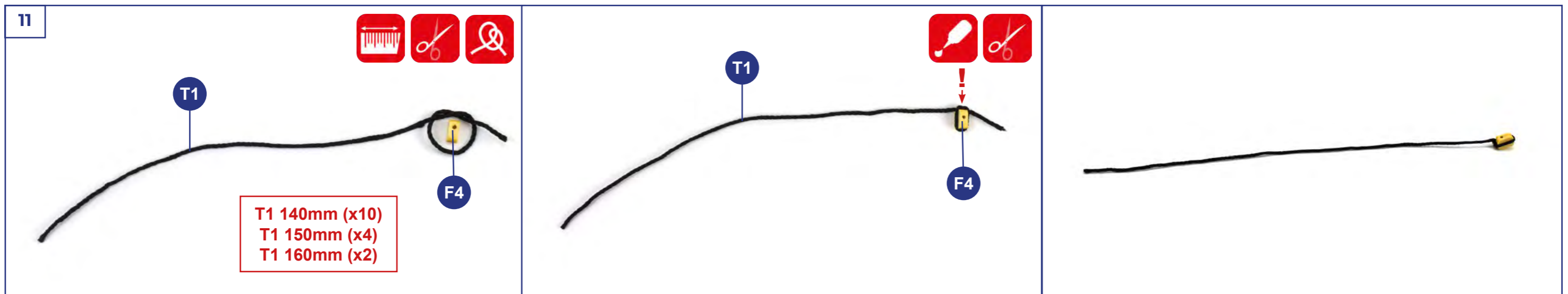
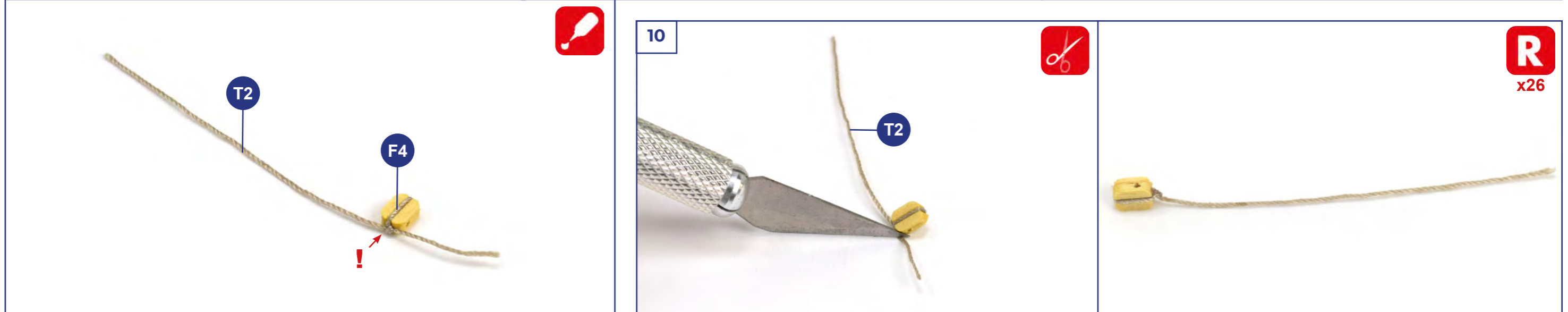
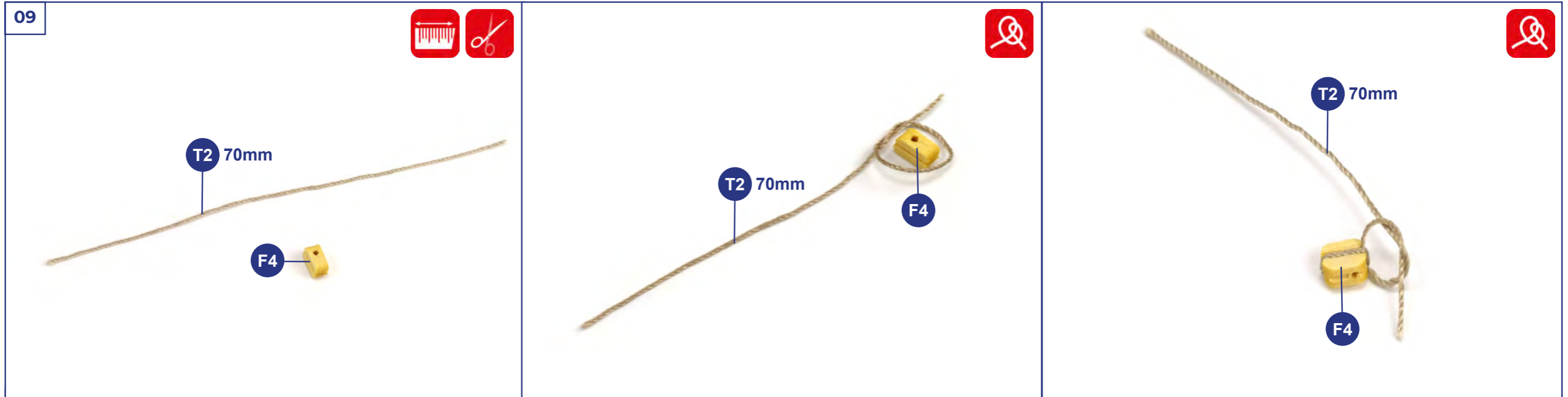

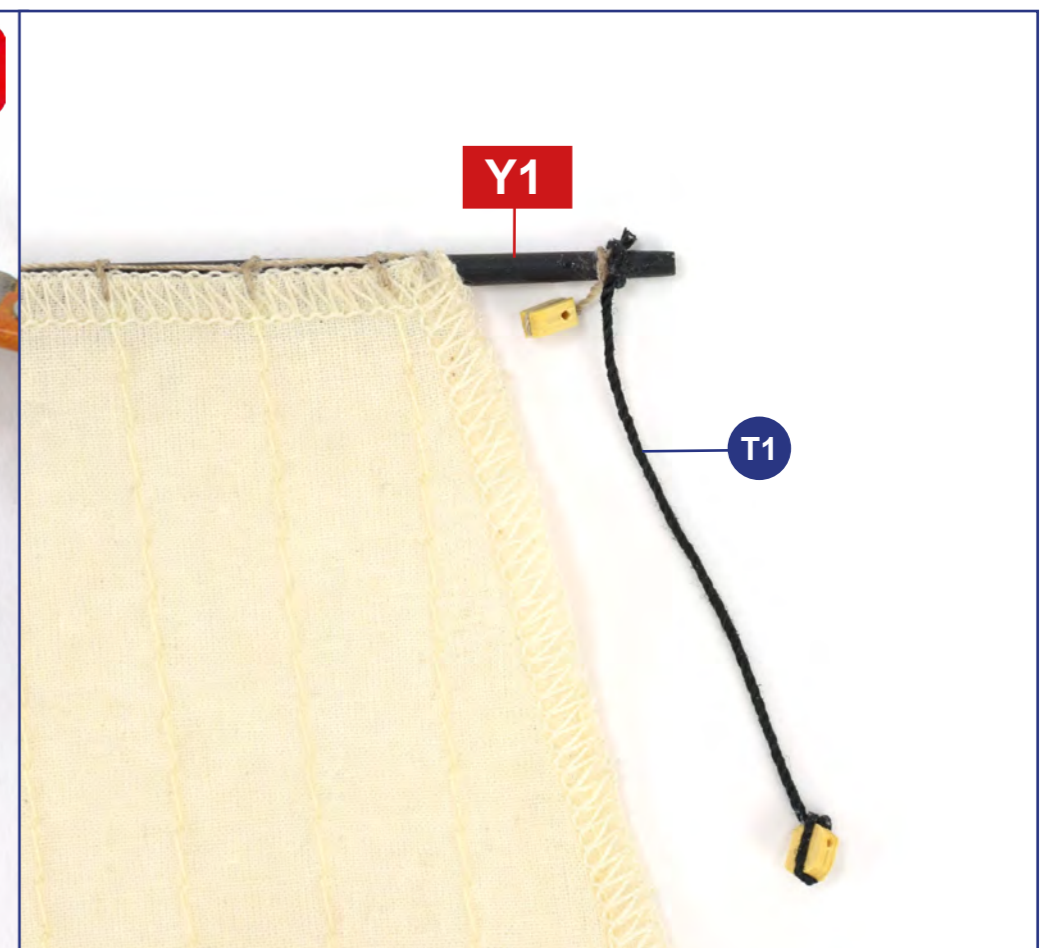
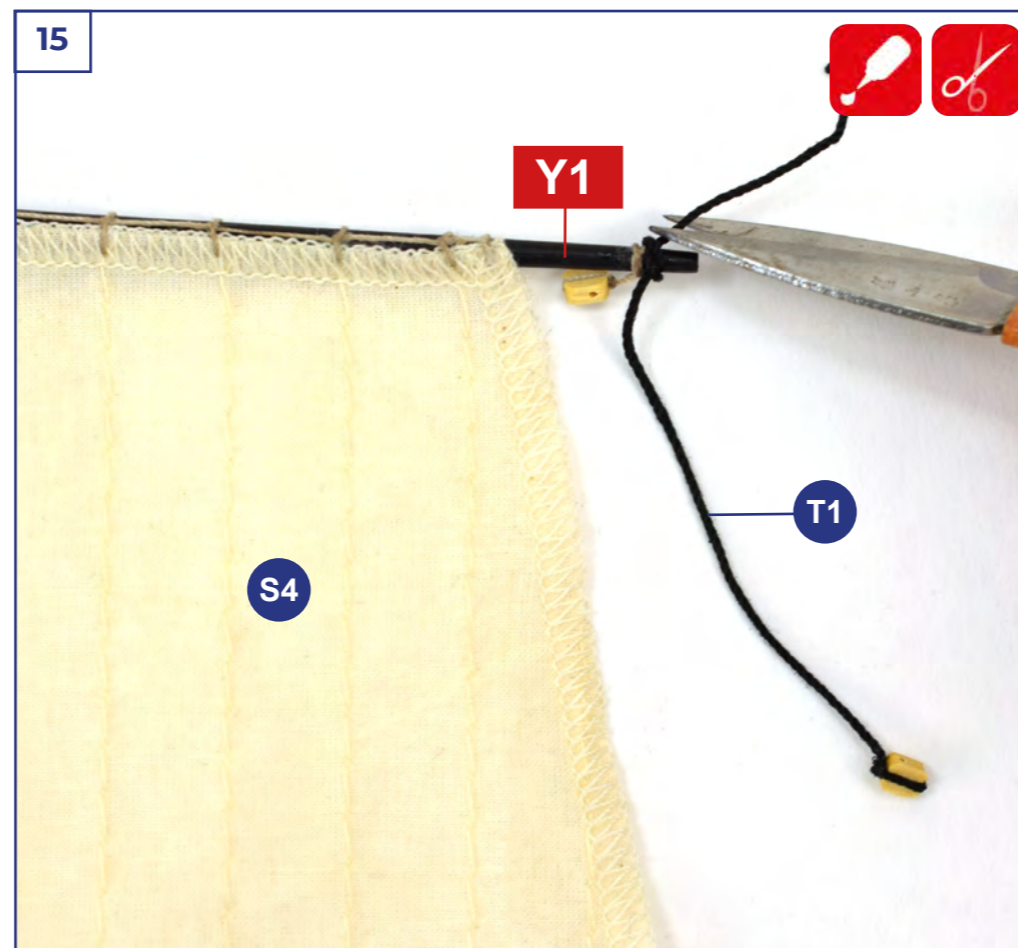
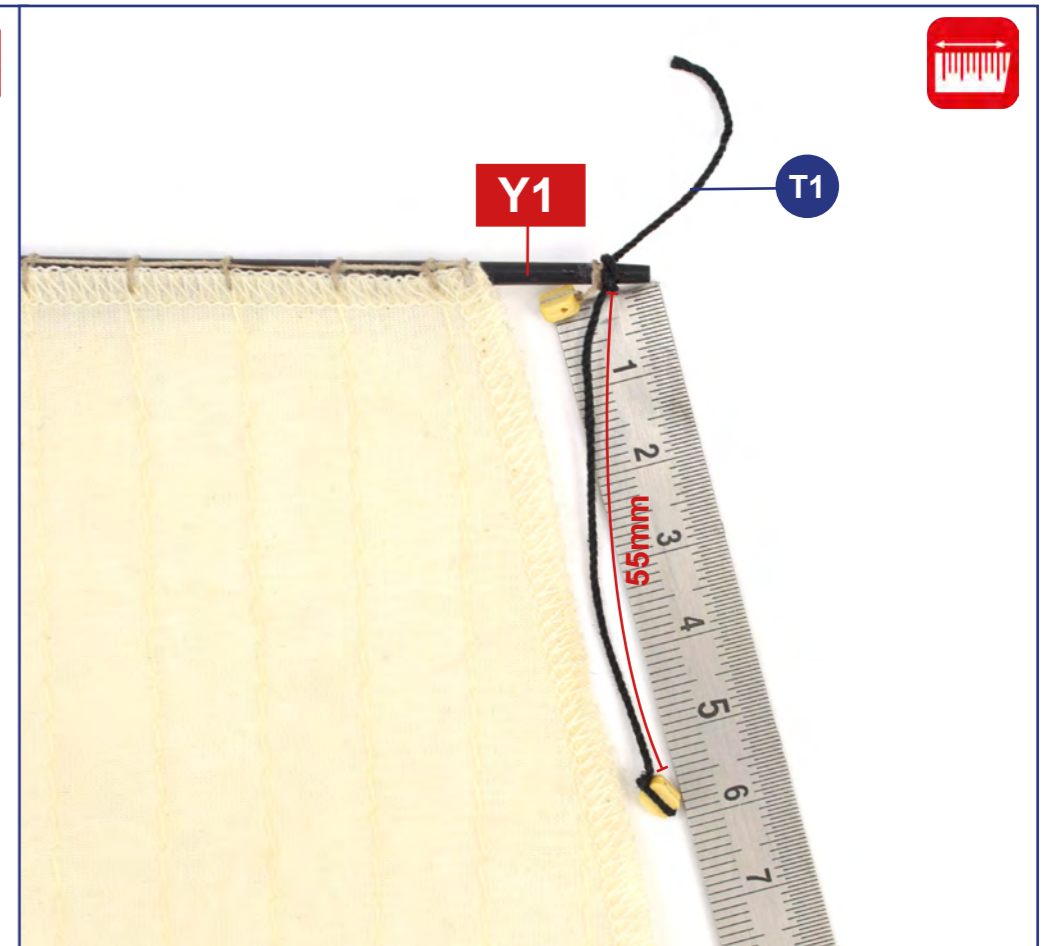
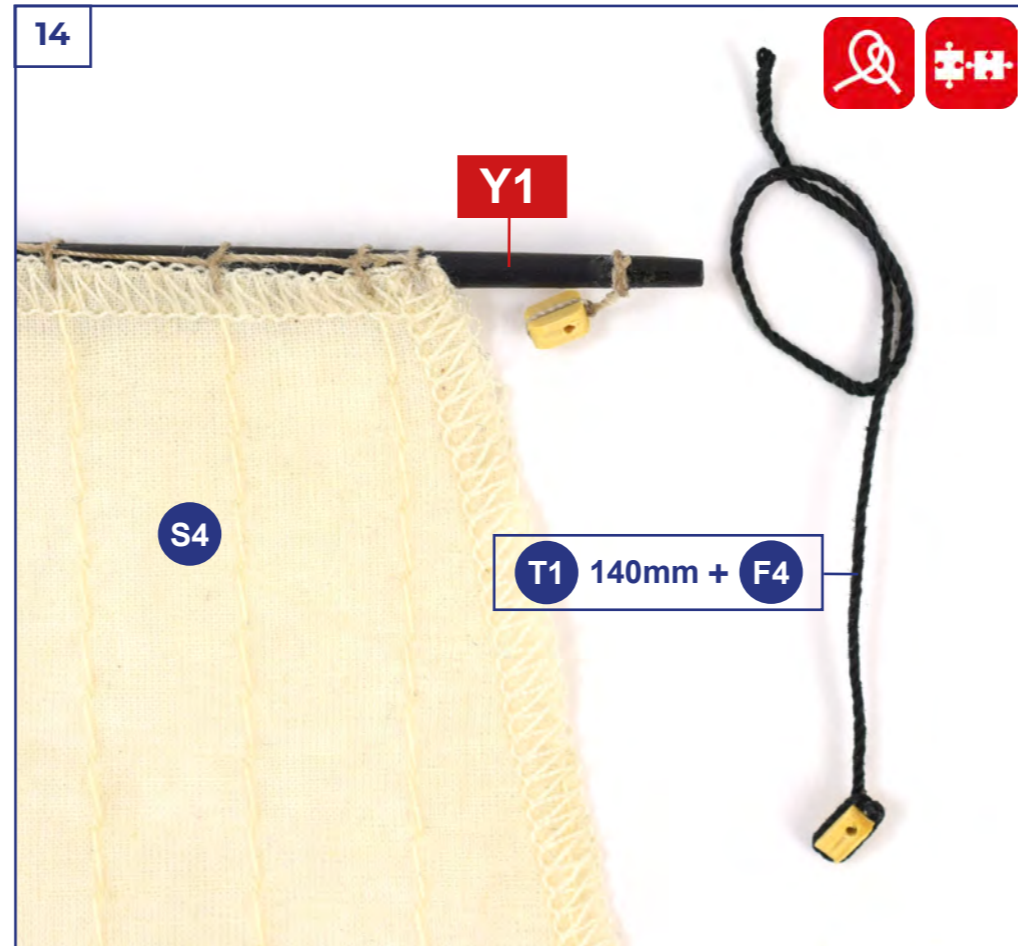
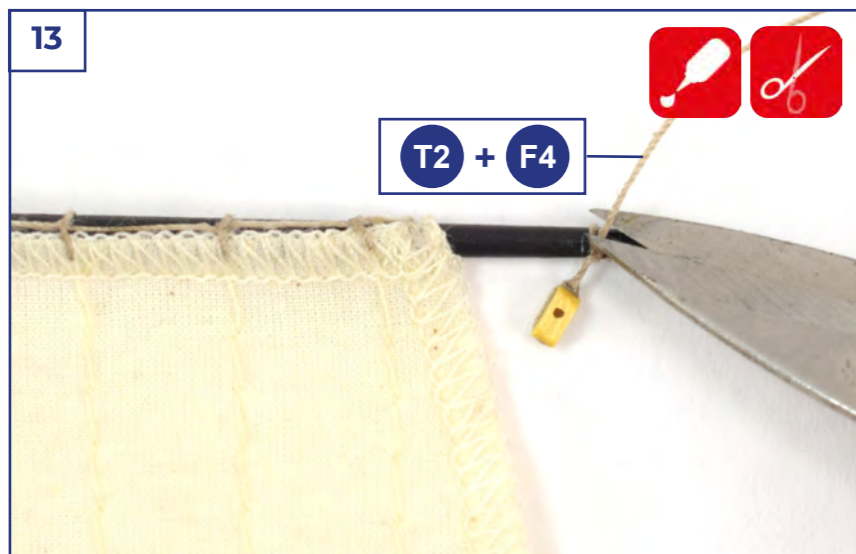
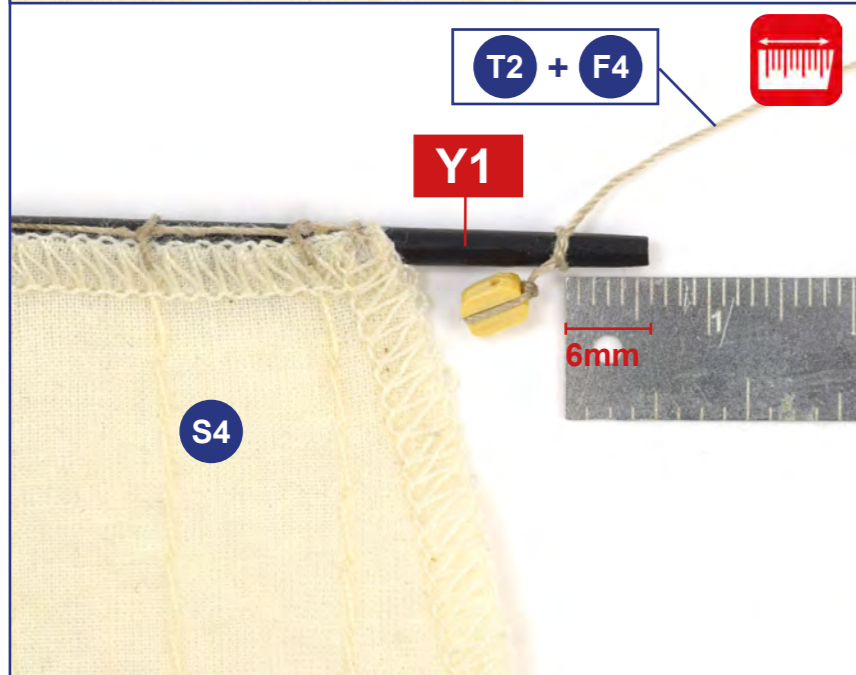
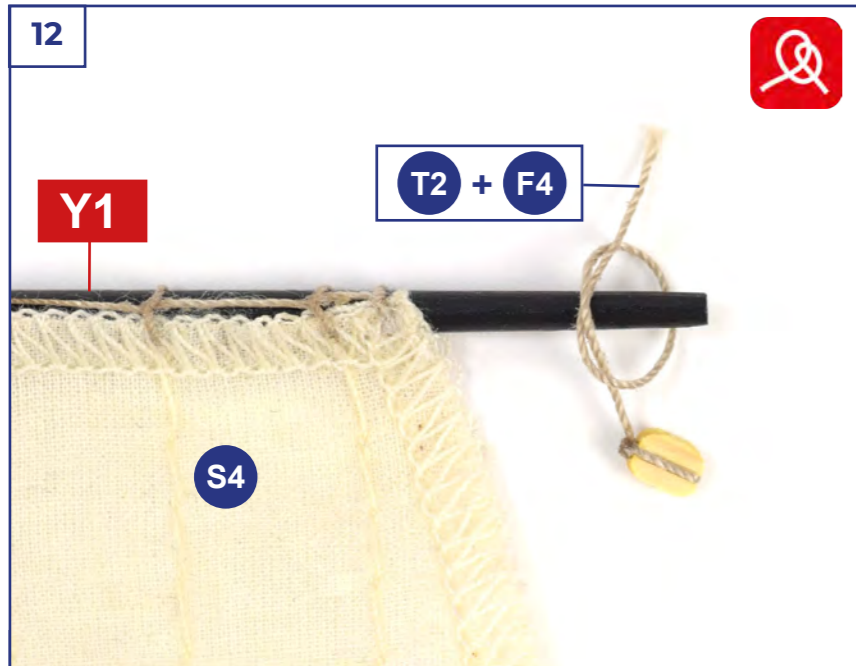

16



01

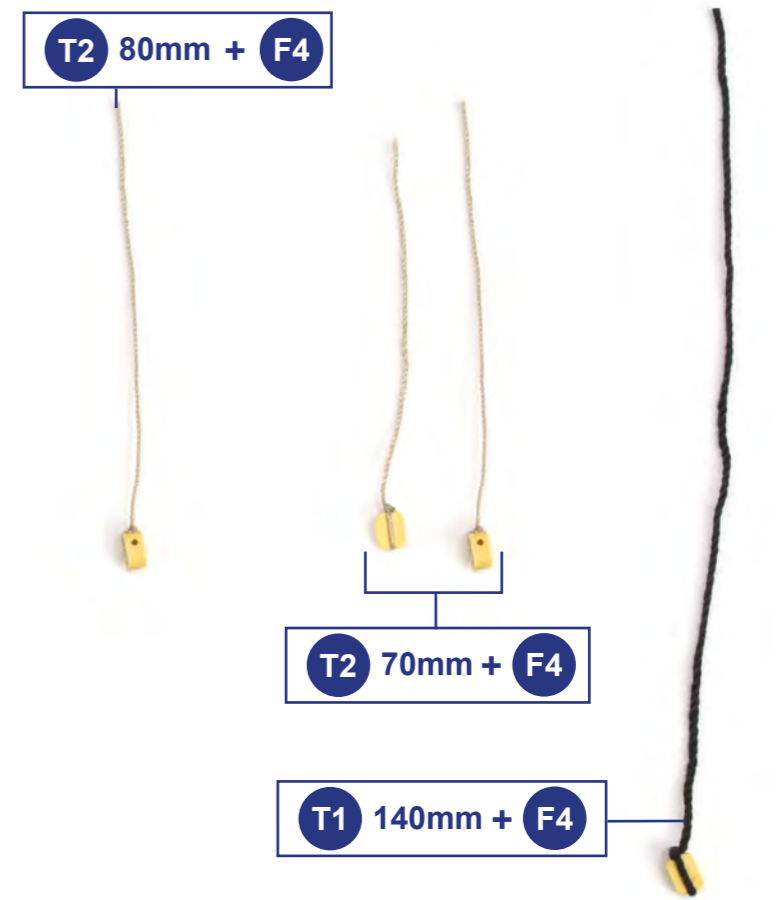
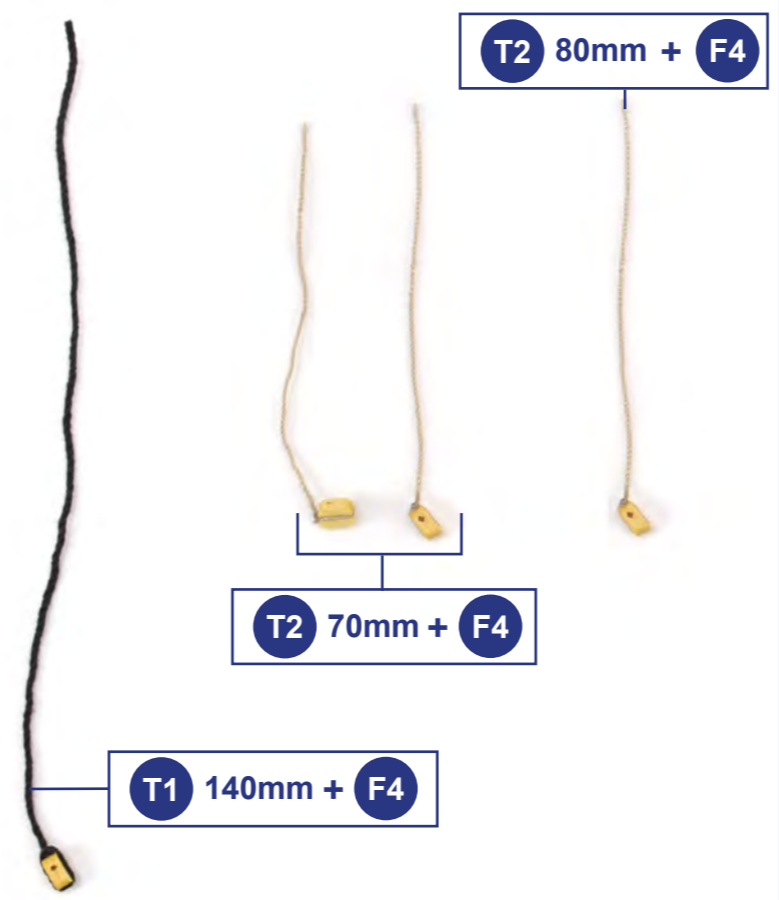
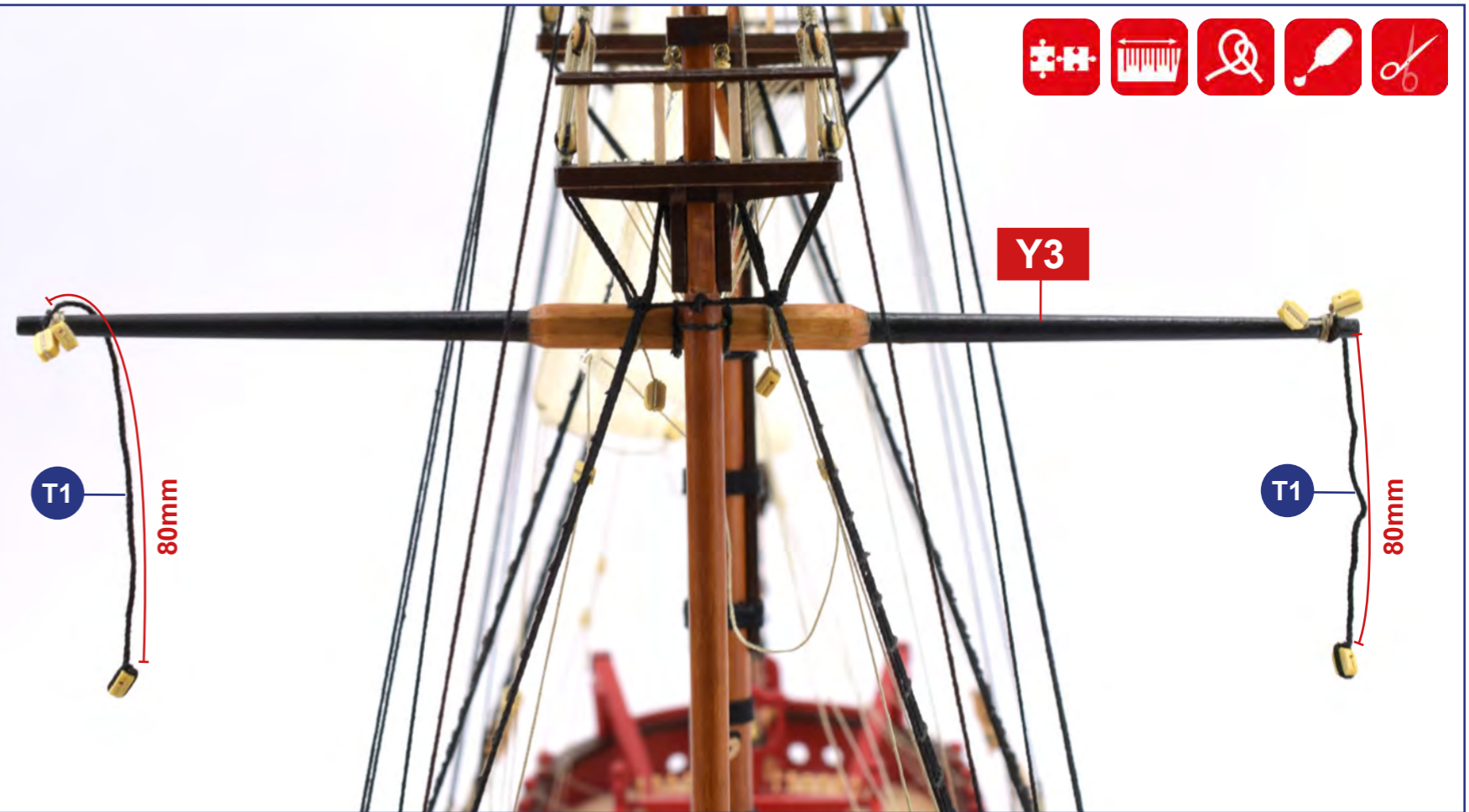

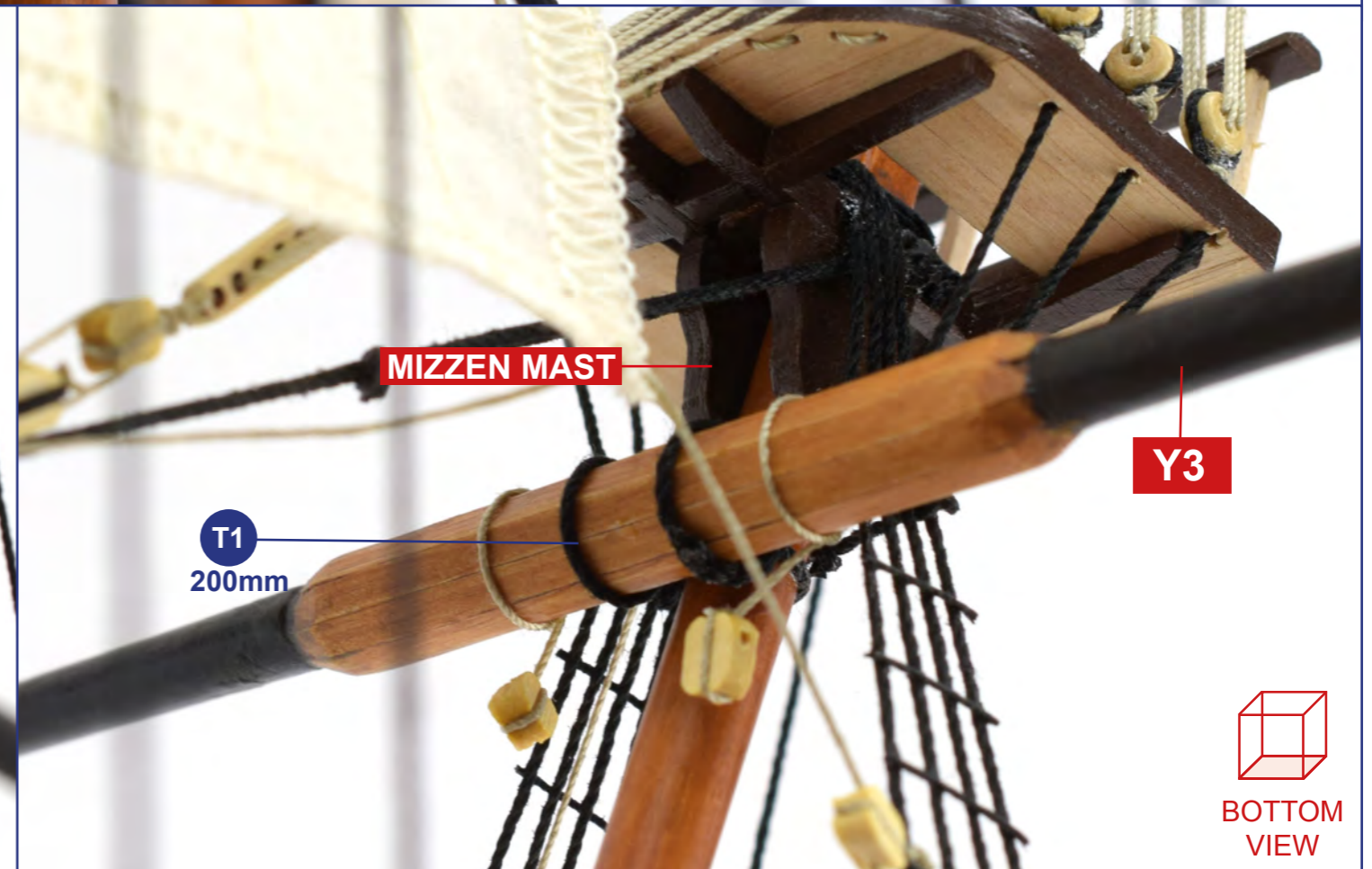
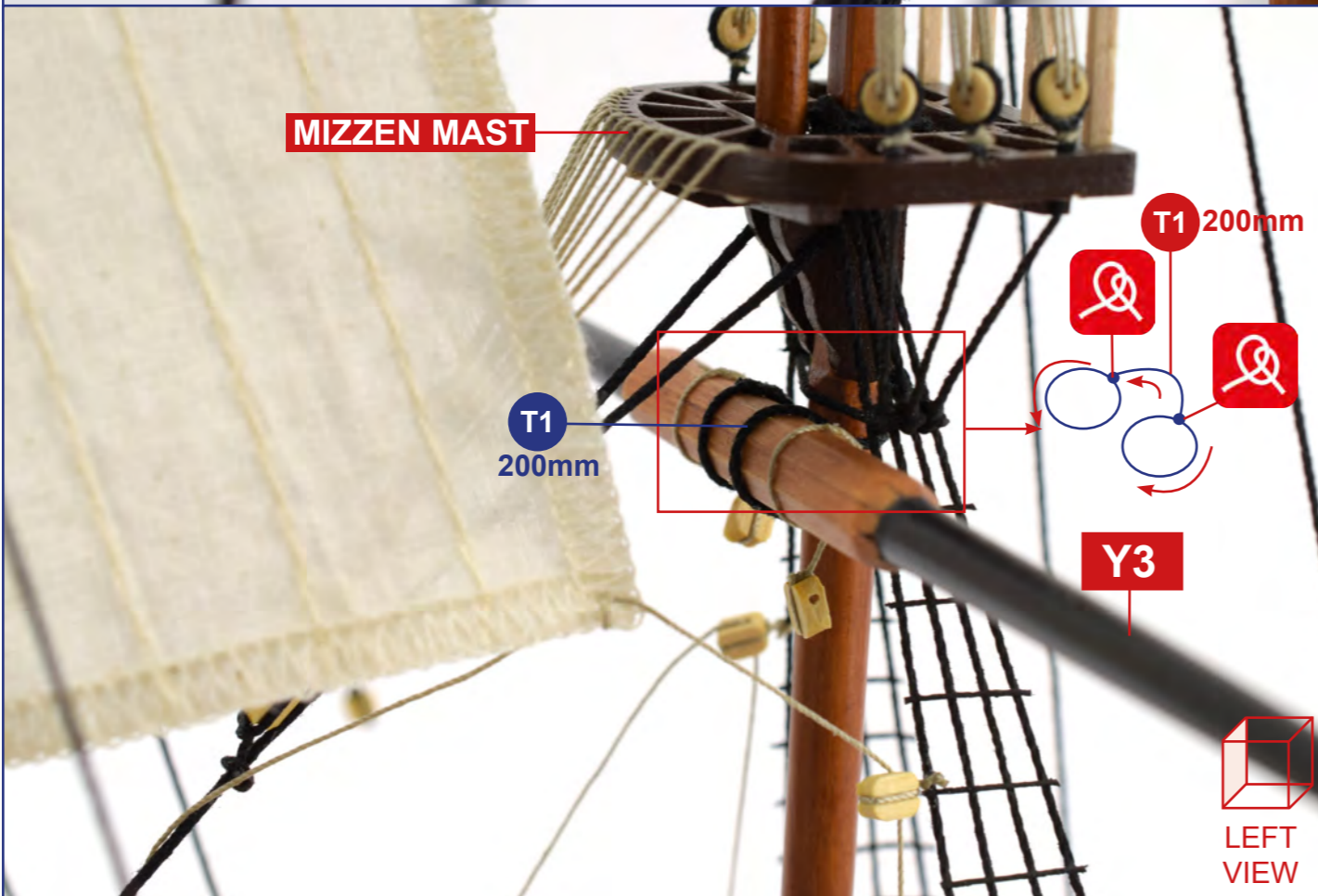
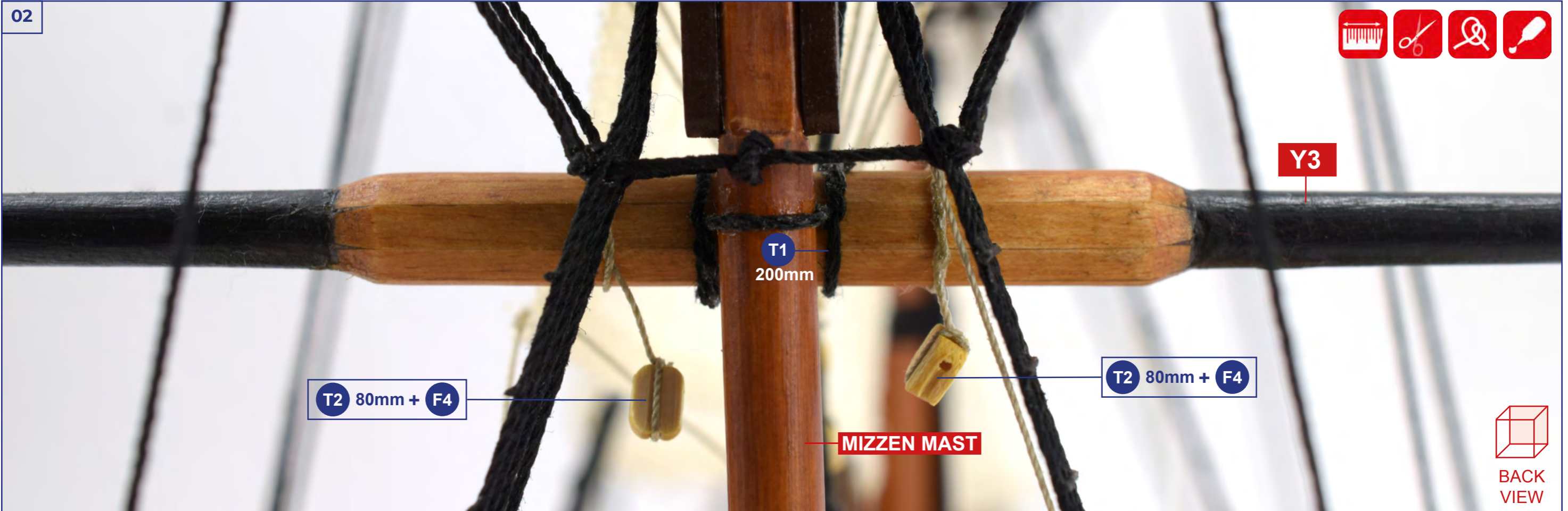

03

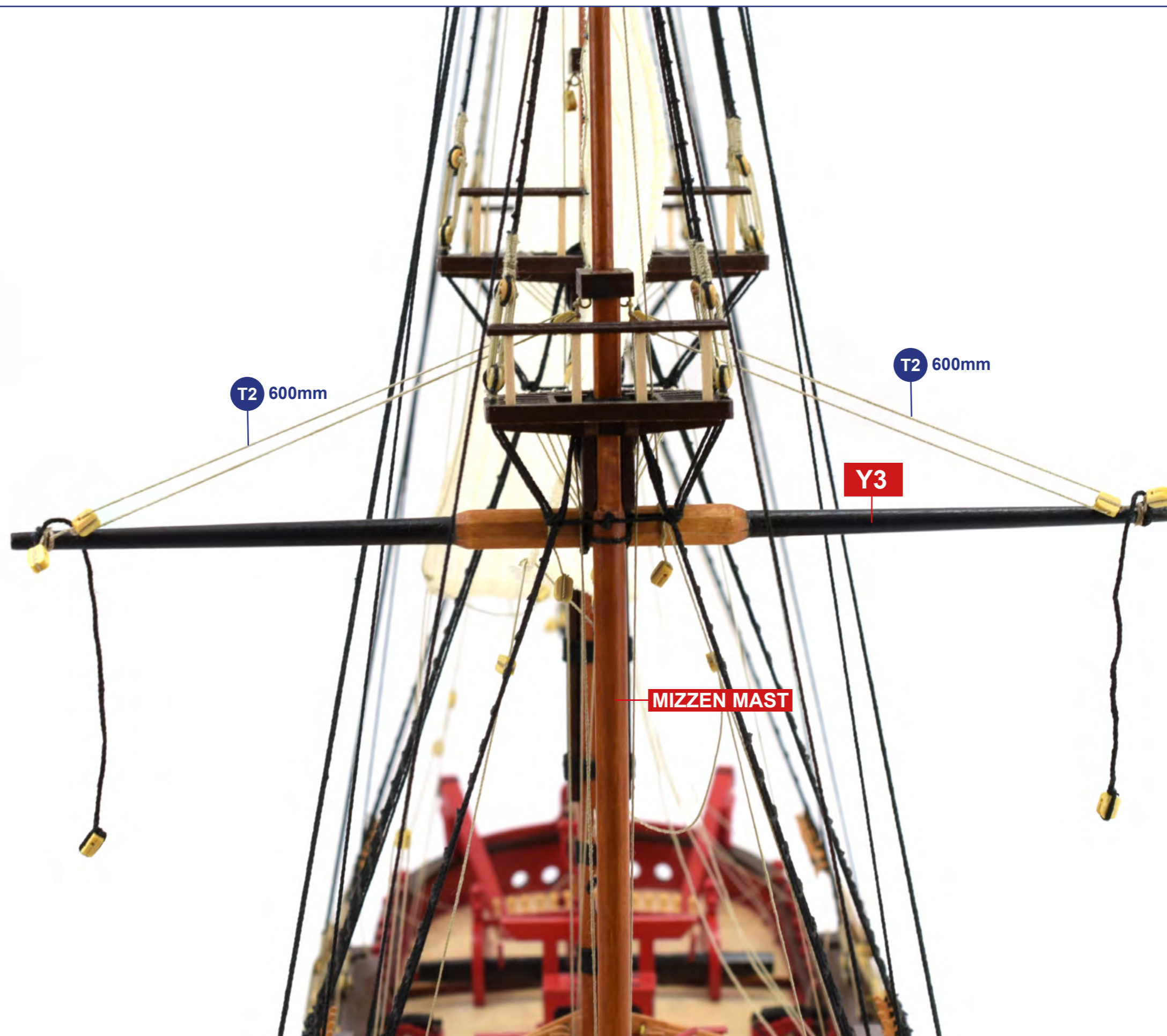

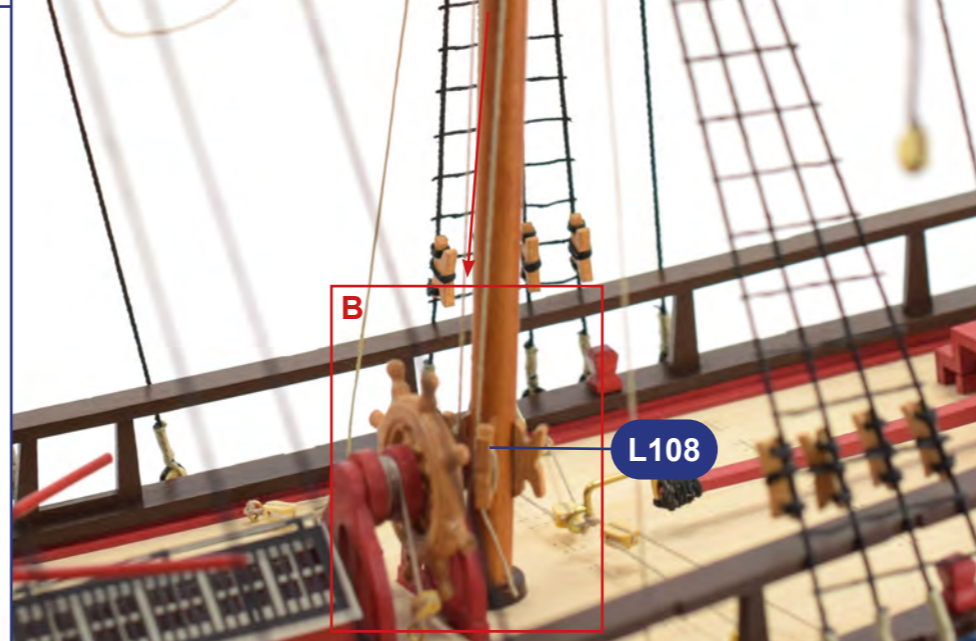
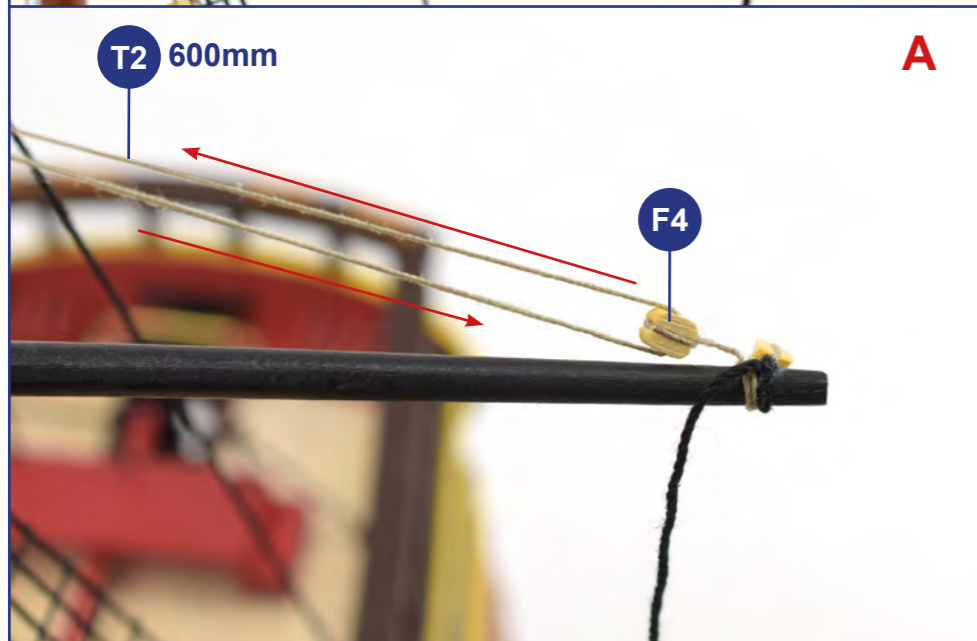
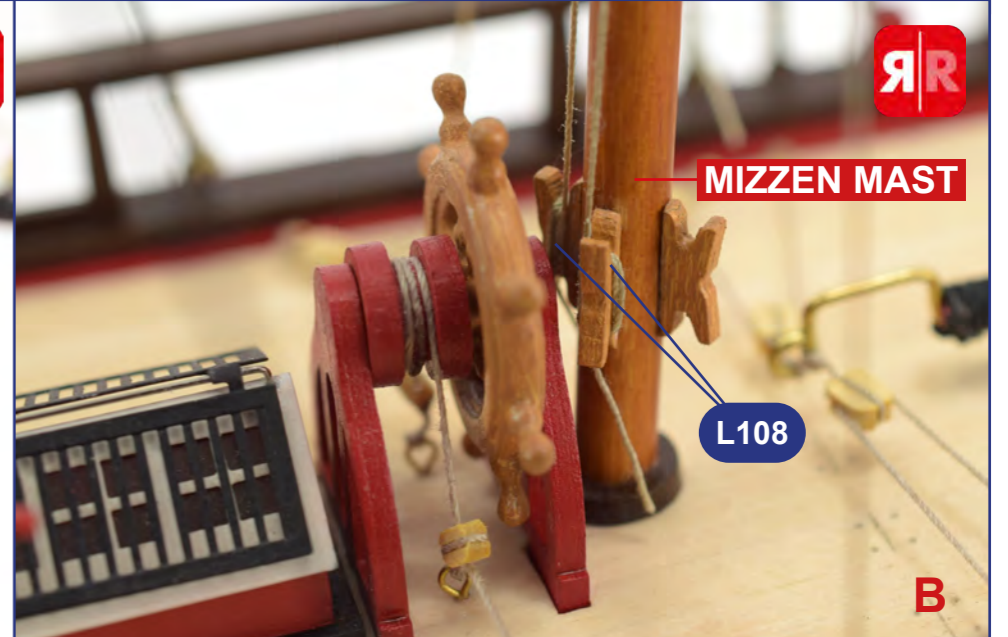
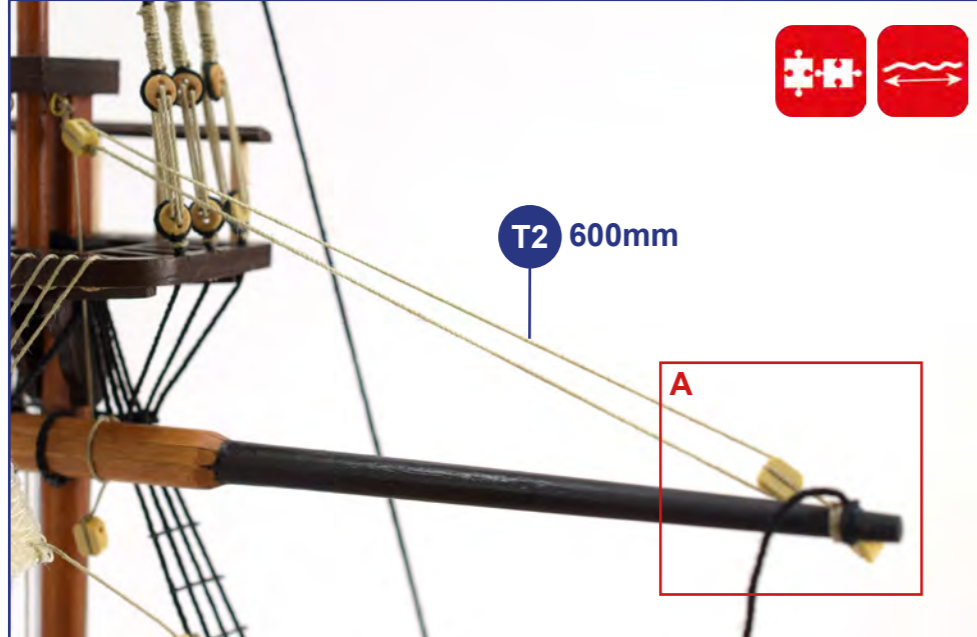
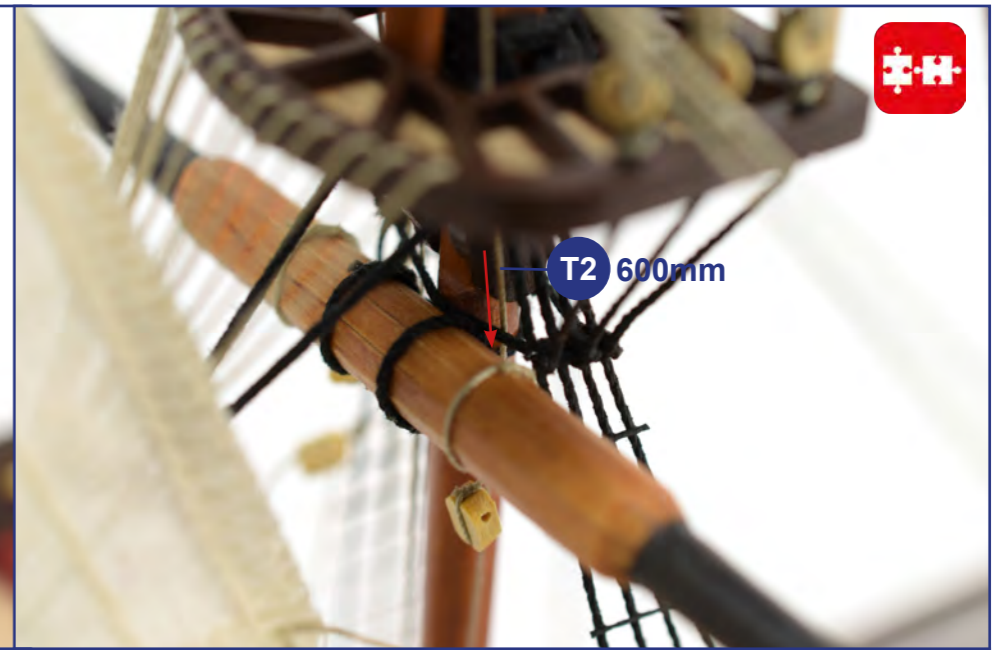
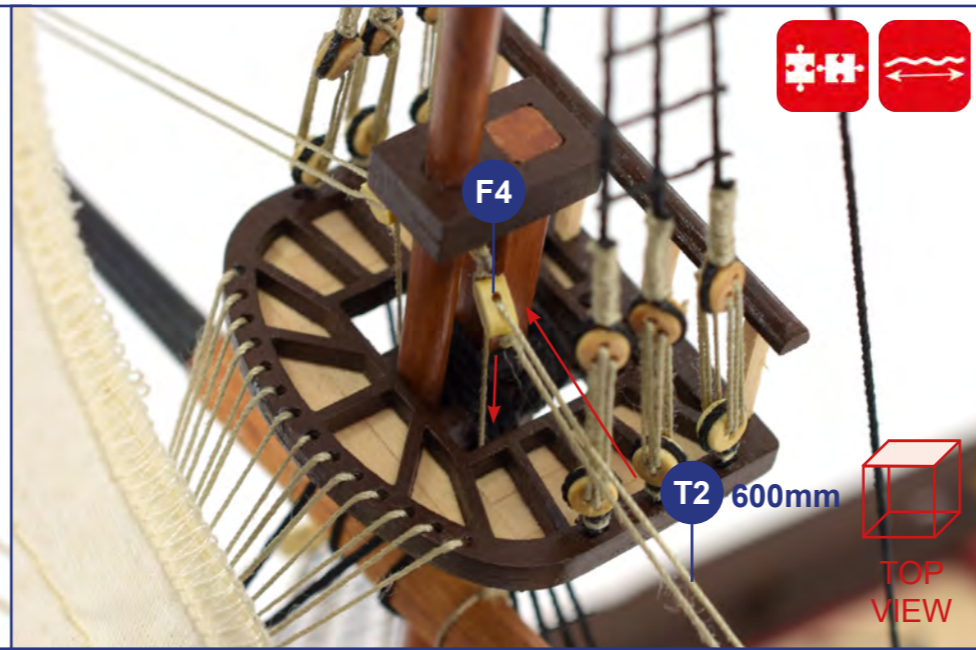
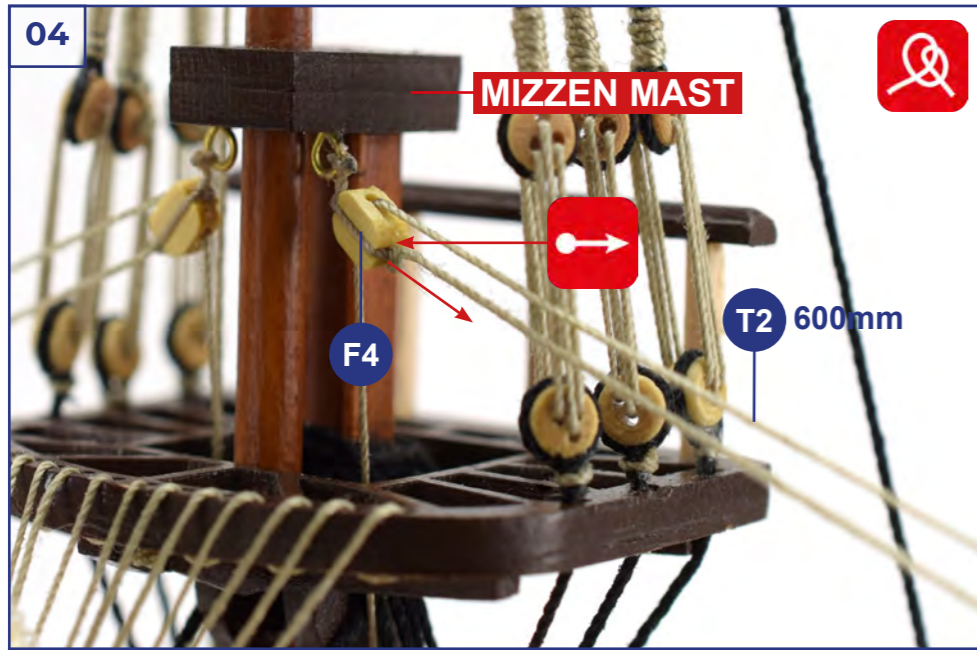

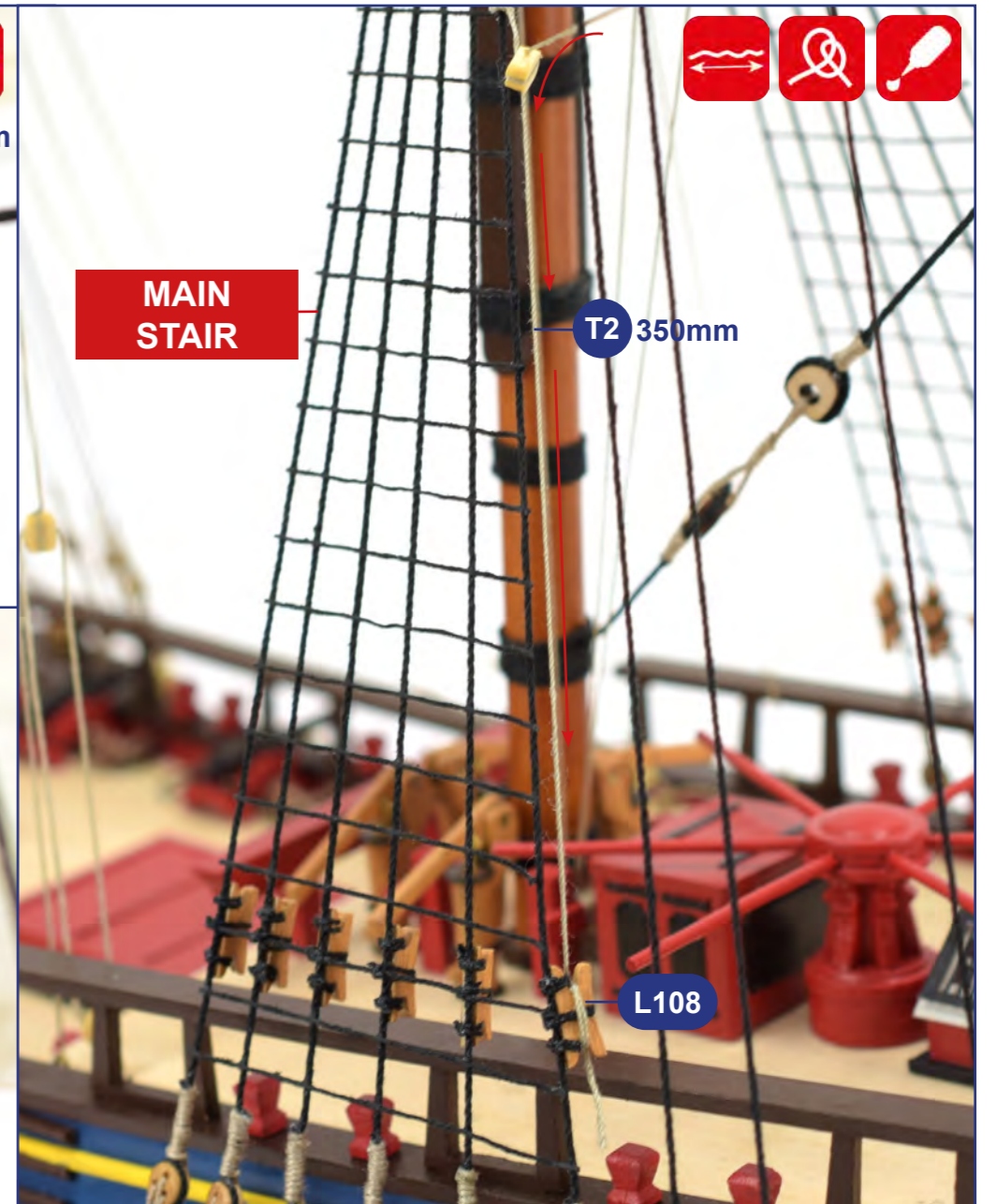
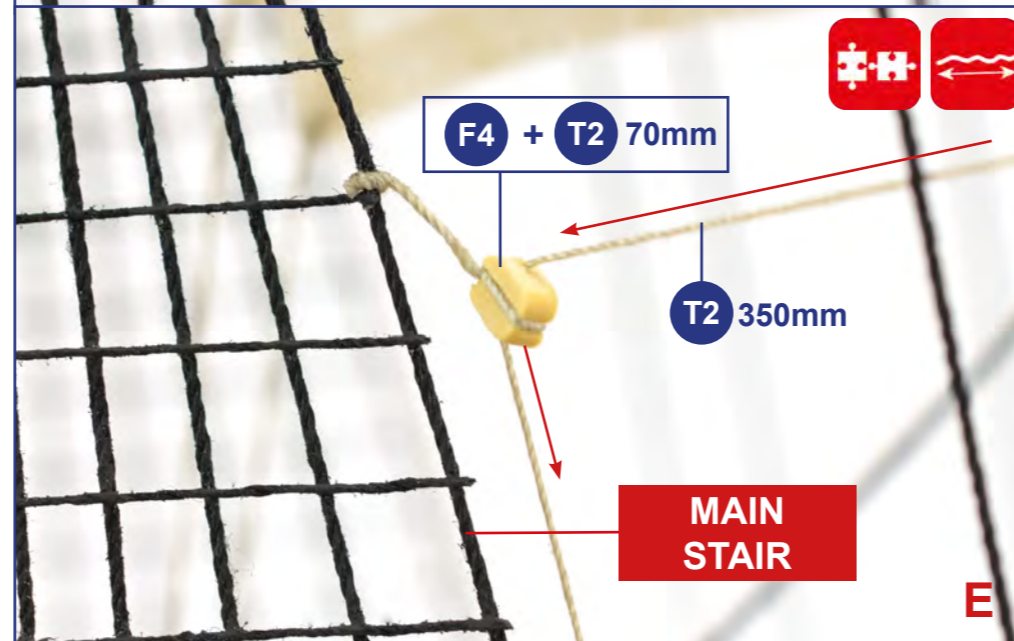
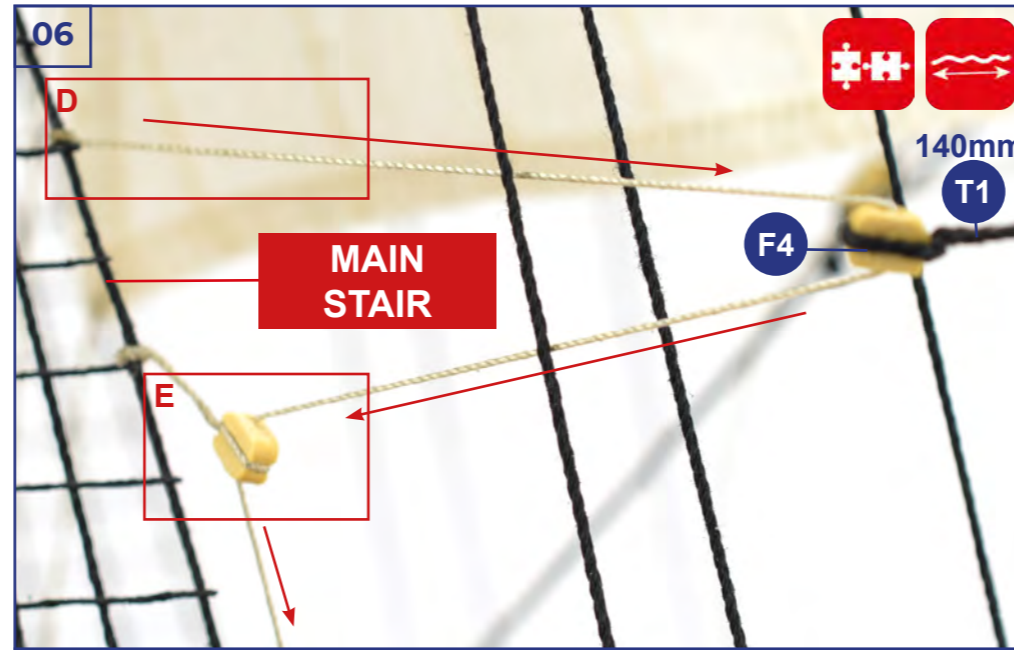
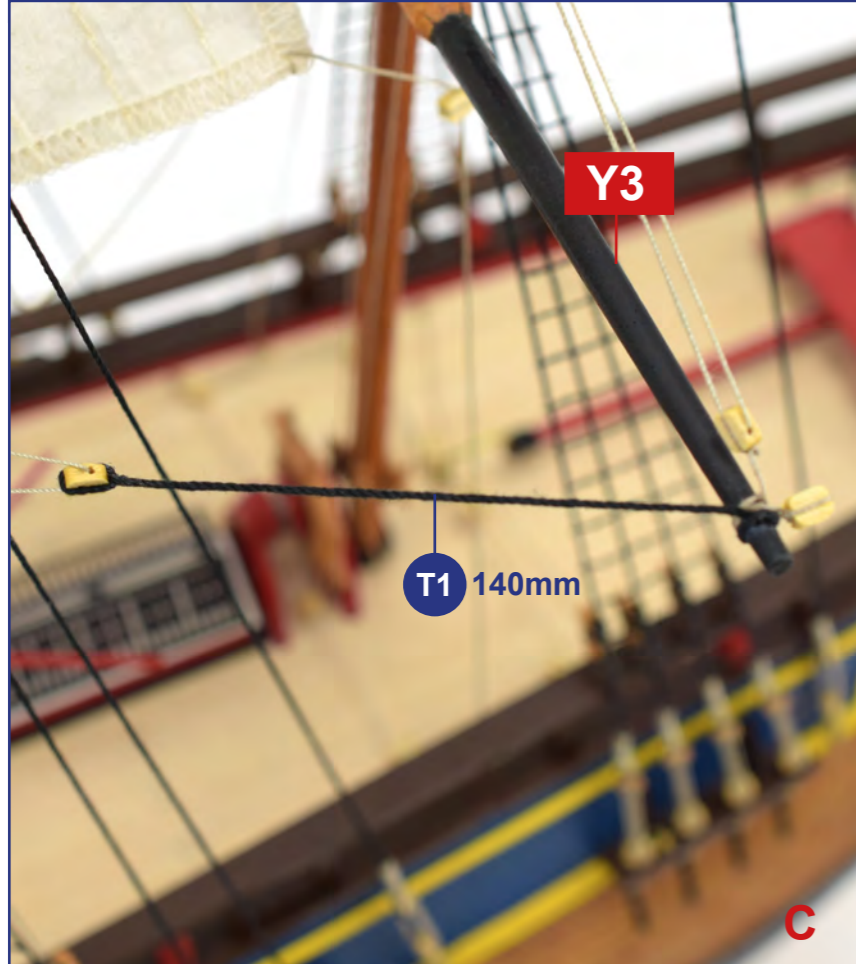
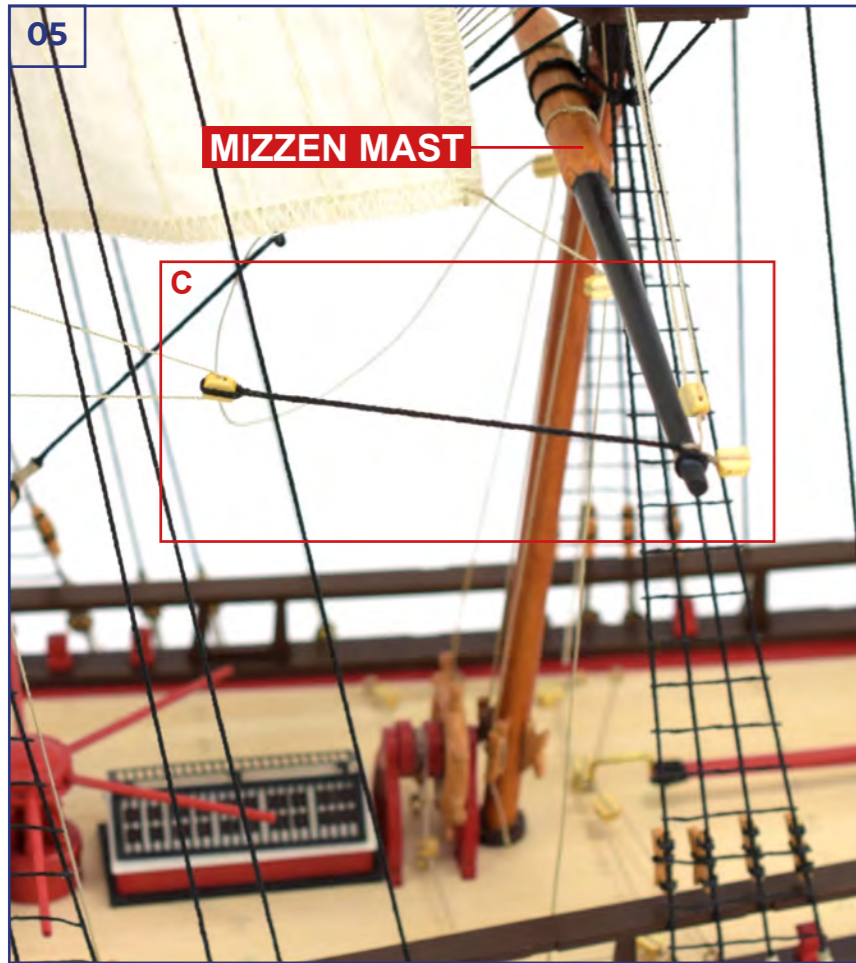

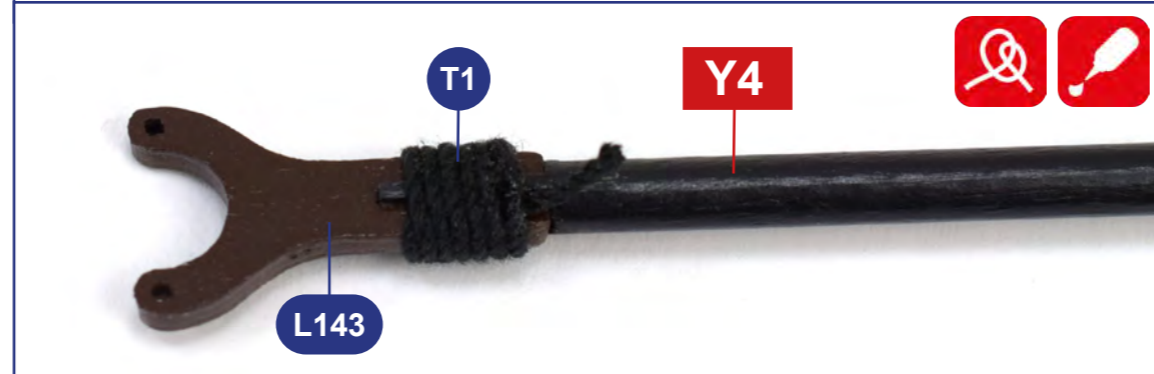
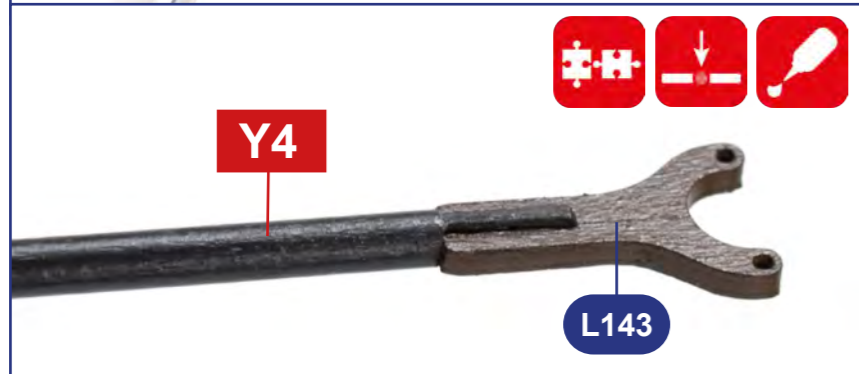
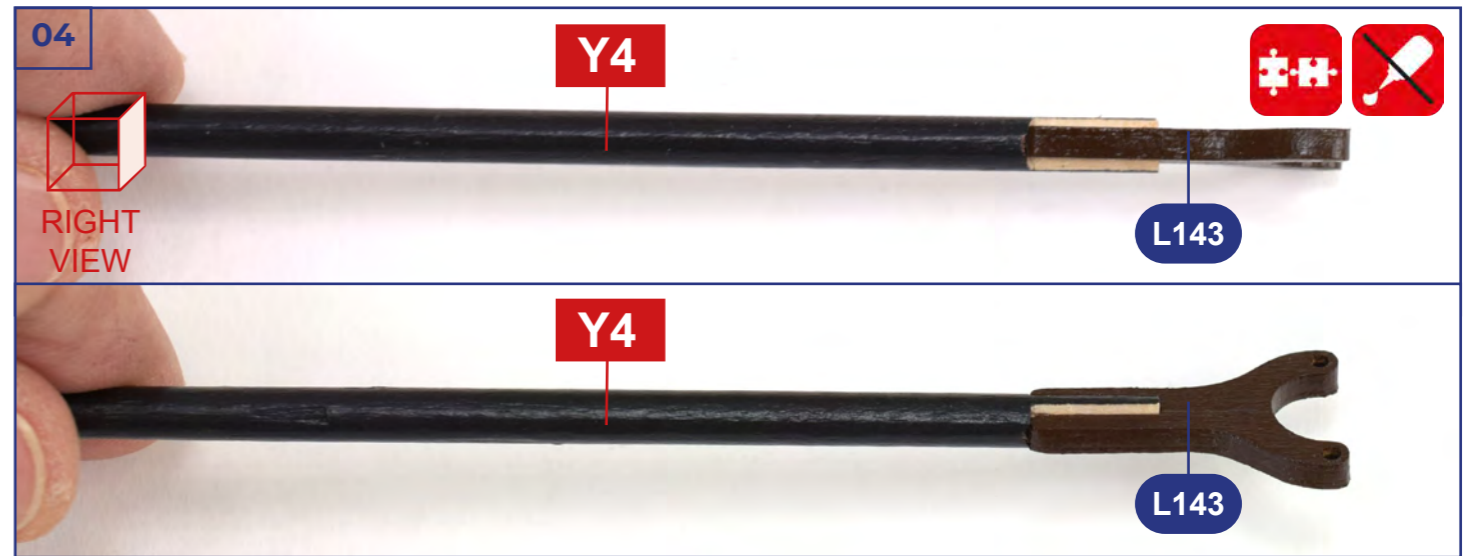
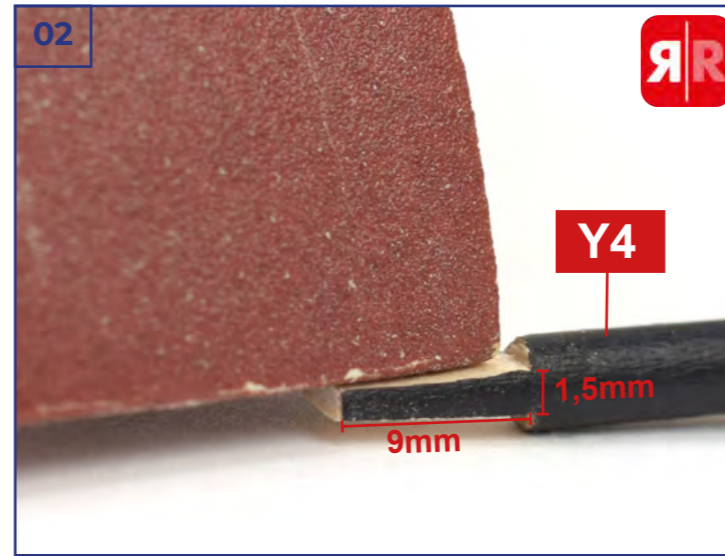
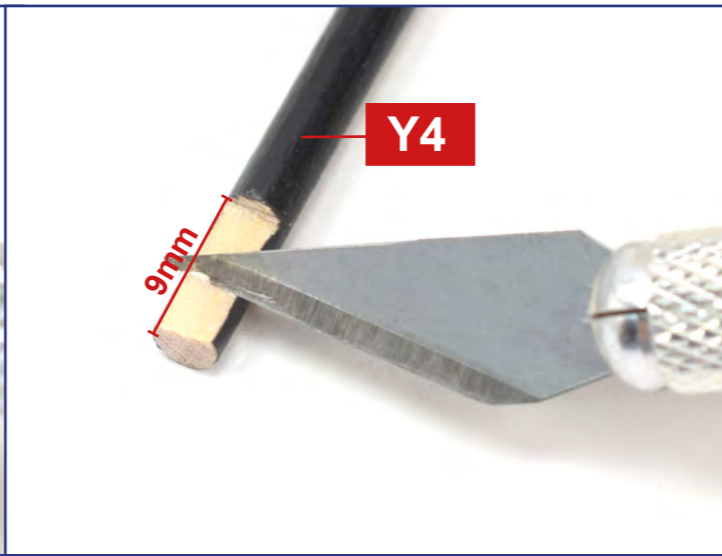
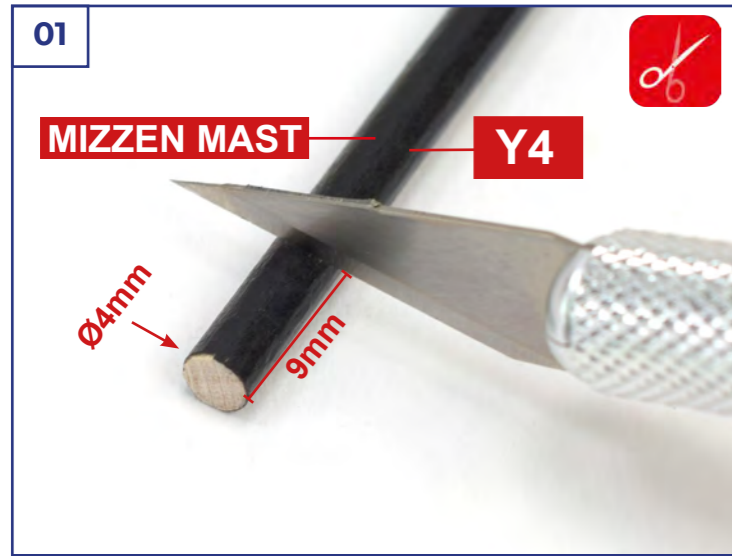

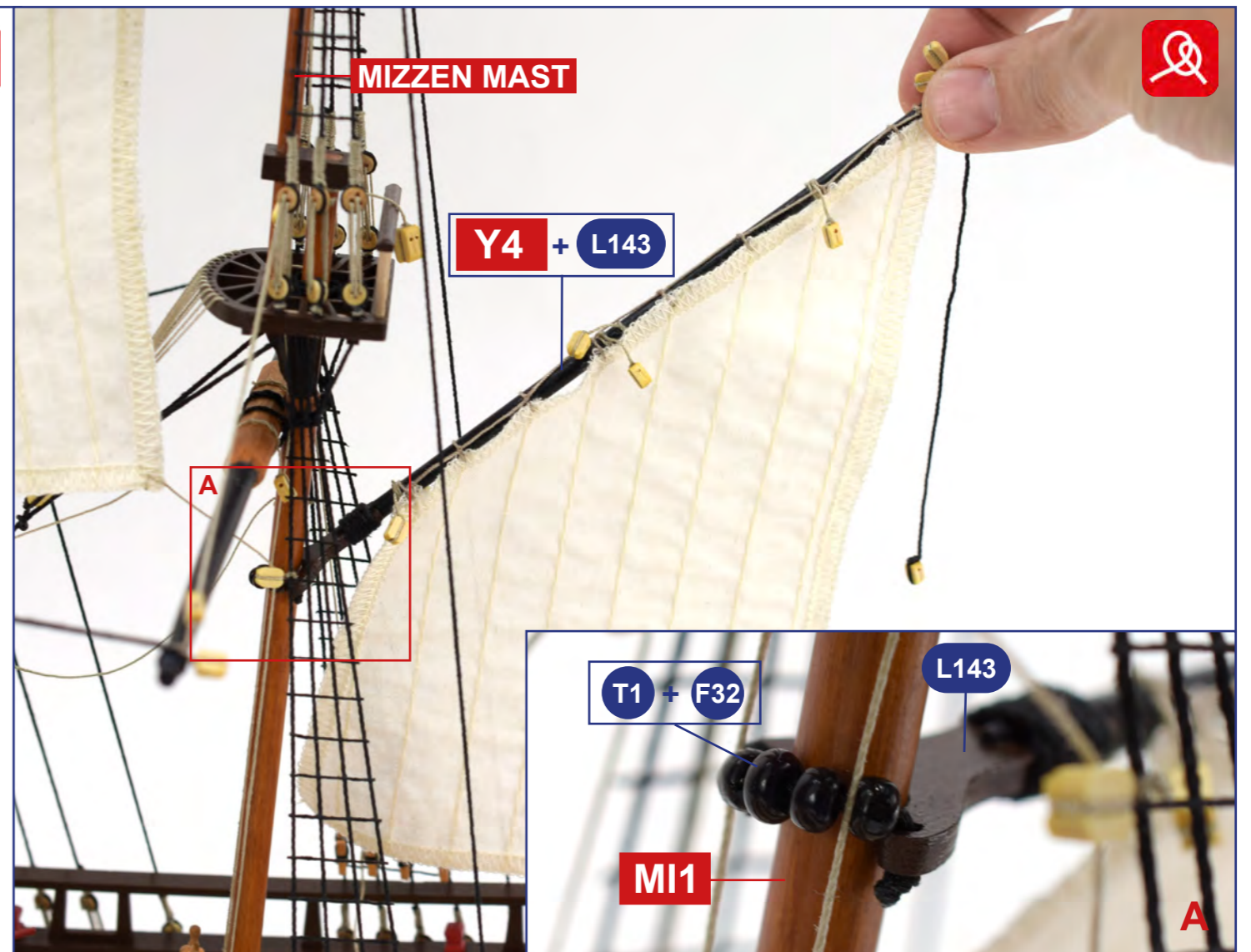
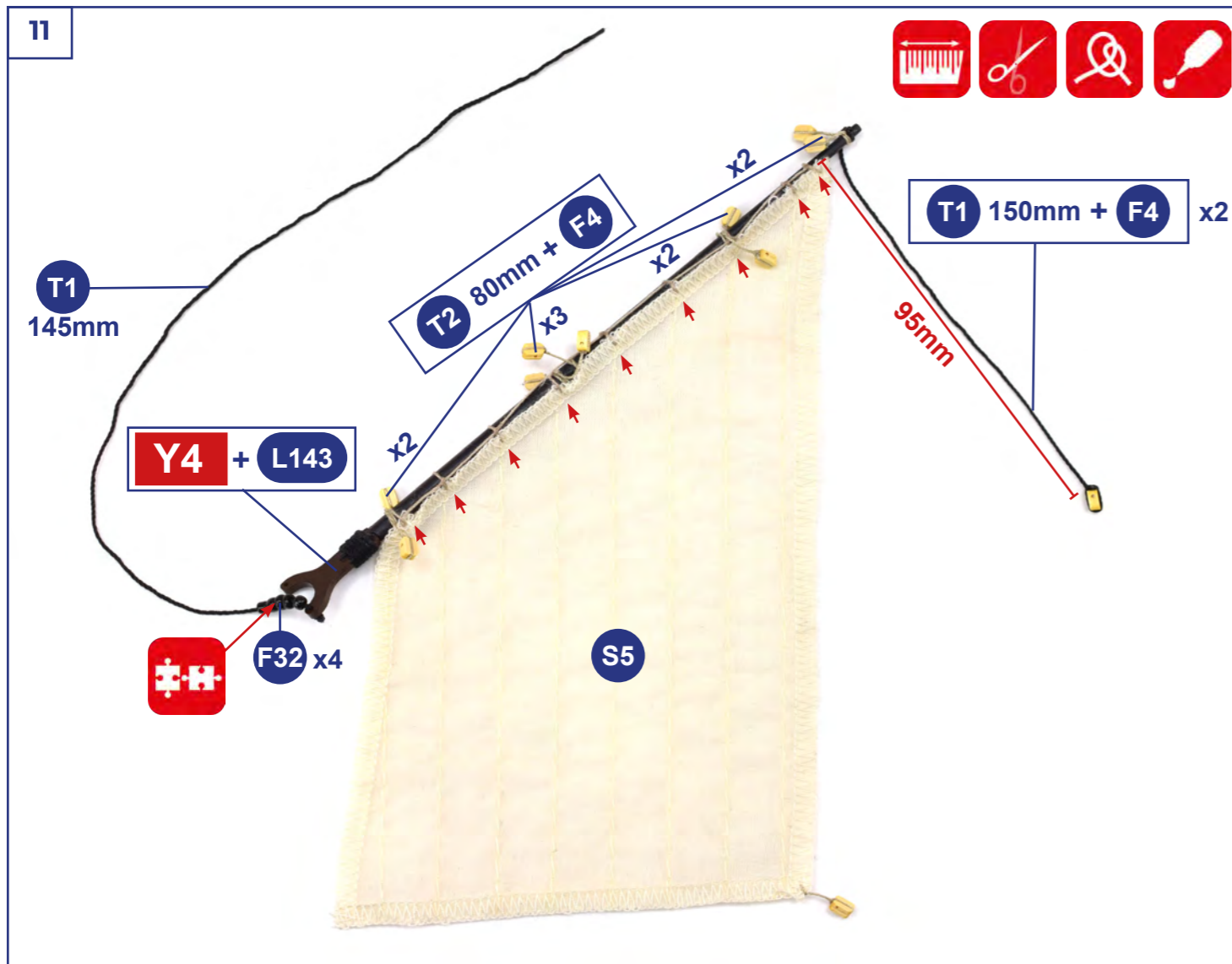
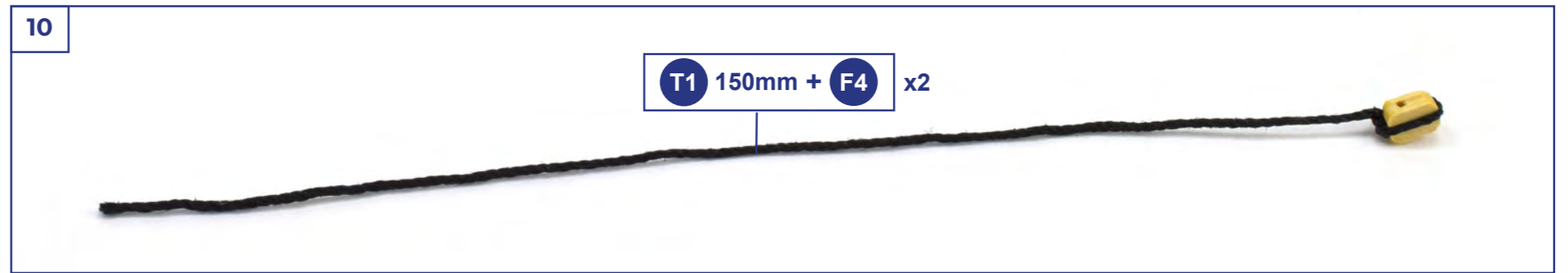
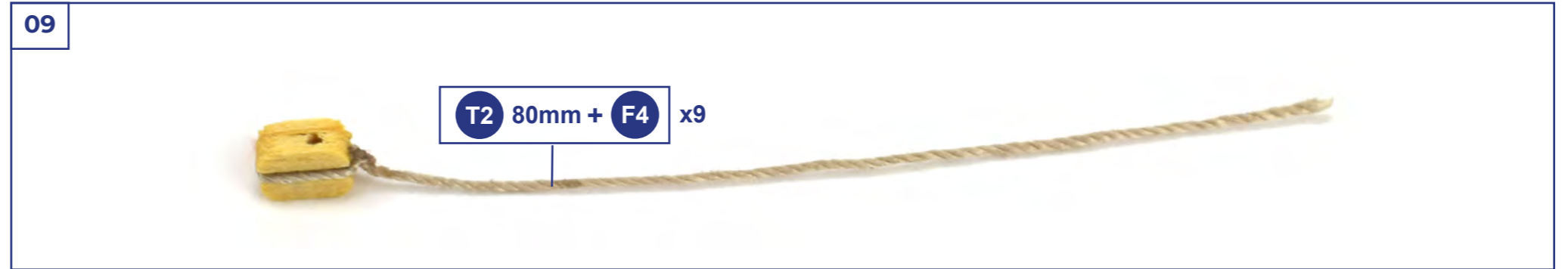
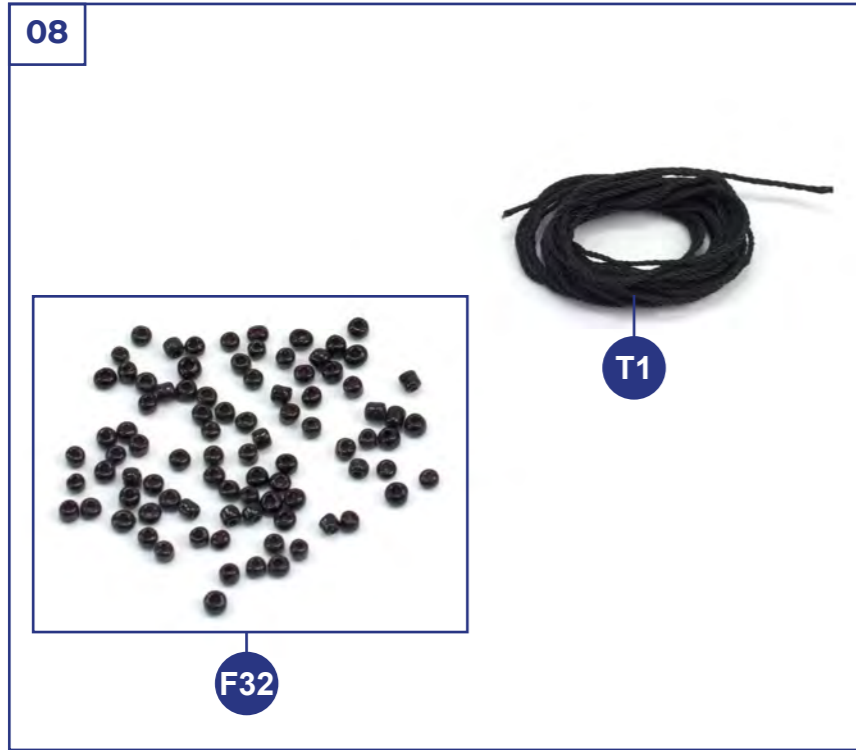

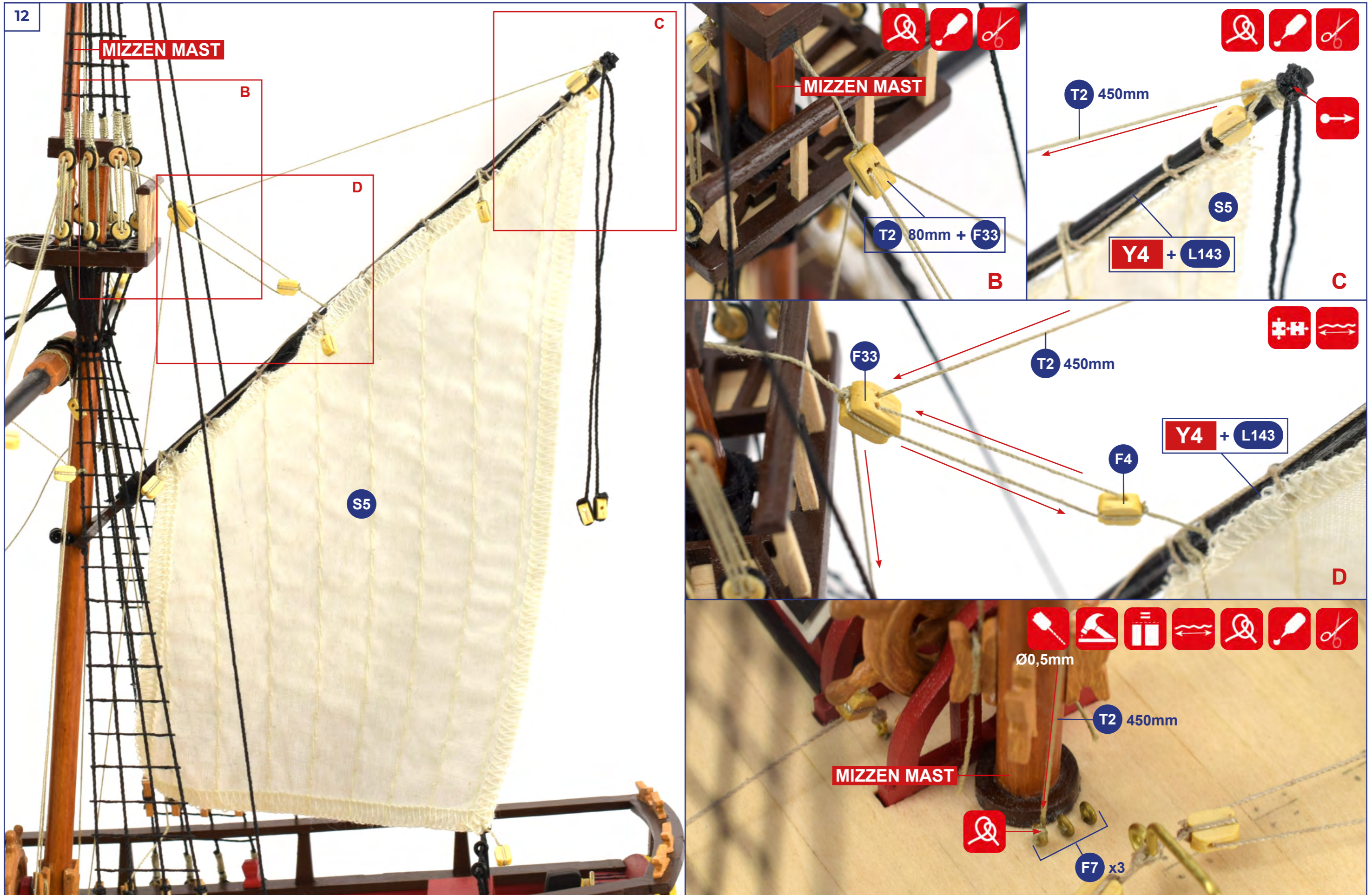

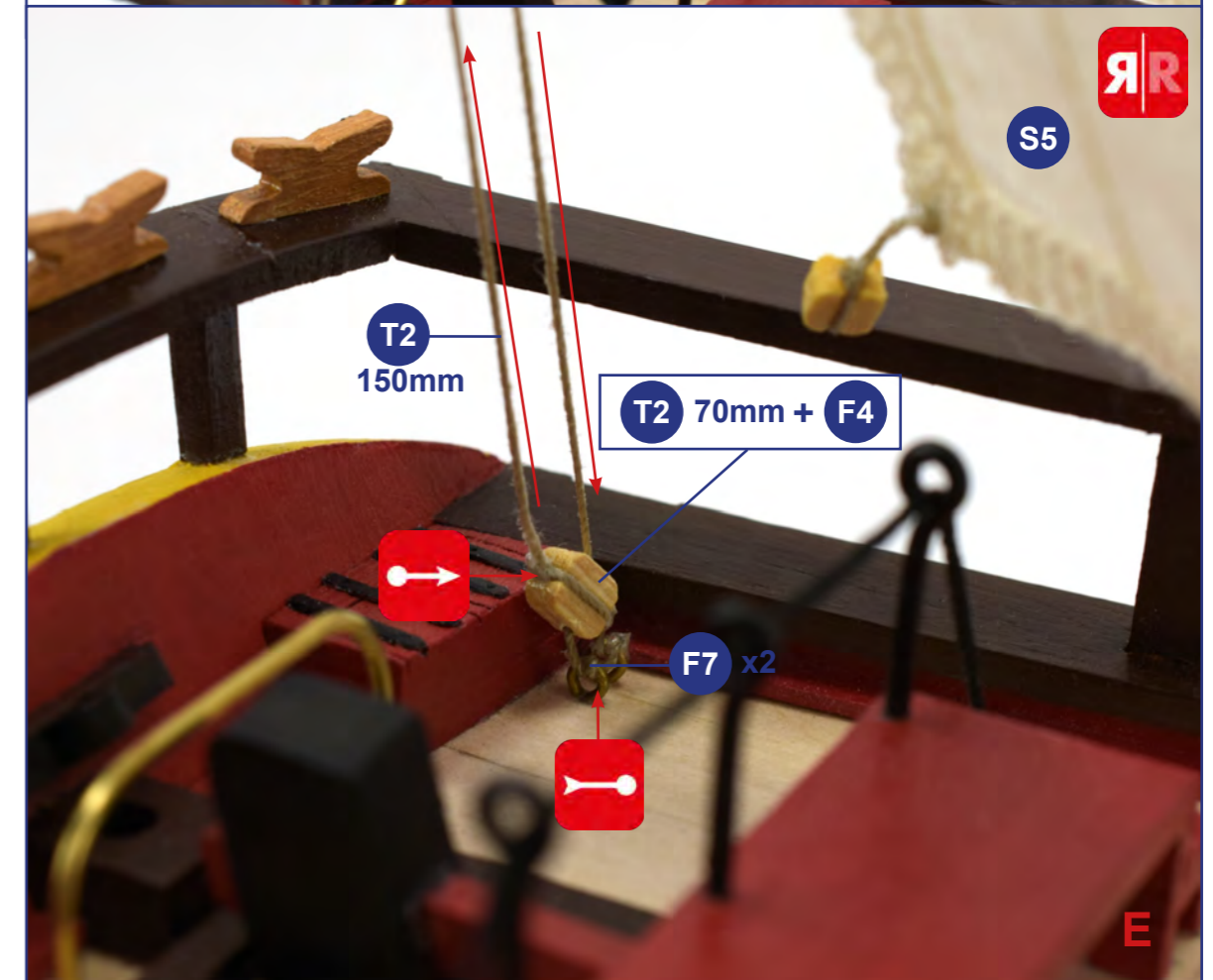
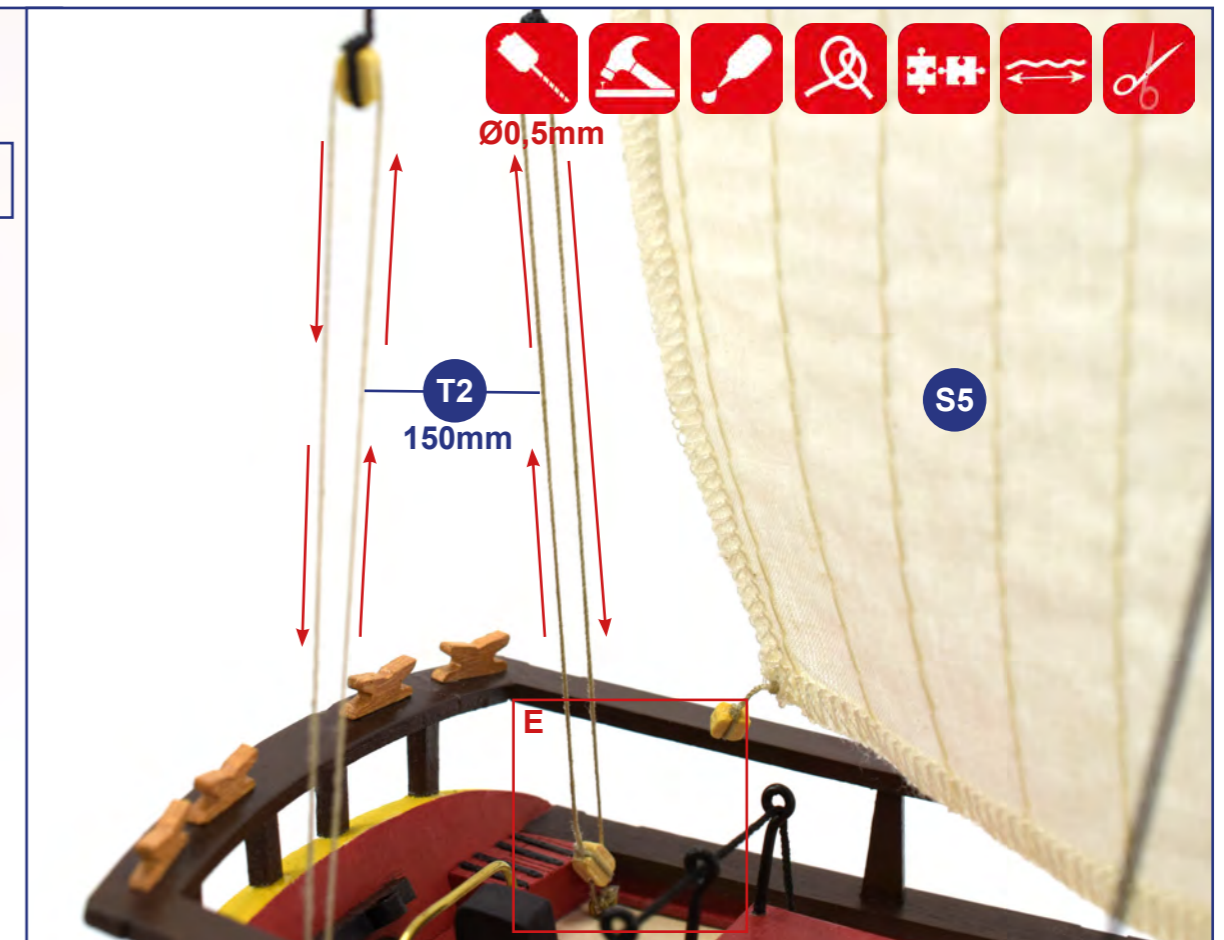

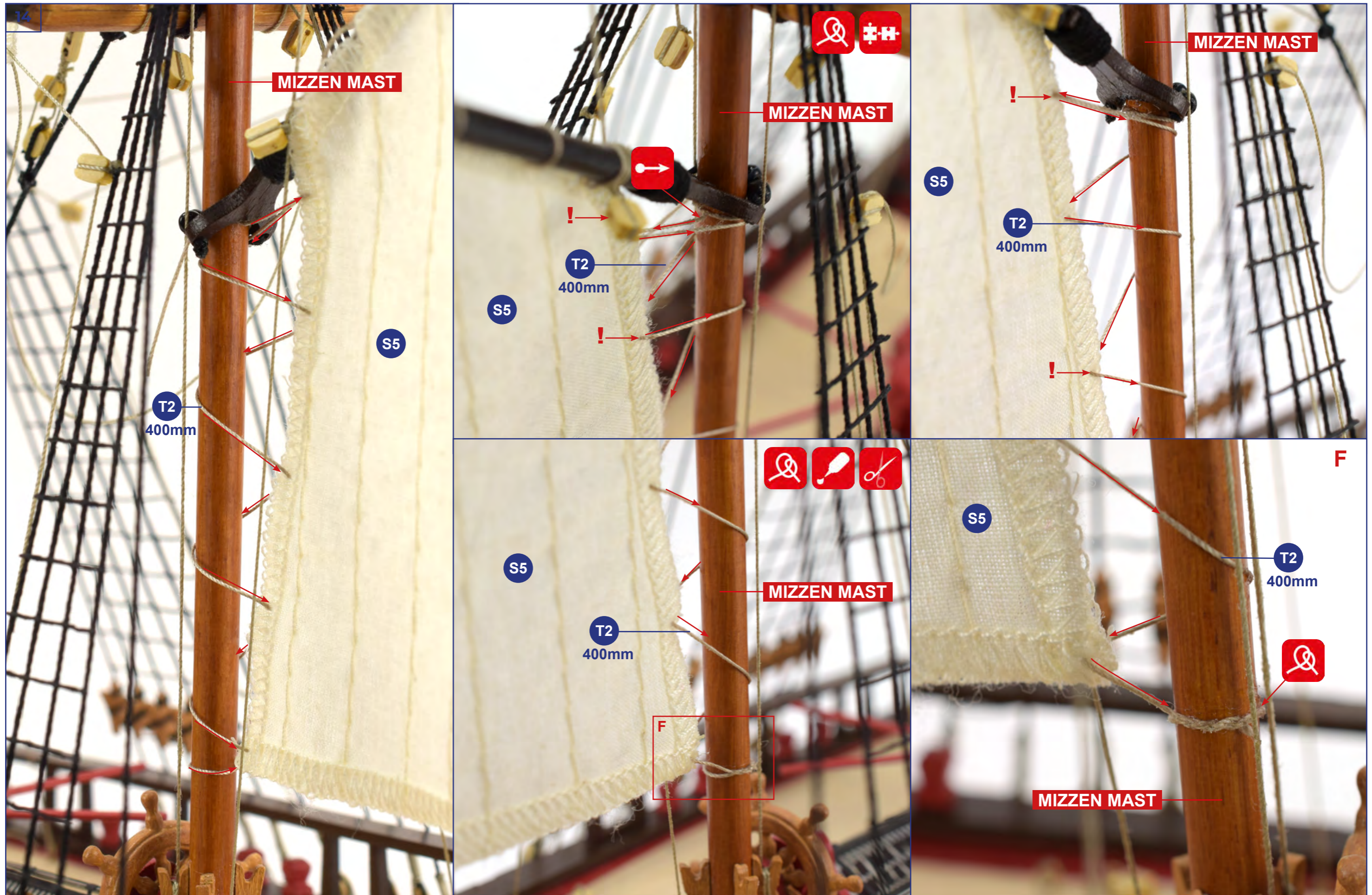

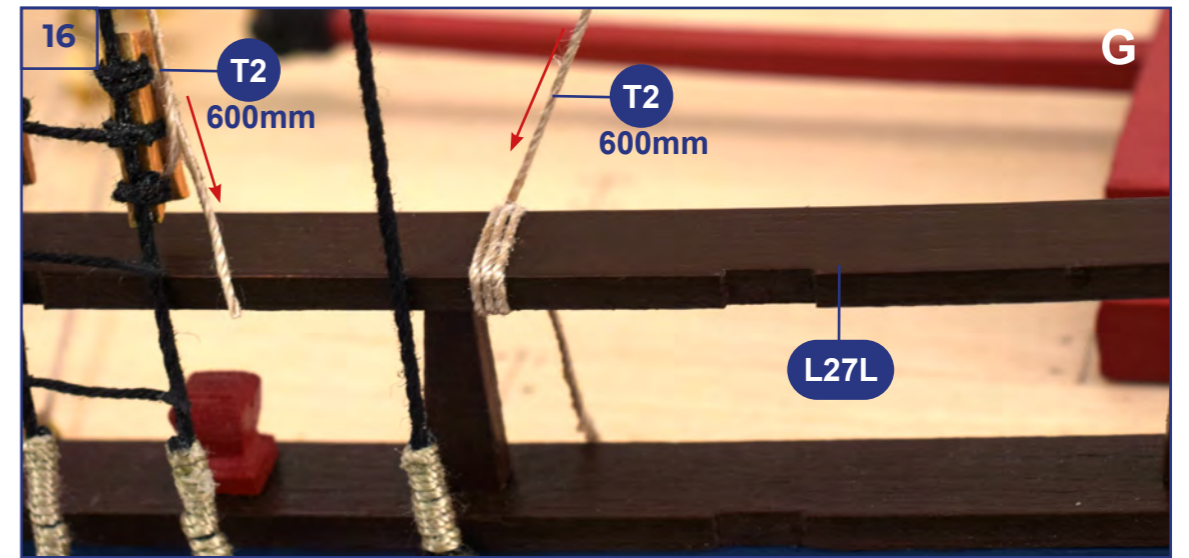
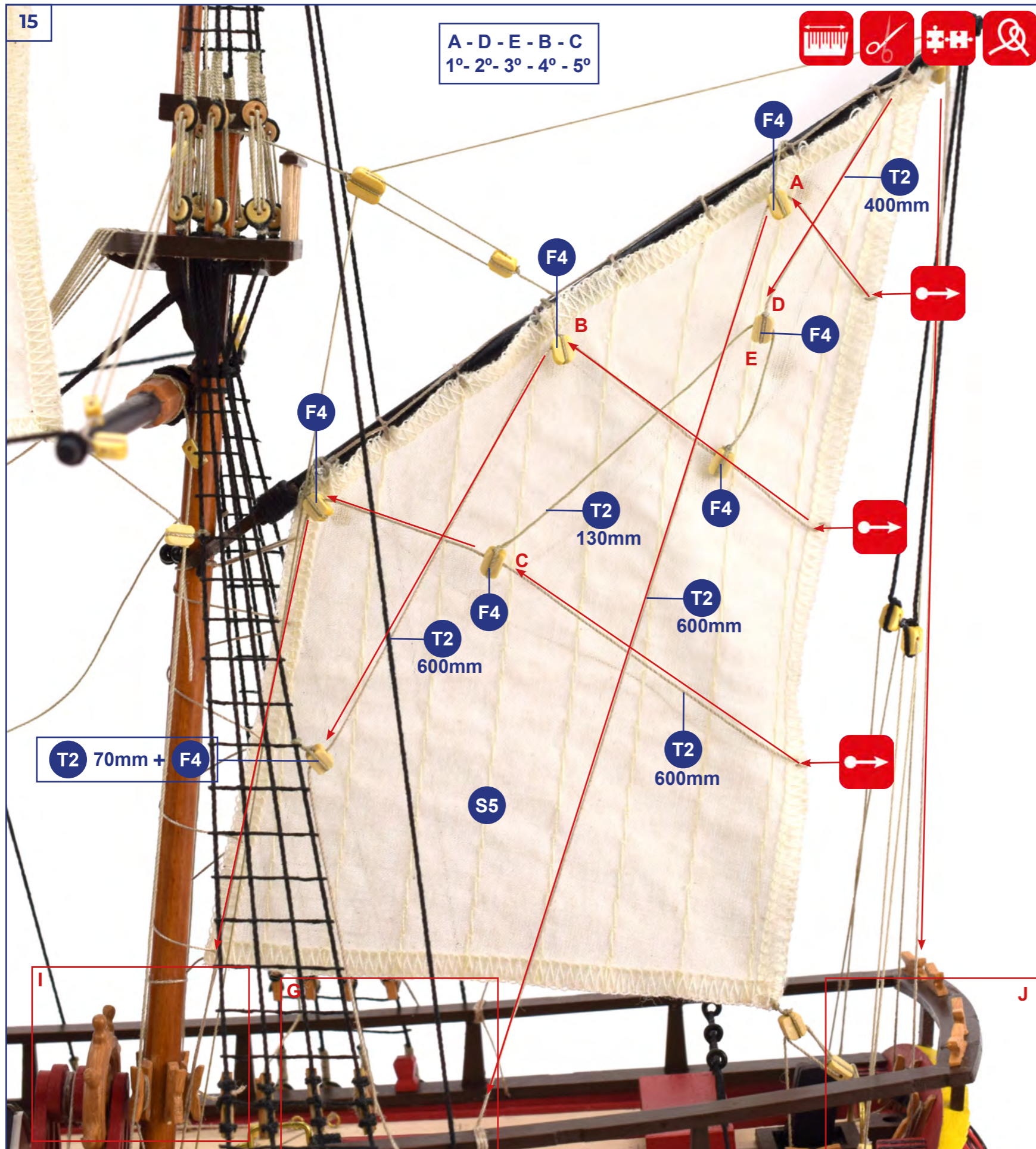

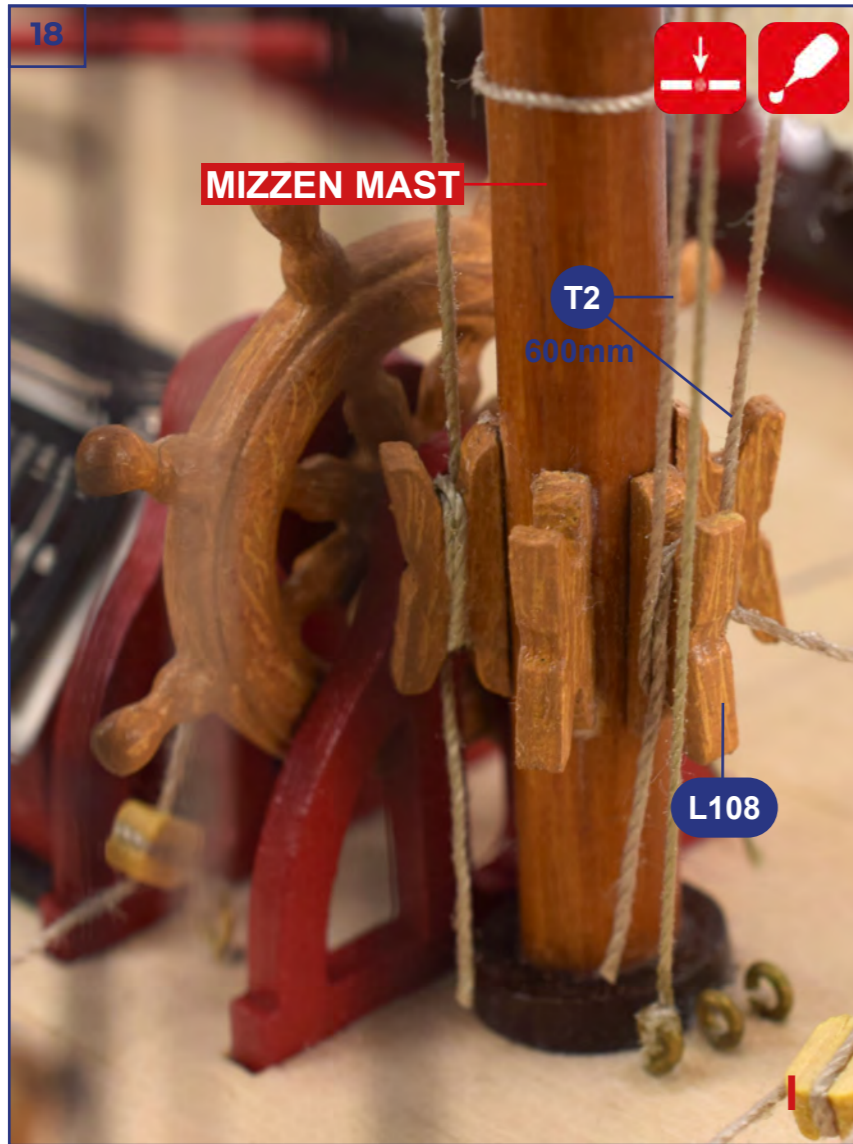

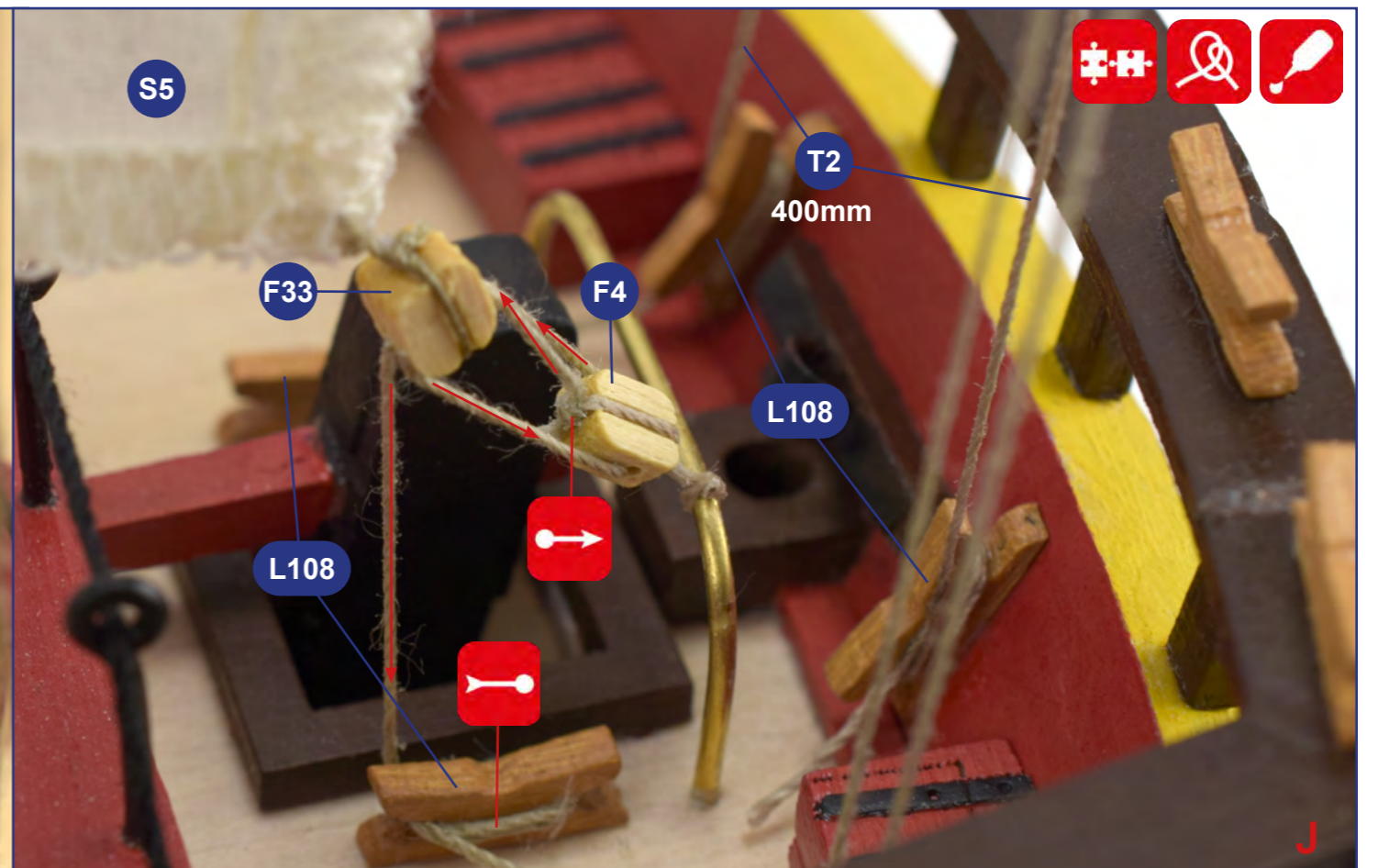
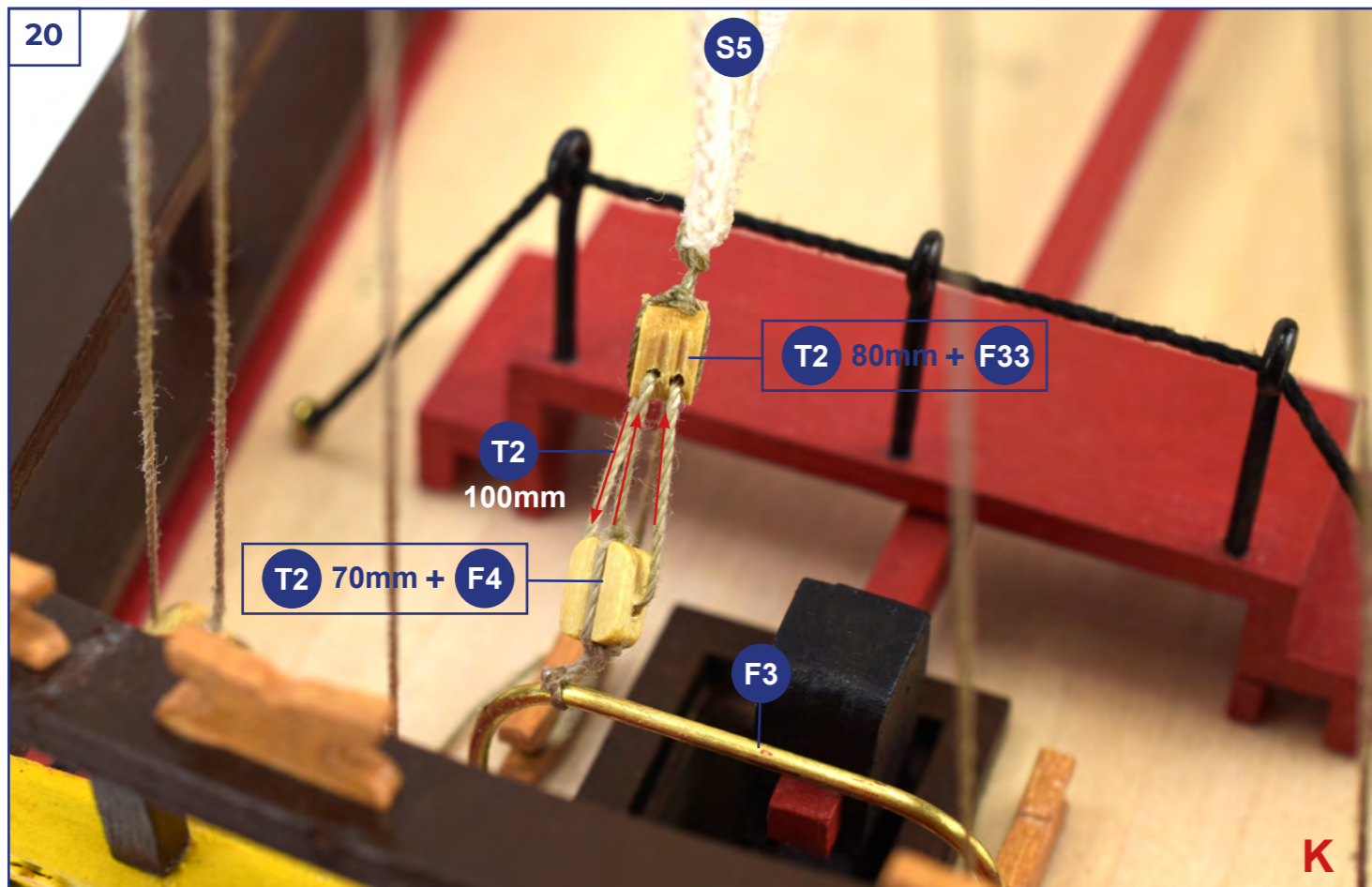
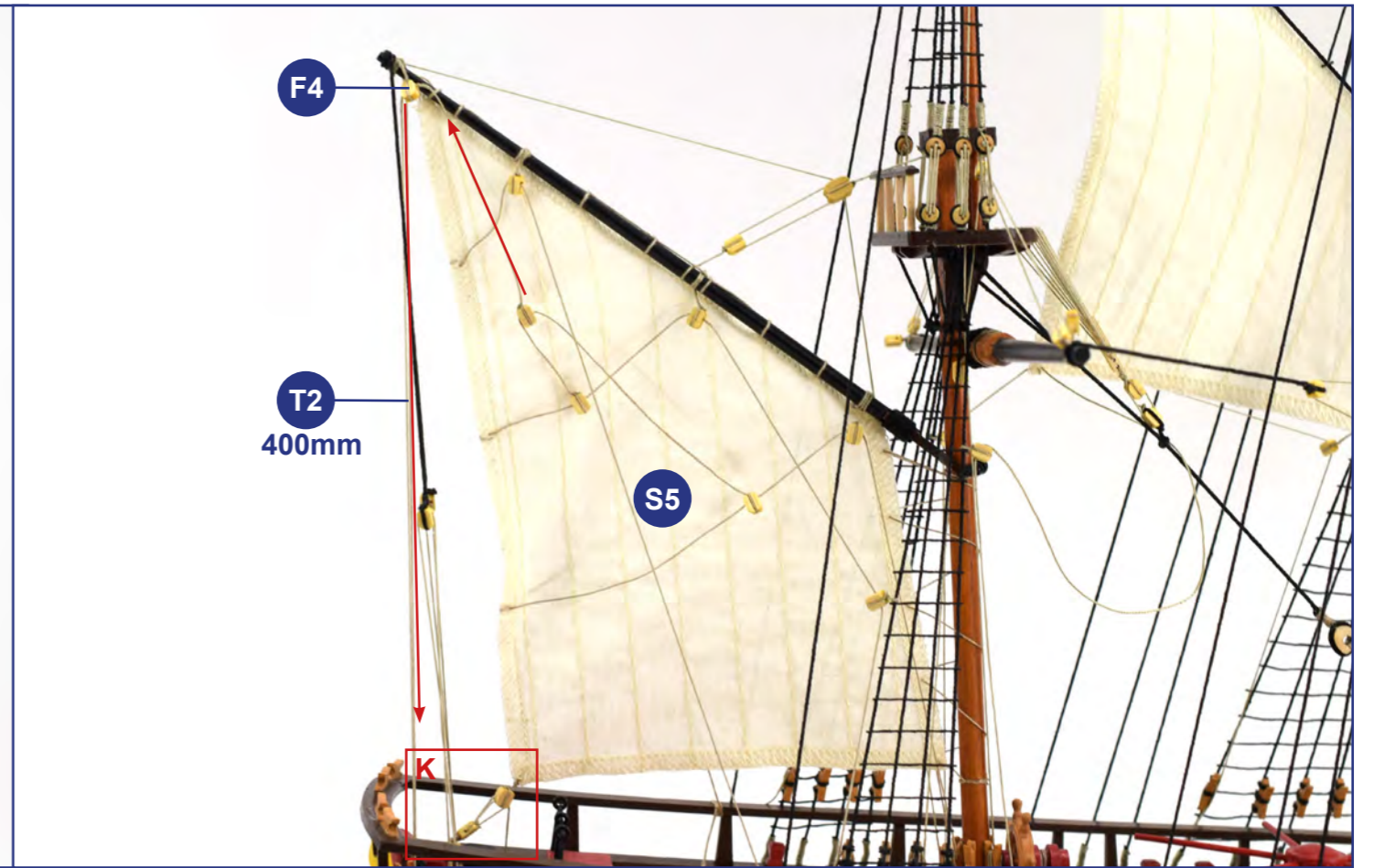
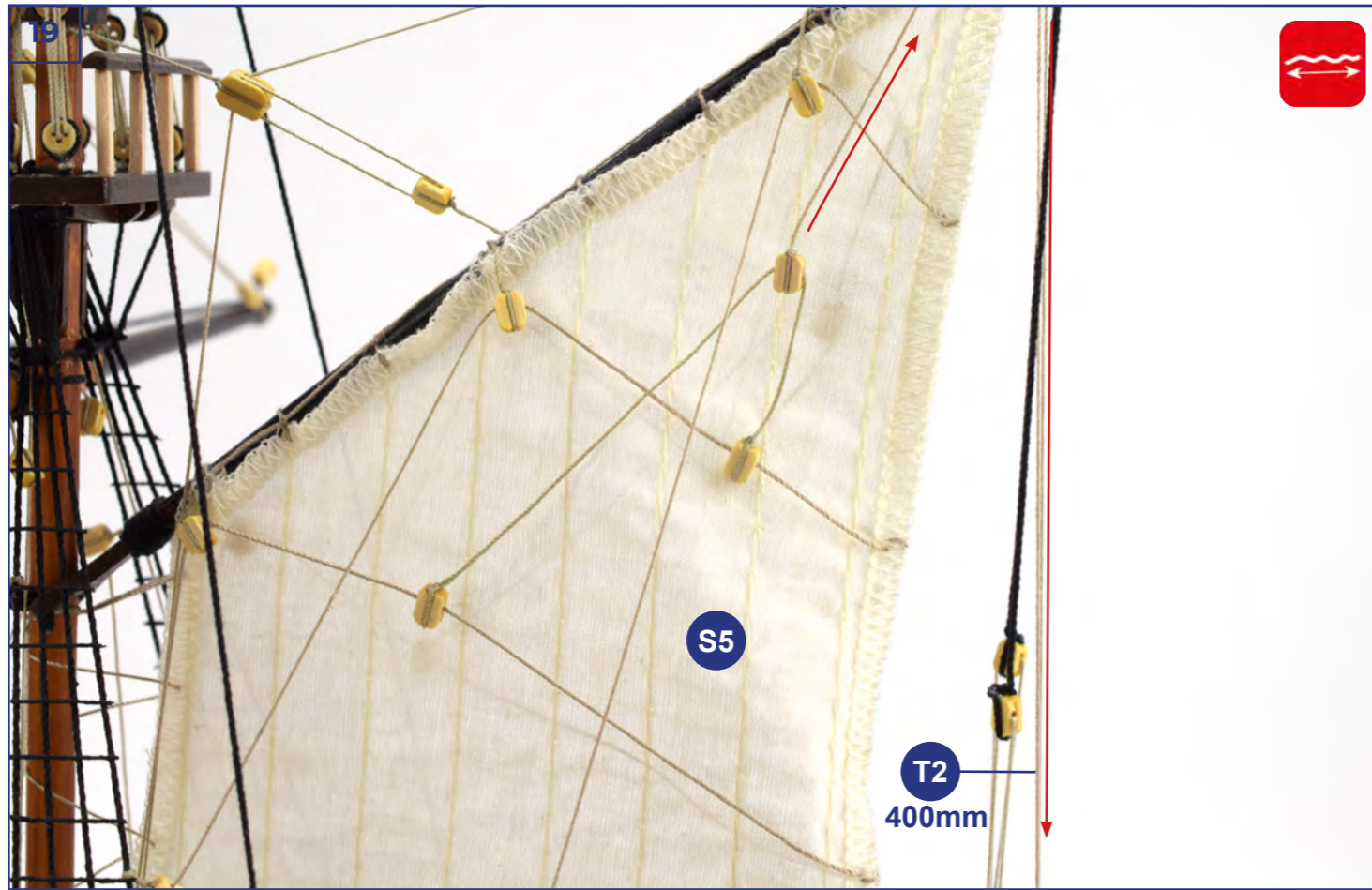

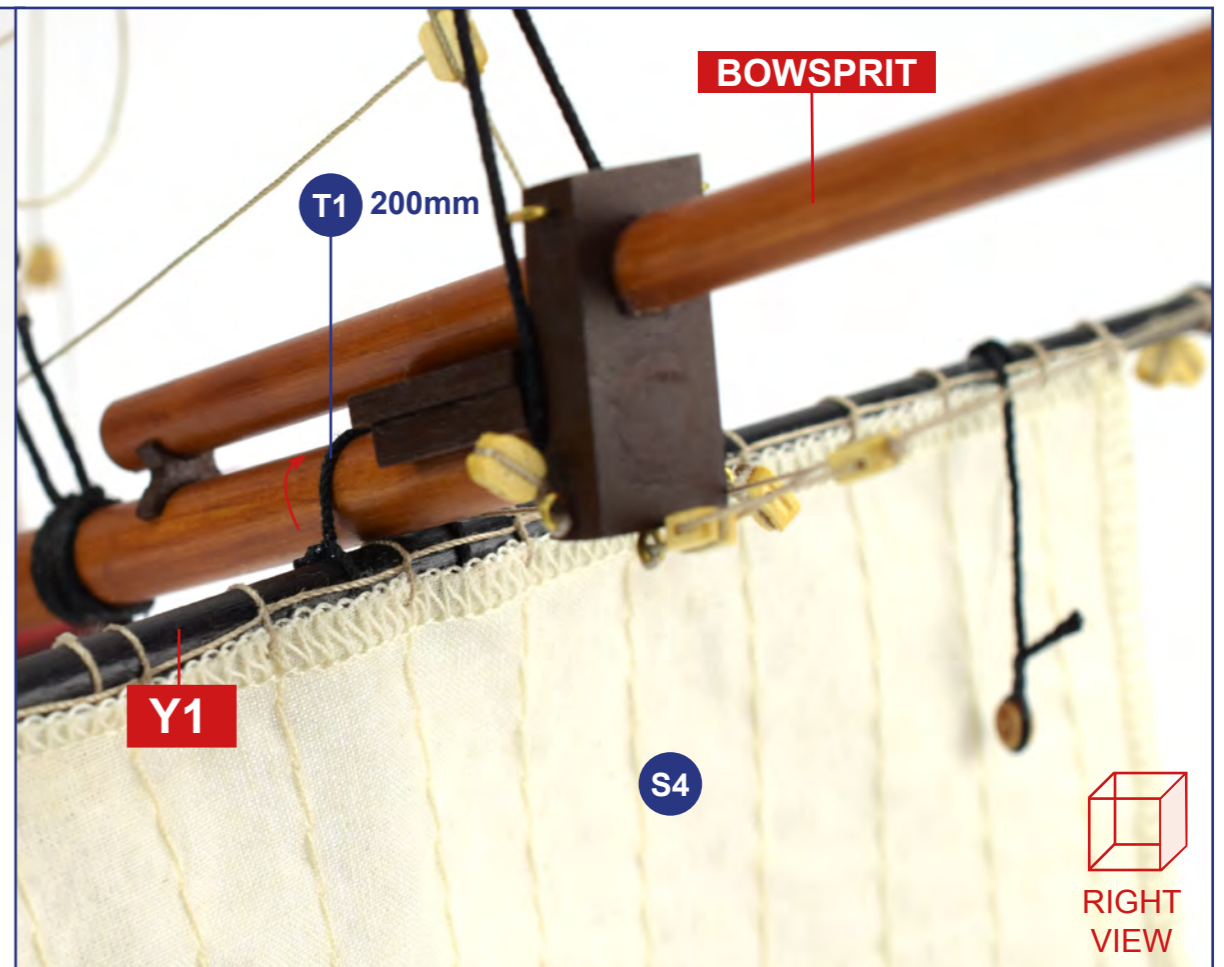
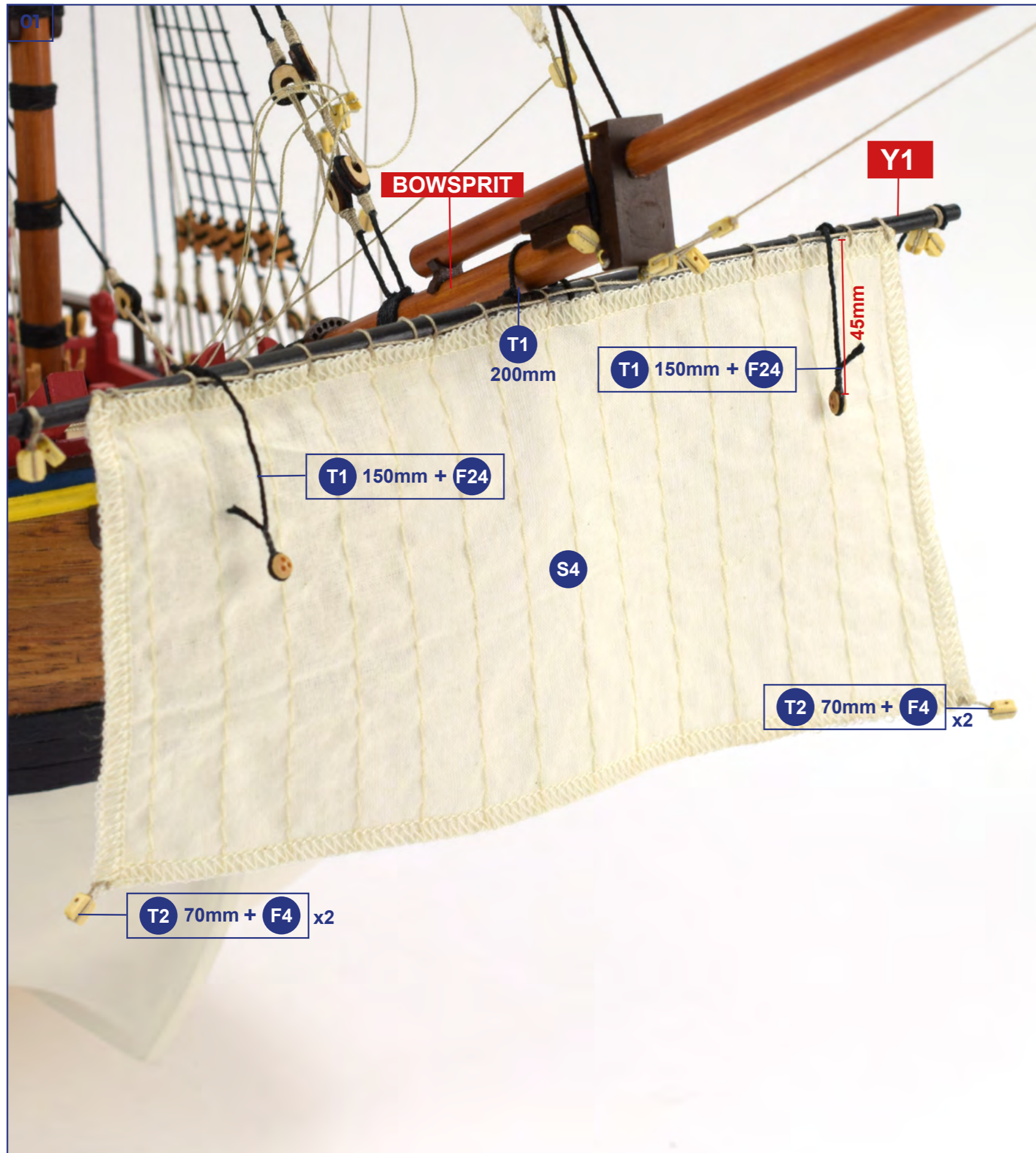

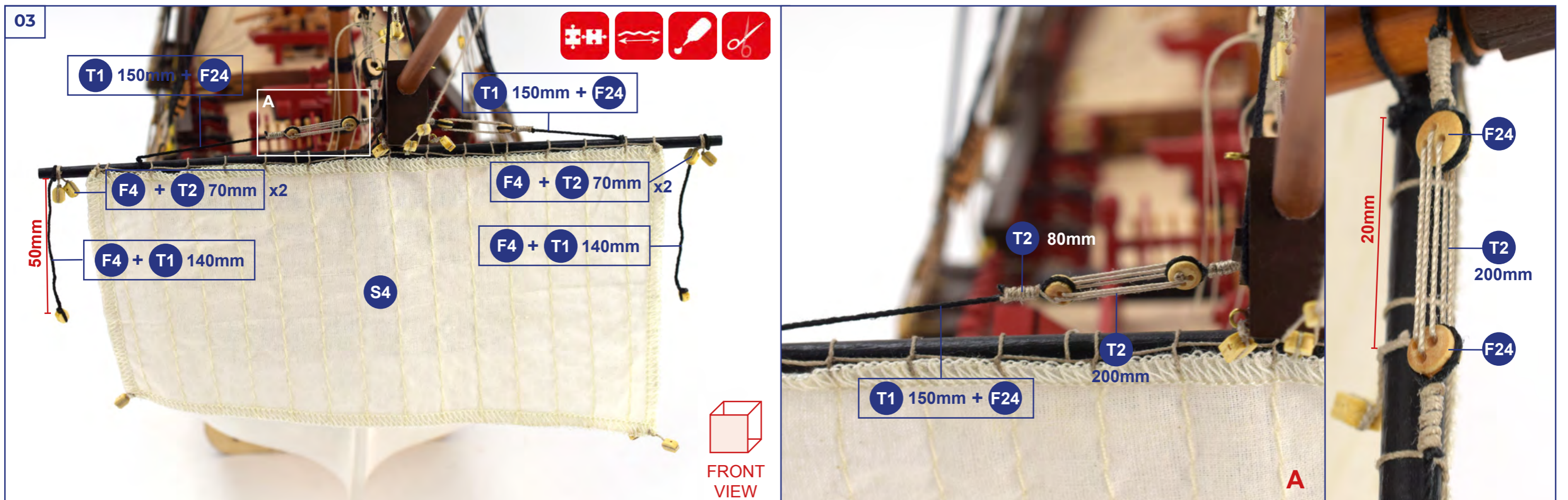
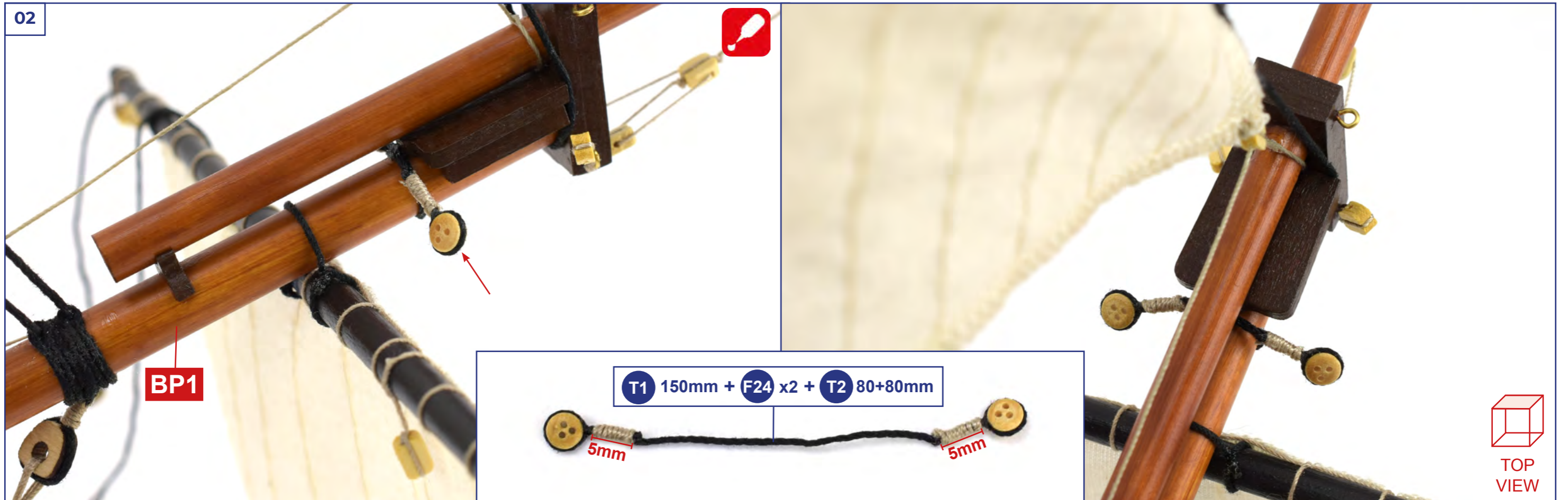

04

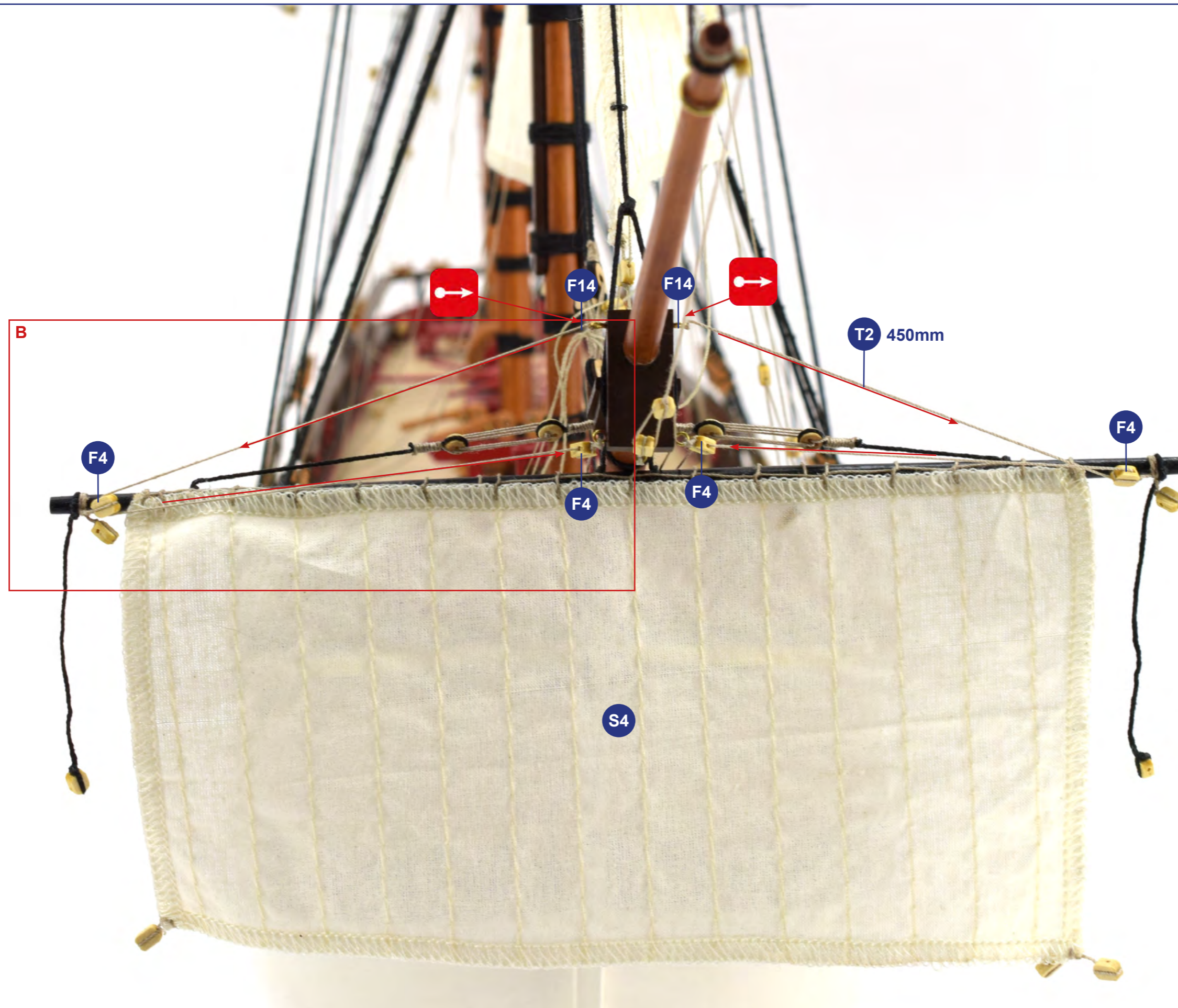

05

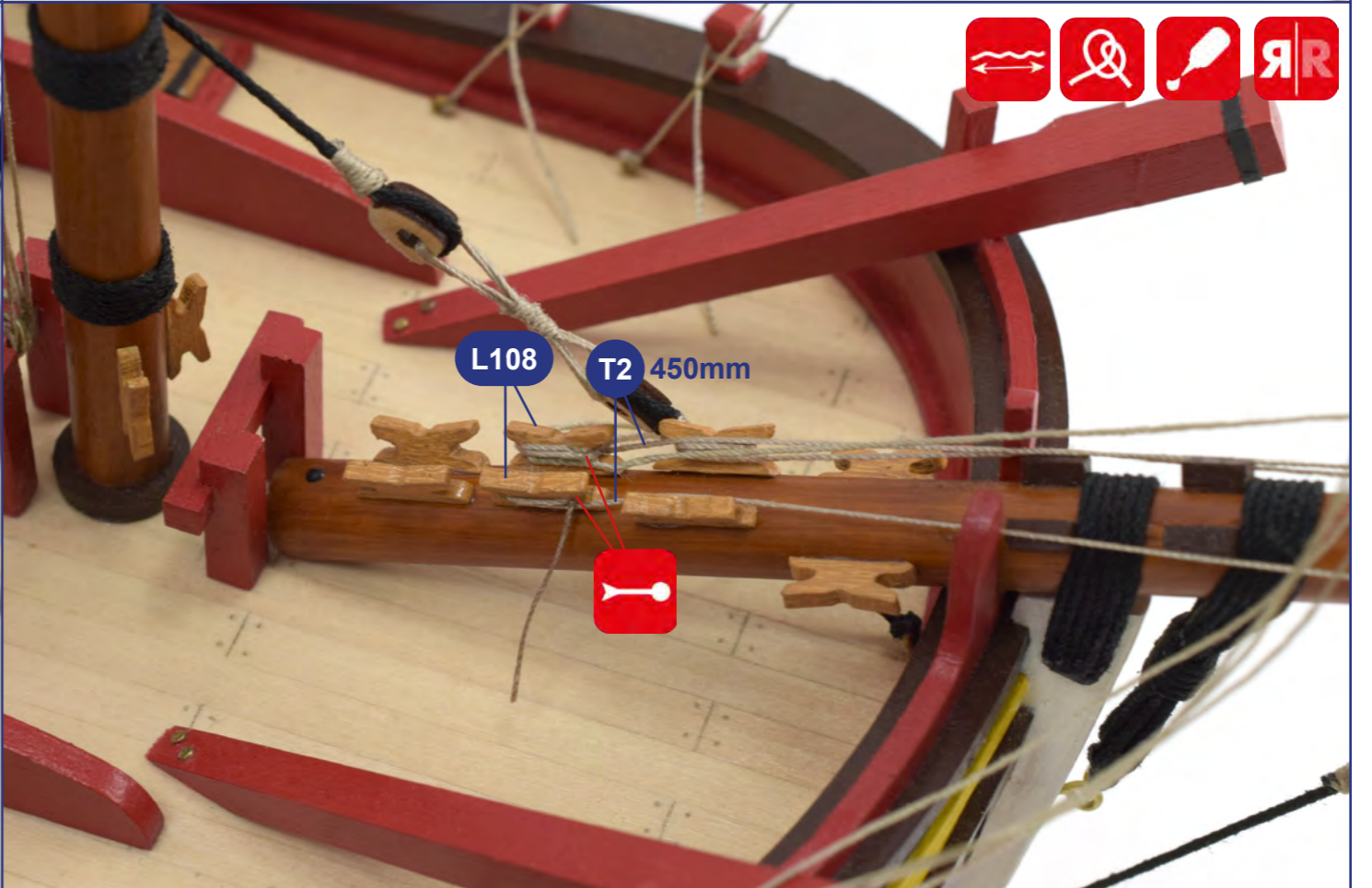
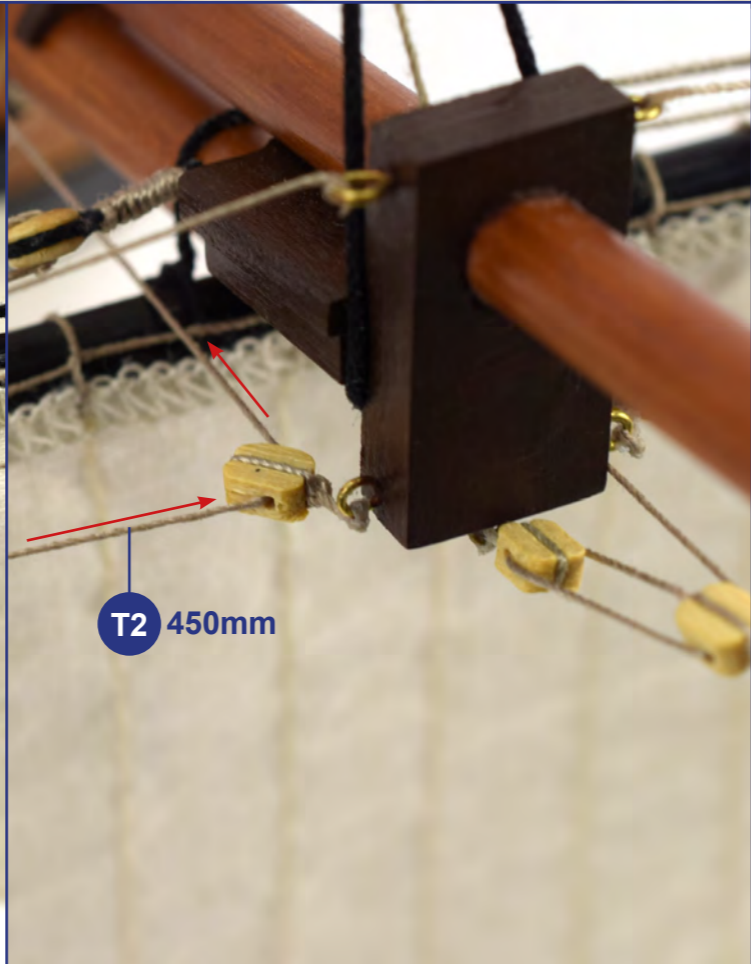
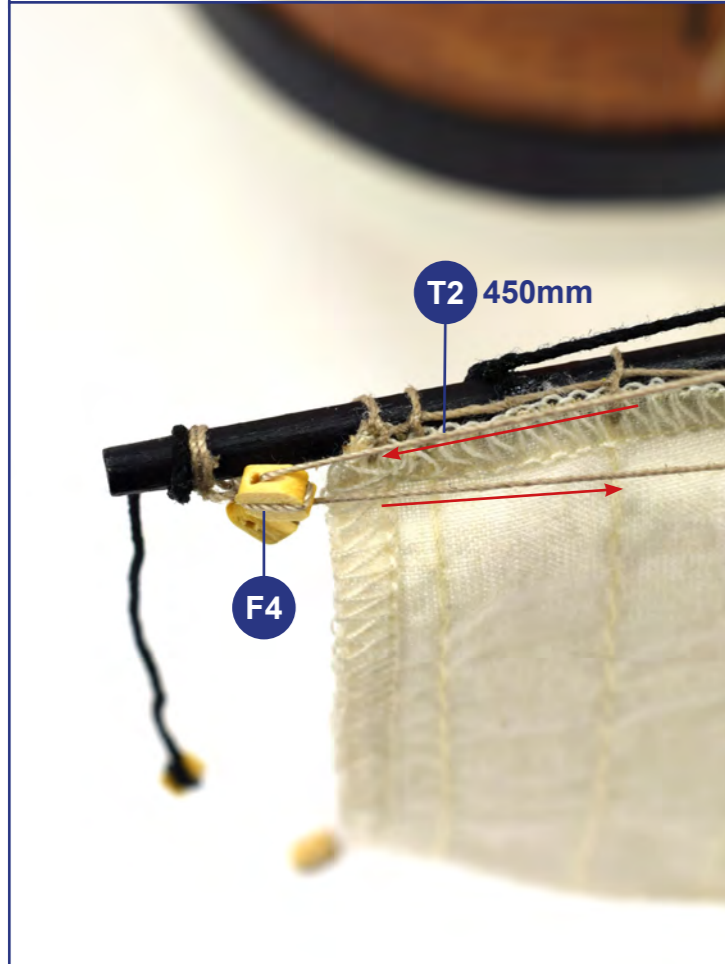
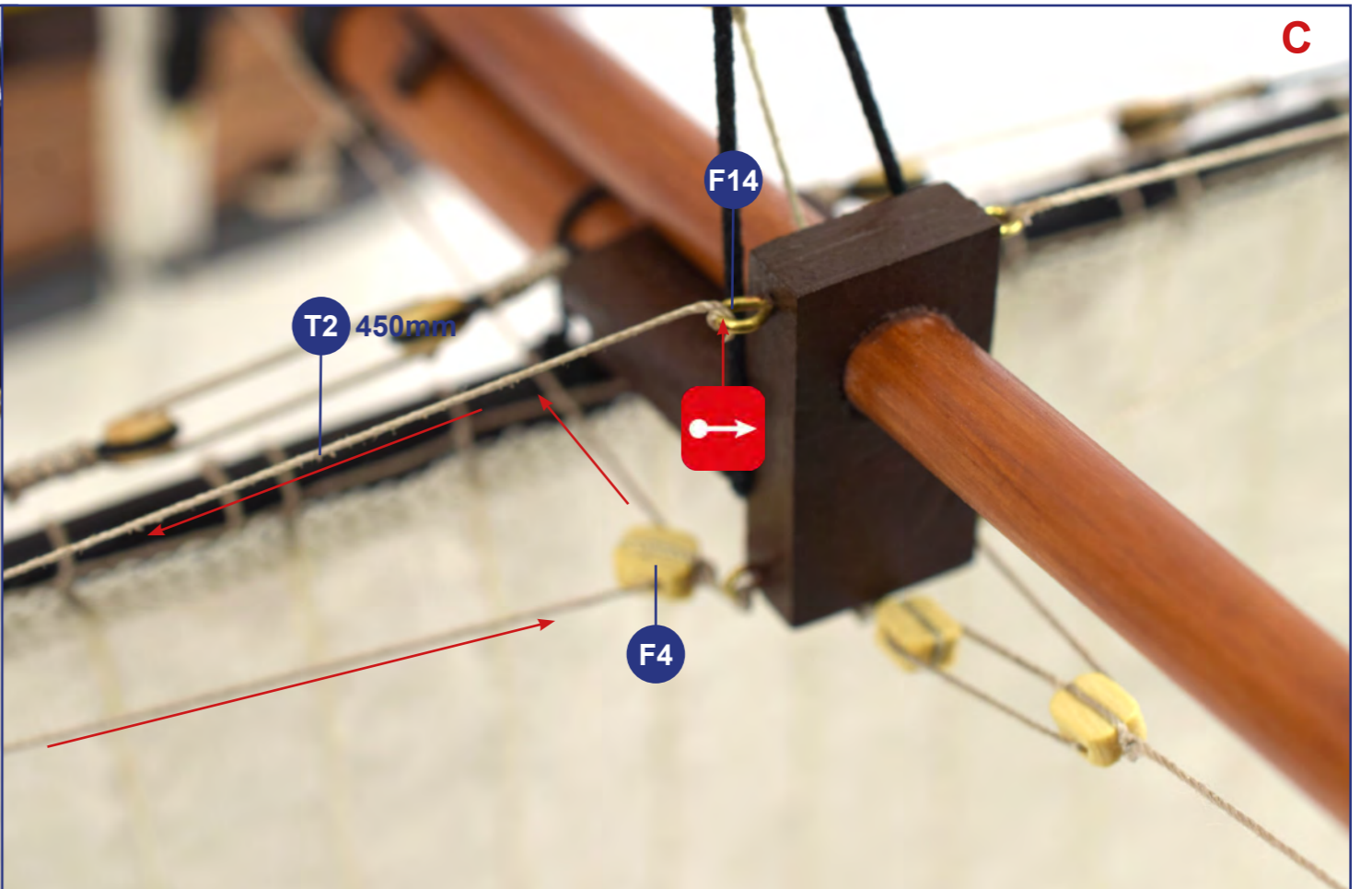
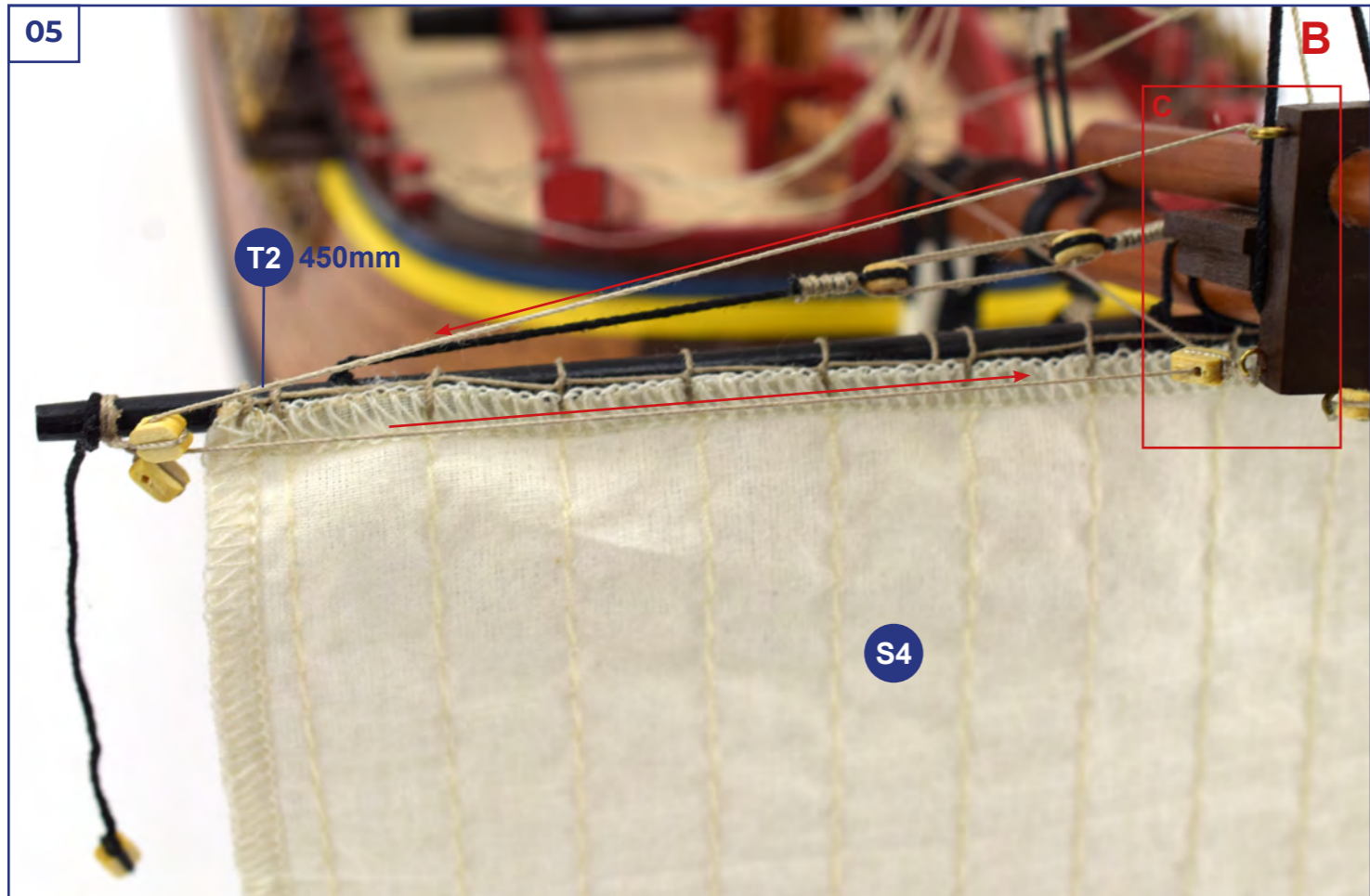

06

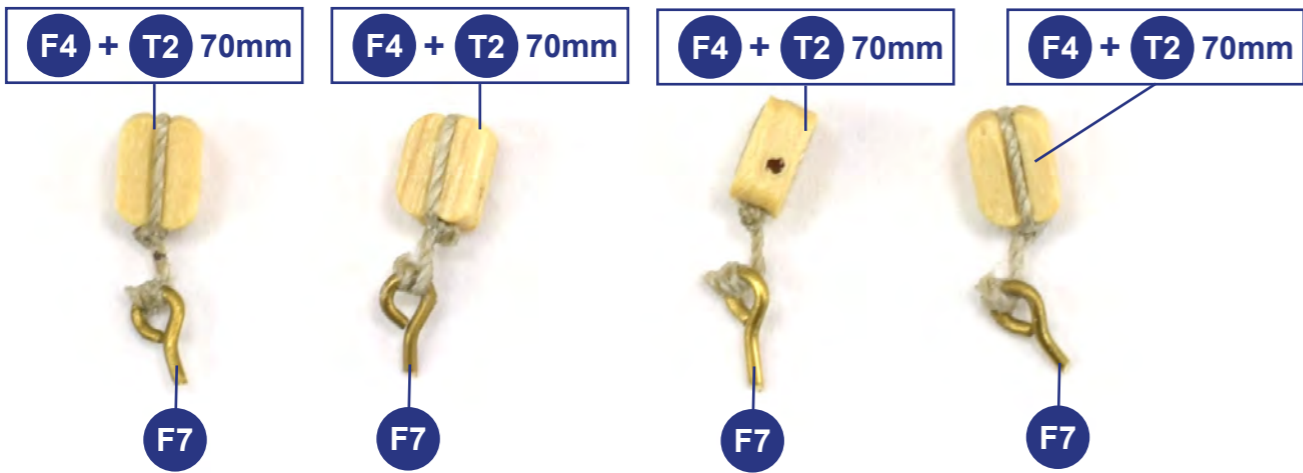

07



08

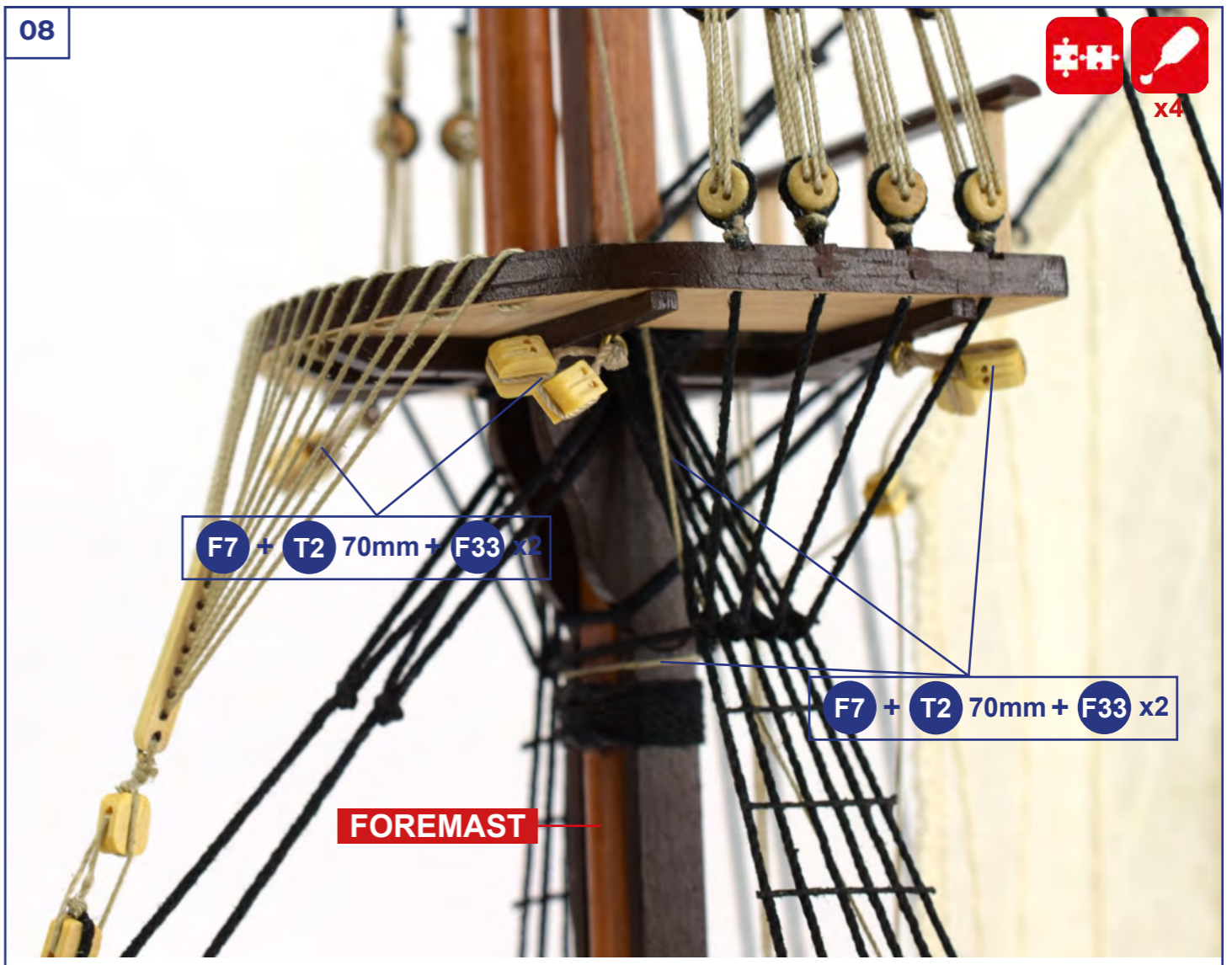

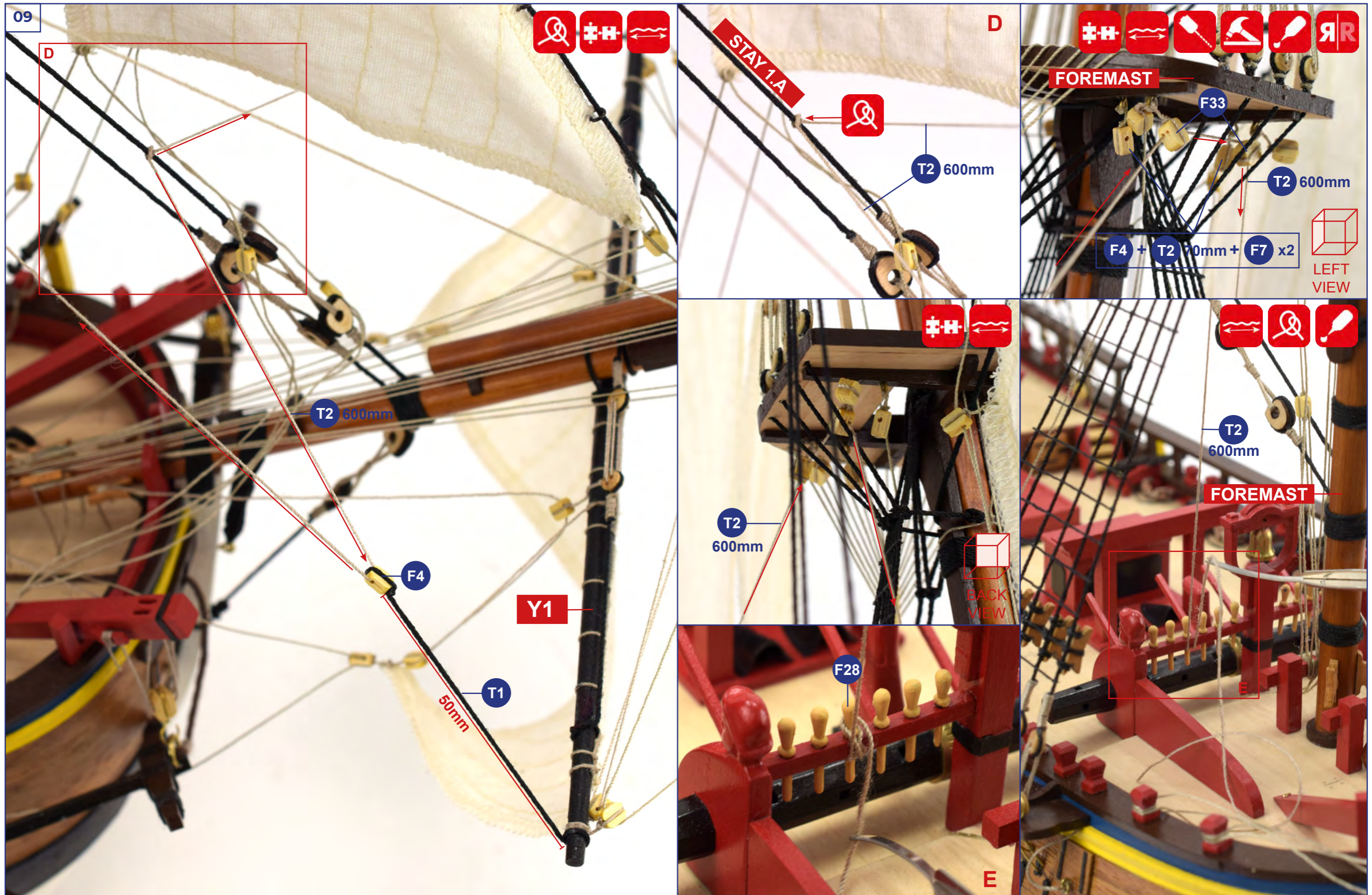

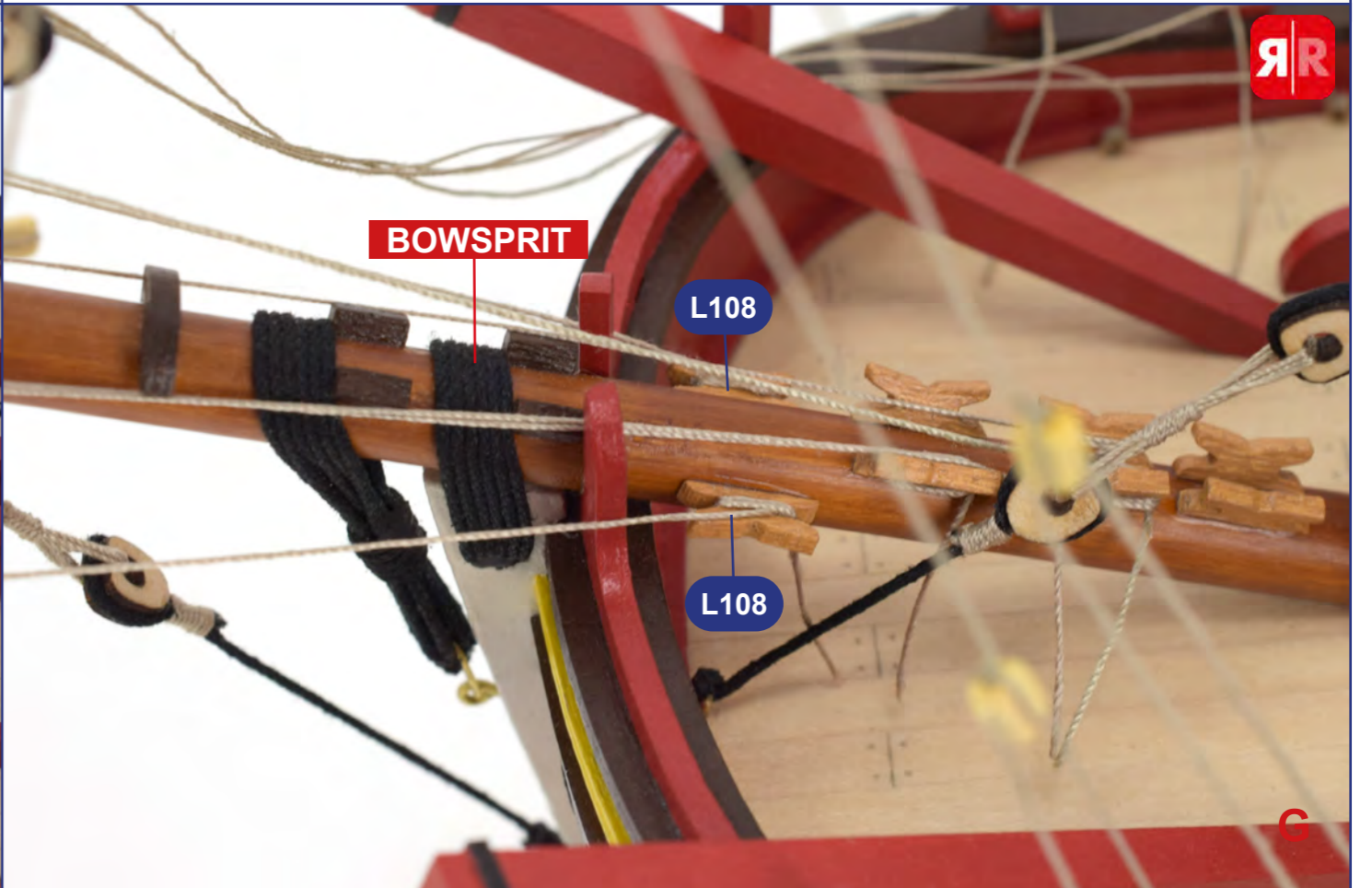
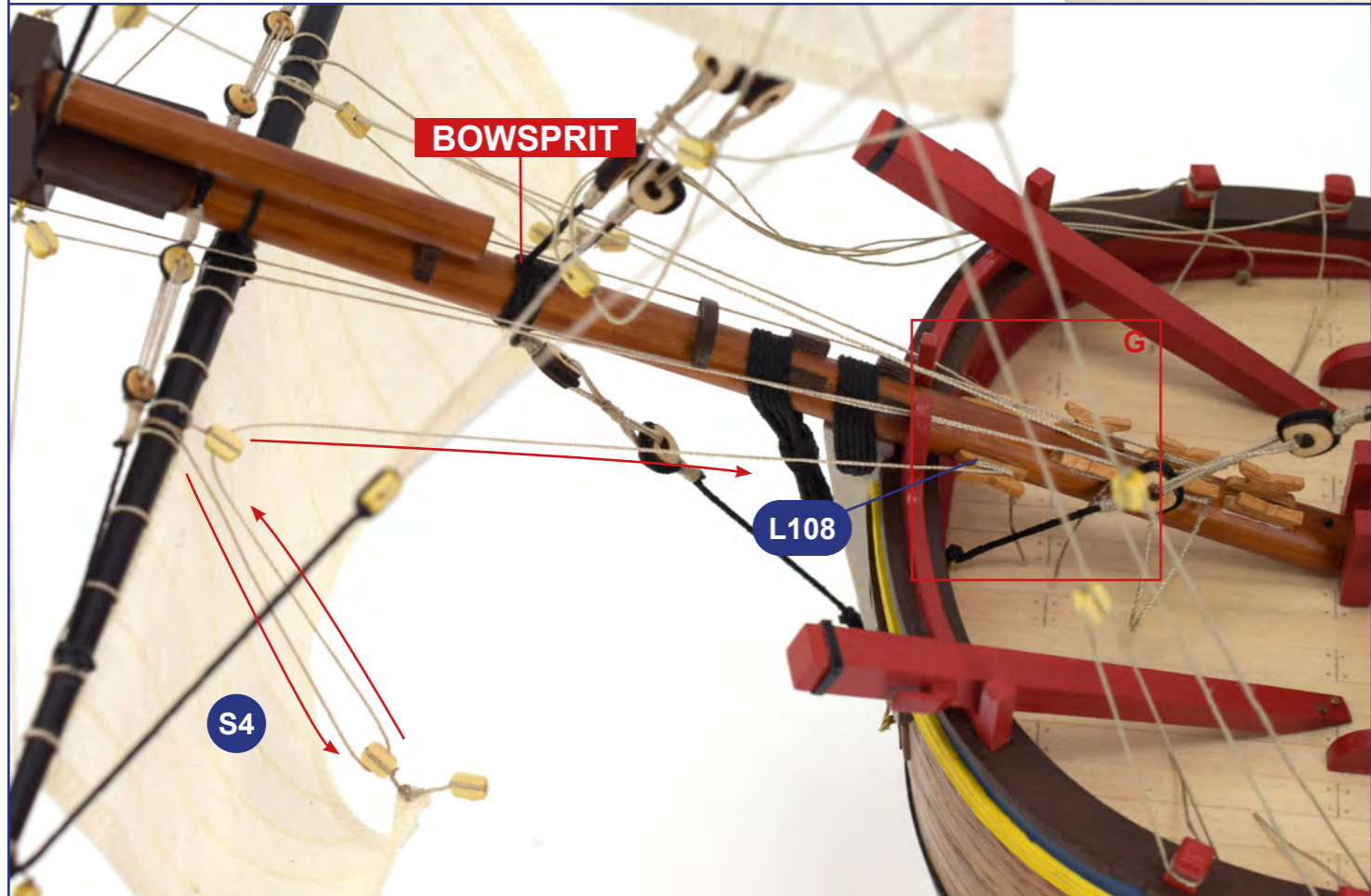
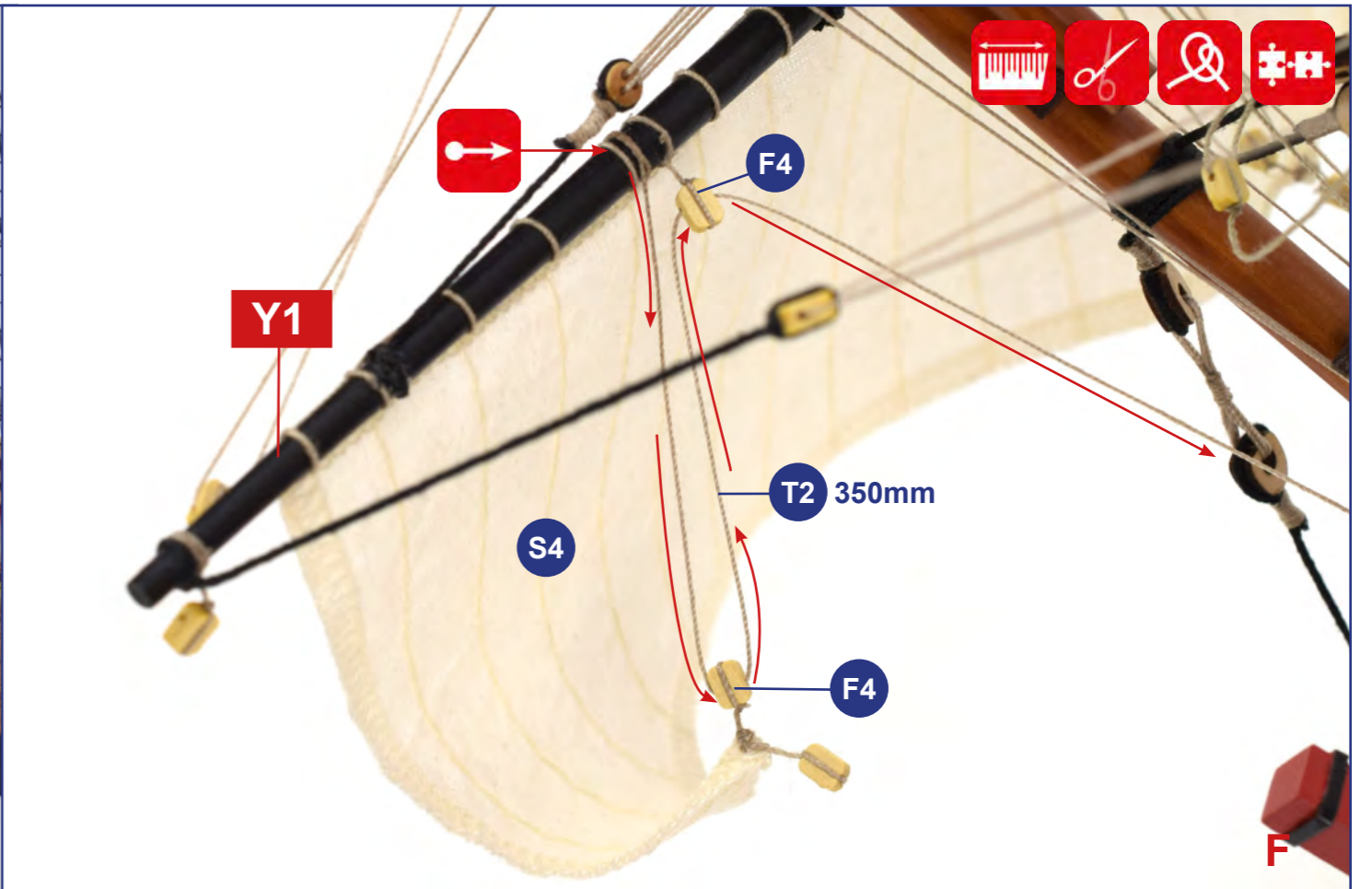

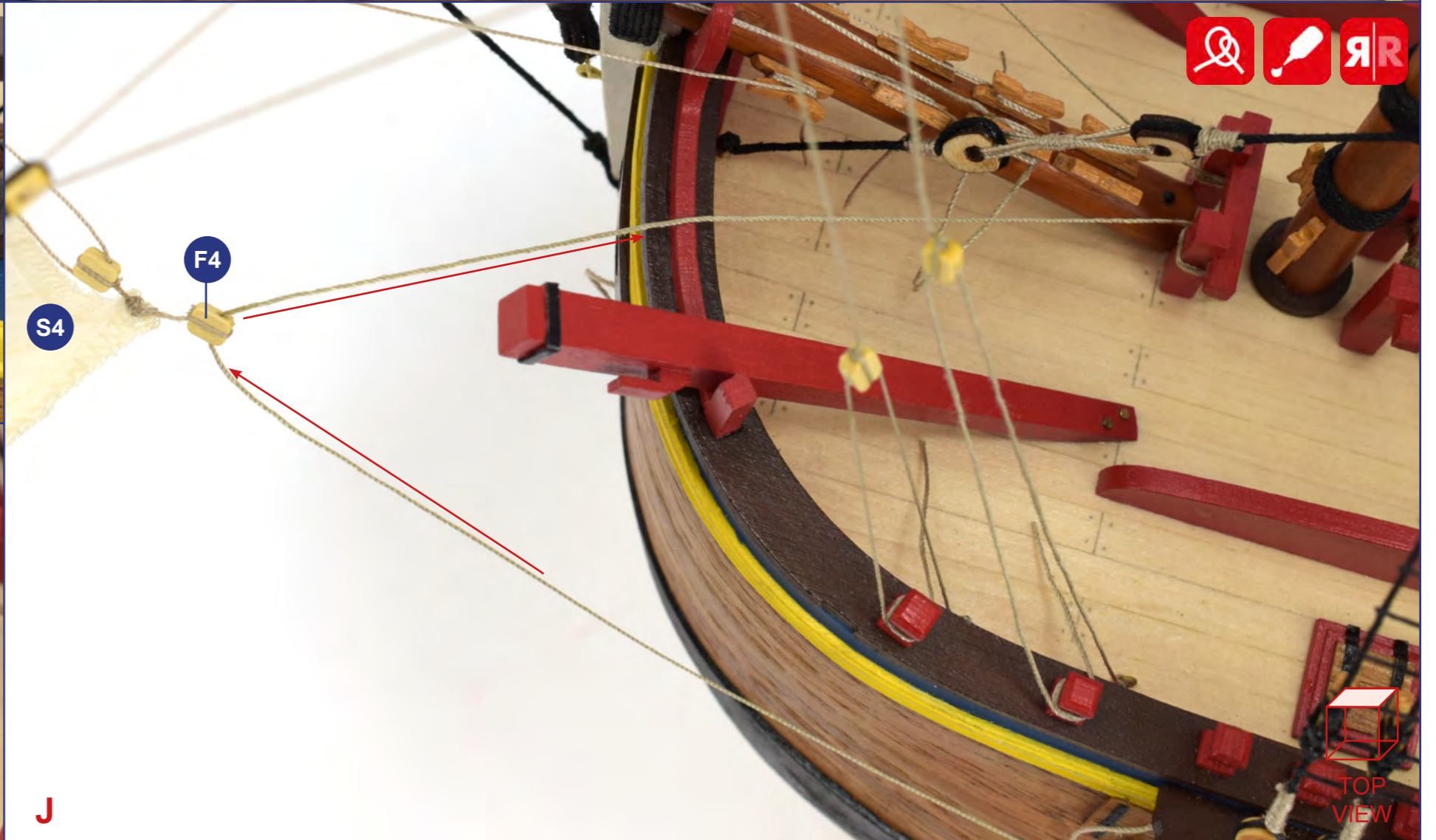
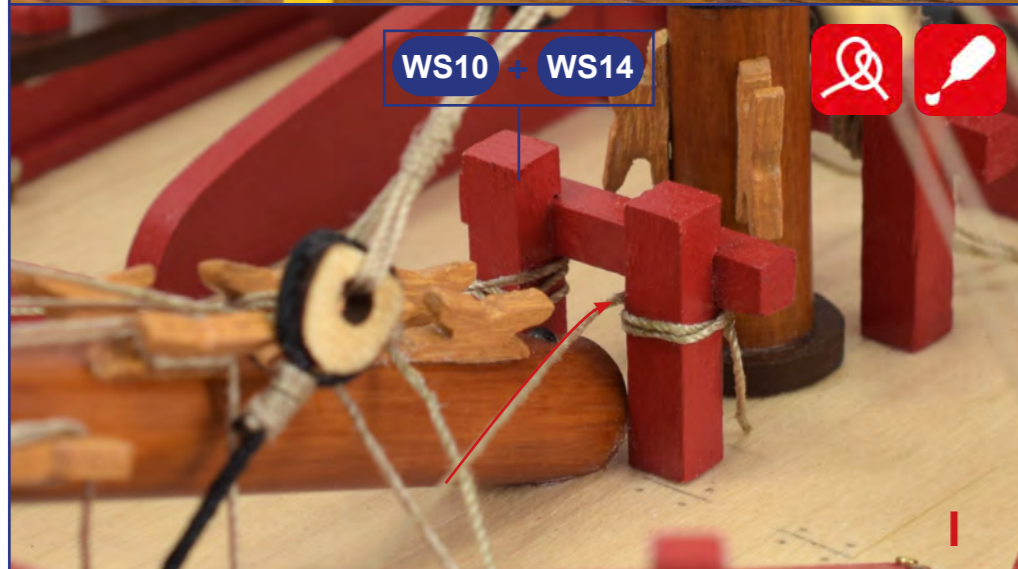
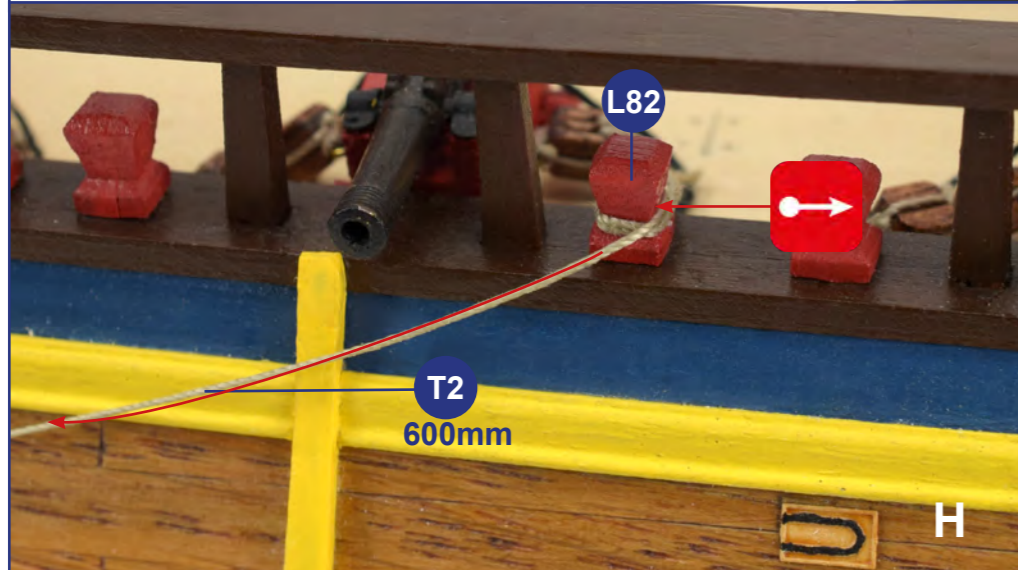

01

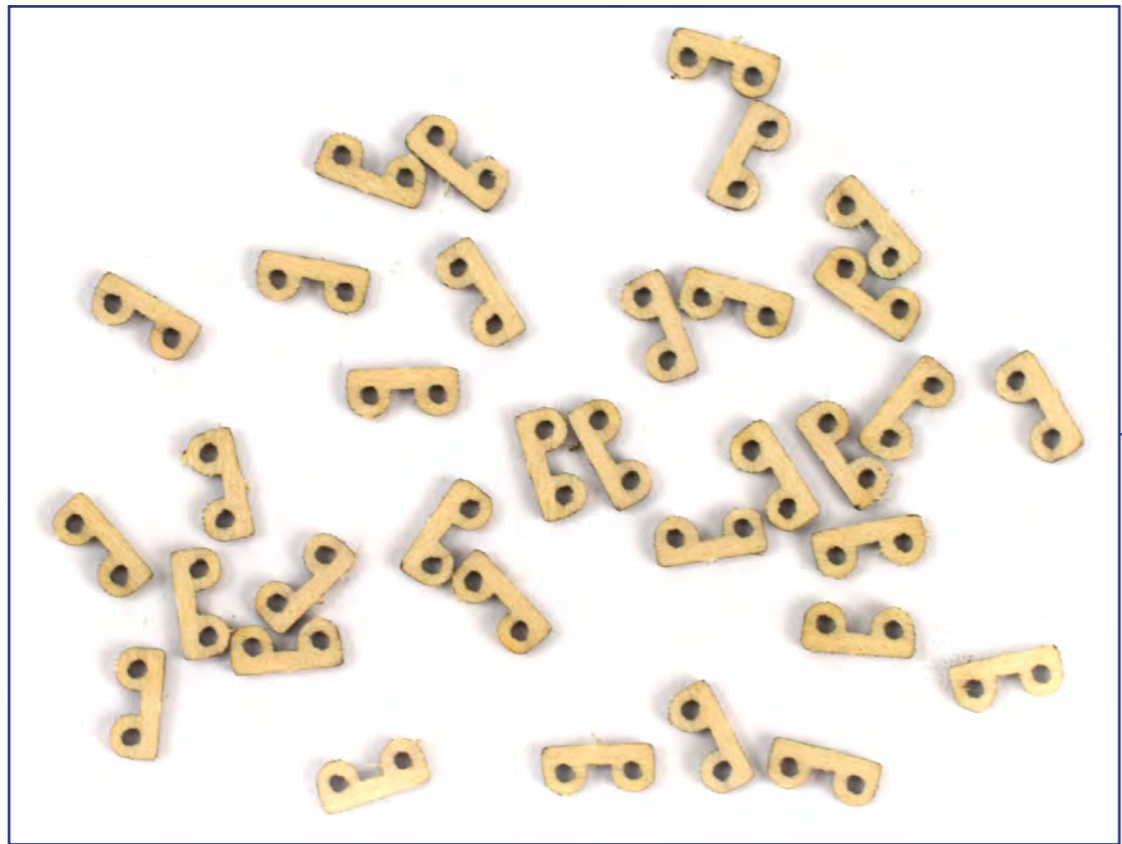

L144

02

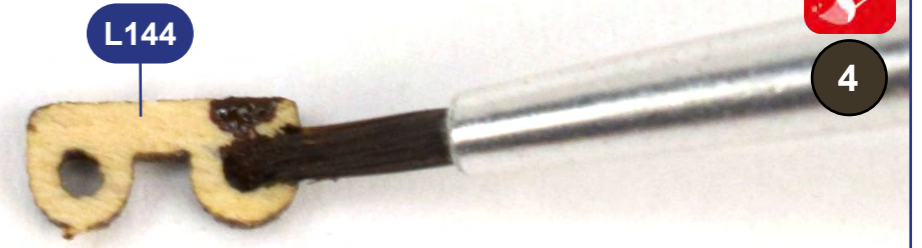

L144



4

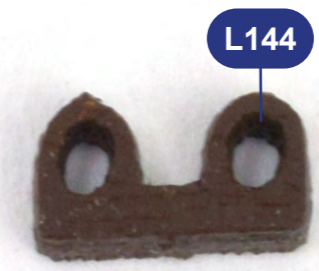

L144



x27

03



F32



T1



L144

04

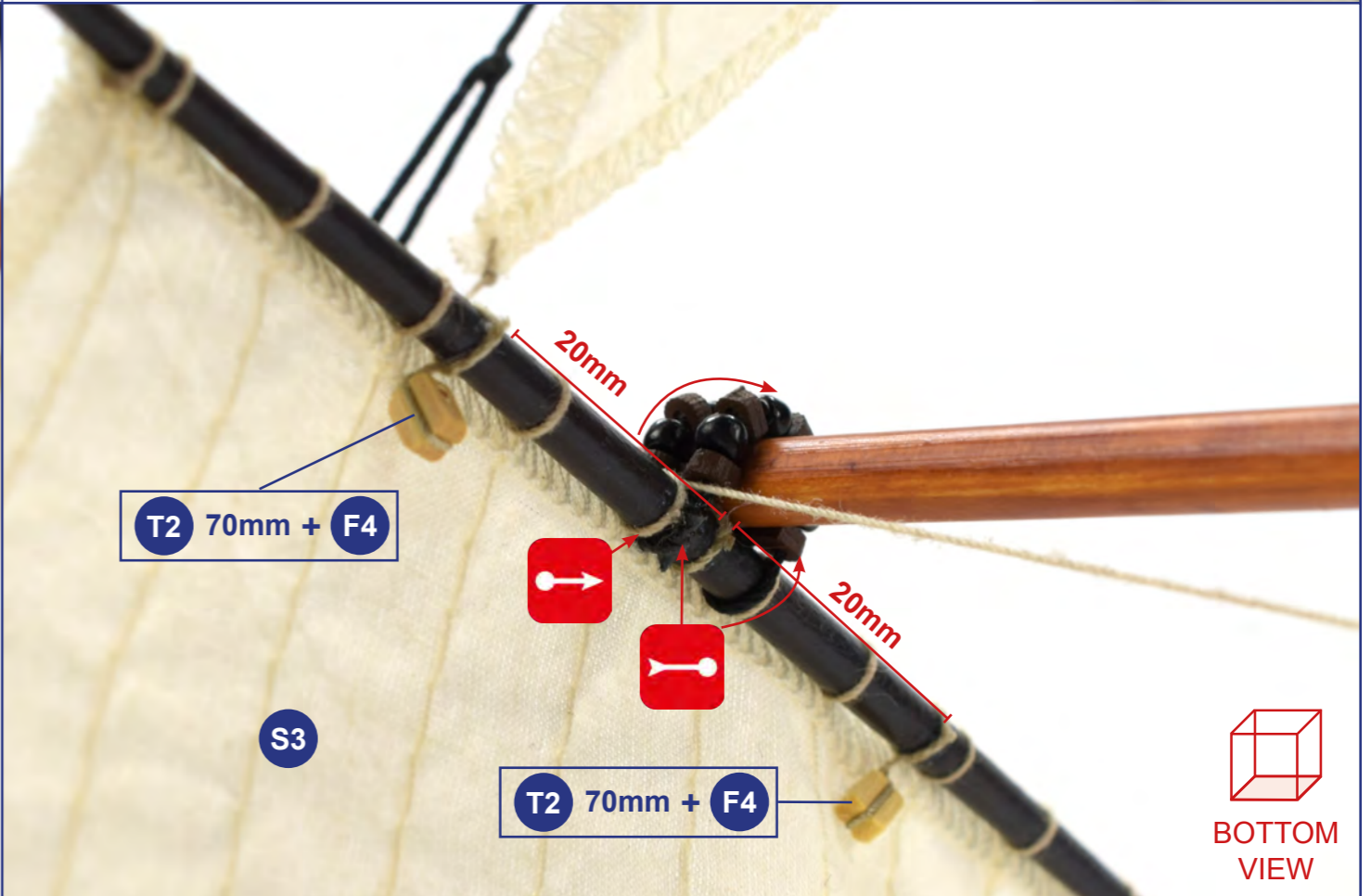
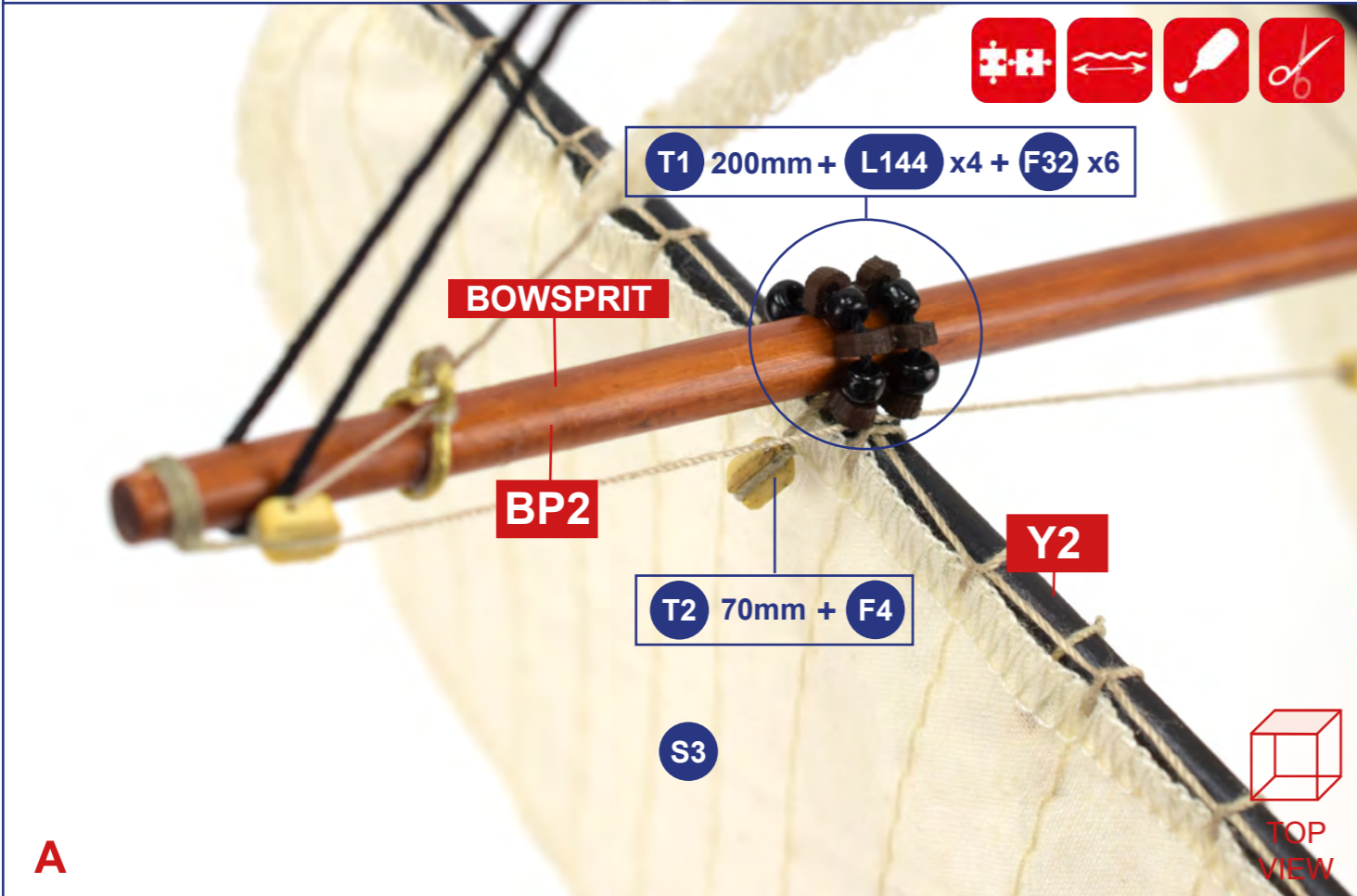
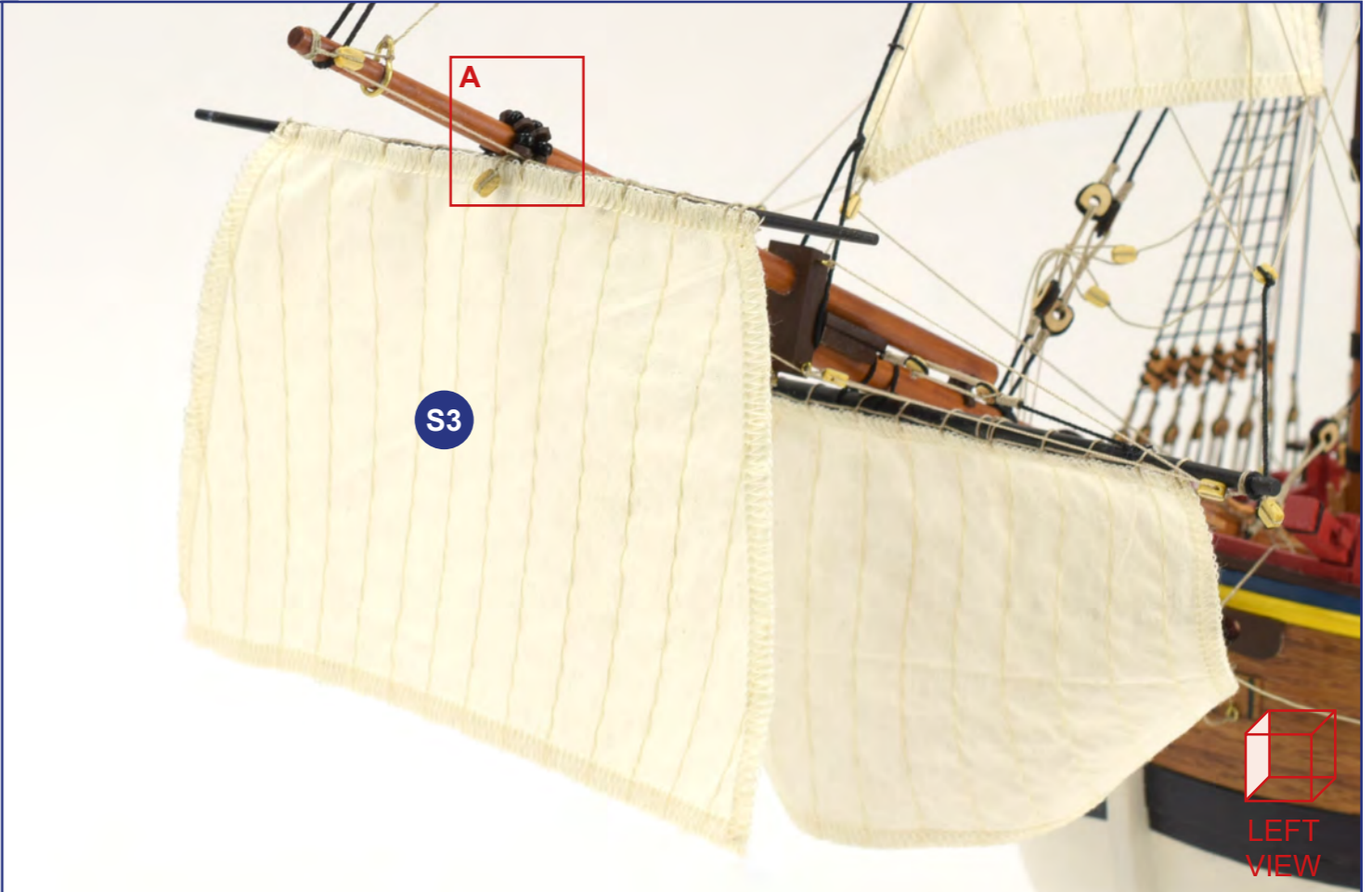

A

05

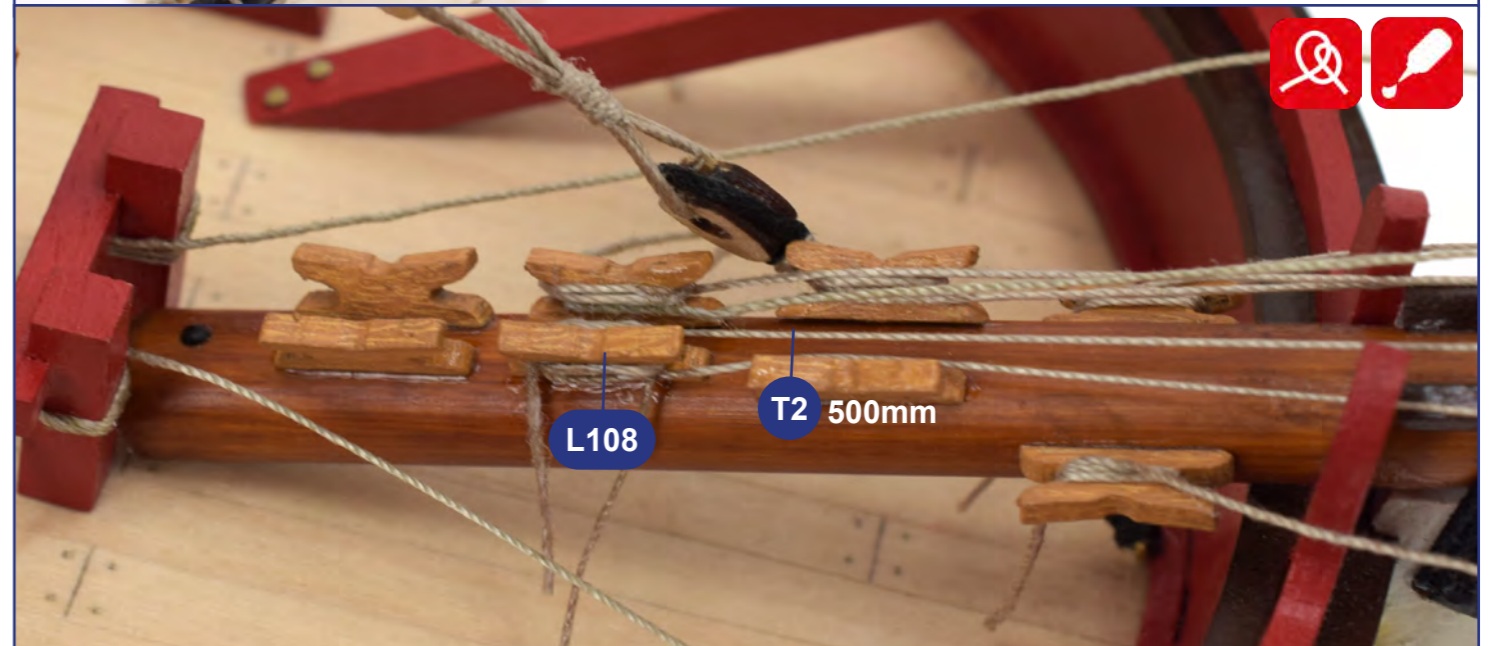
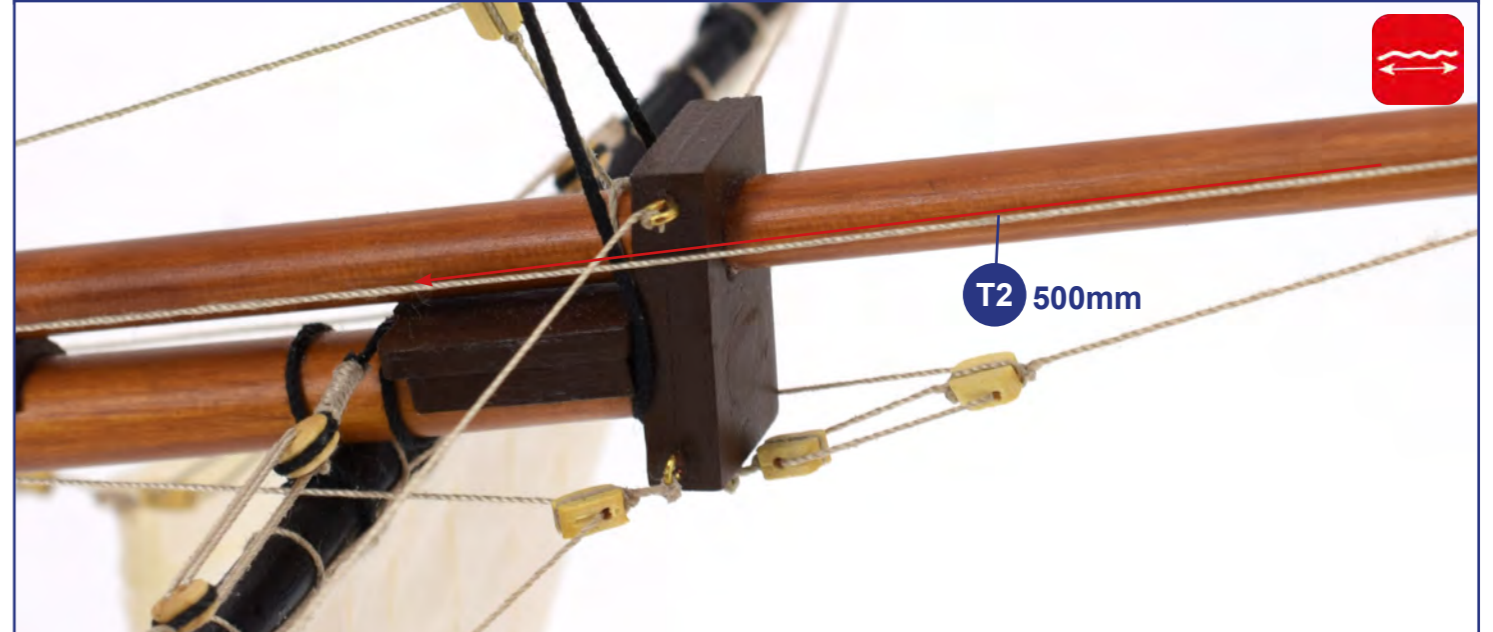
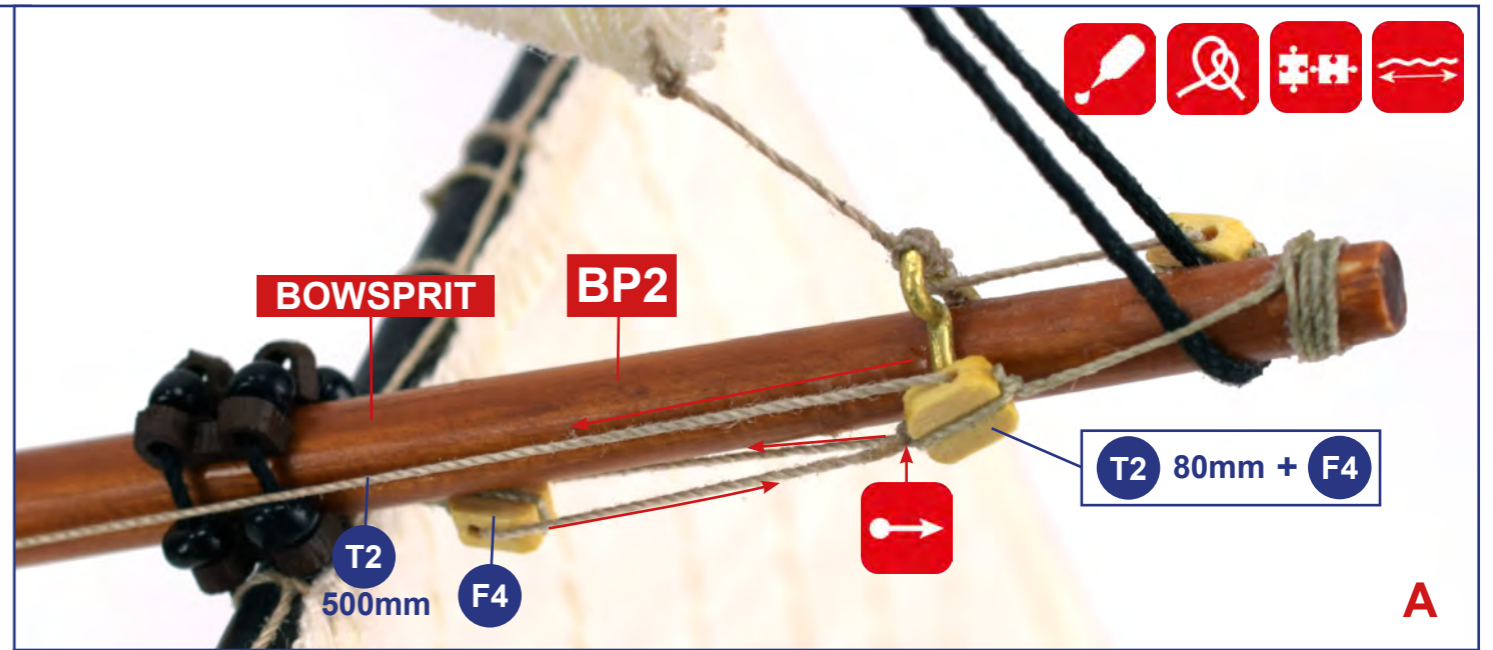
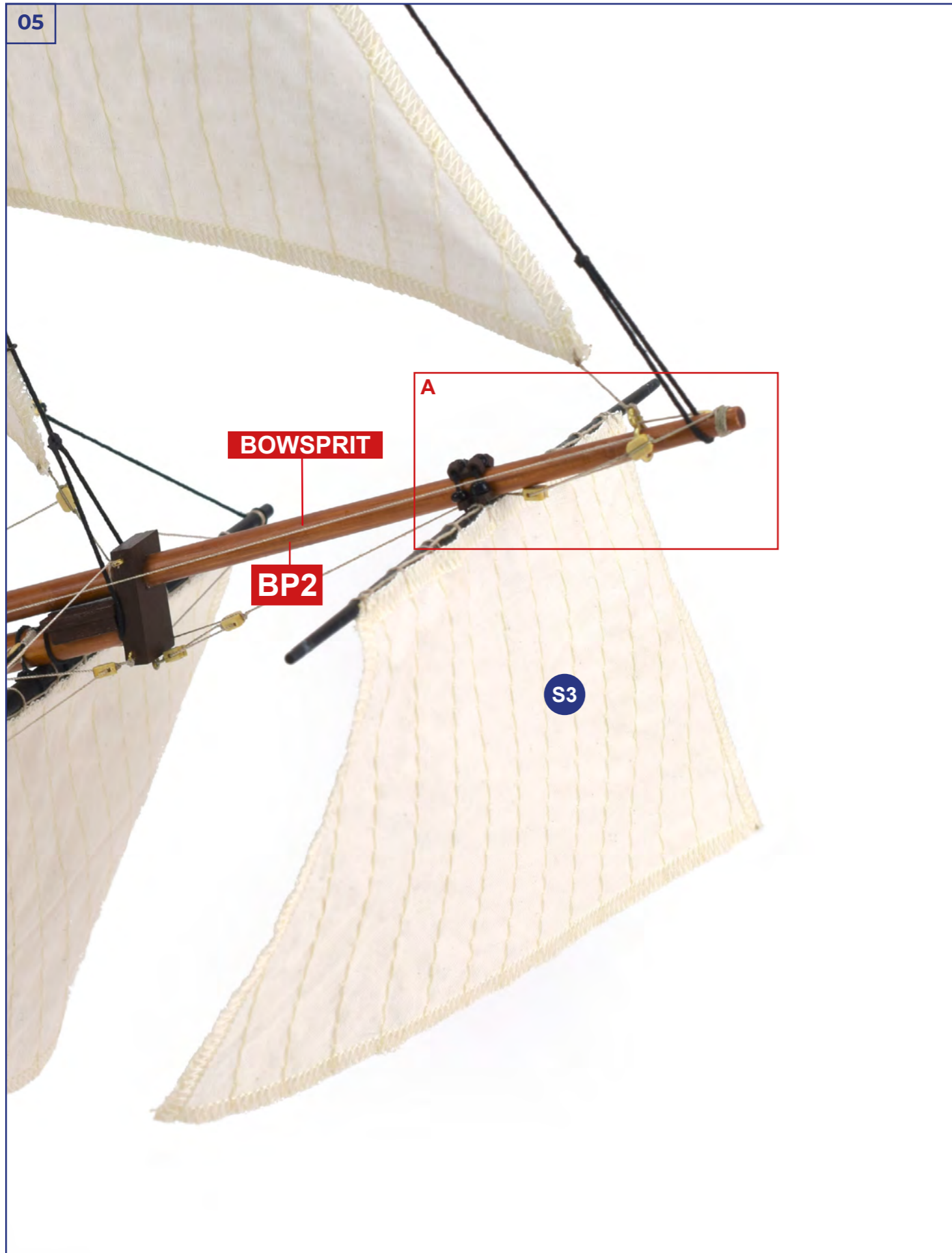

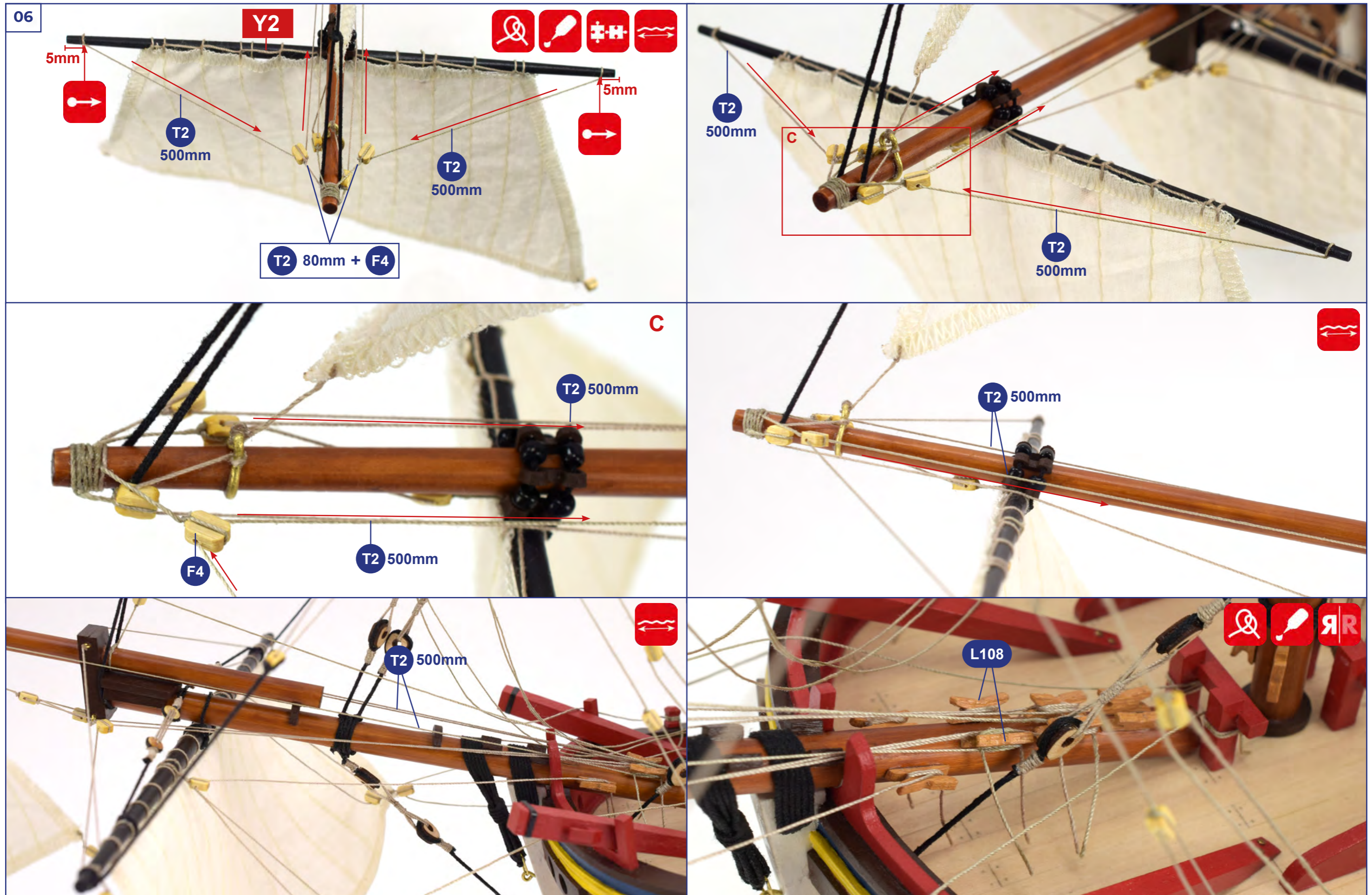

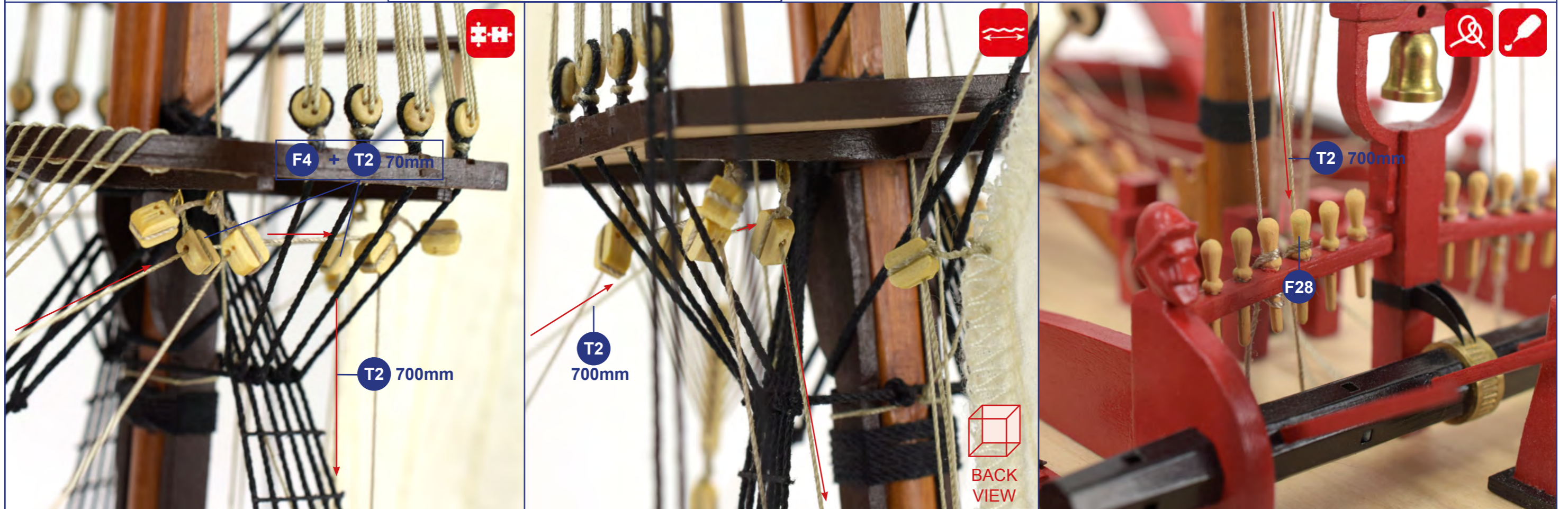
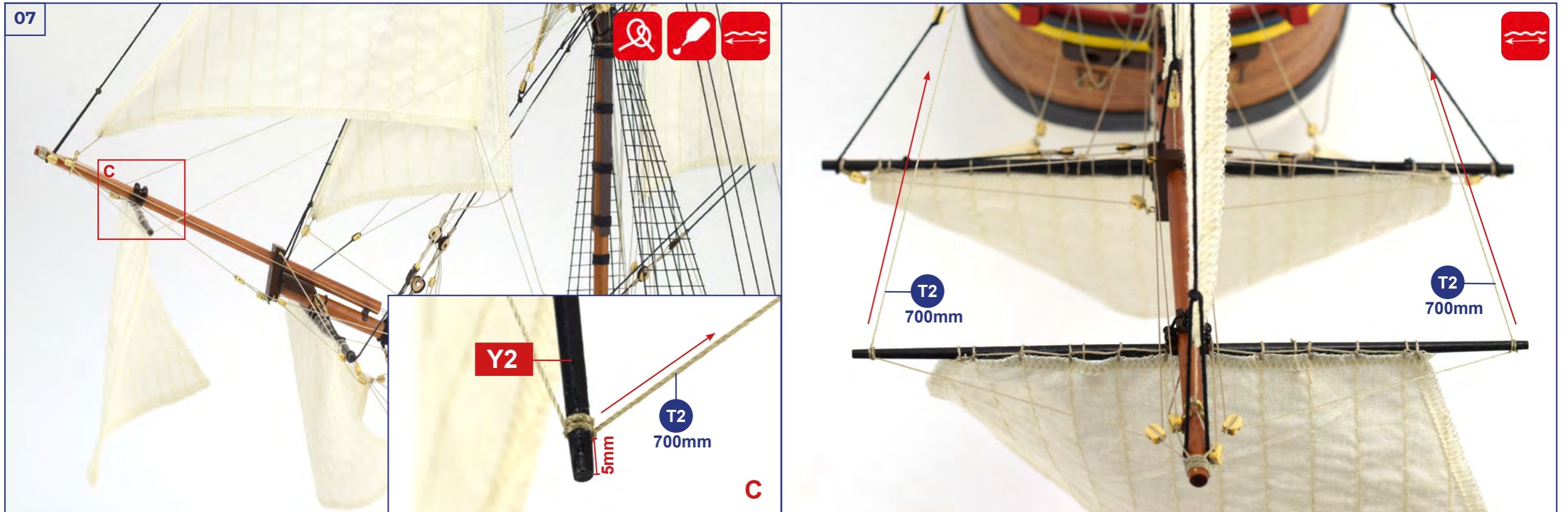

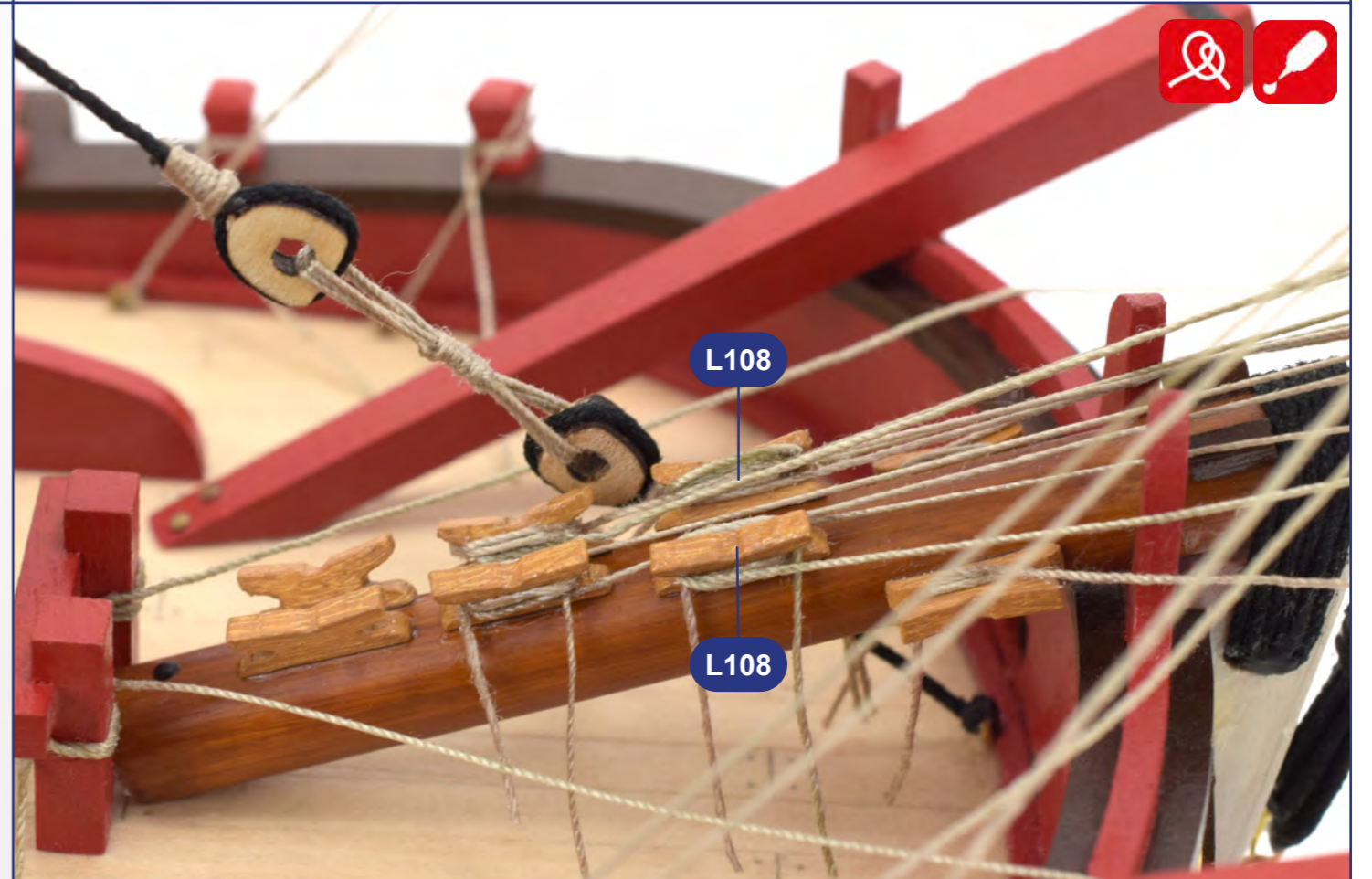
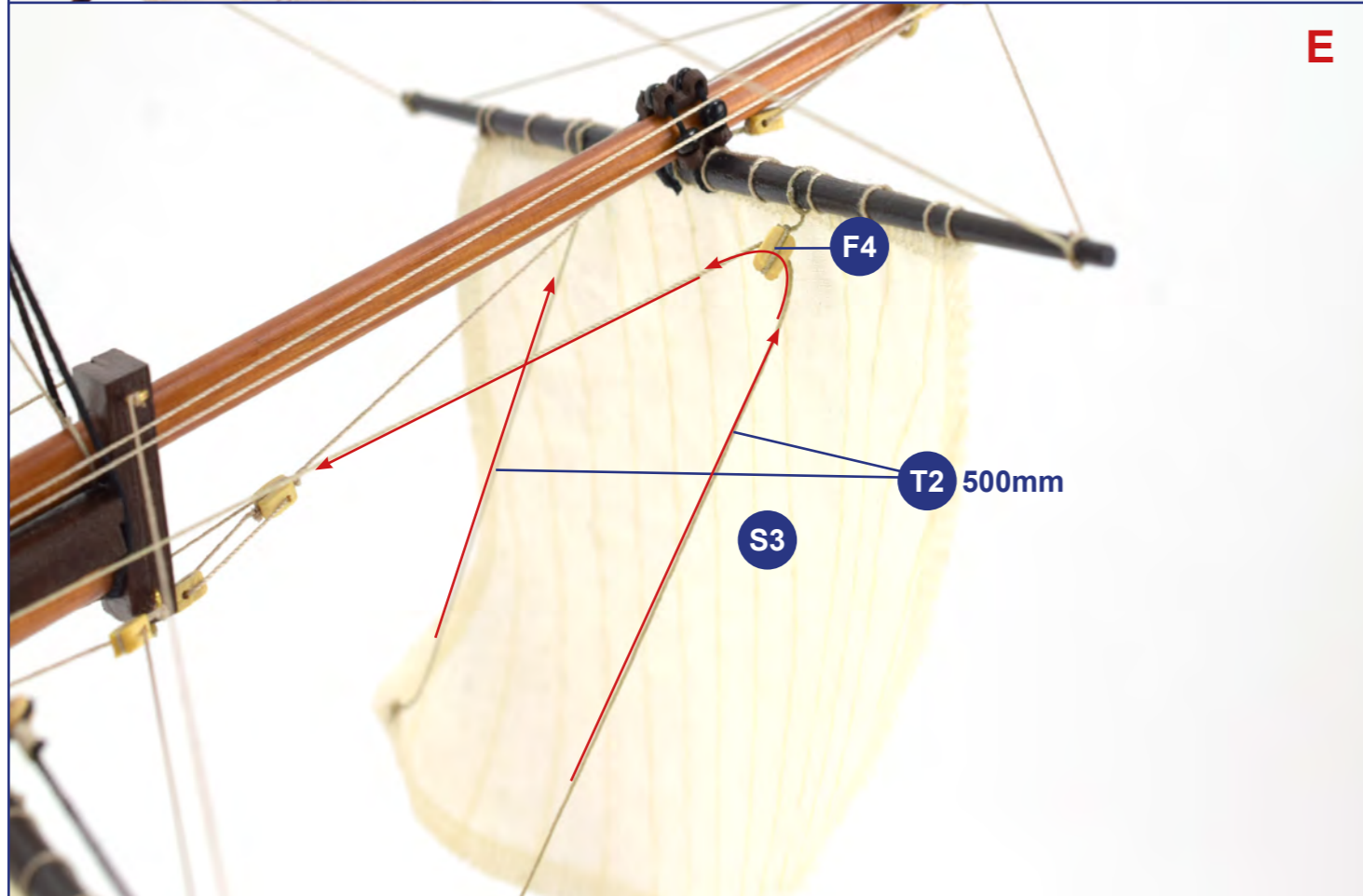
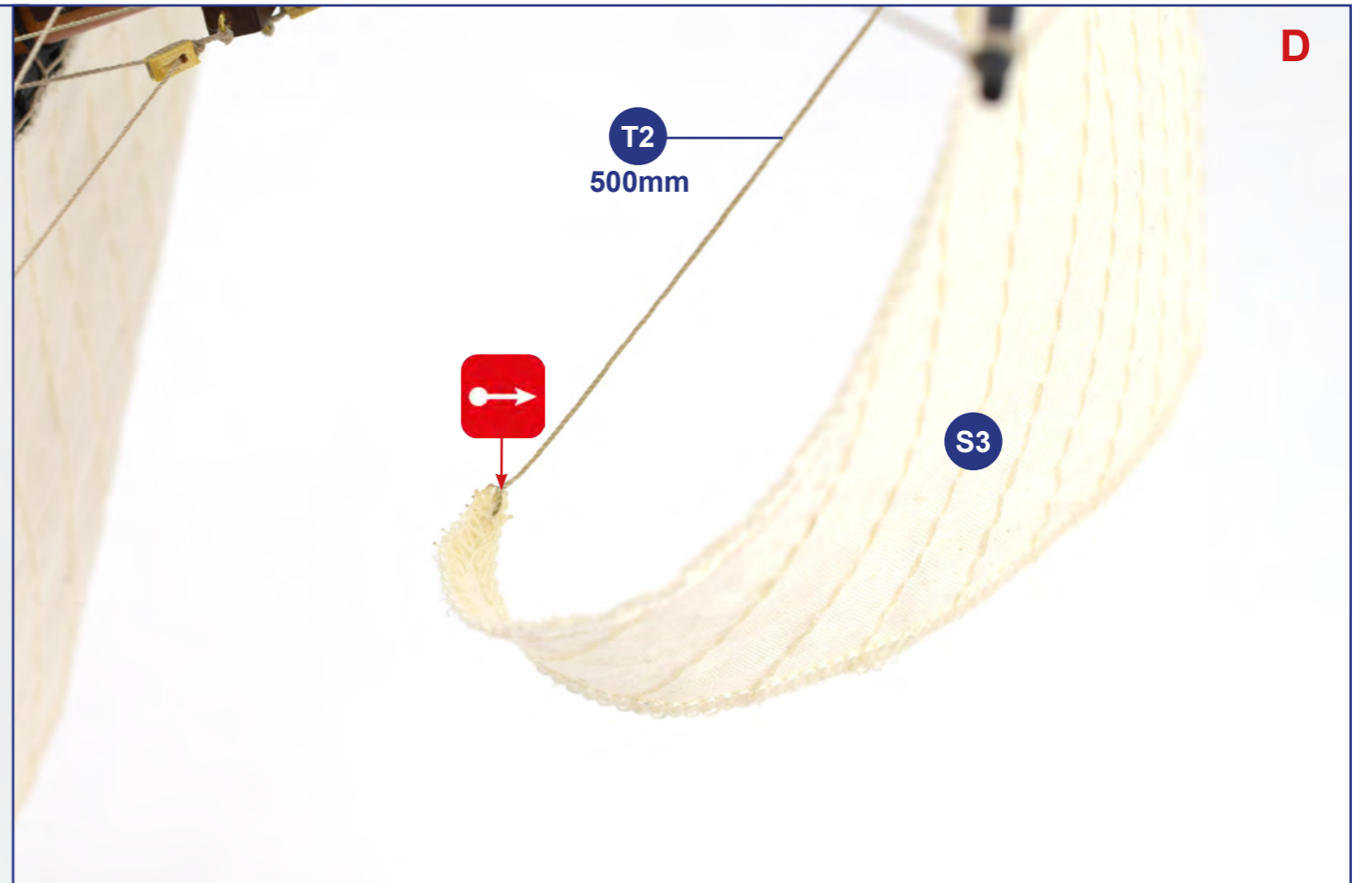
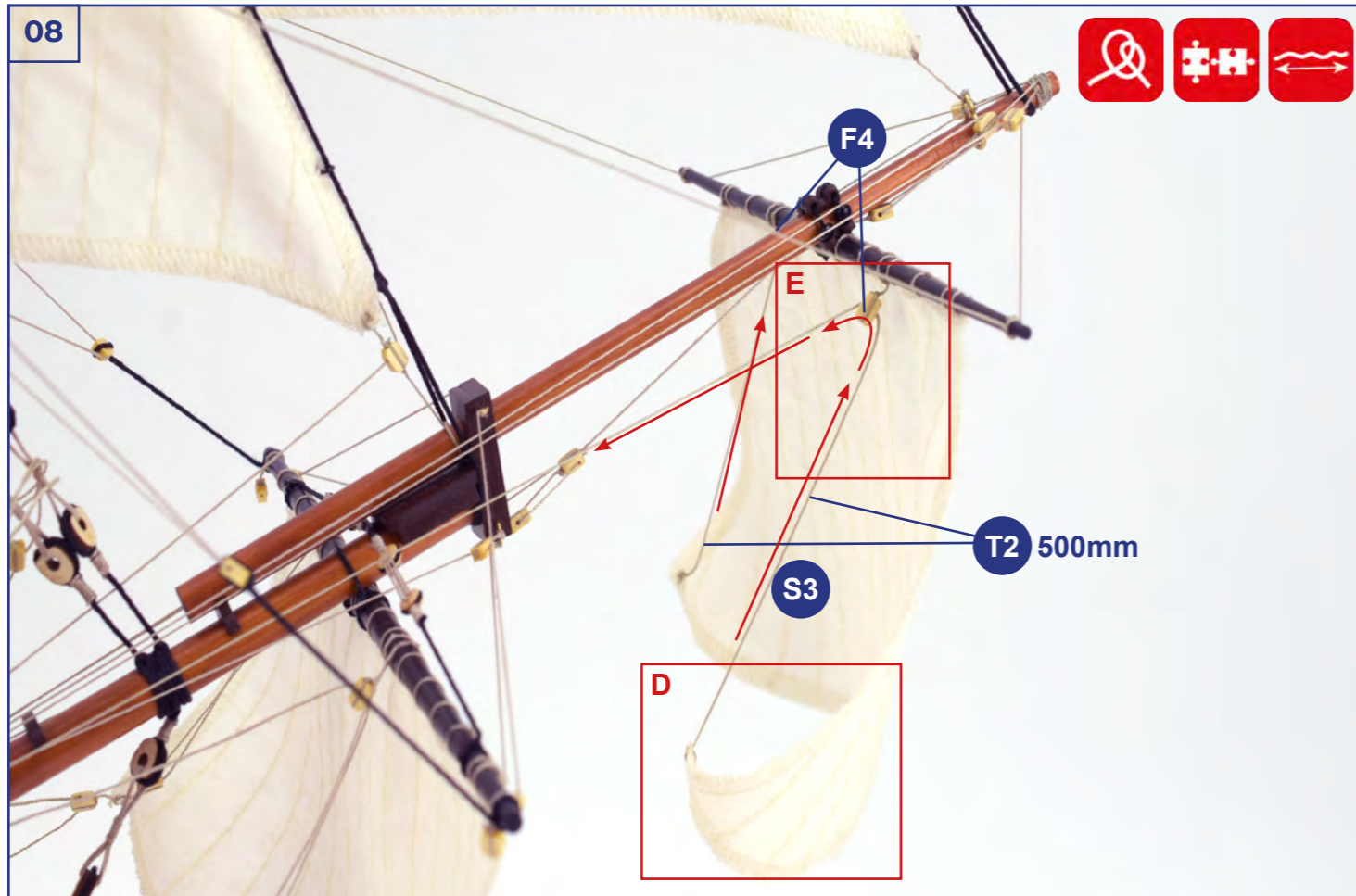

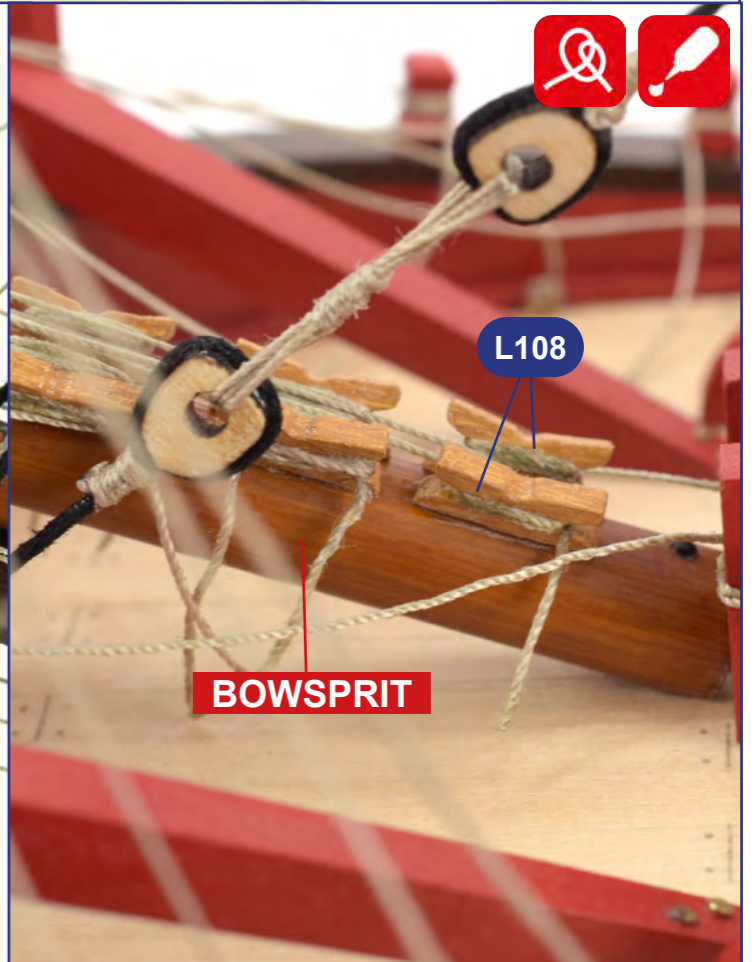
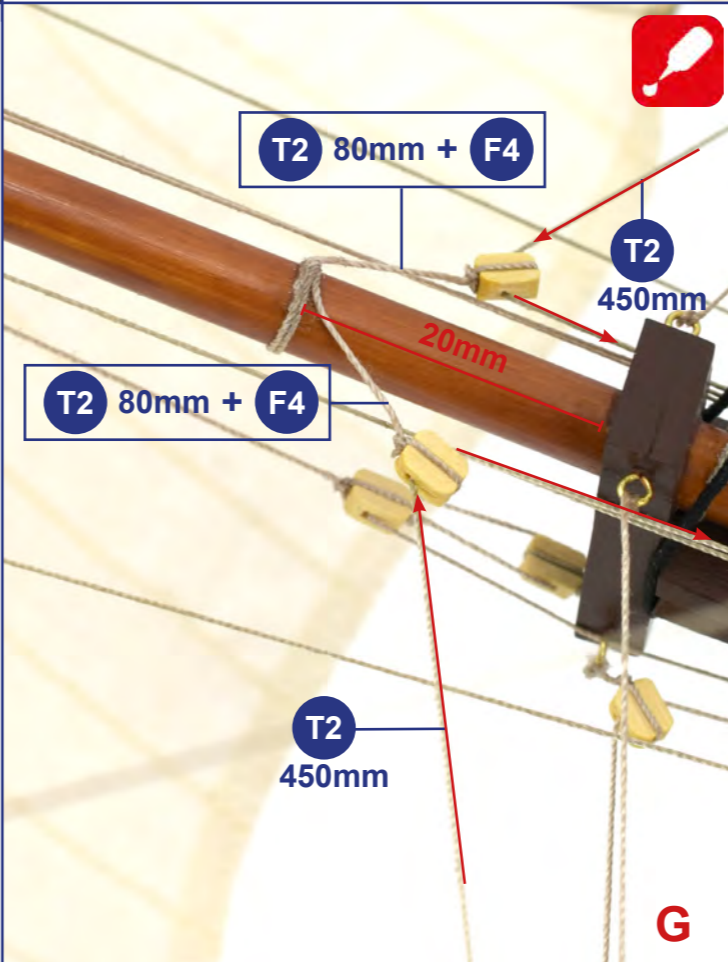
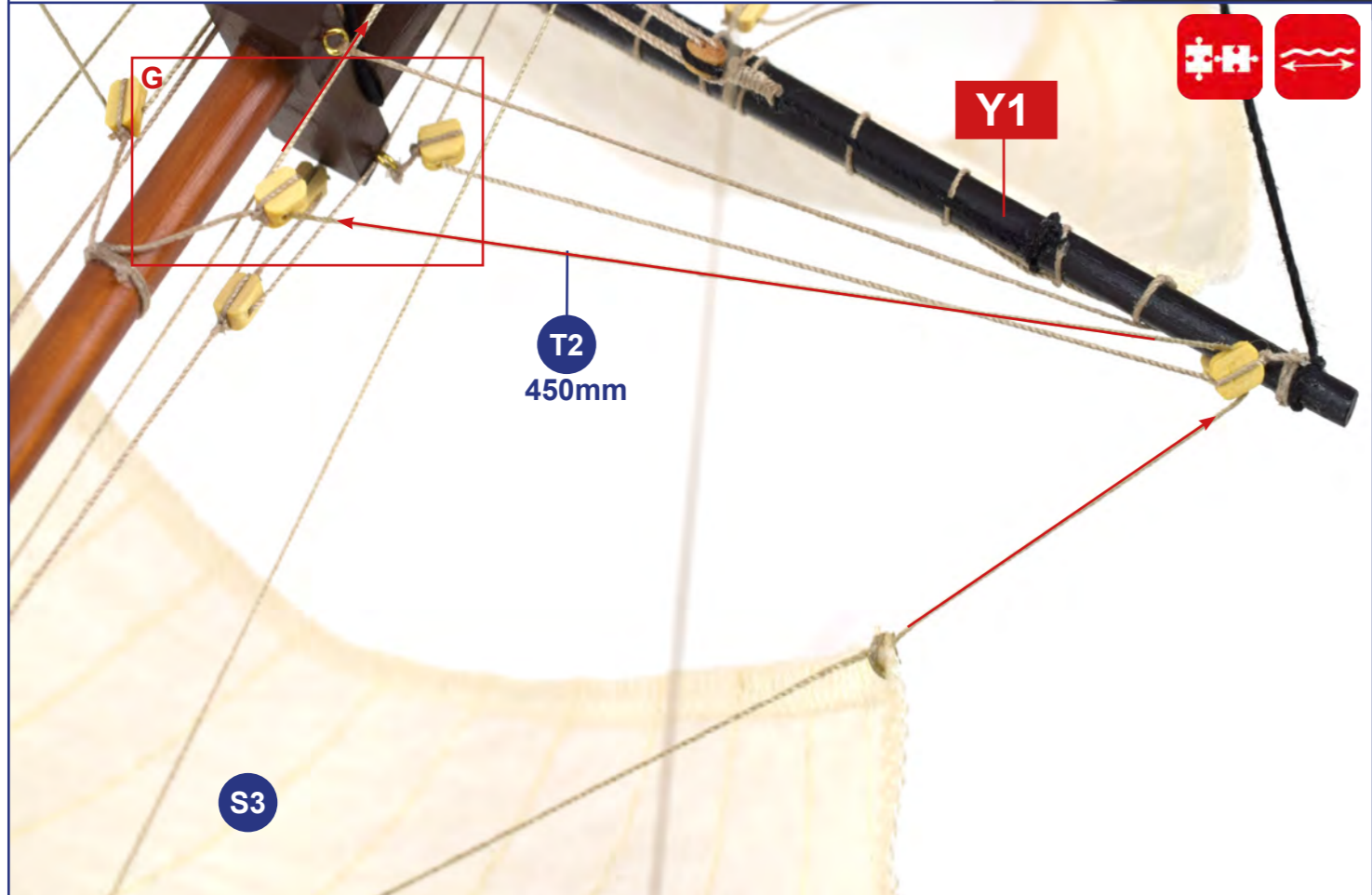
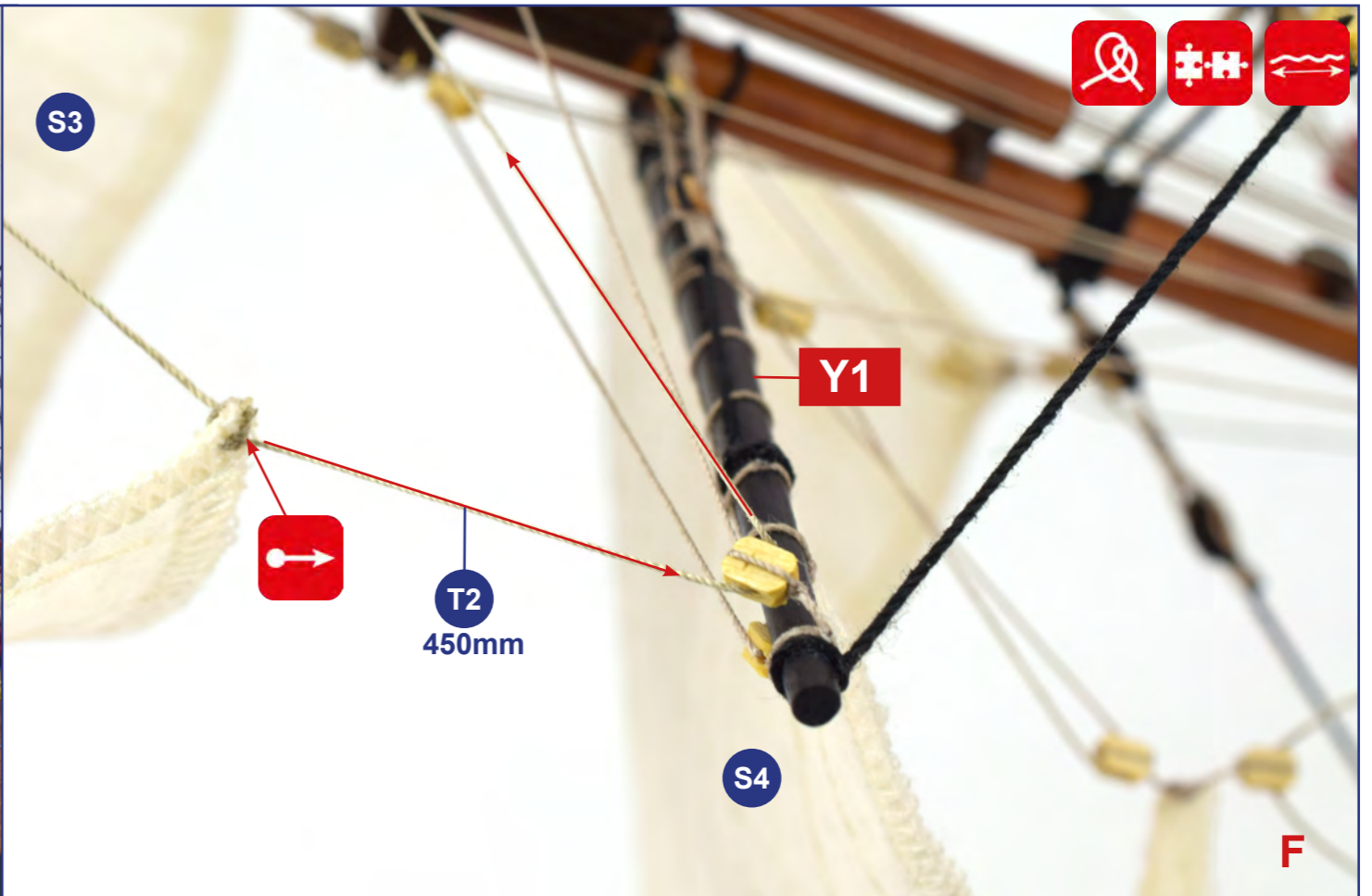
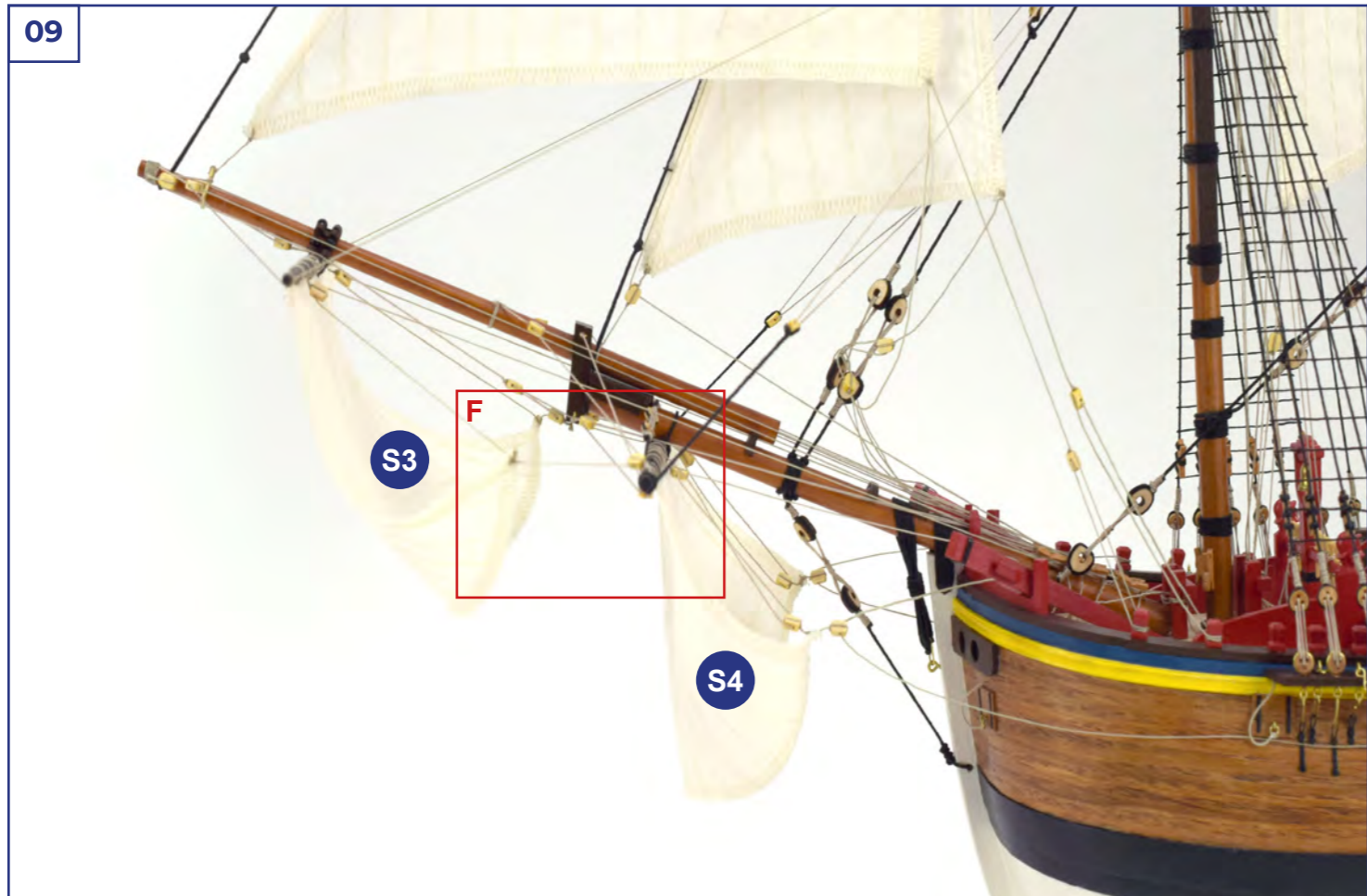

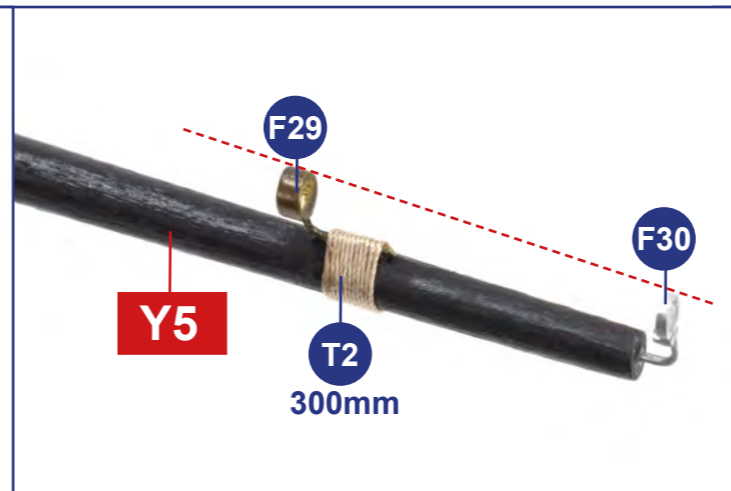
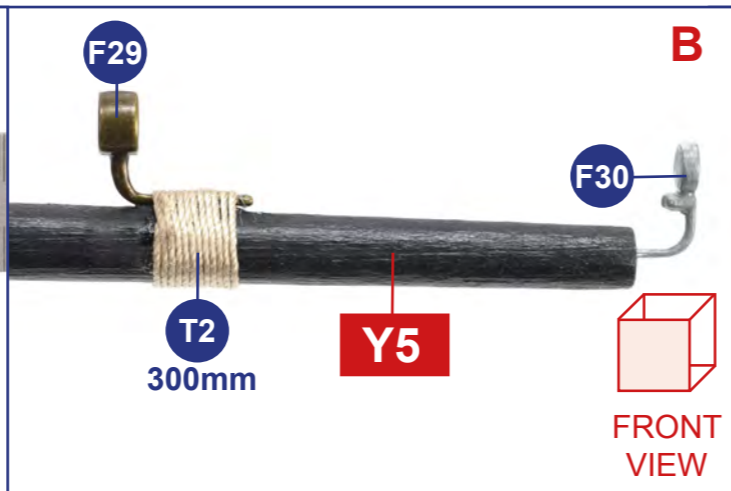
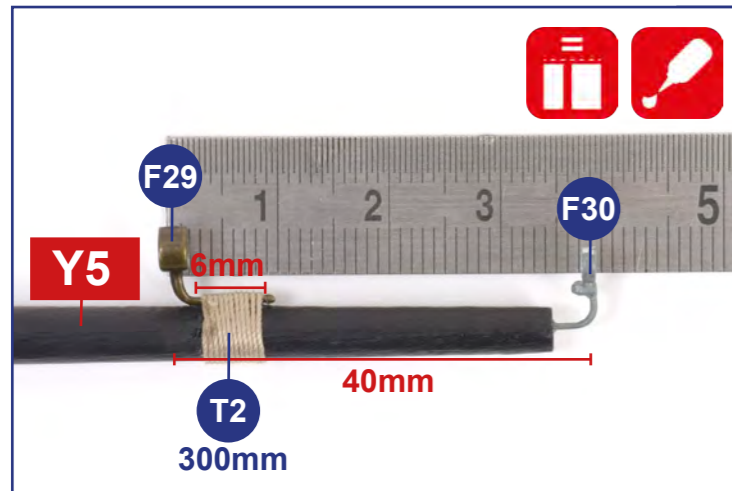
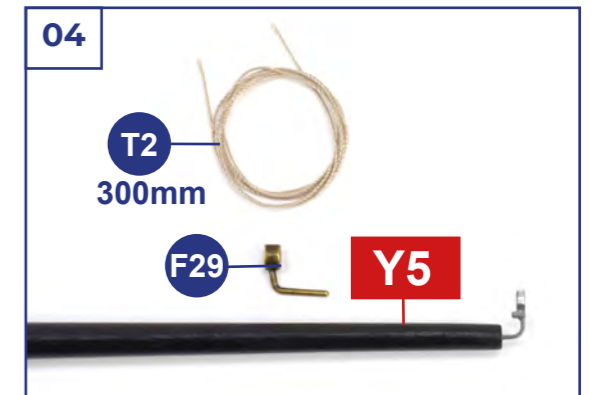
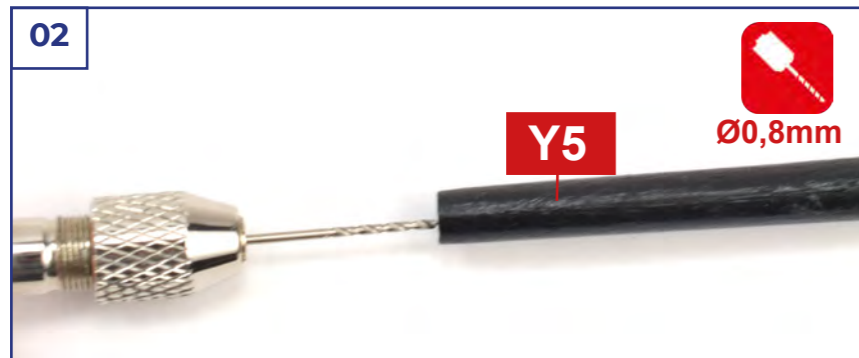
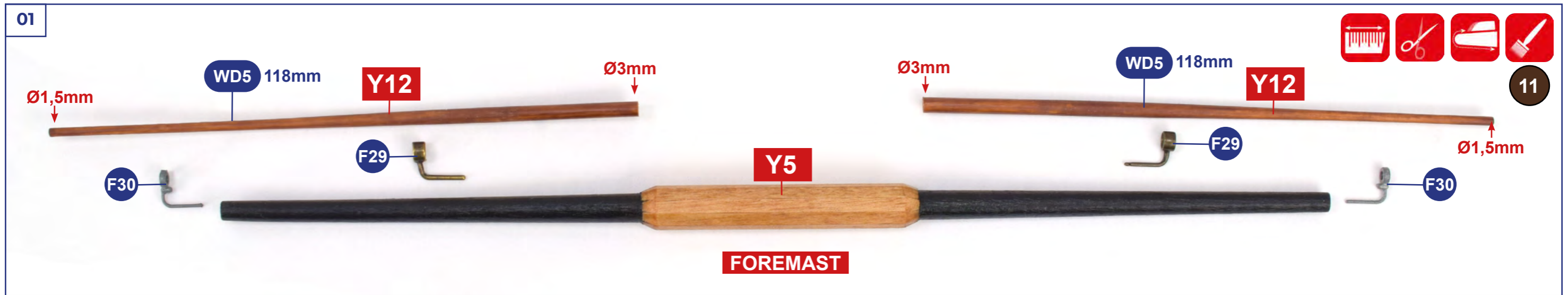

05

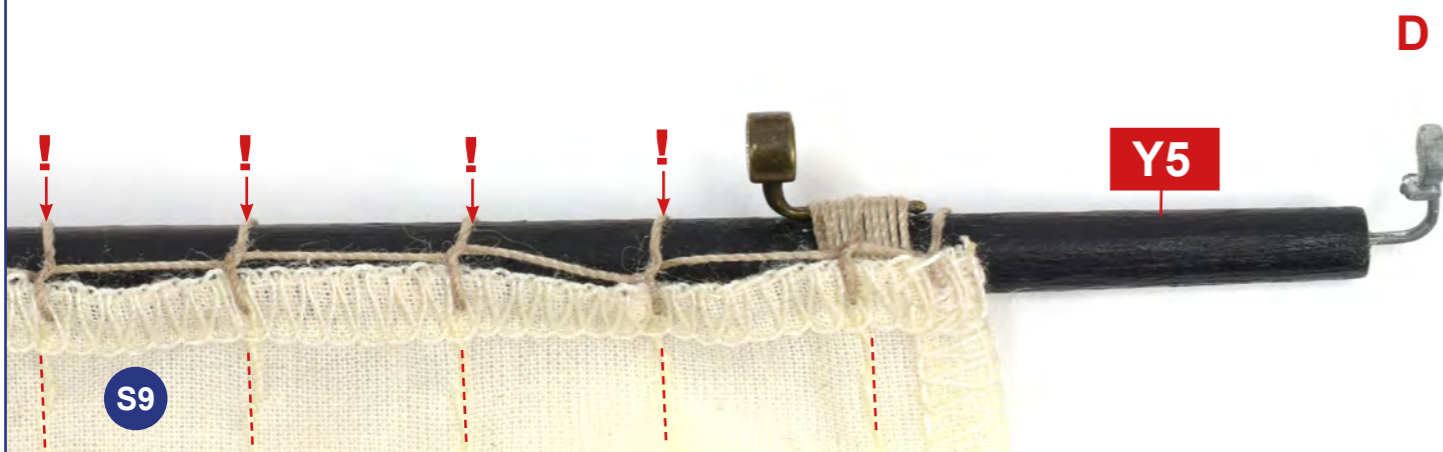
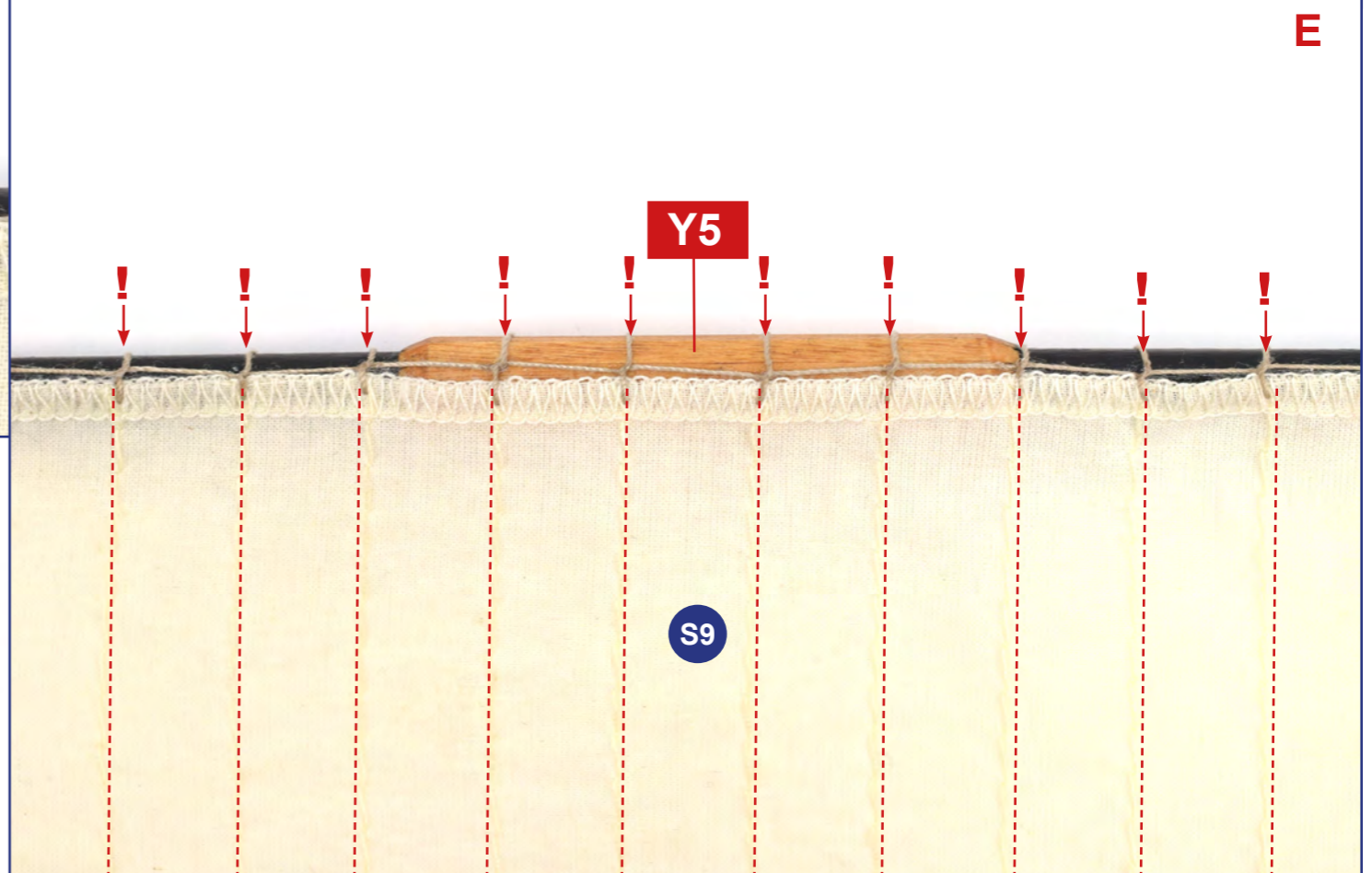
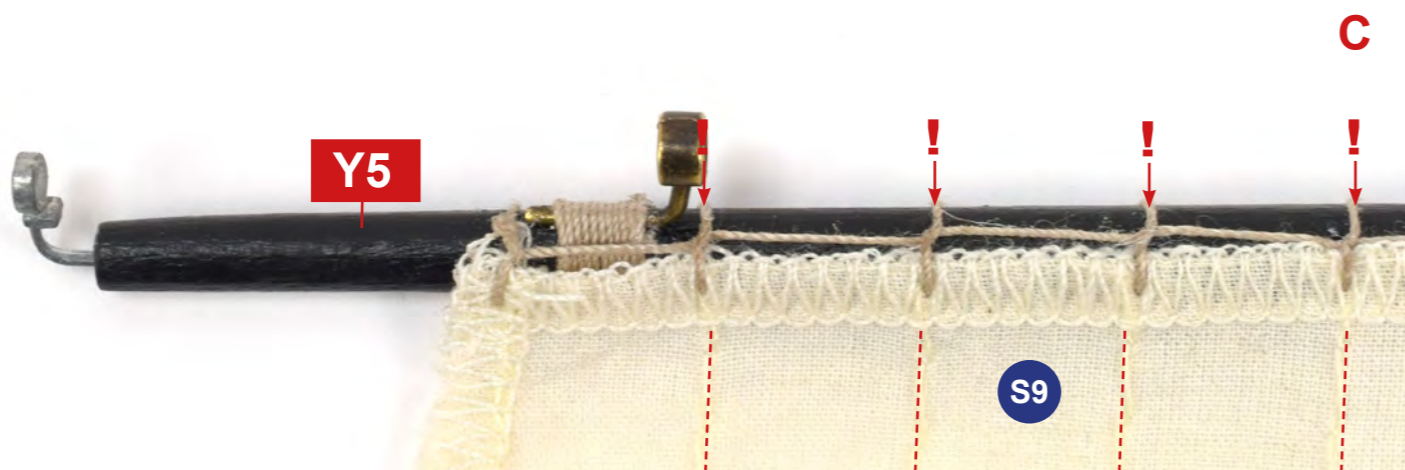
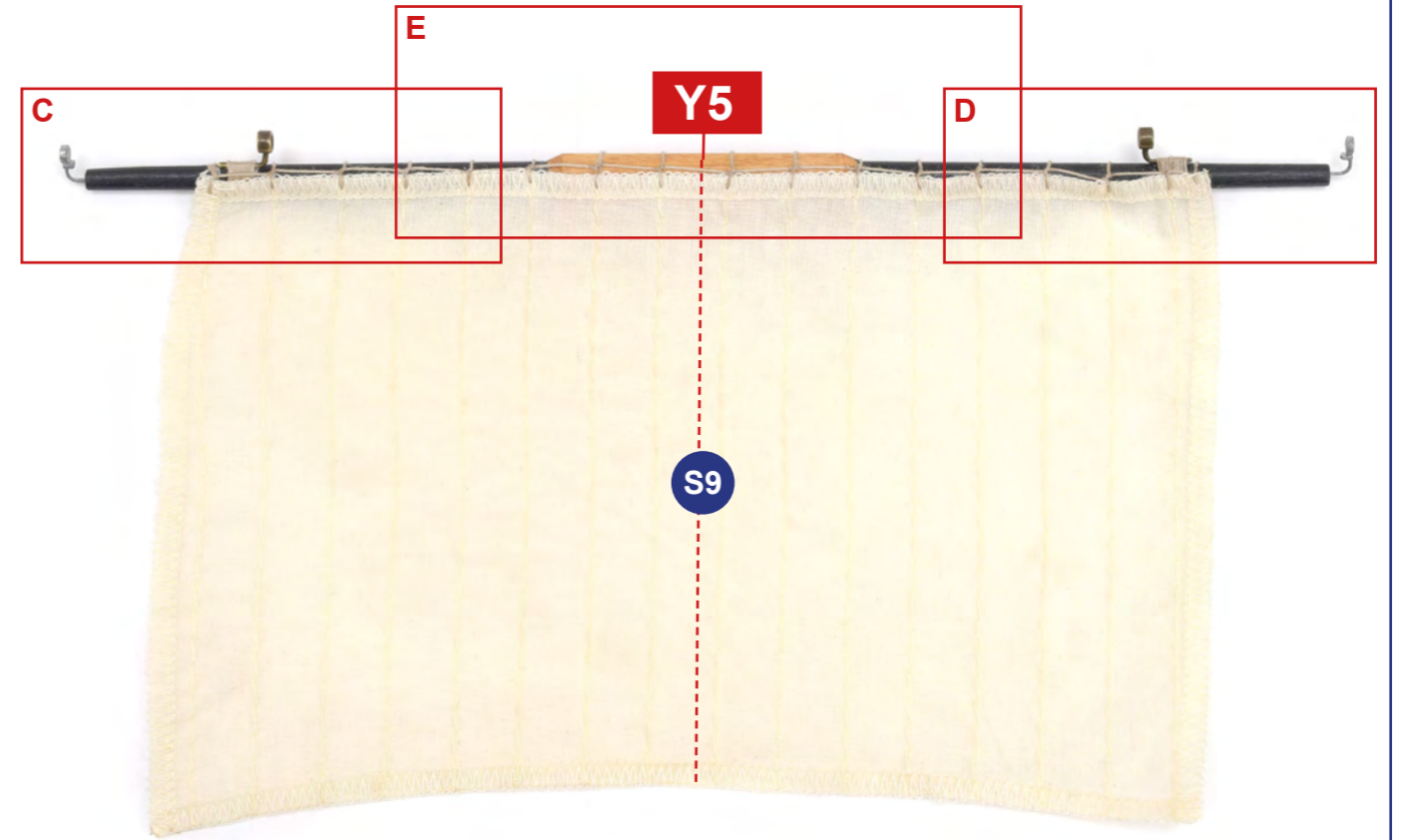
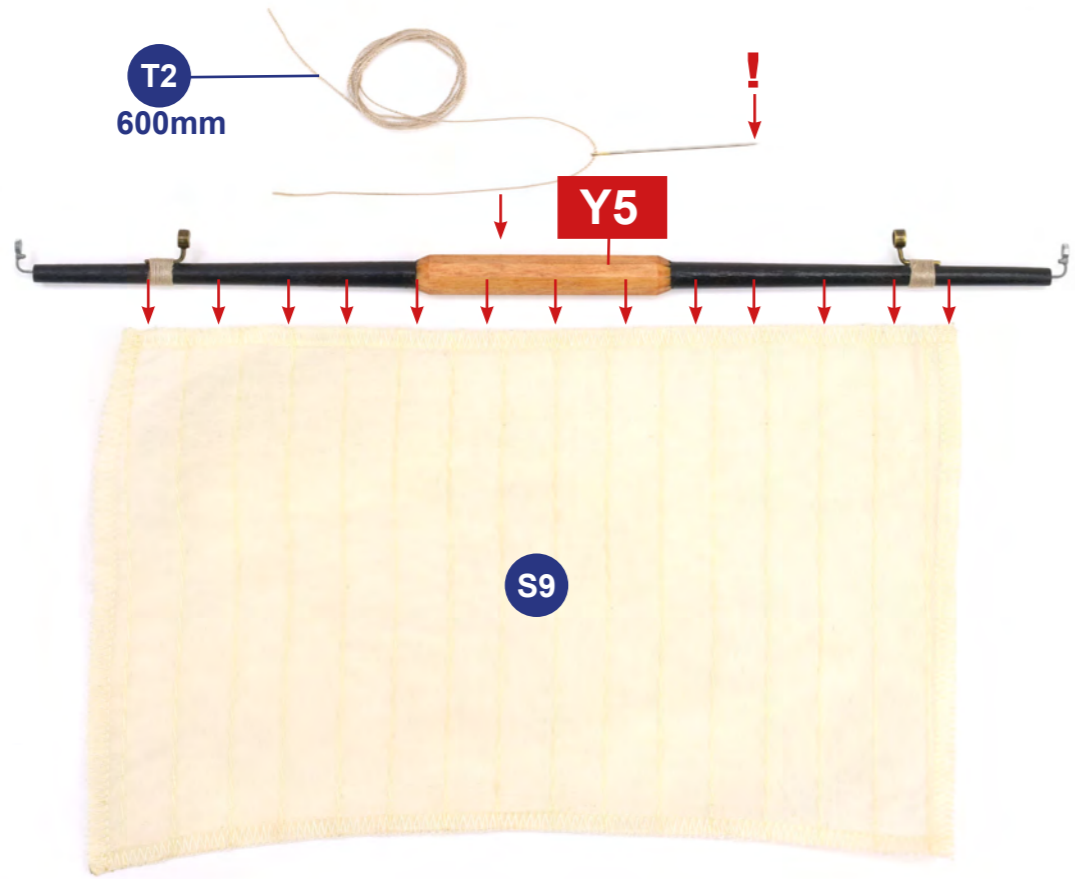

06

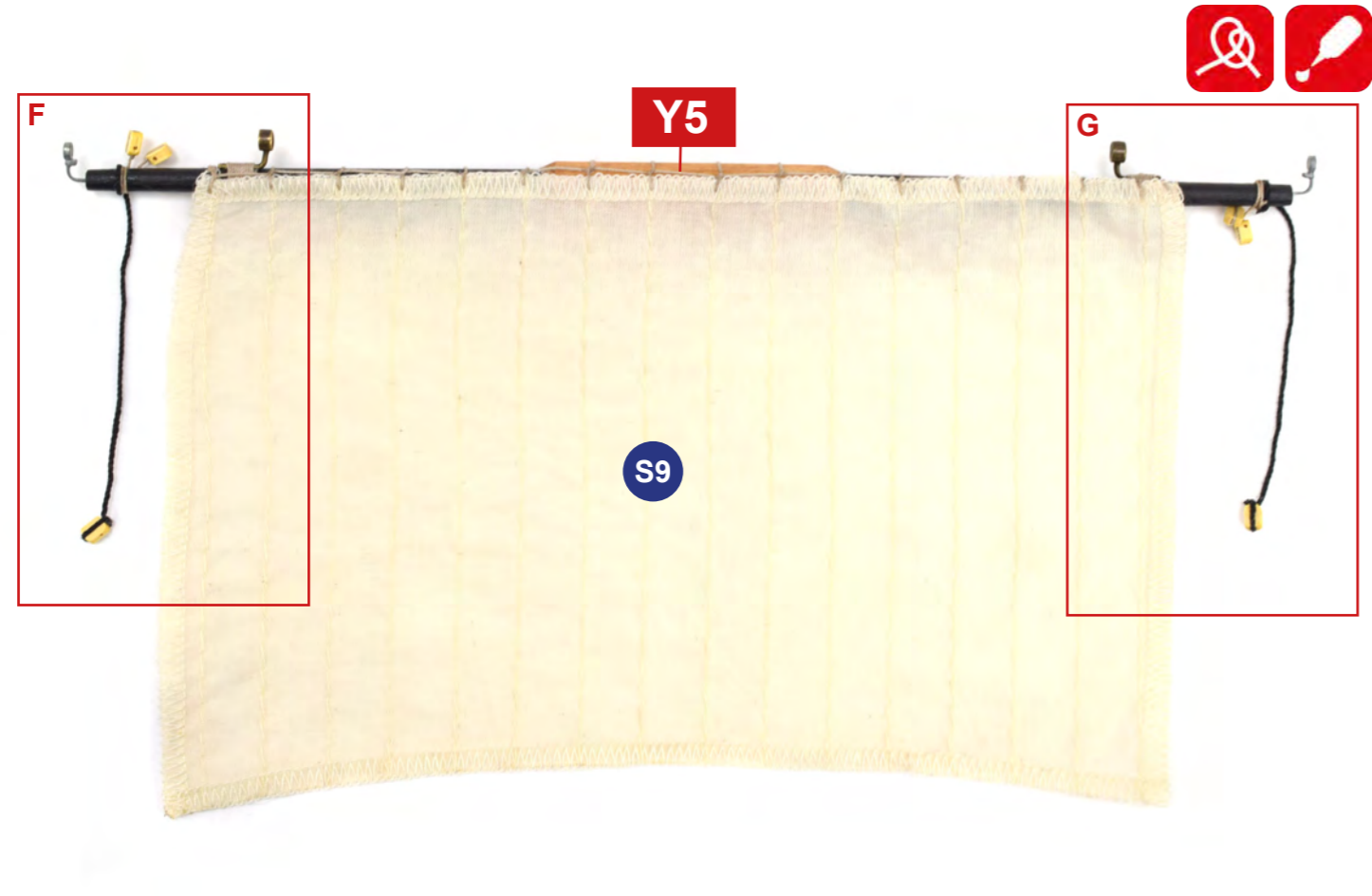
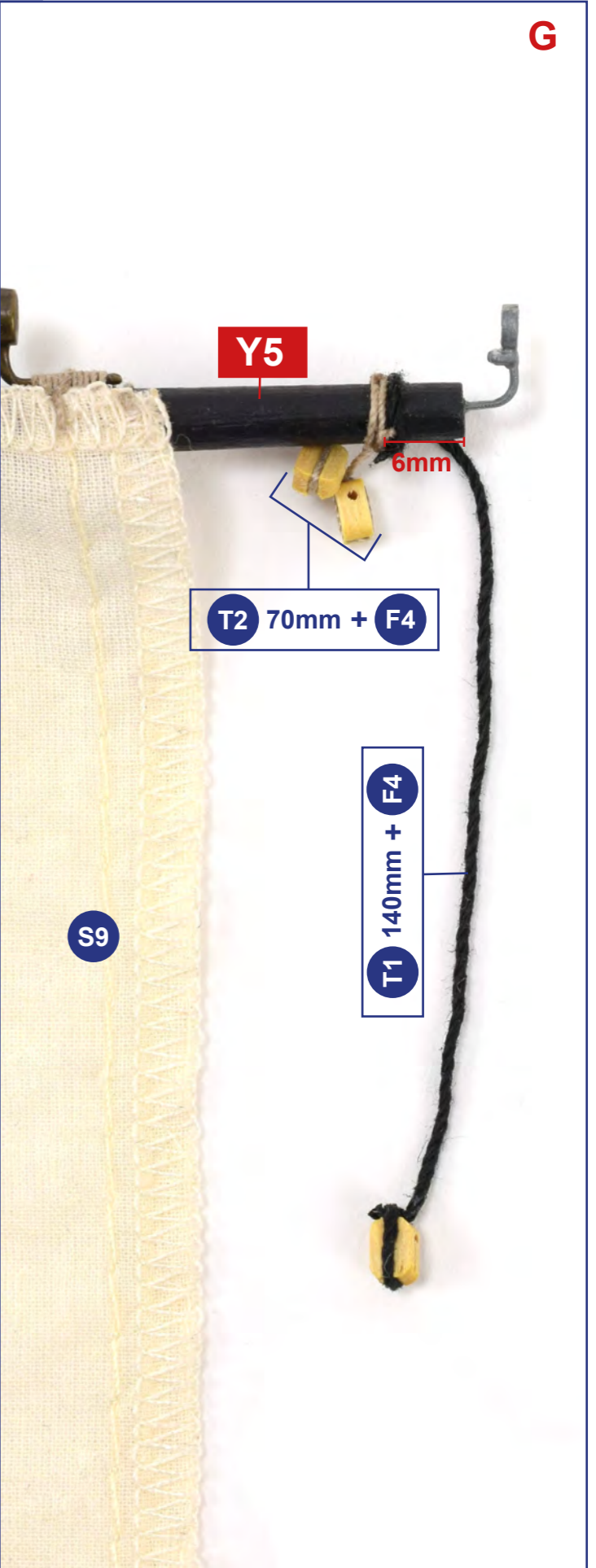
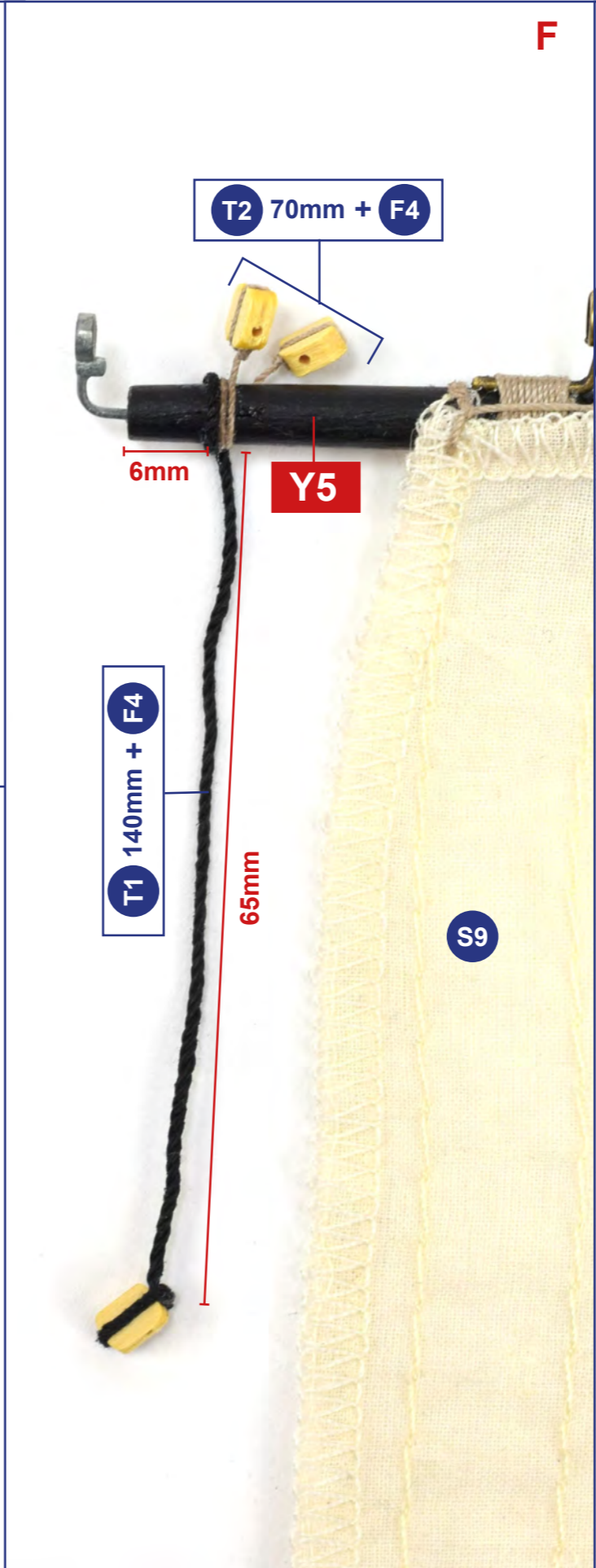
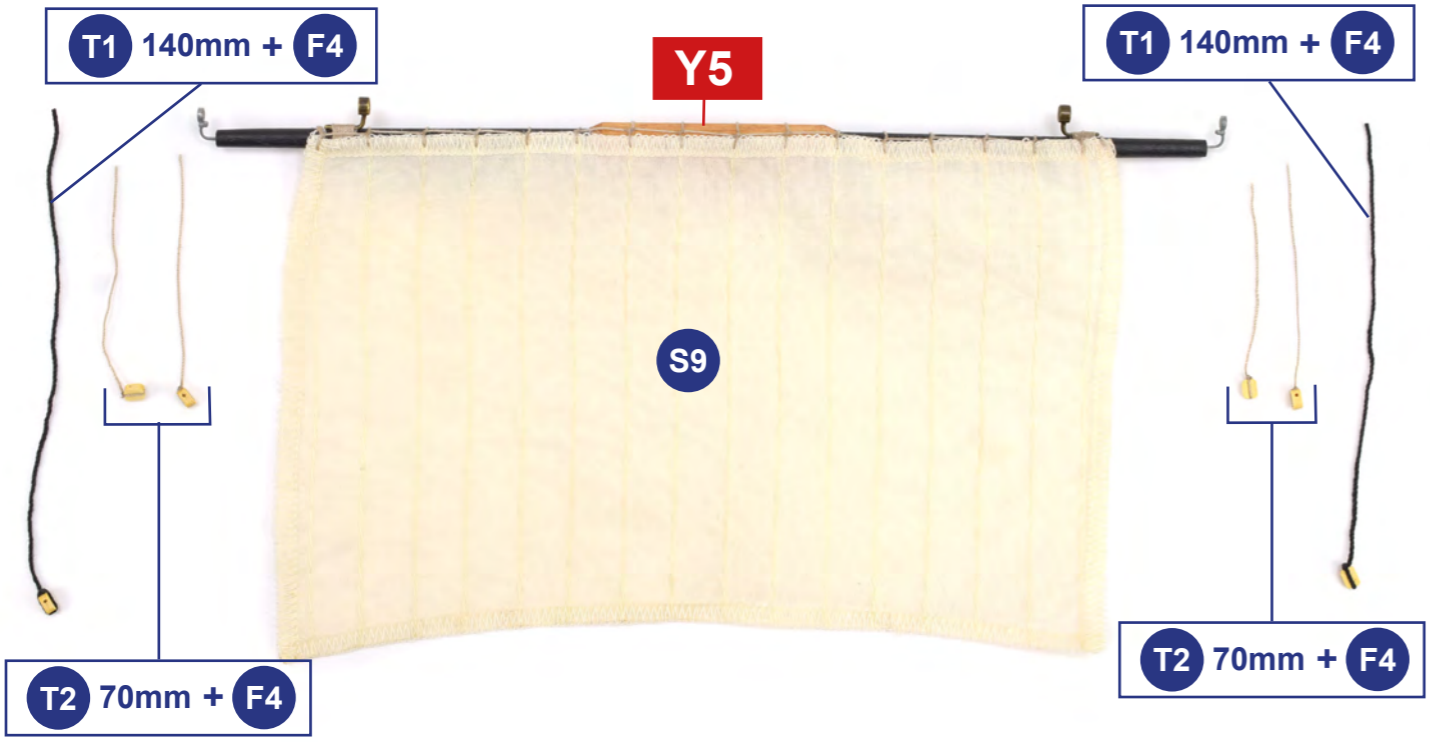

07

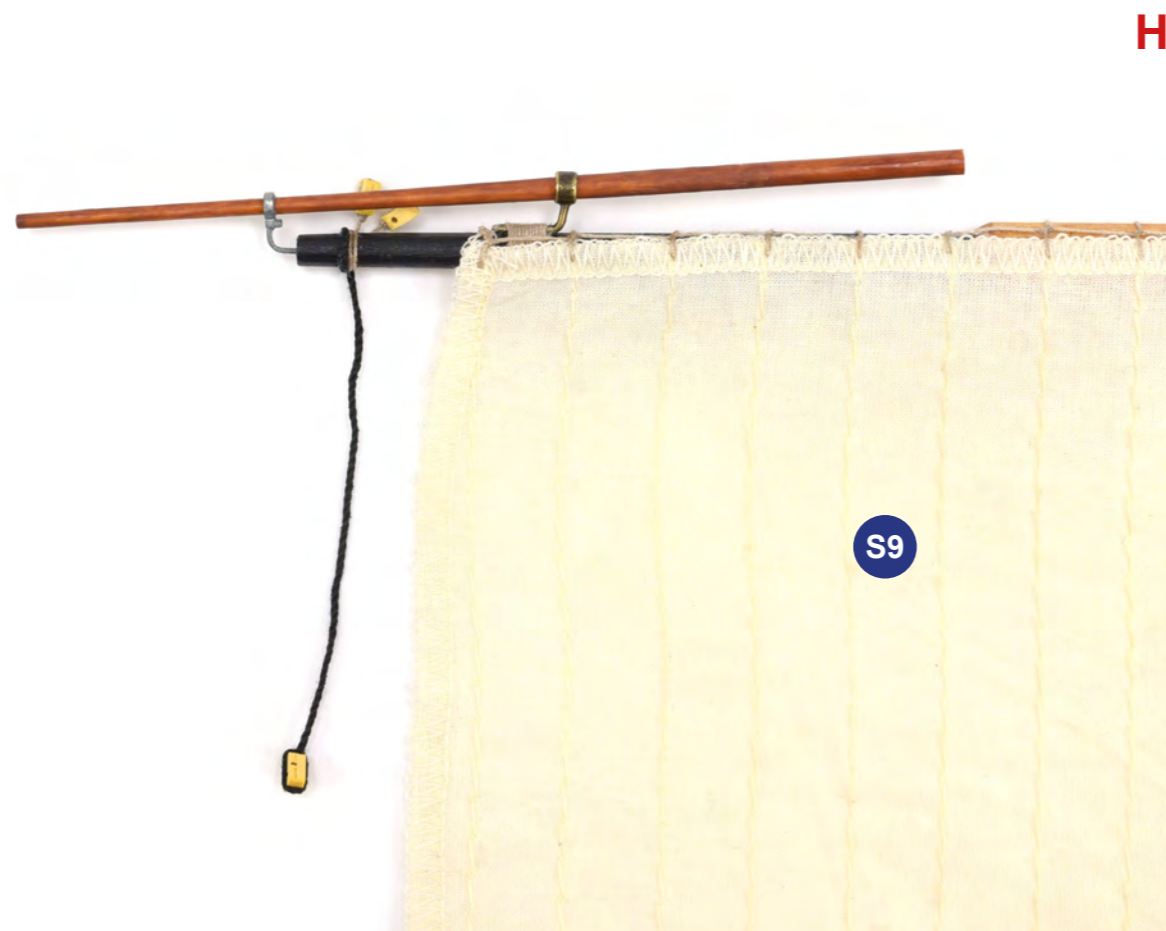
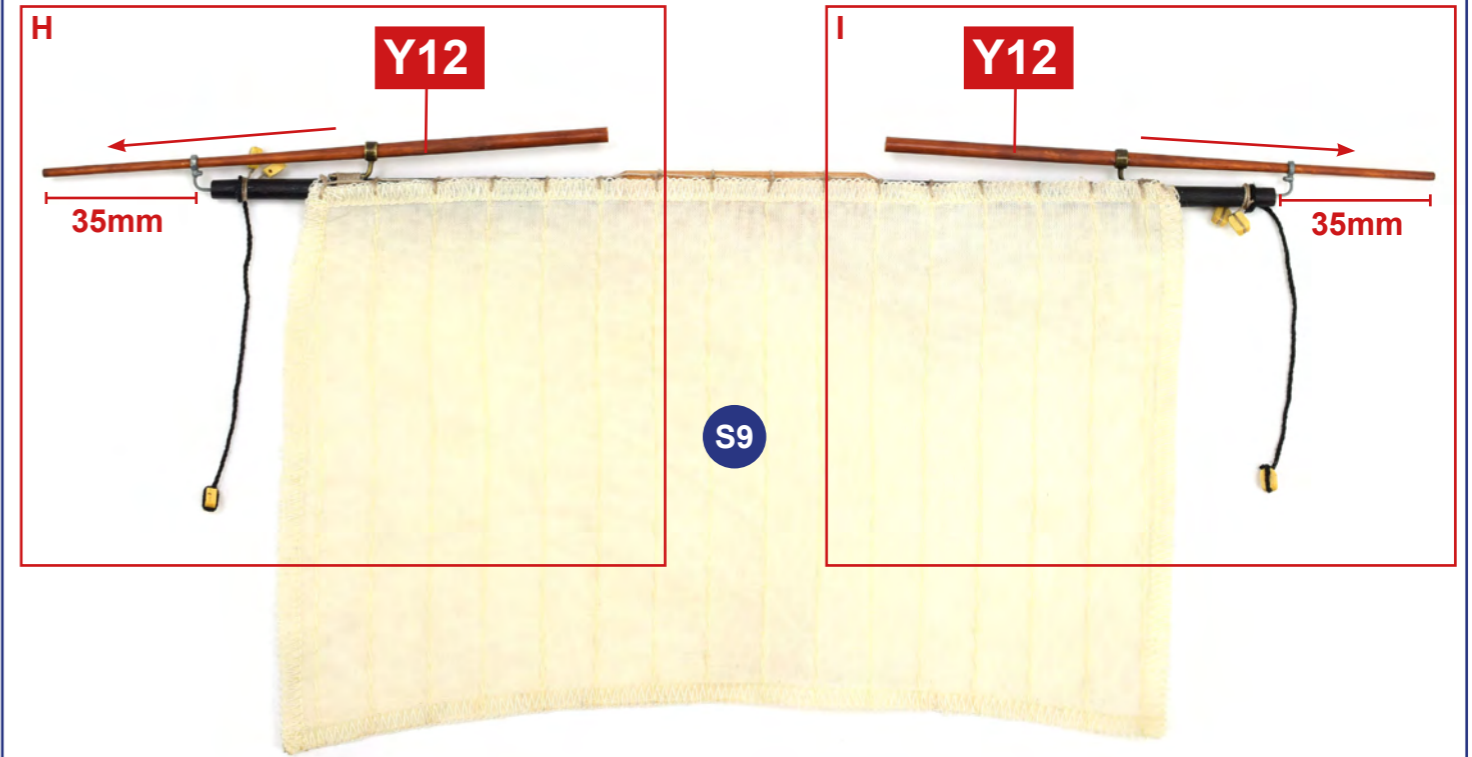
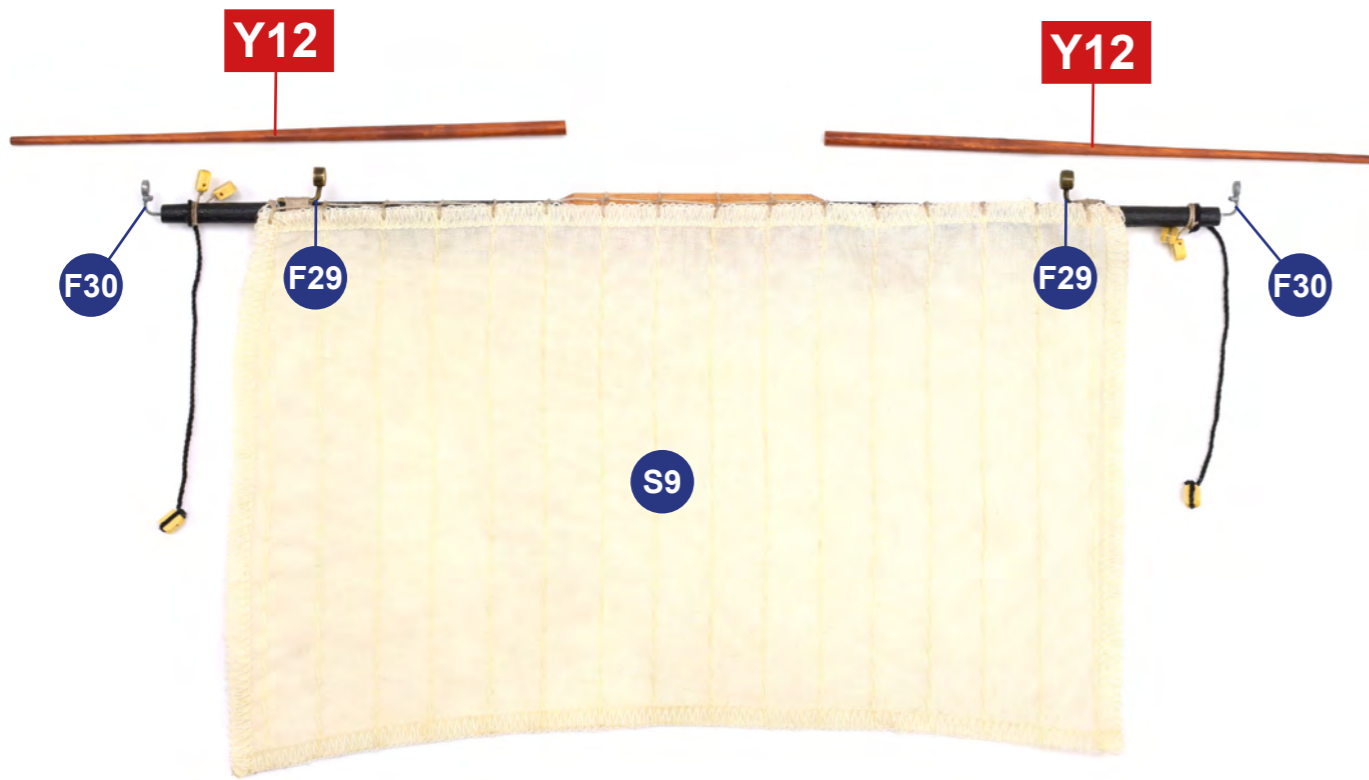

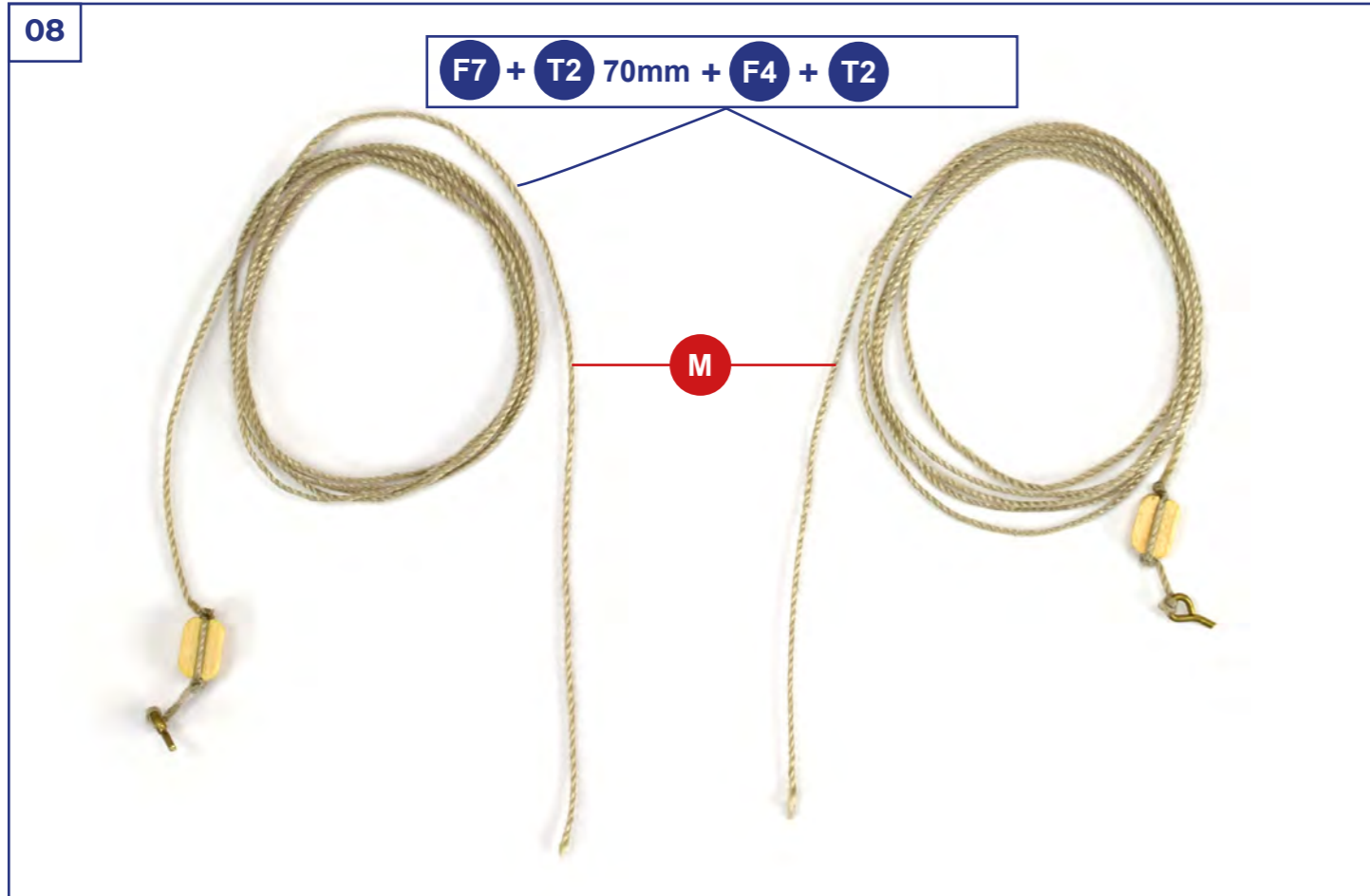



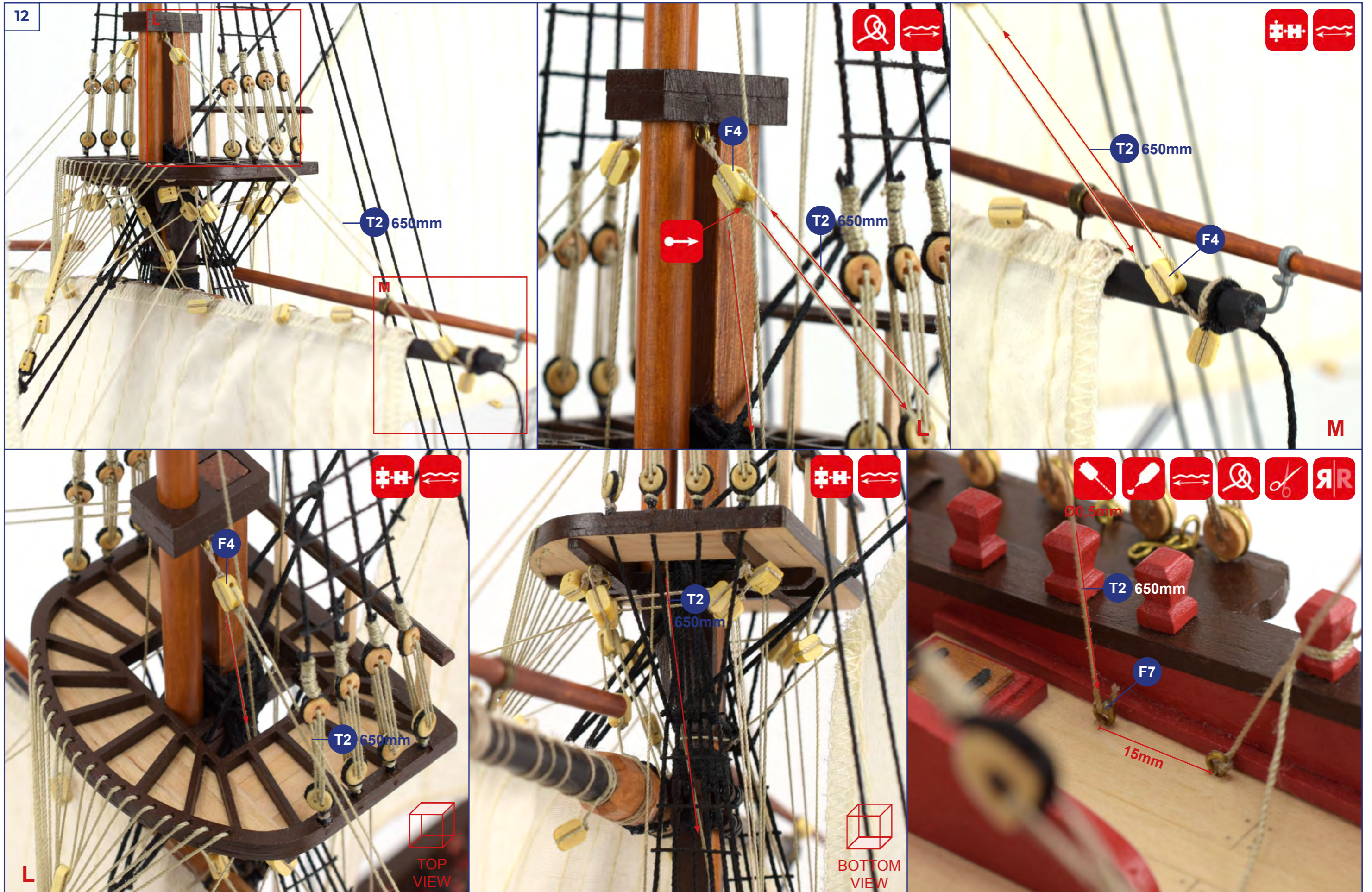

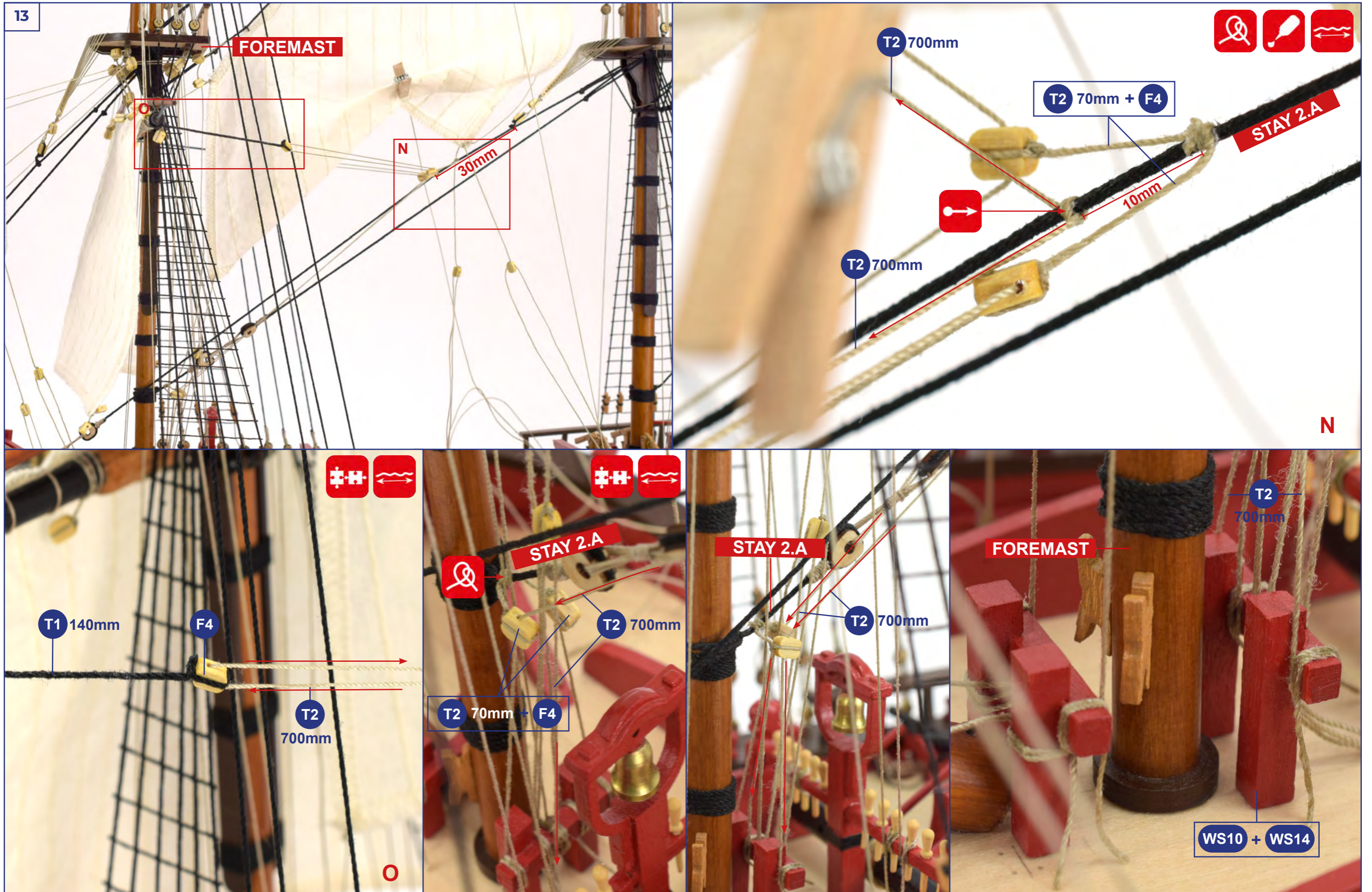

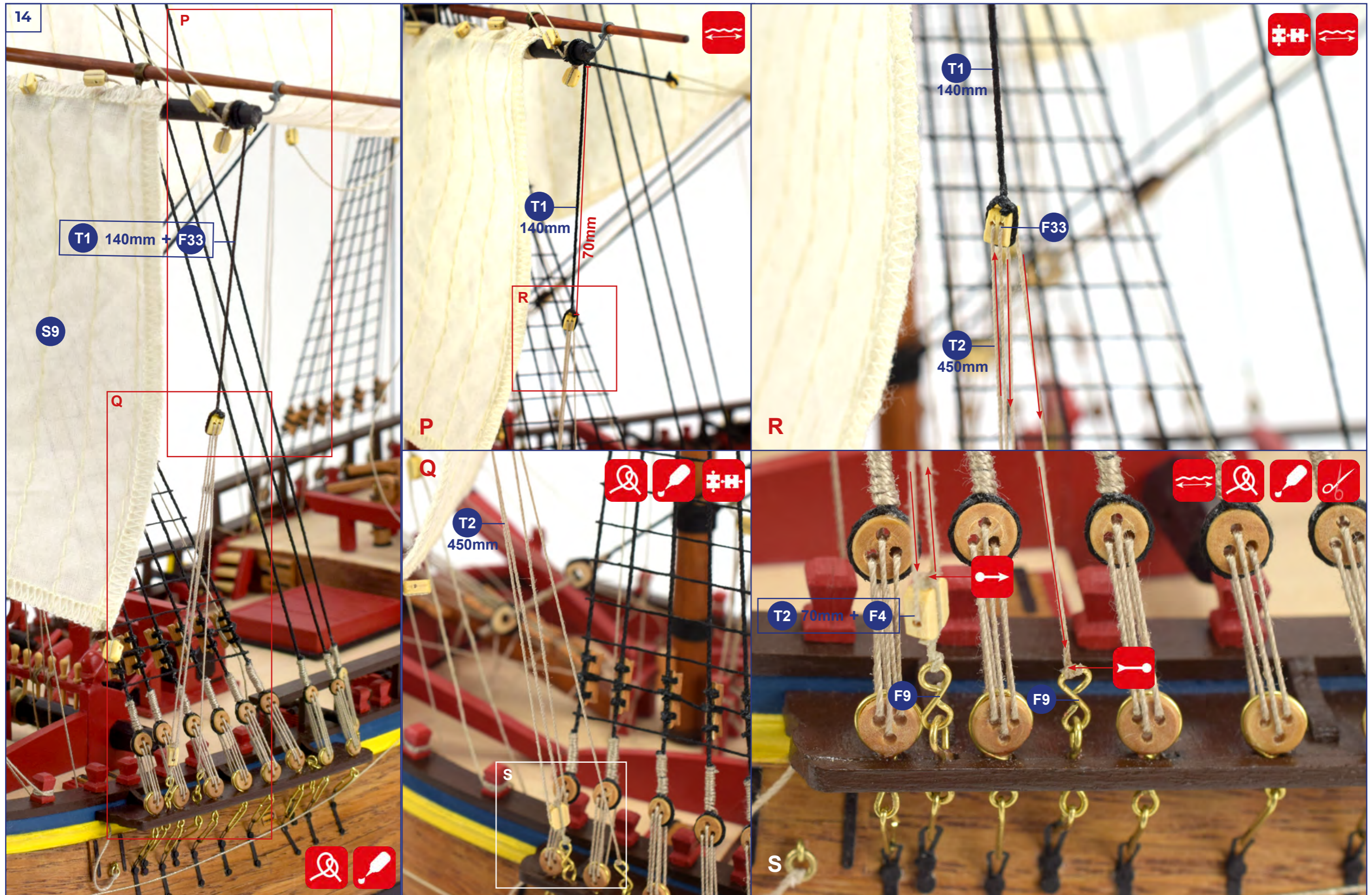

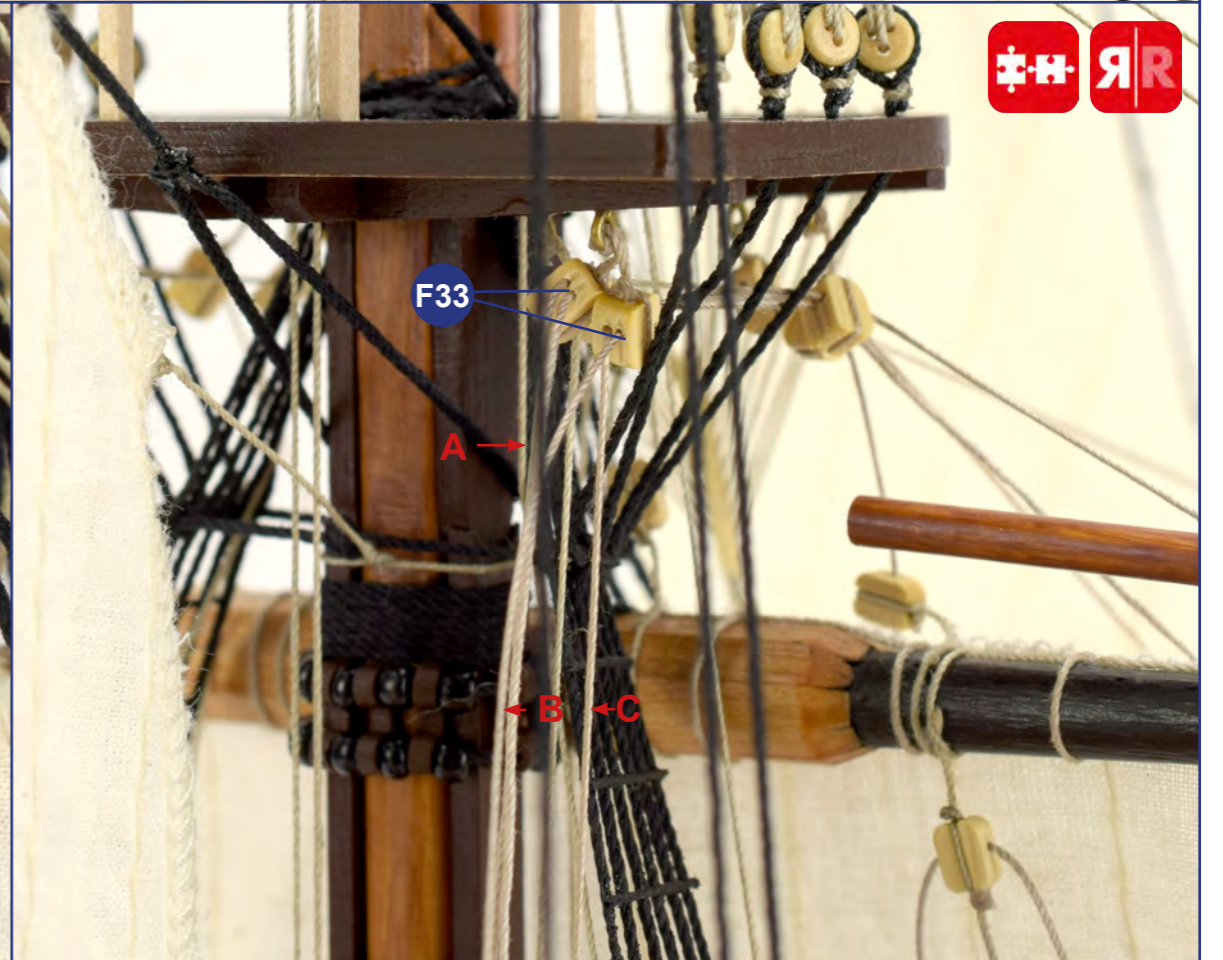
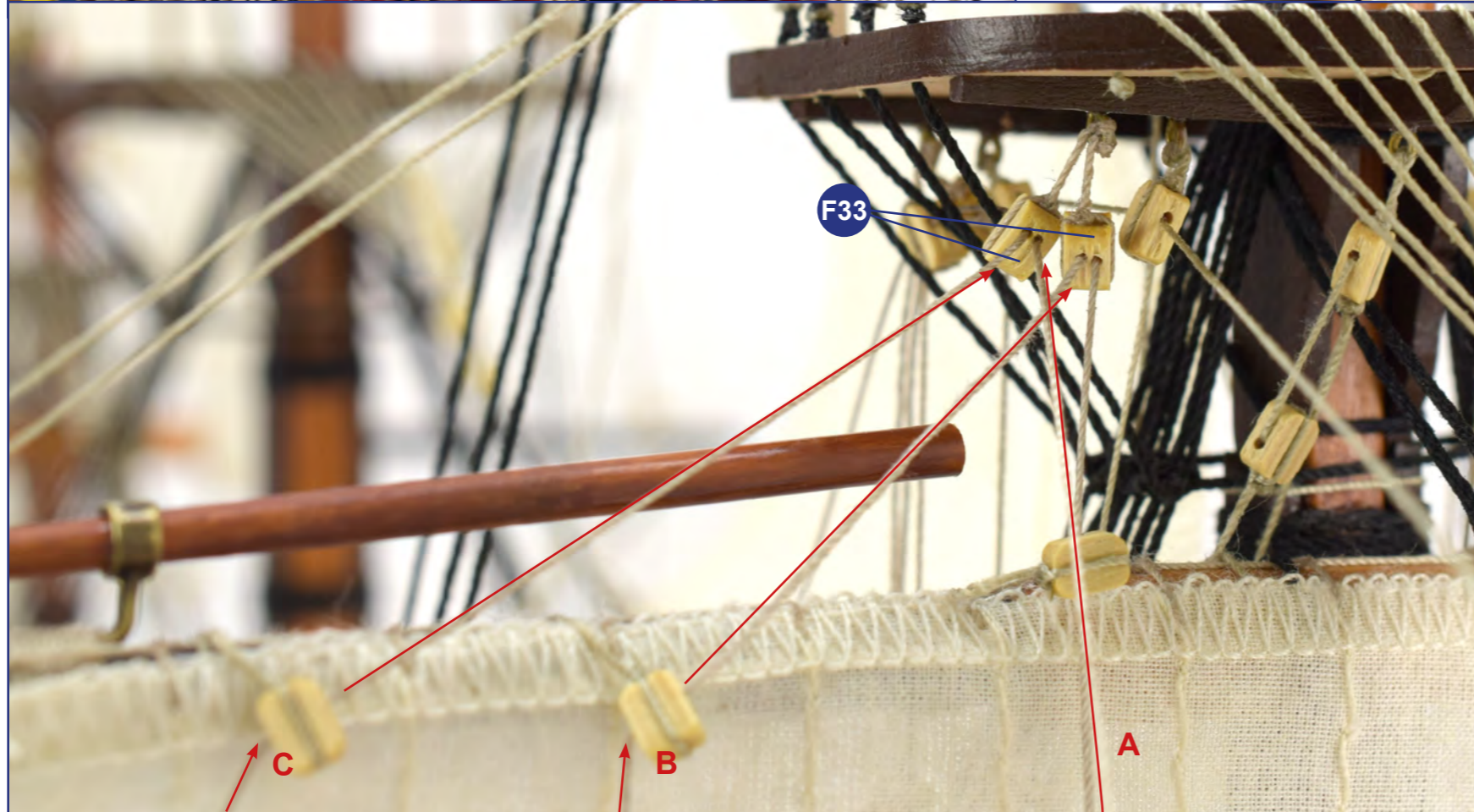
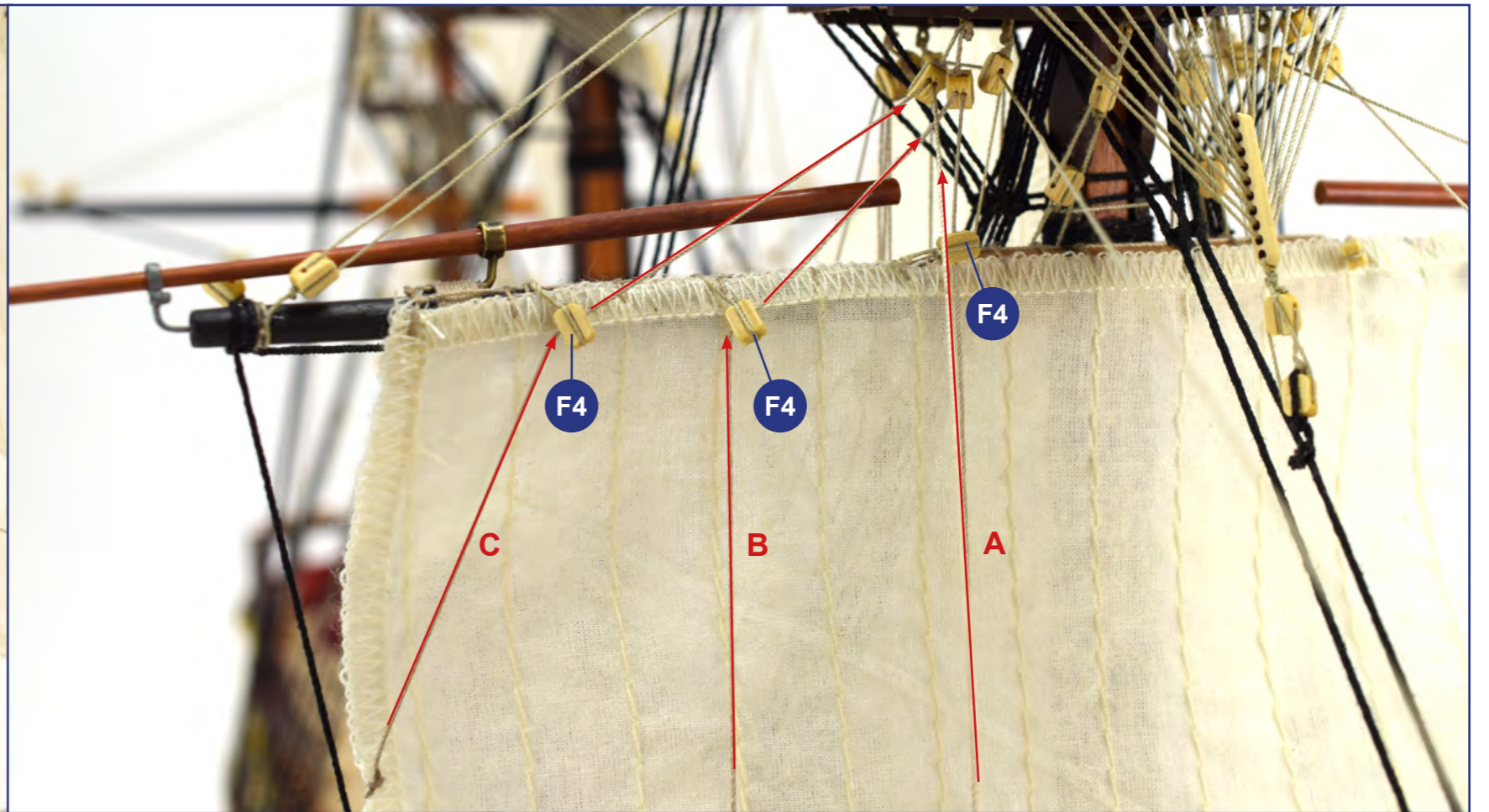
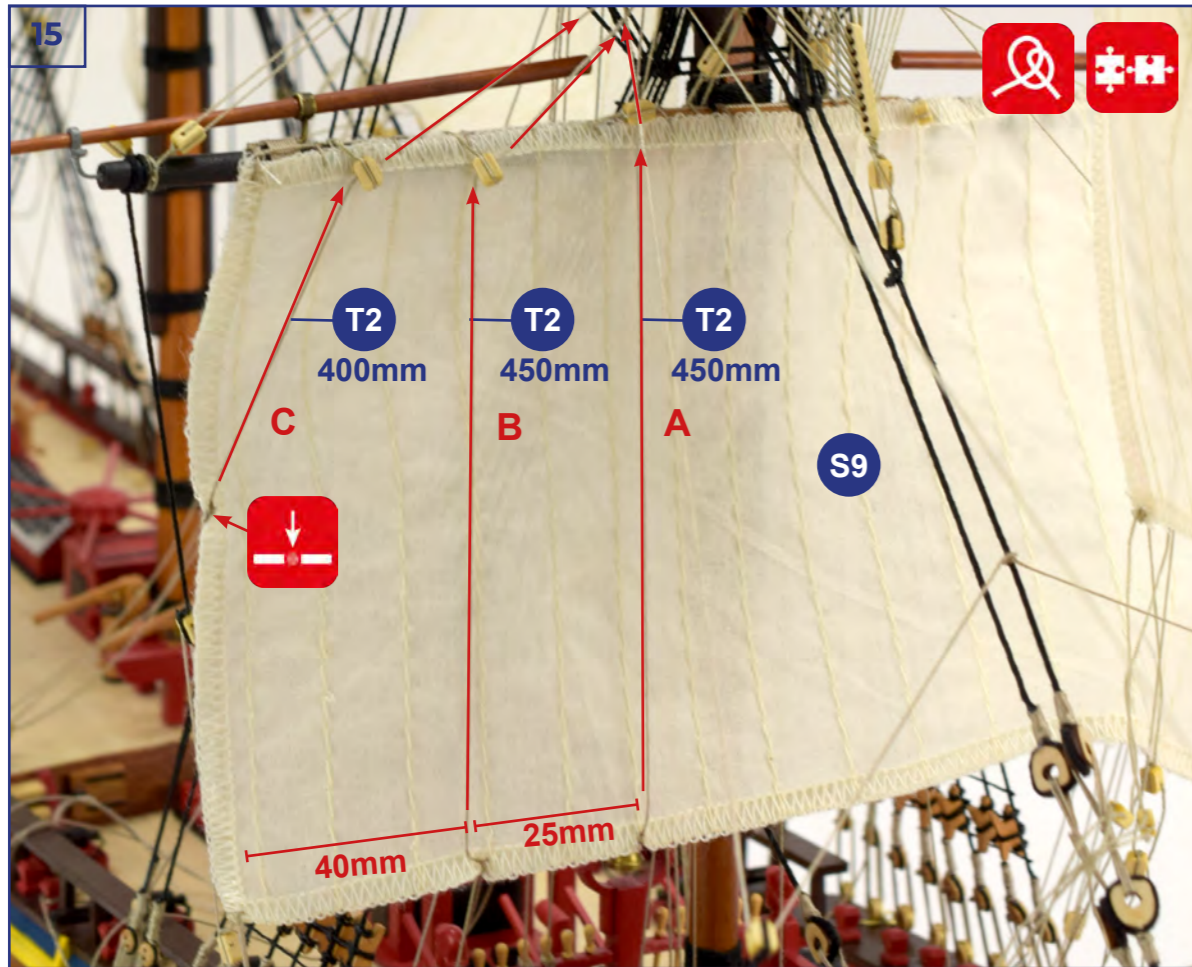

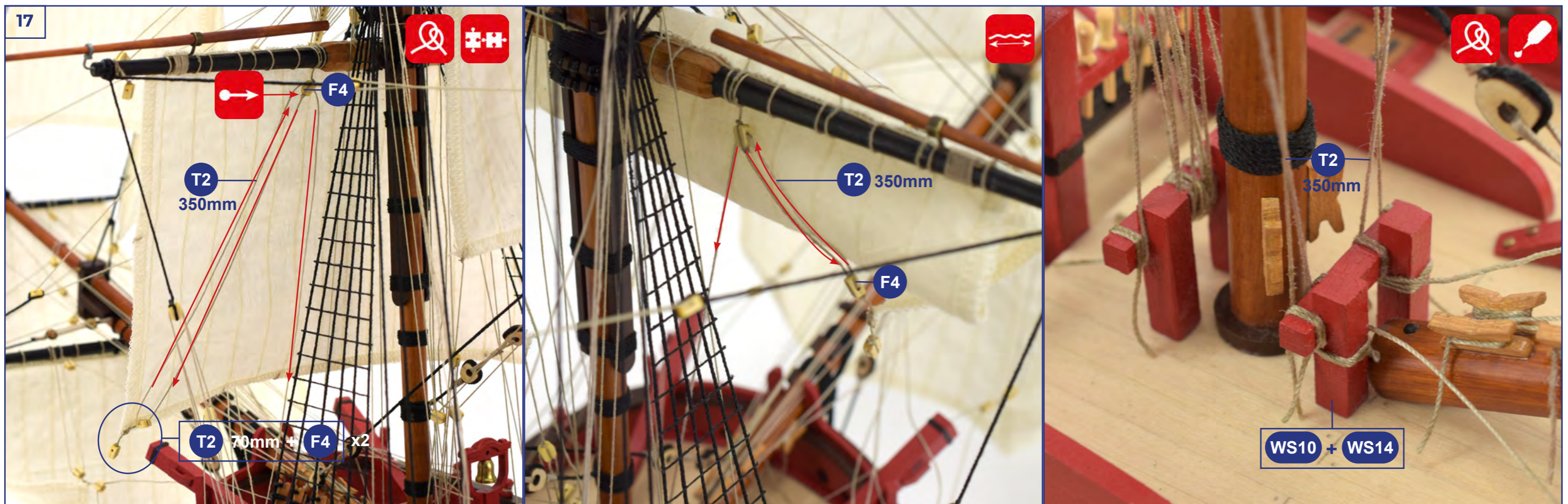
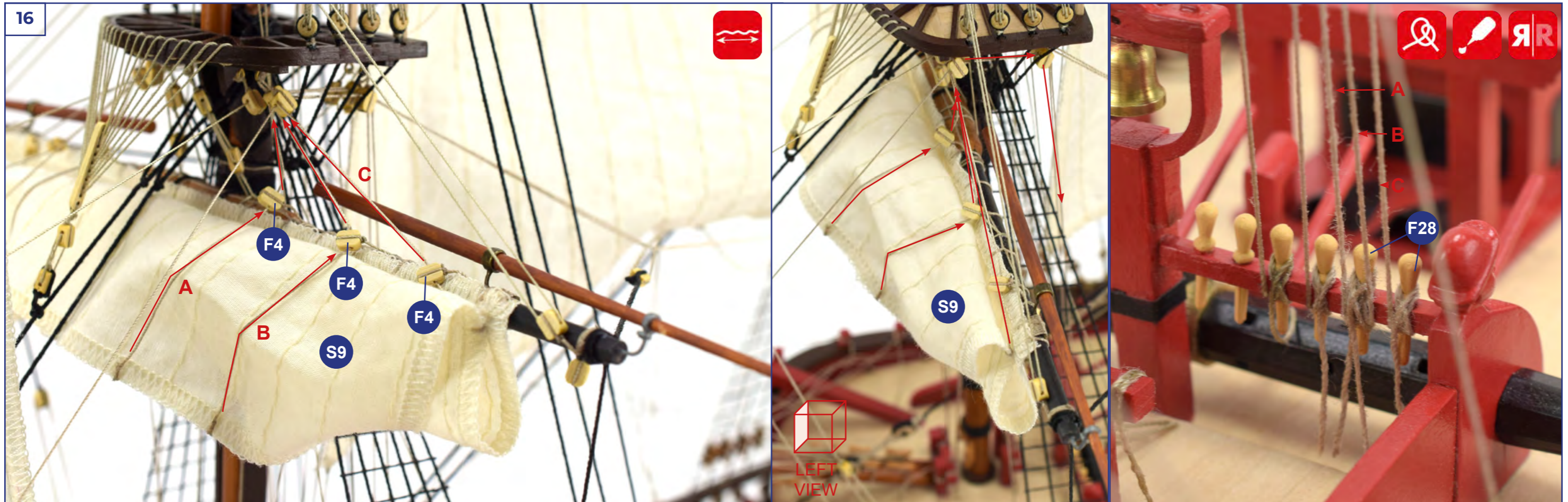

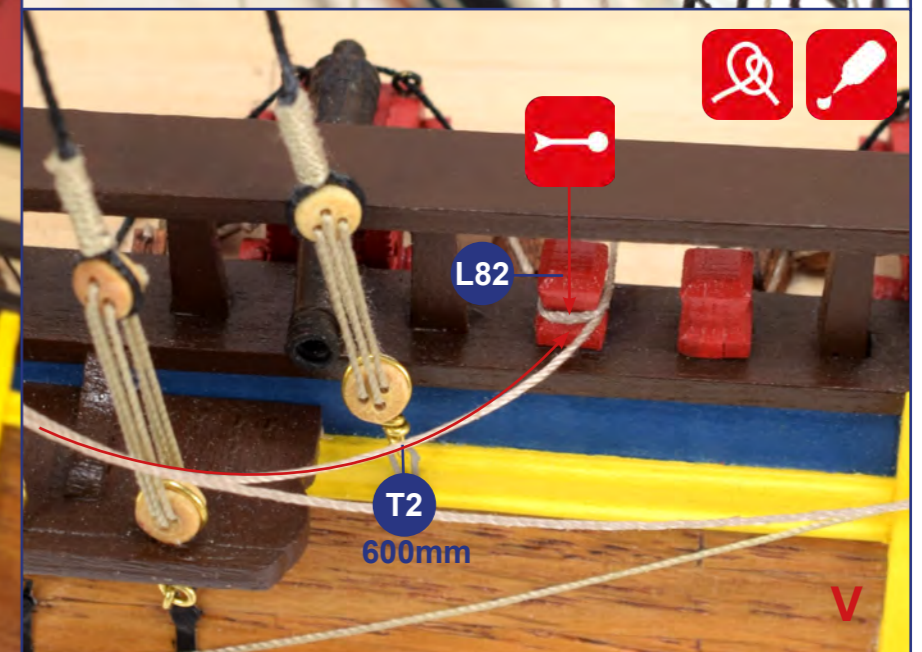
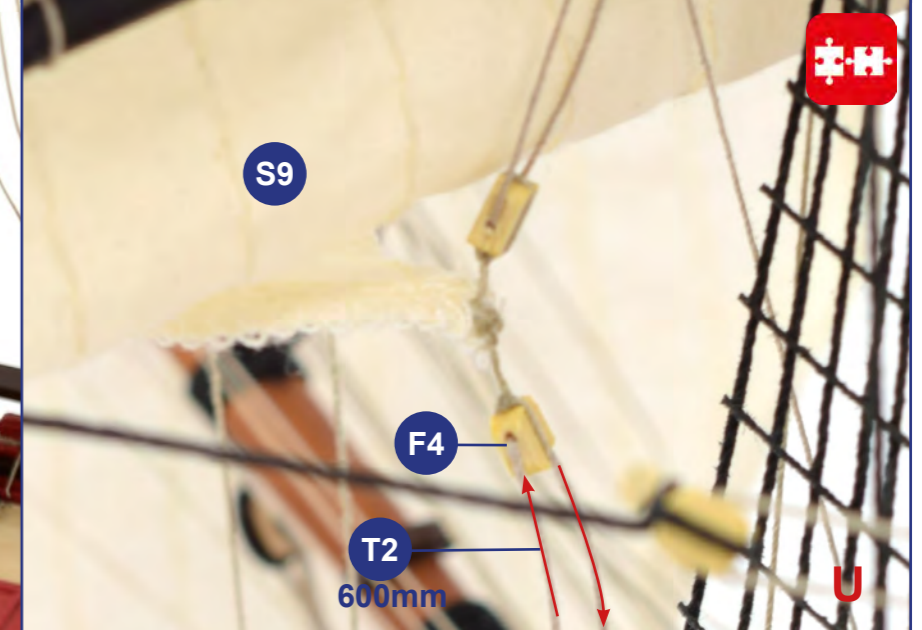
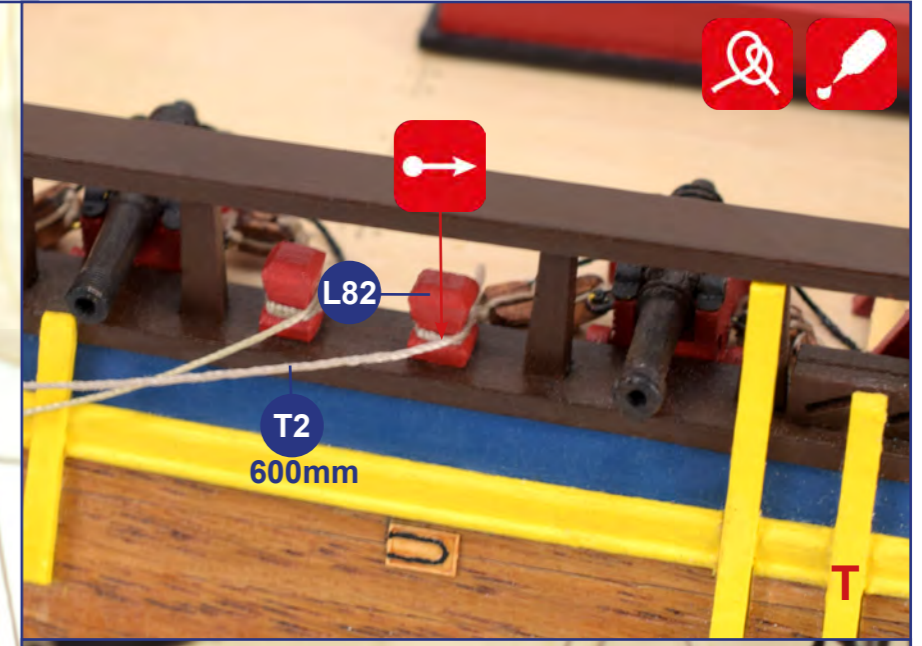
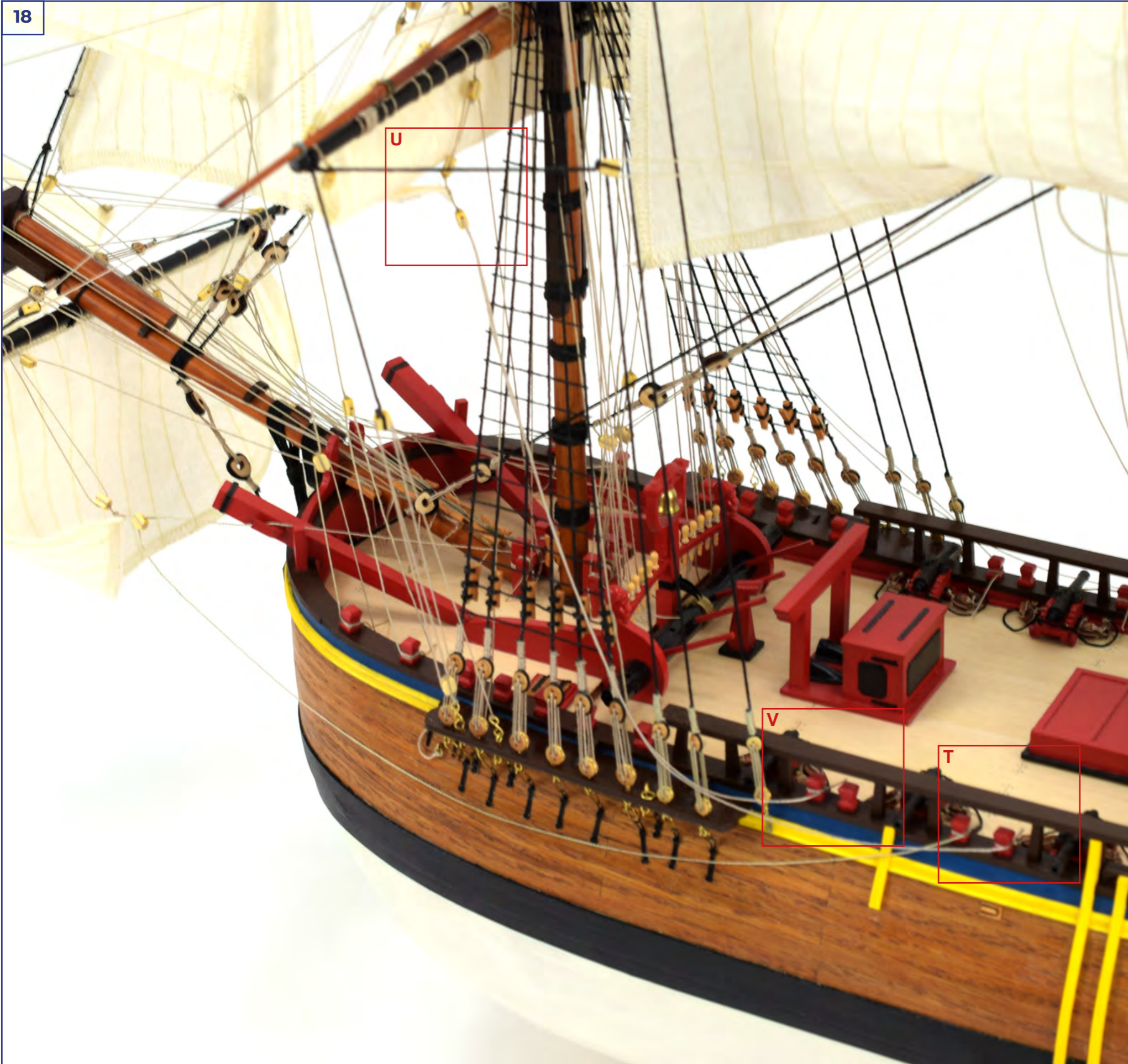

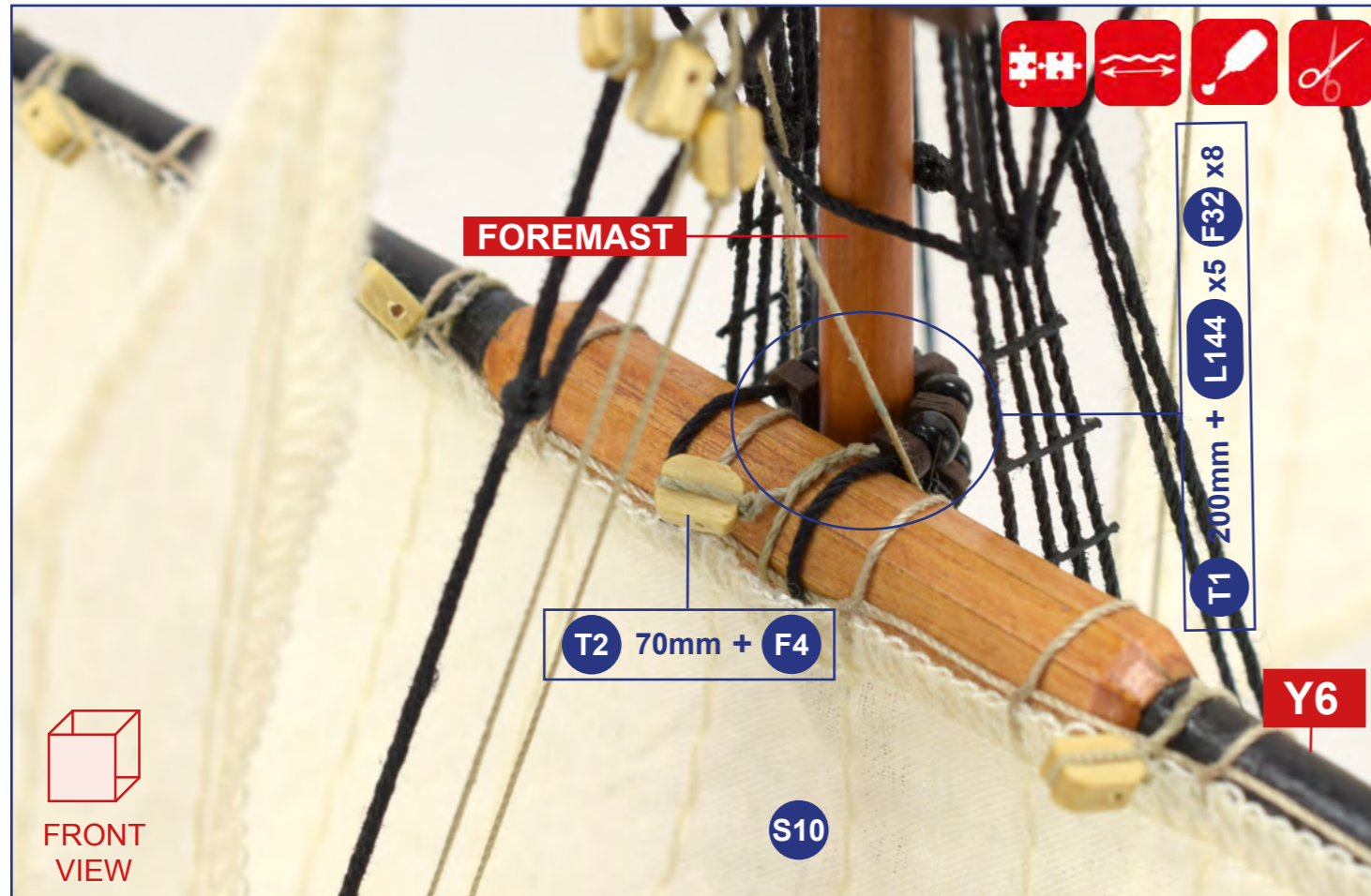

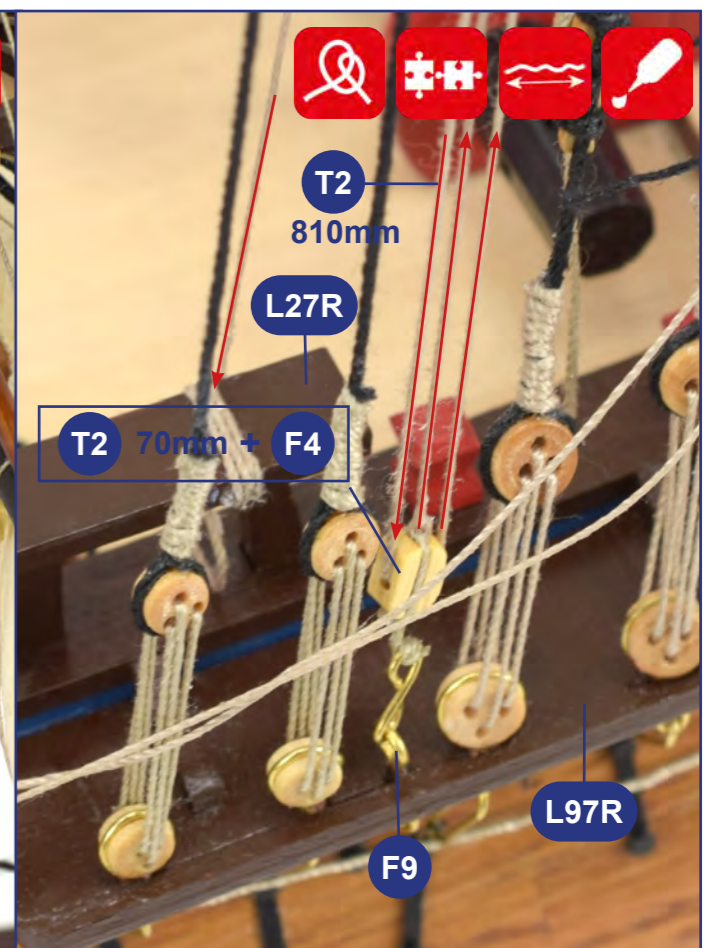
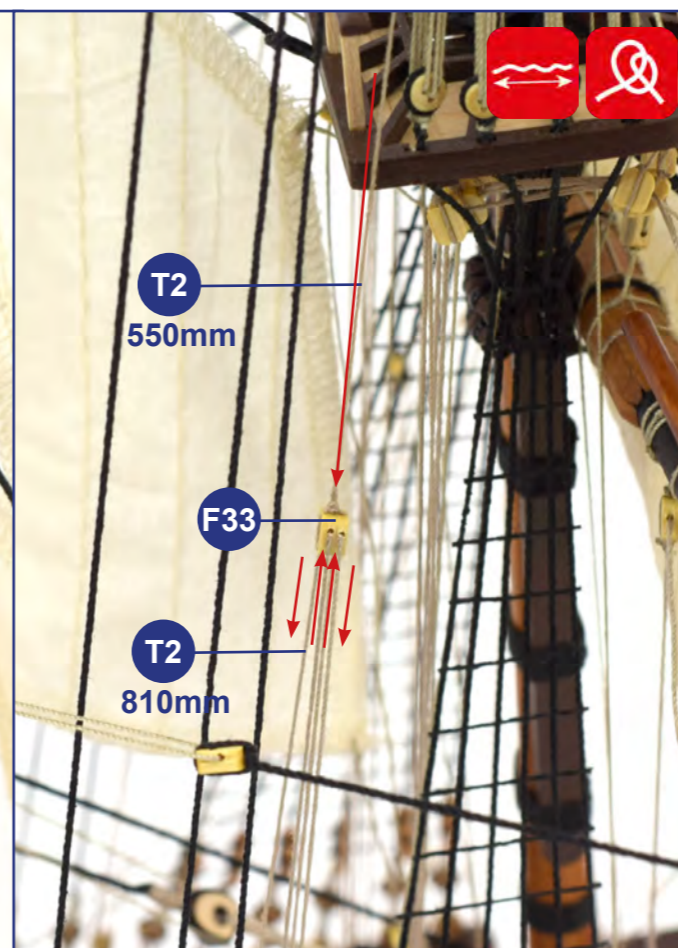
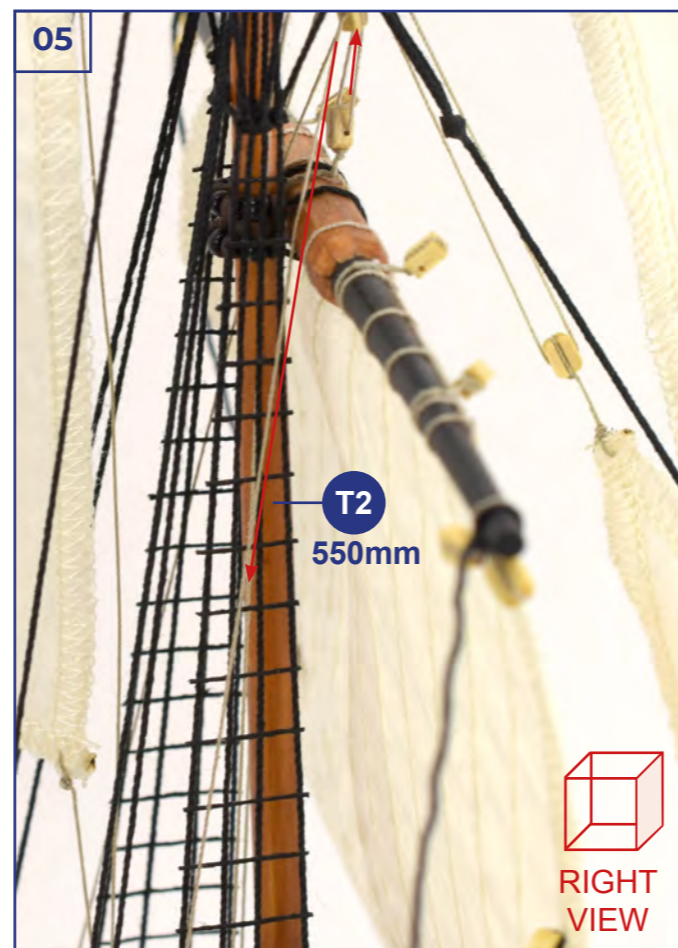
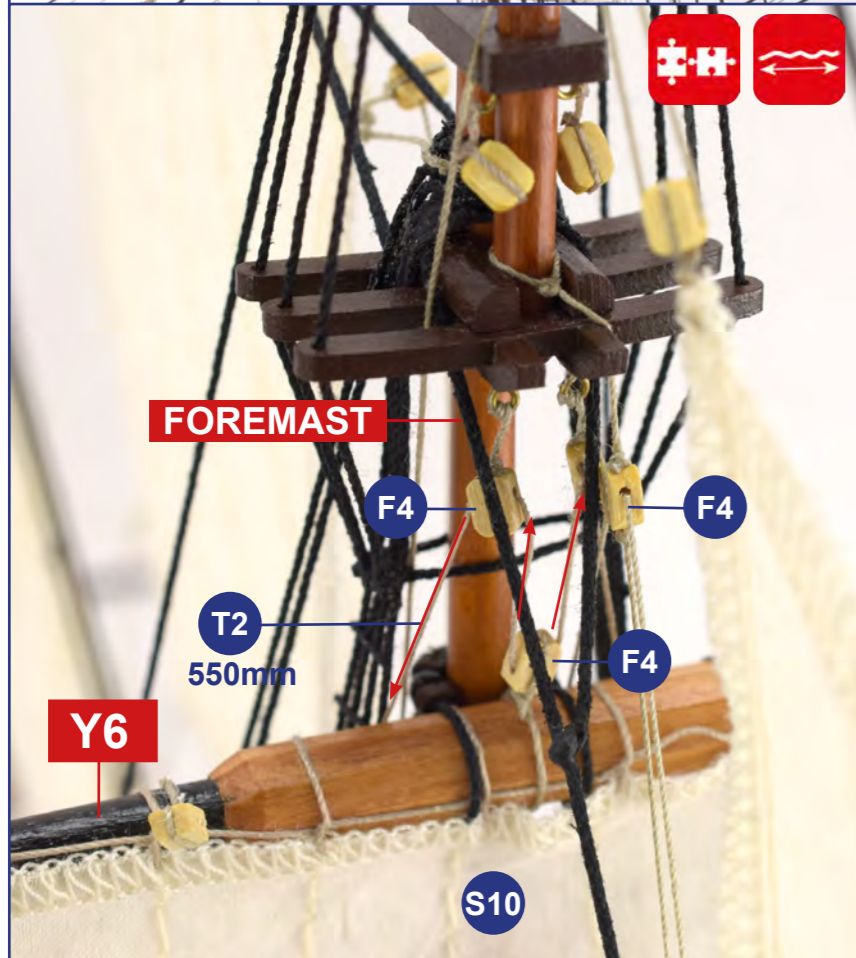
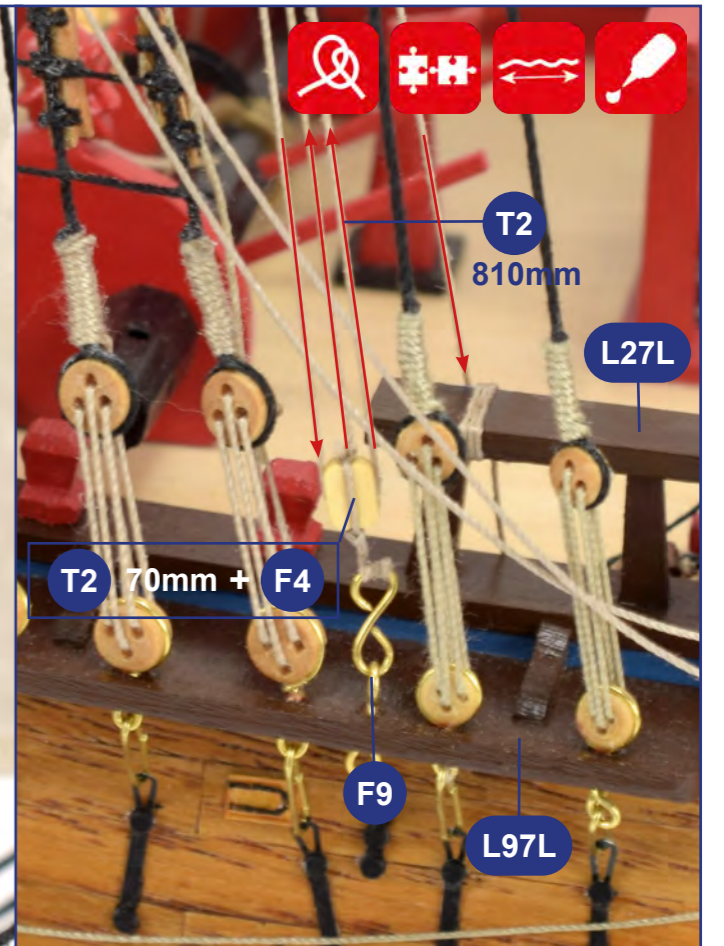
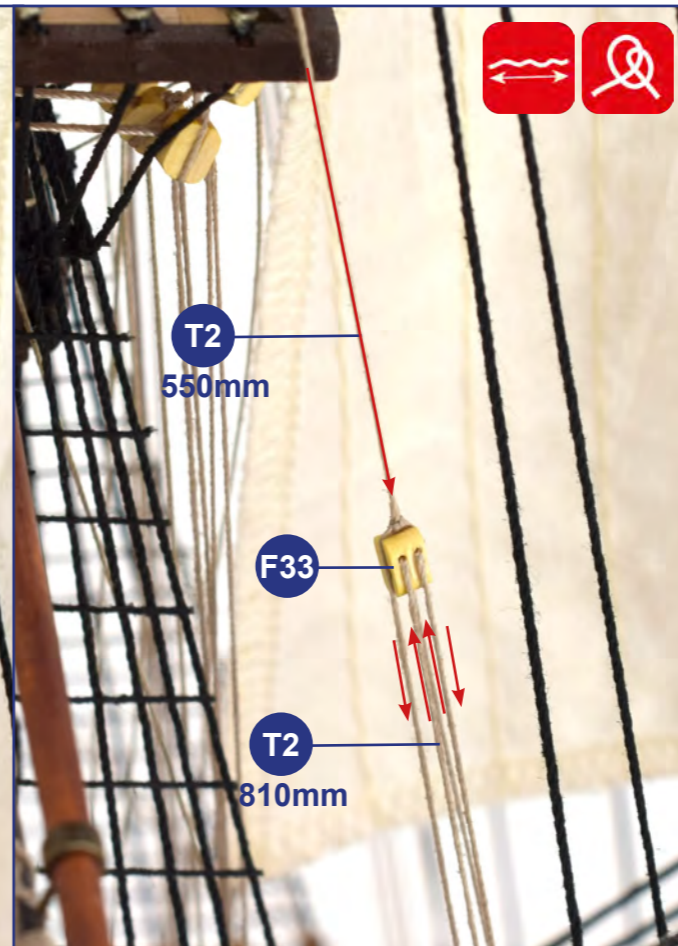
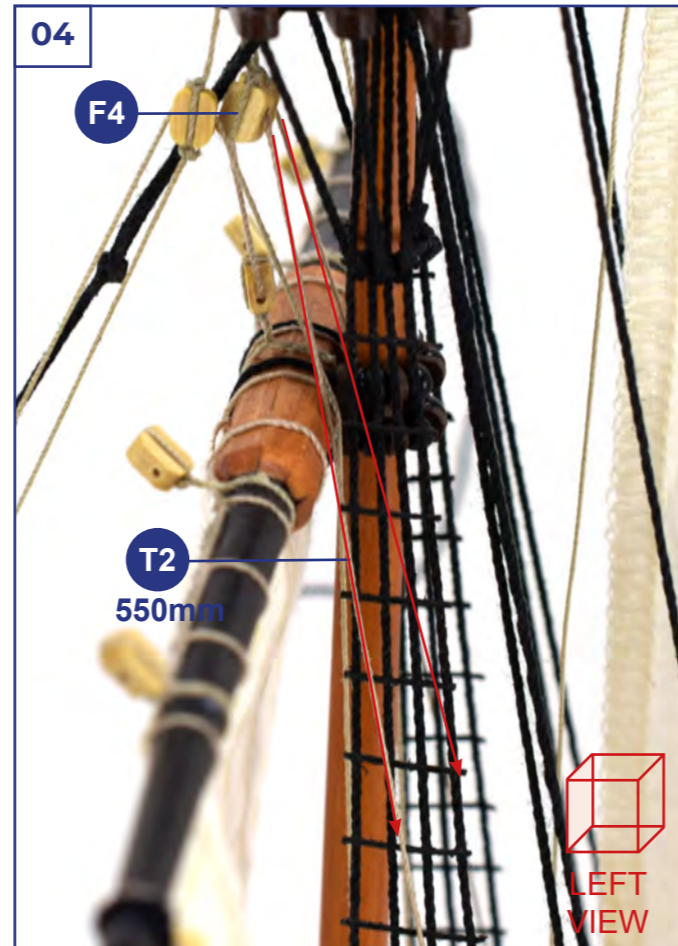
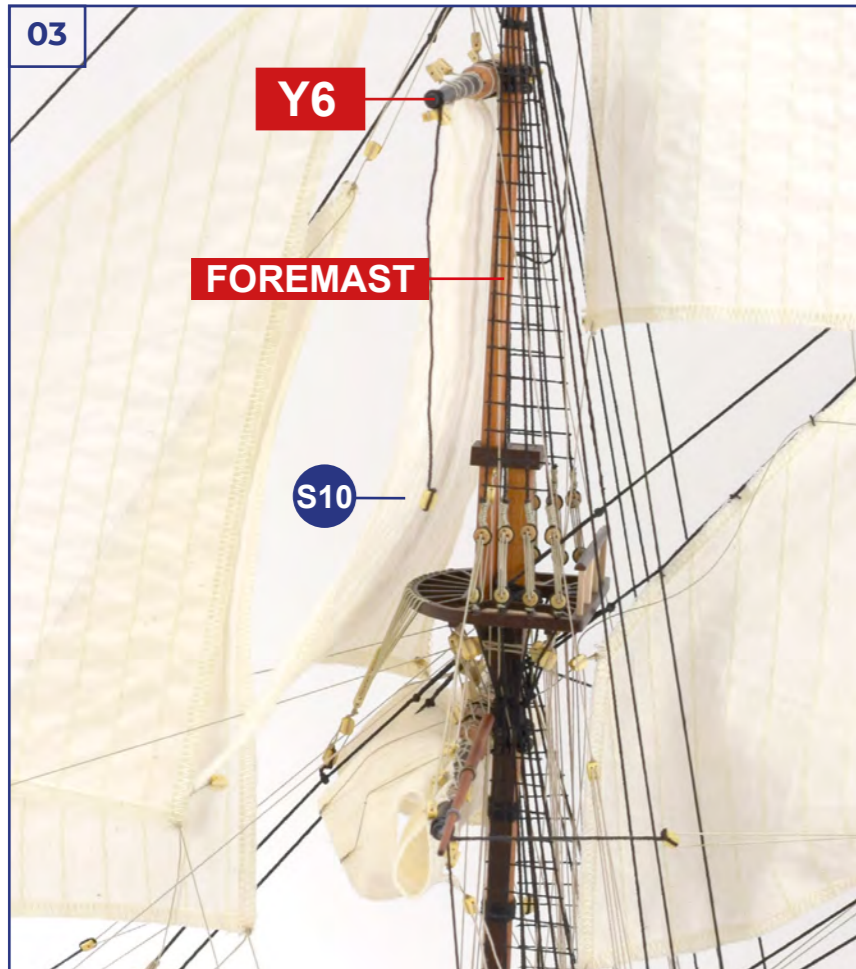

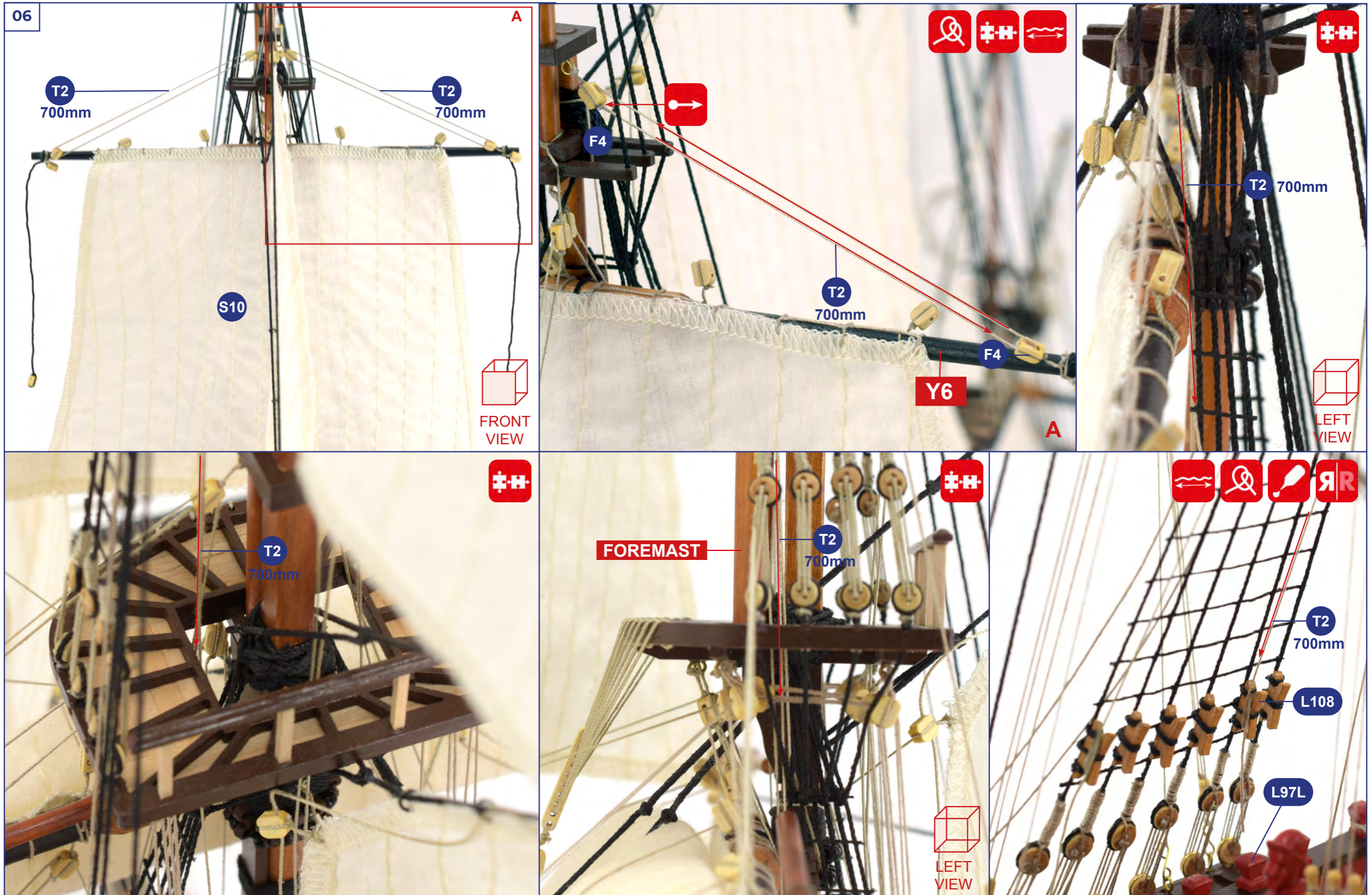

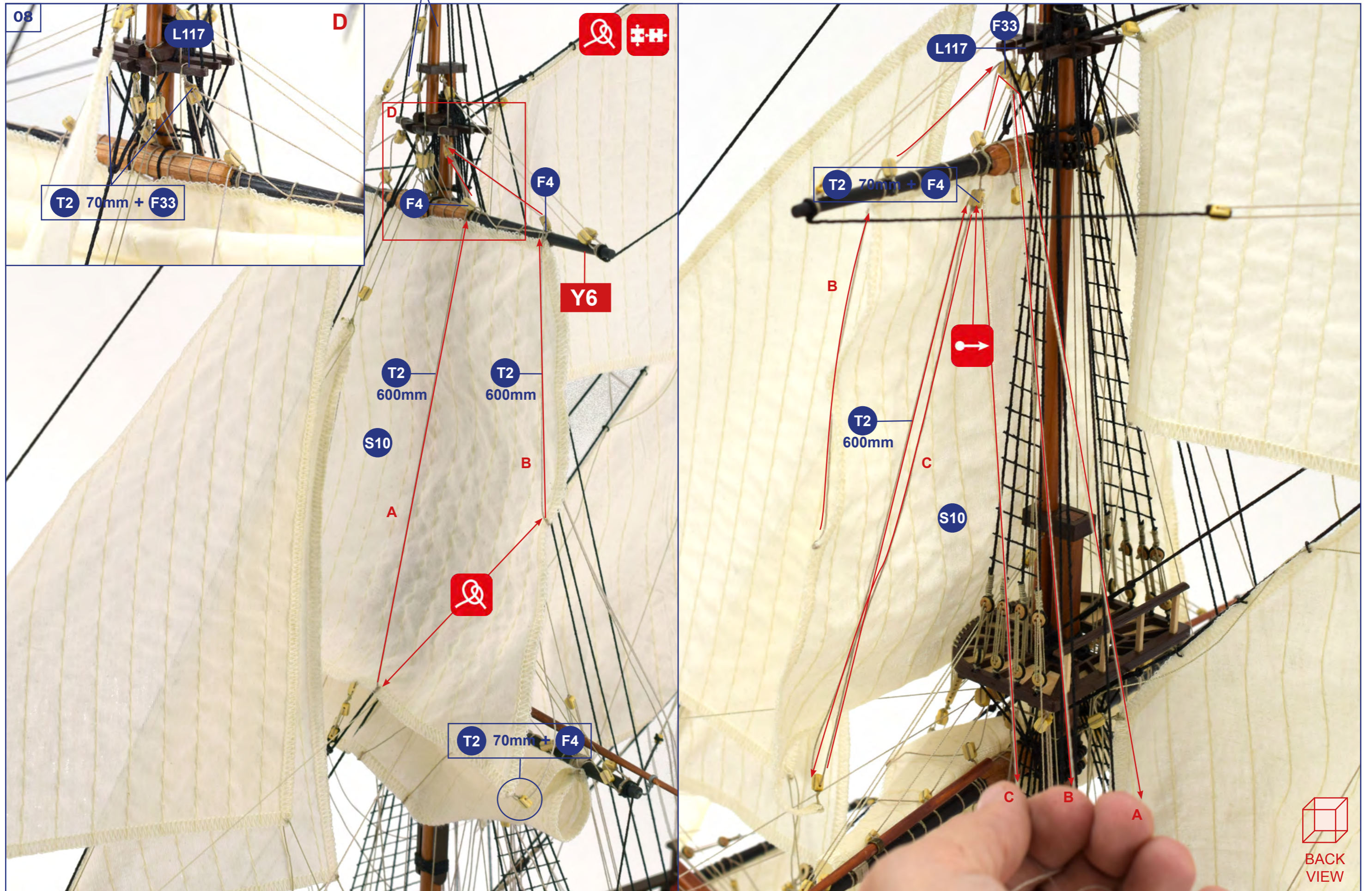

09

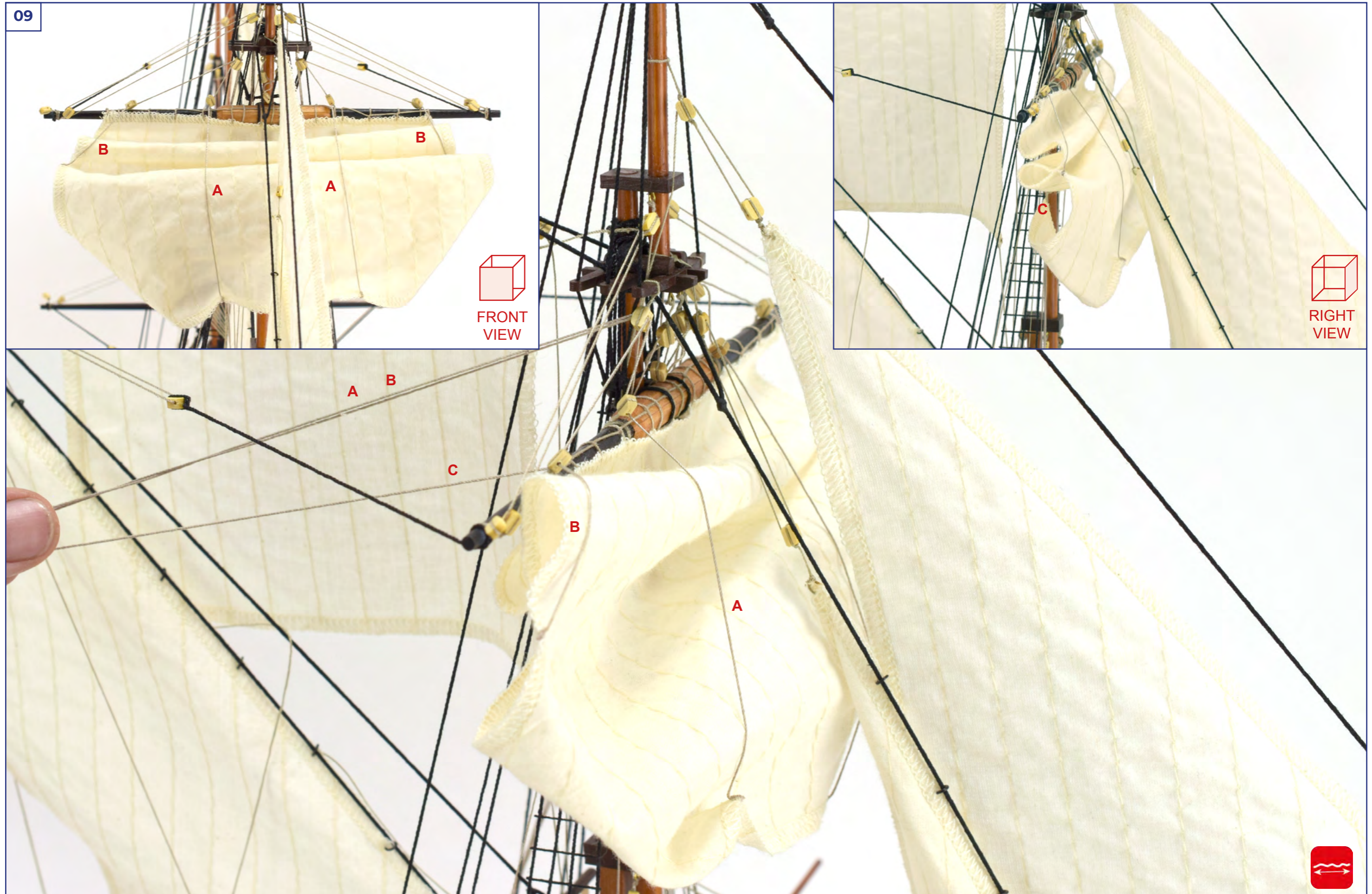

10



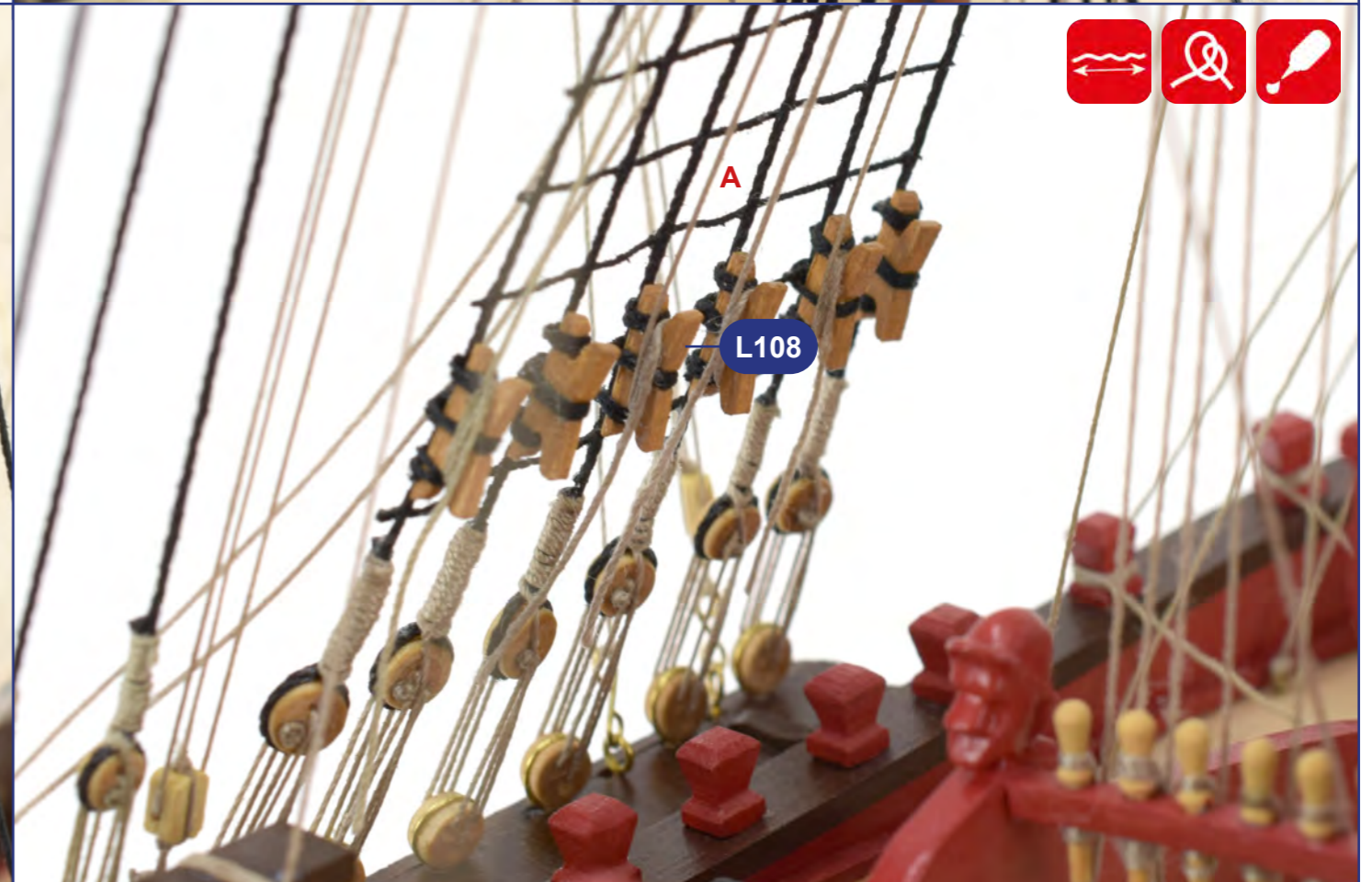
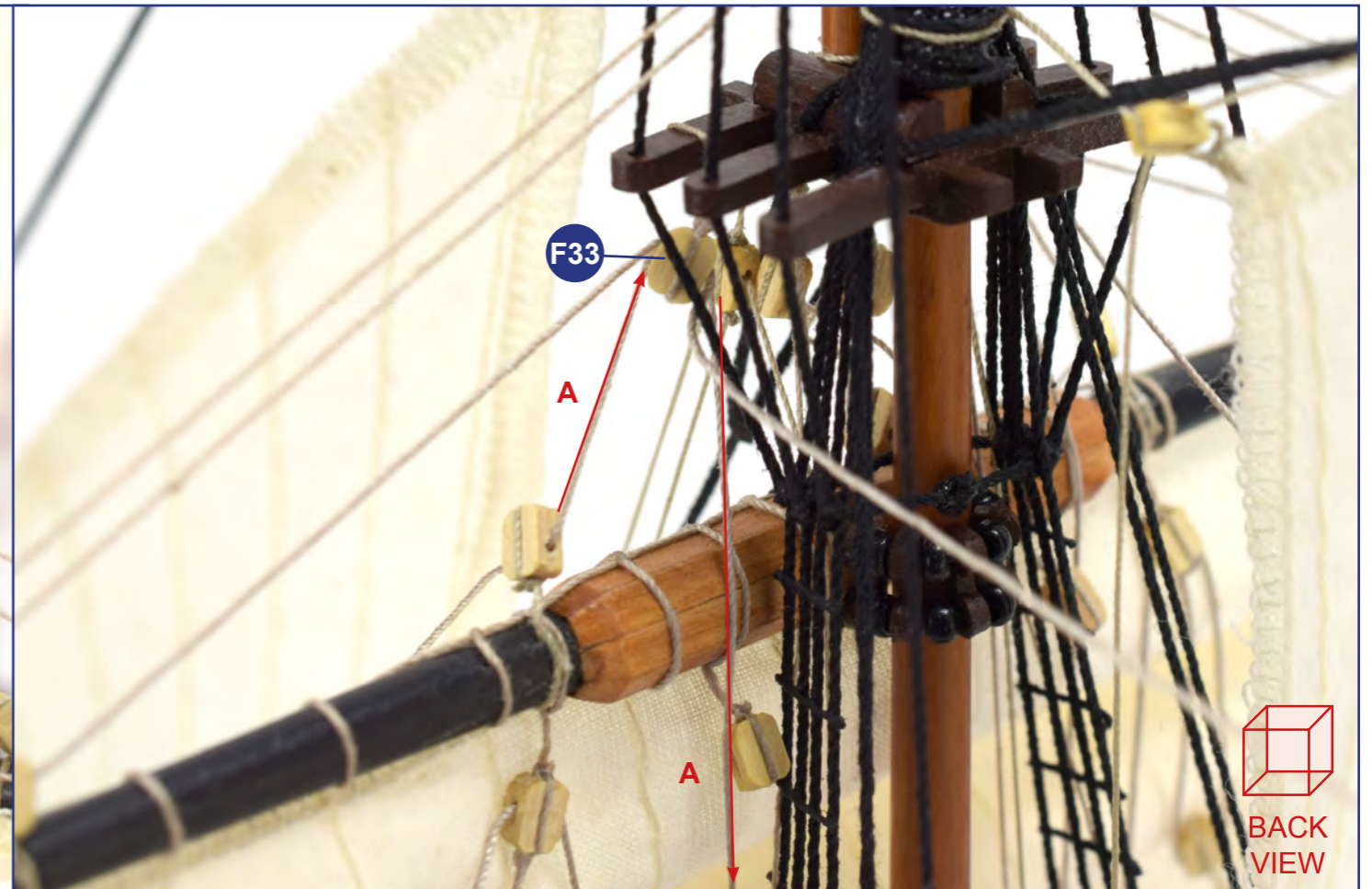
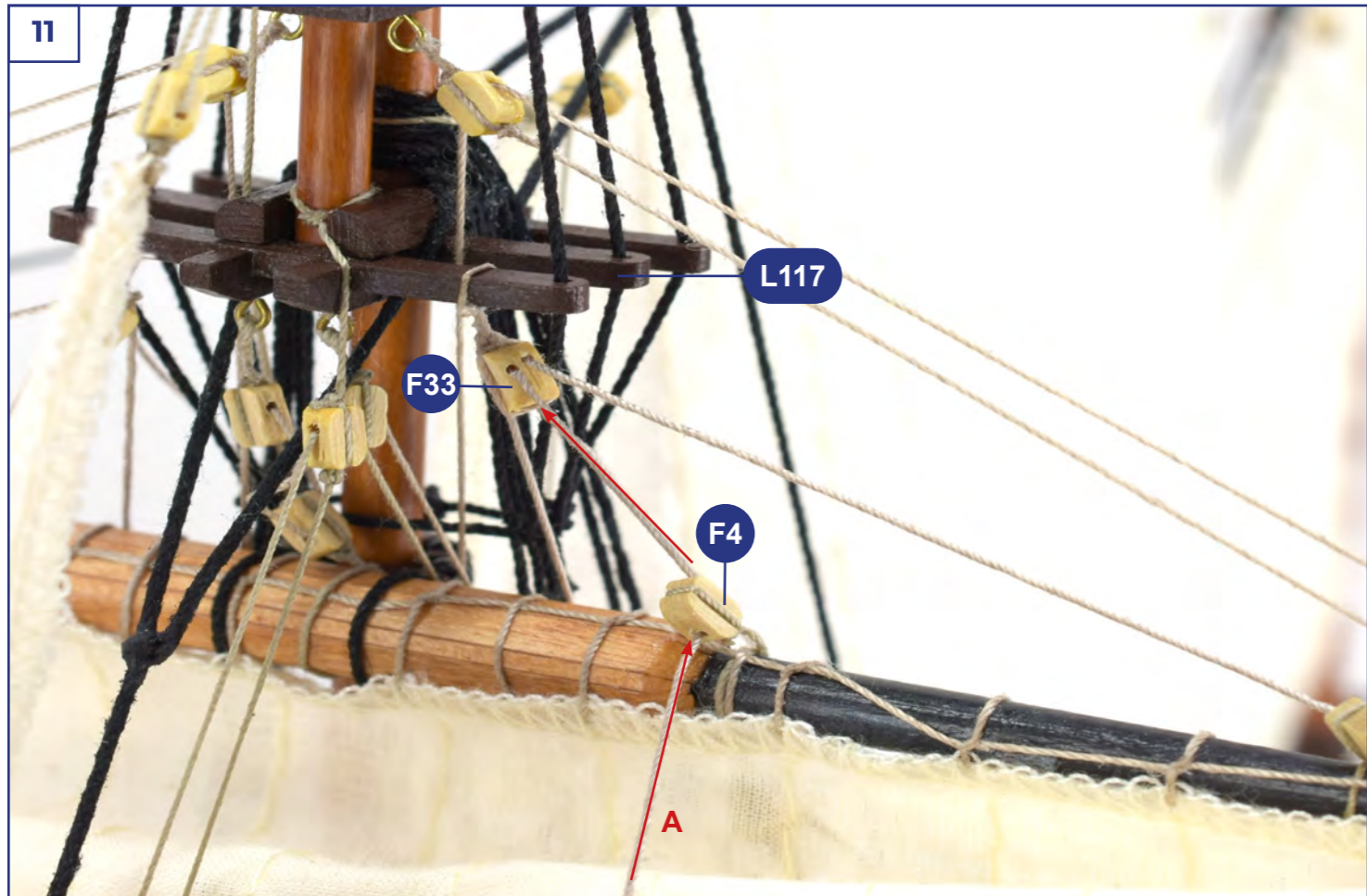

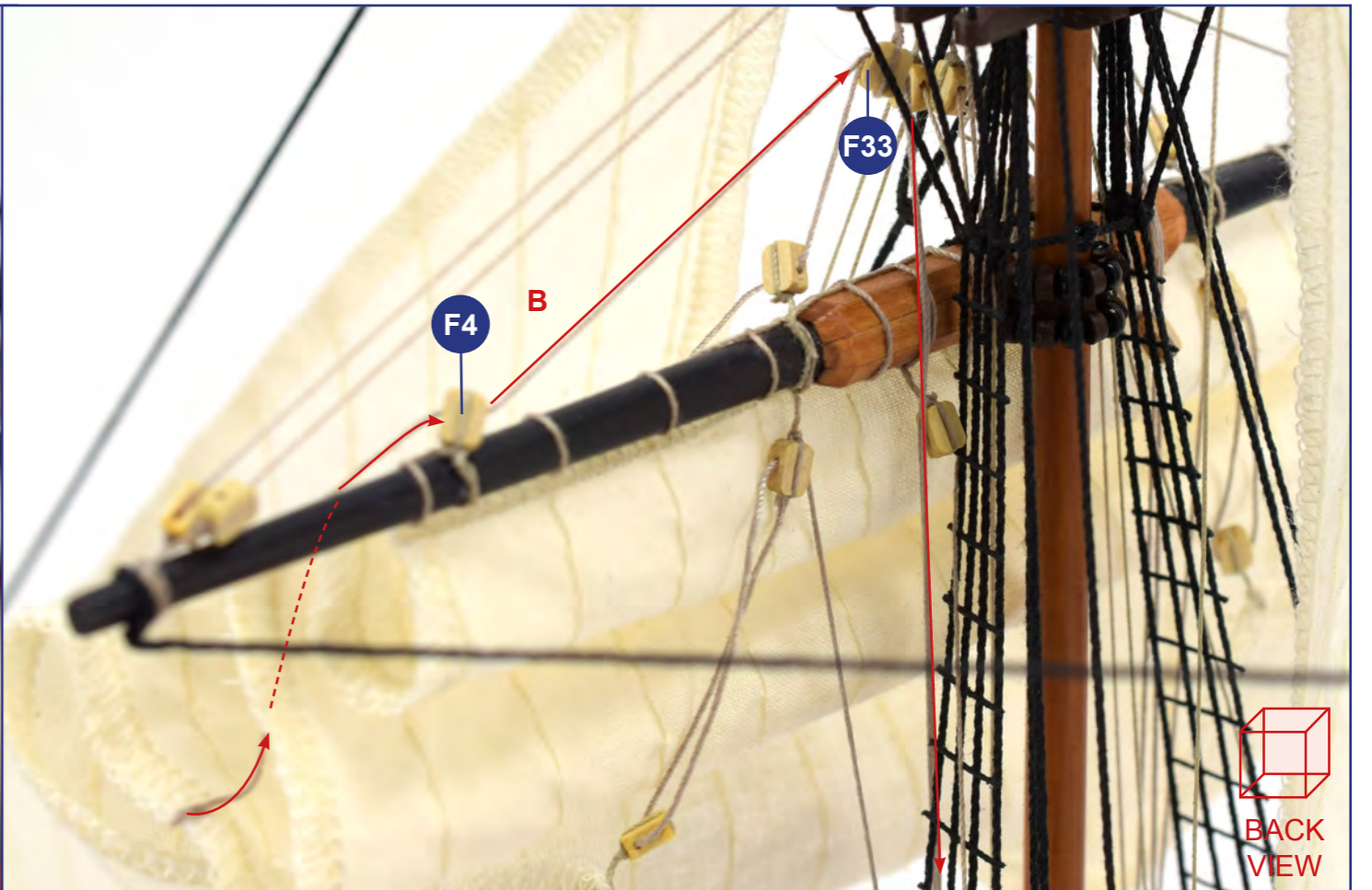
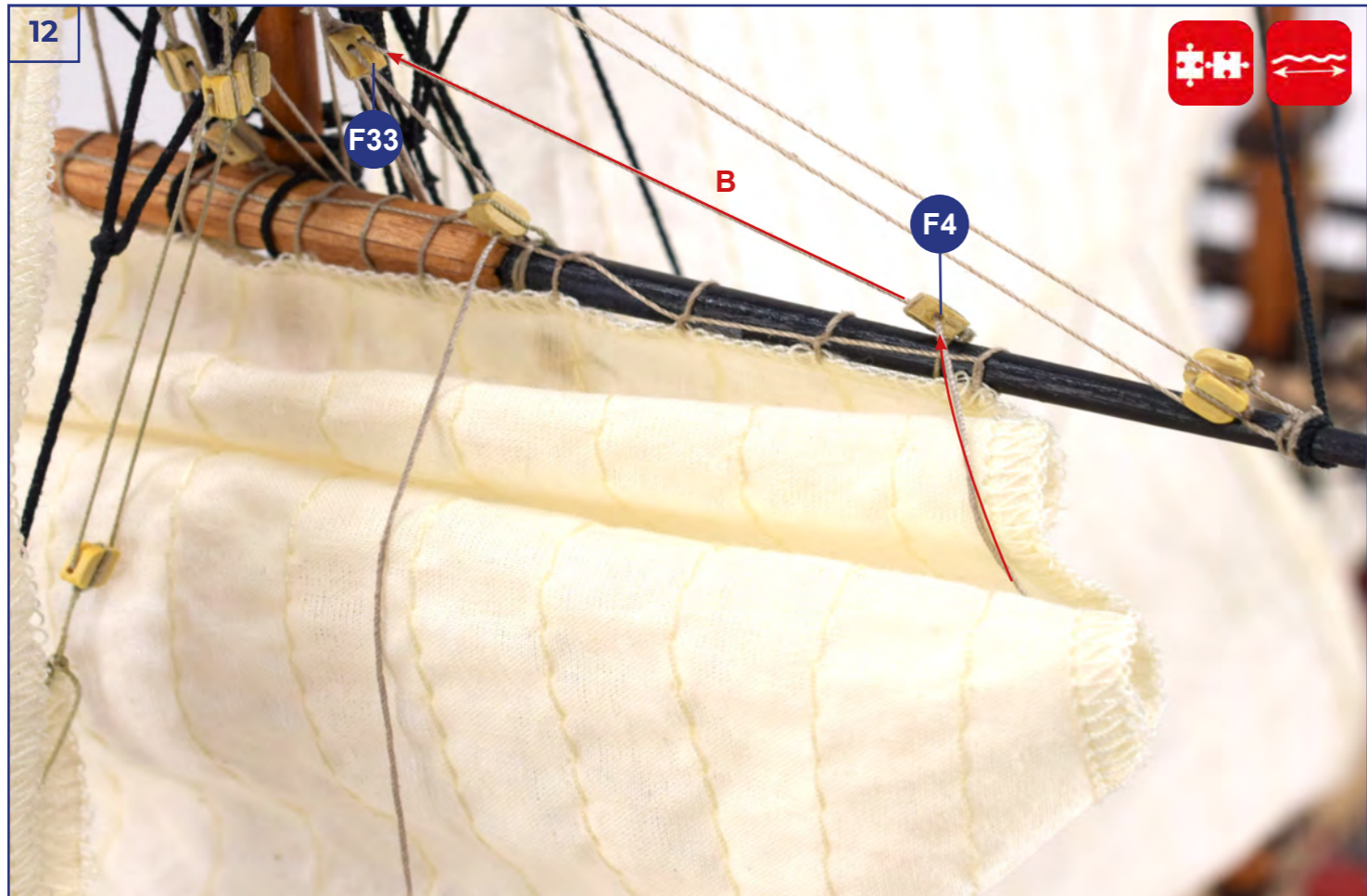

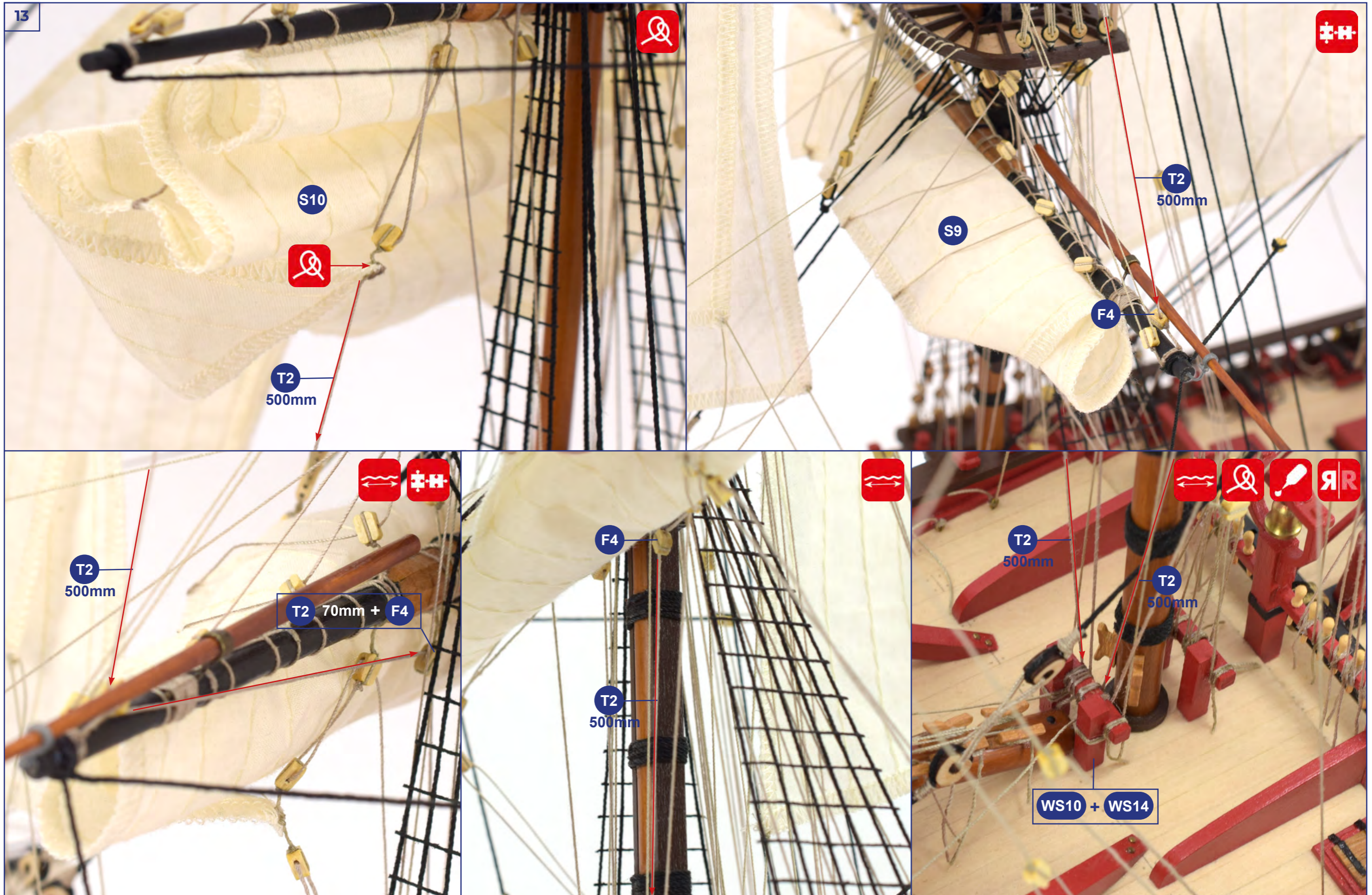

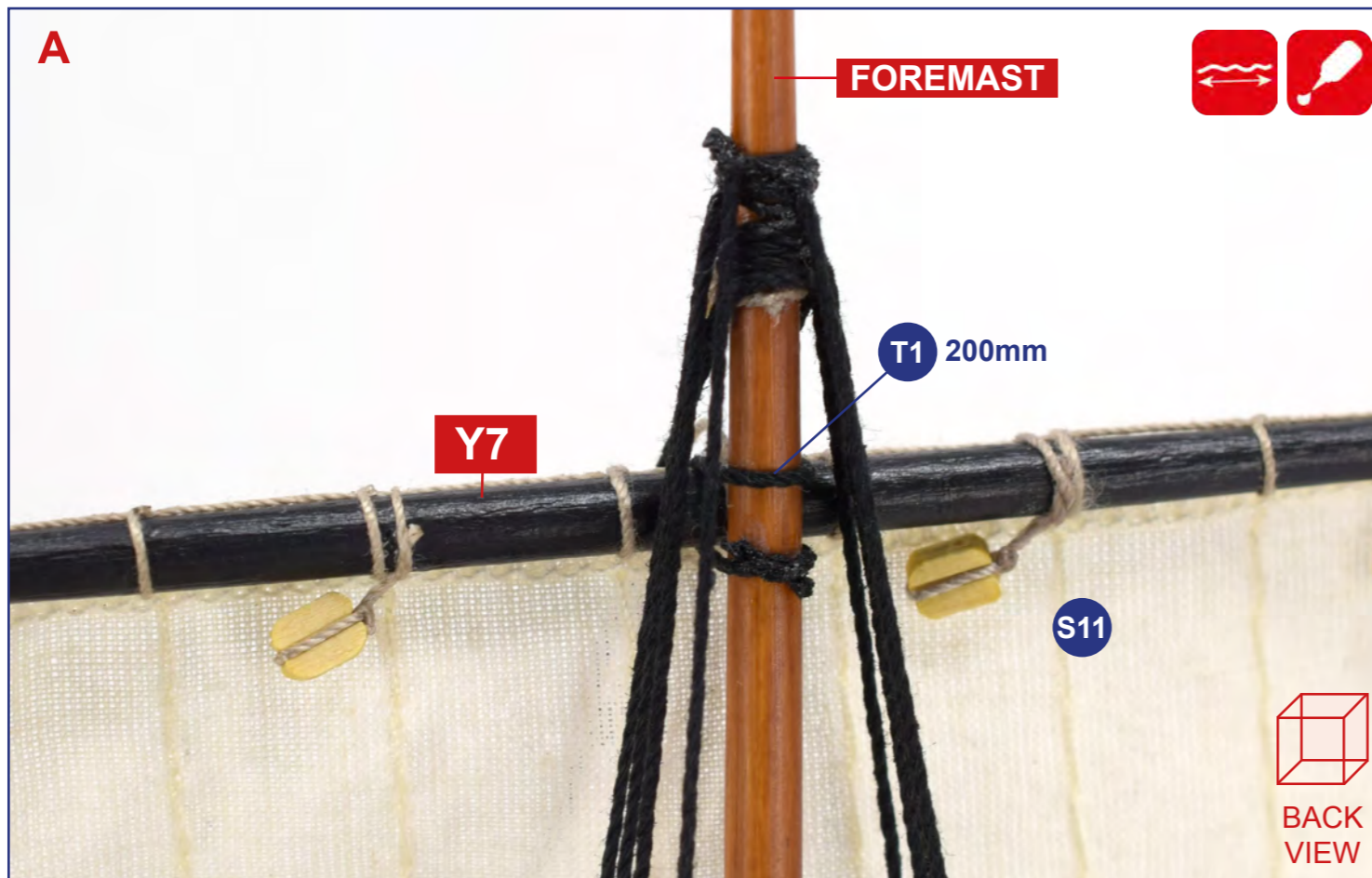
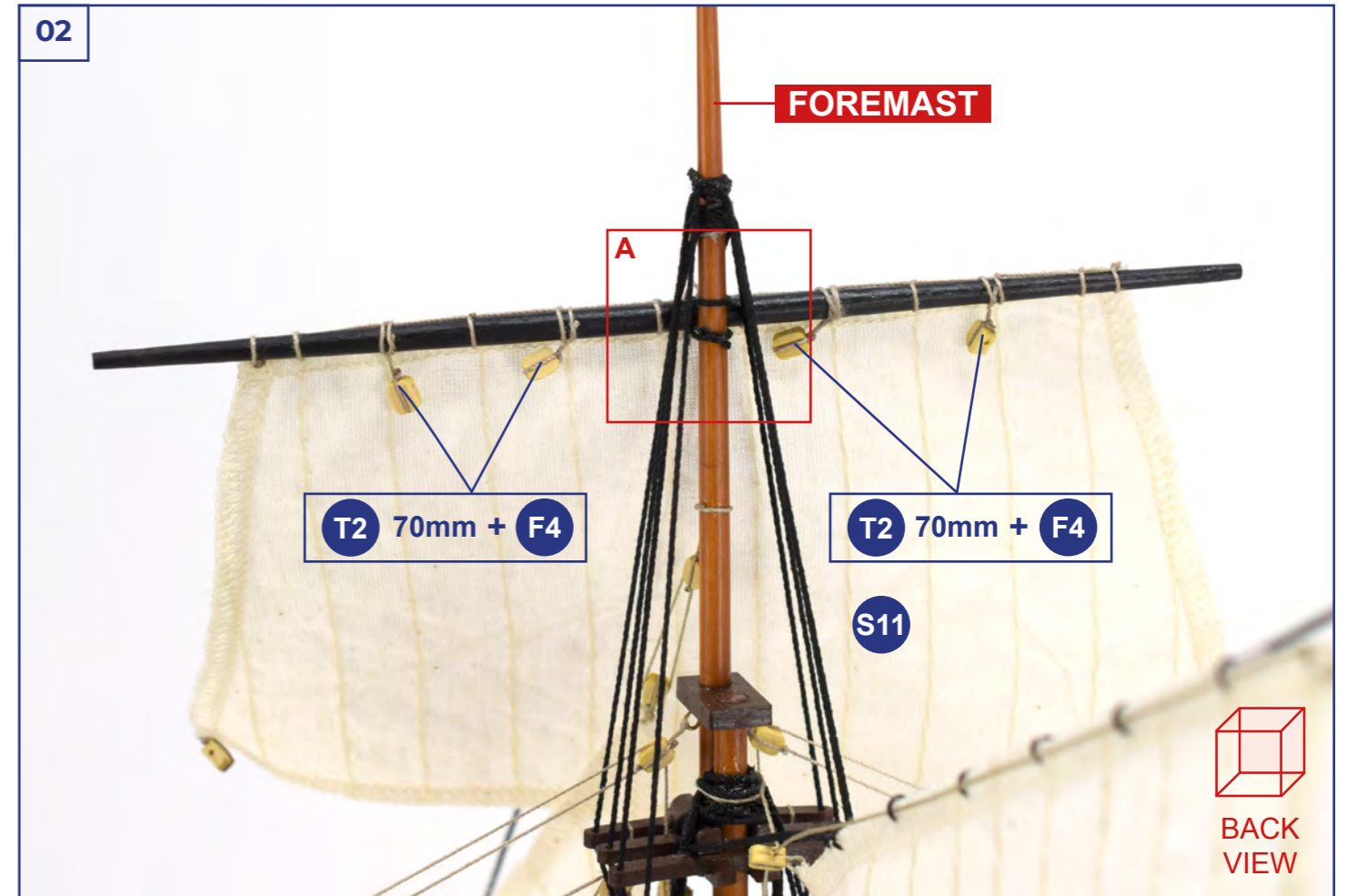

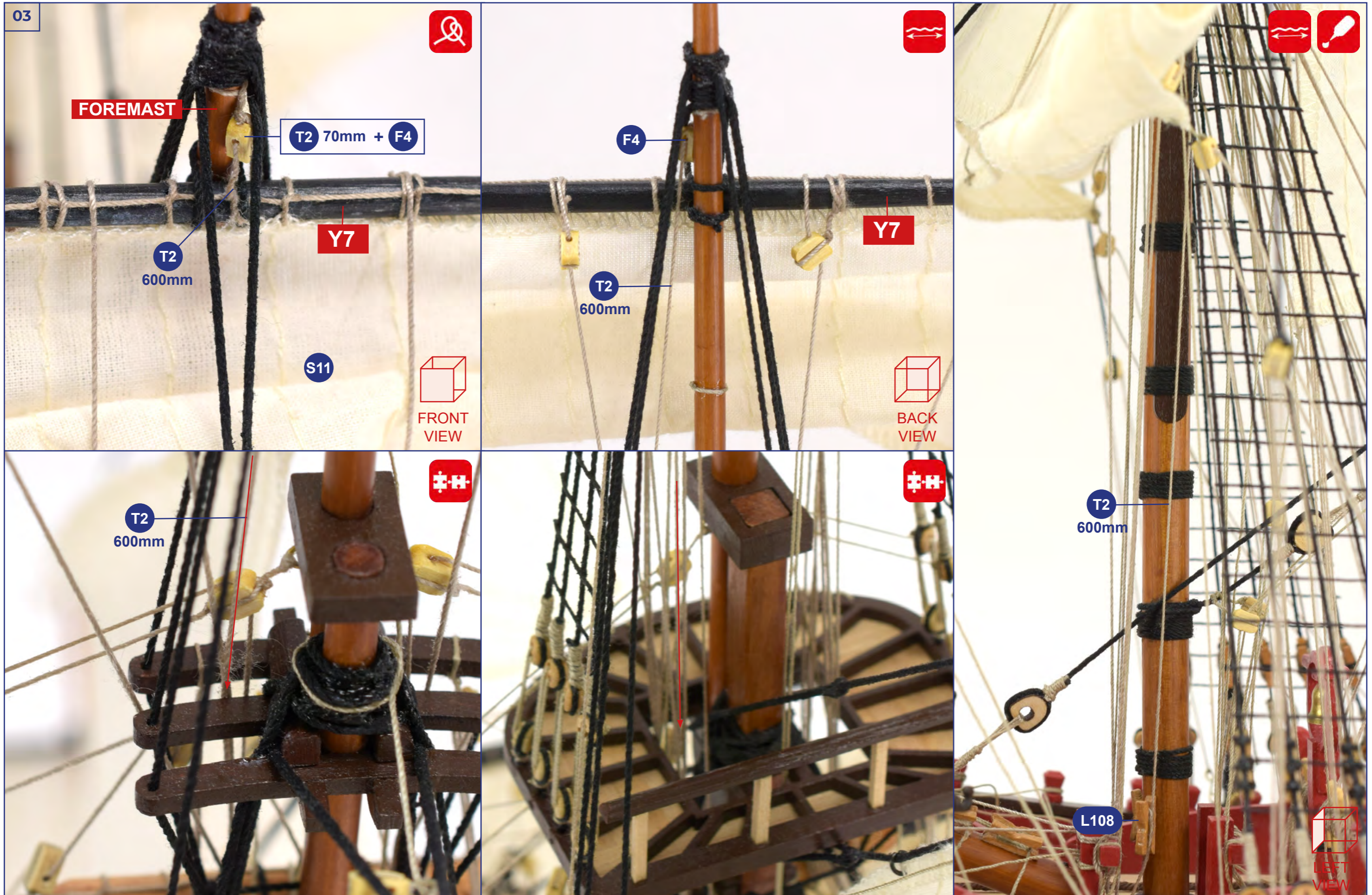

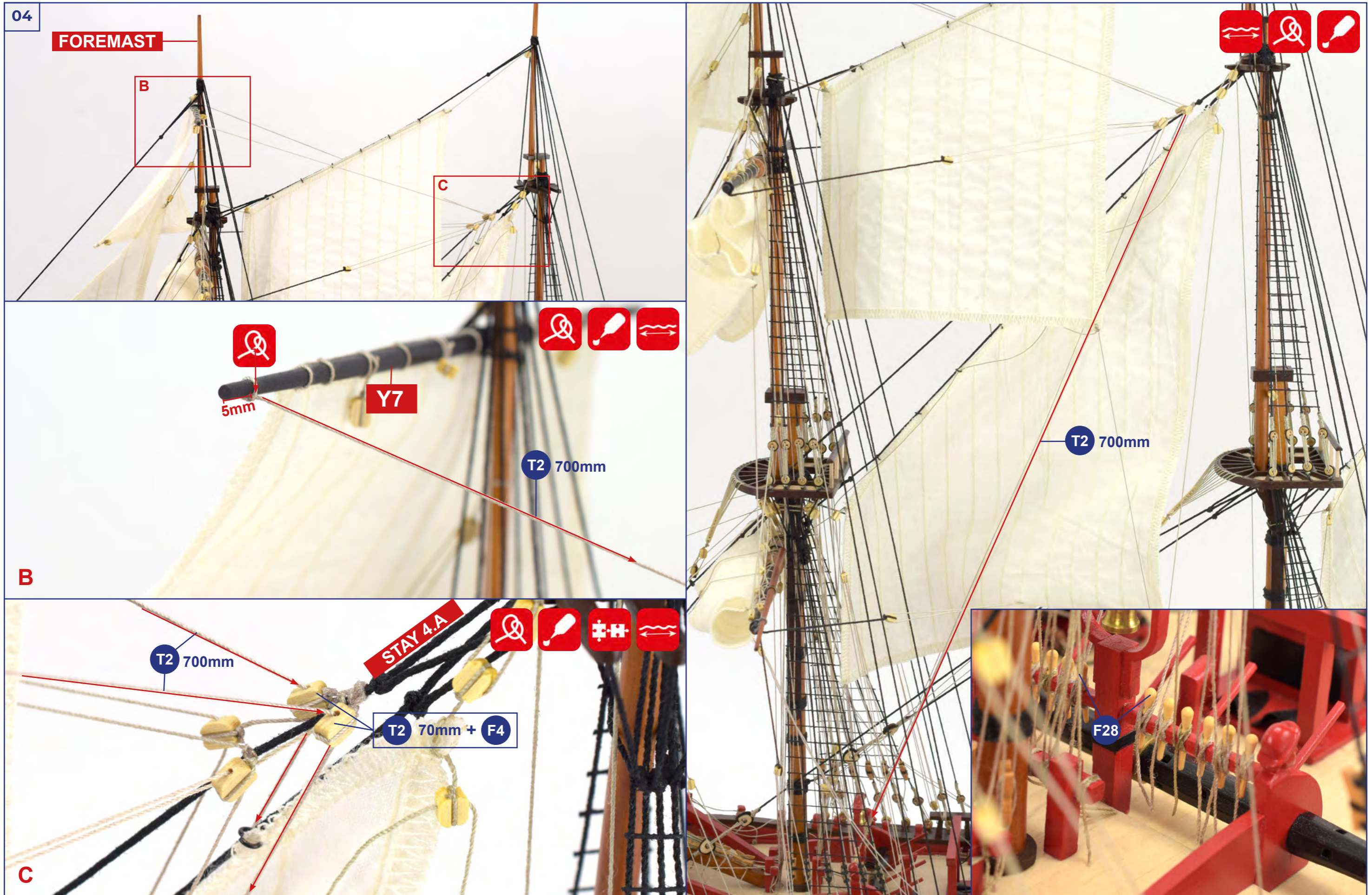

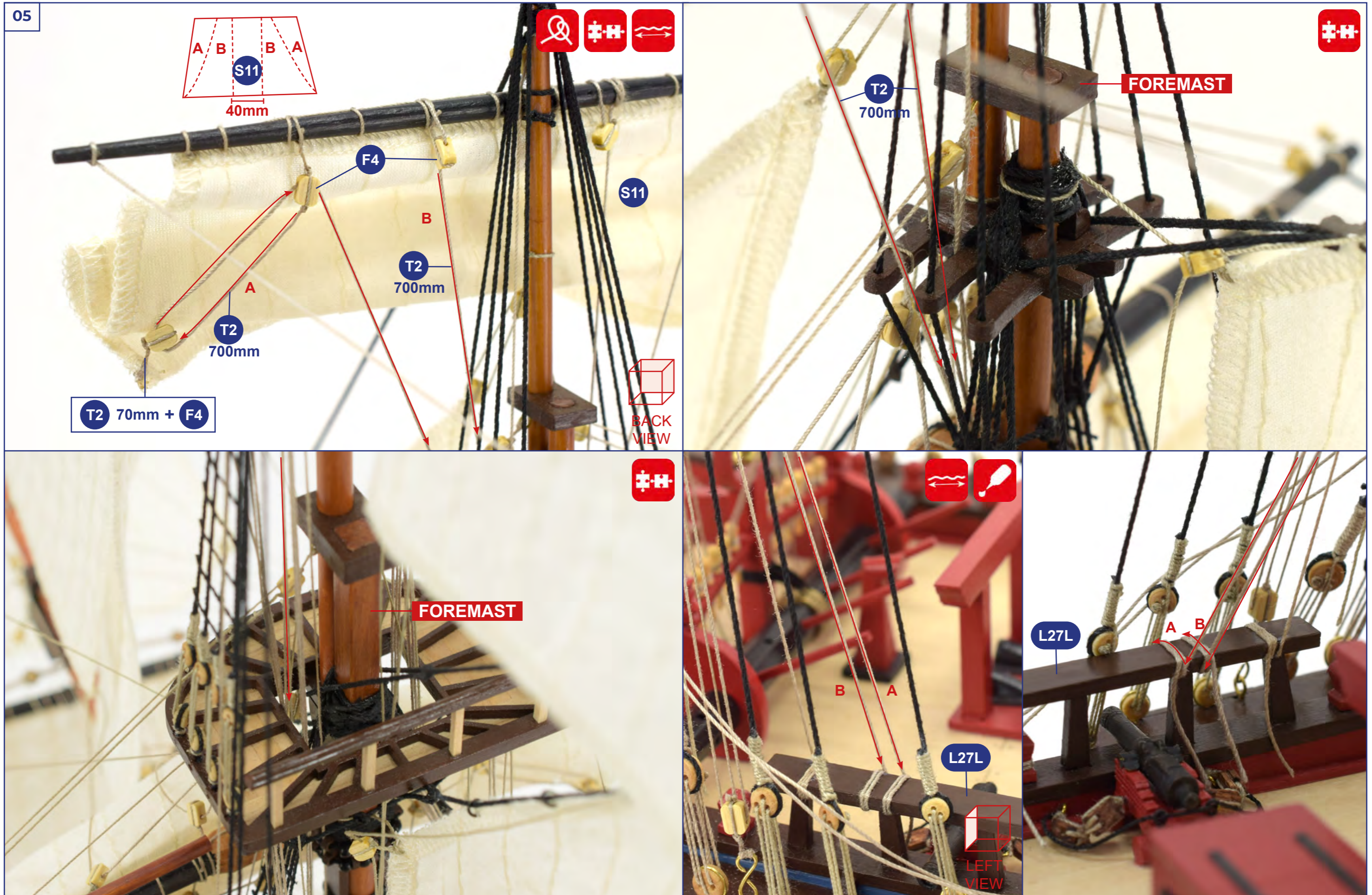

06

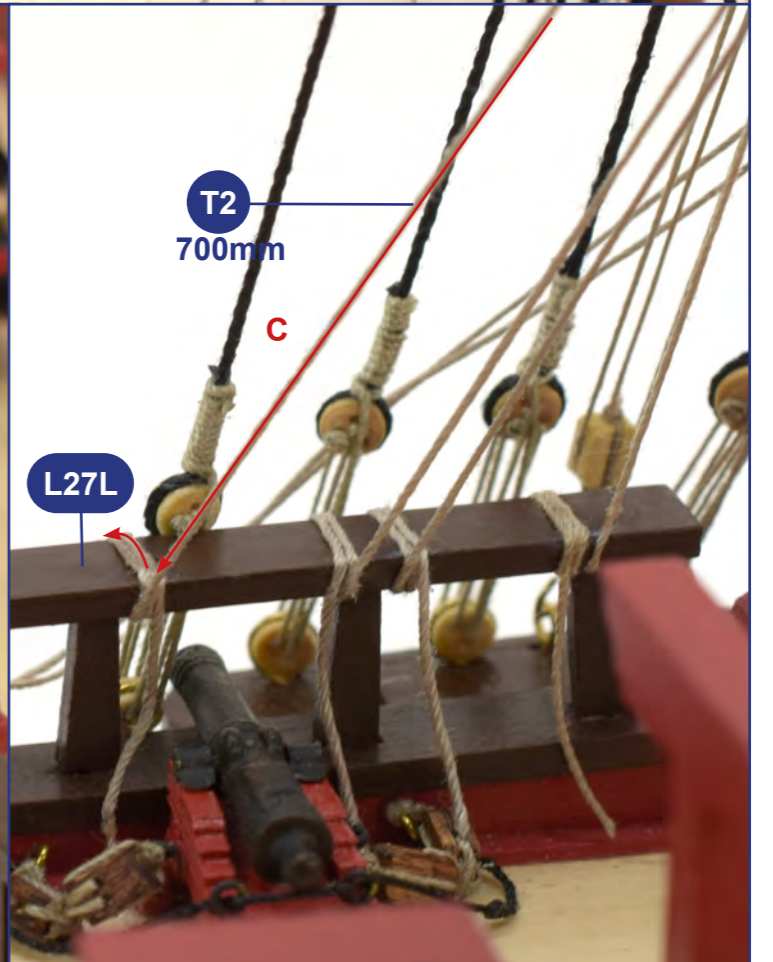
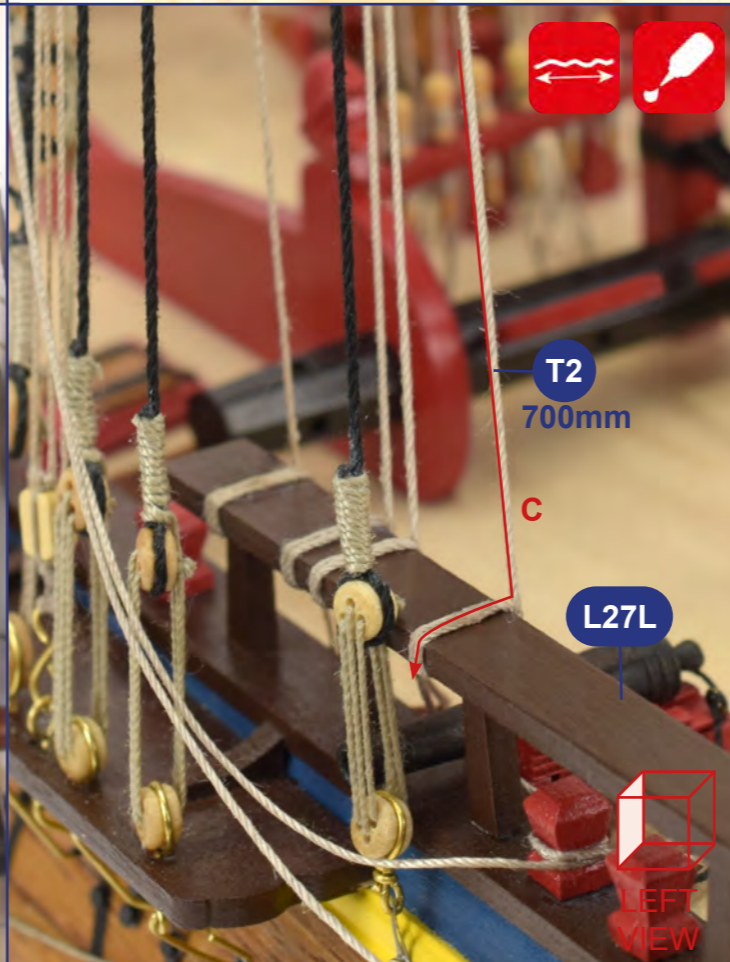
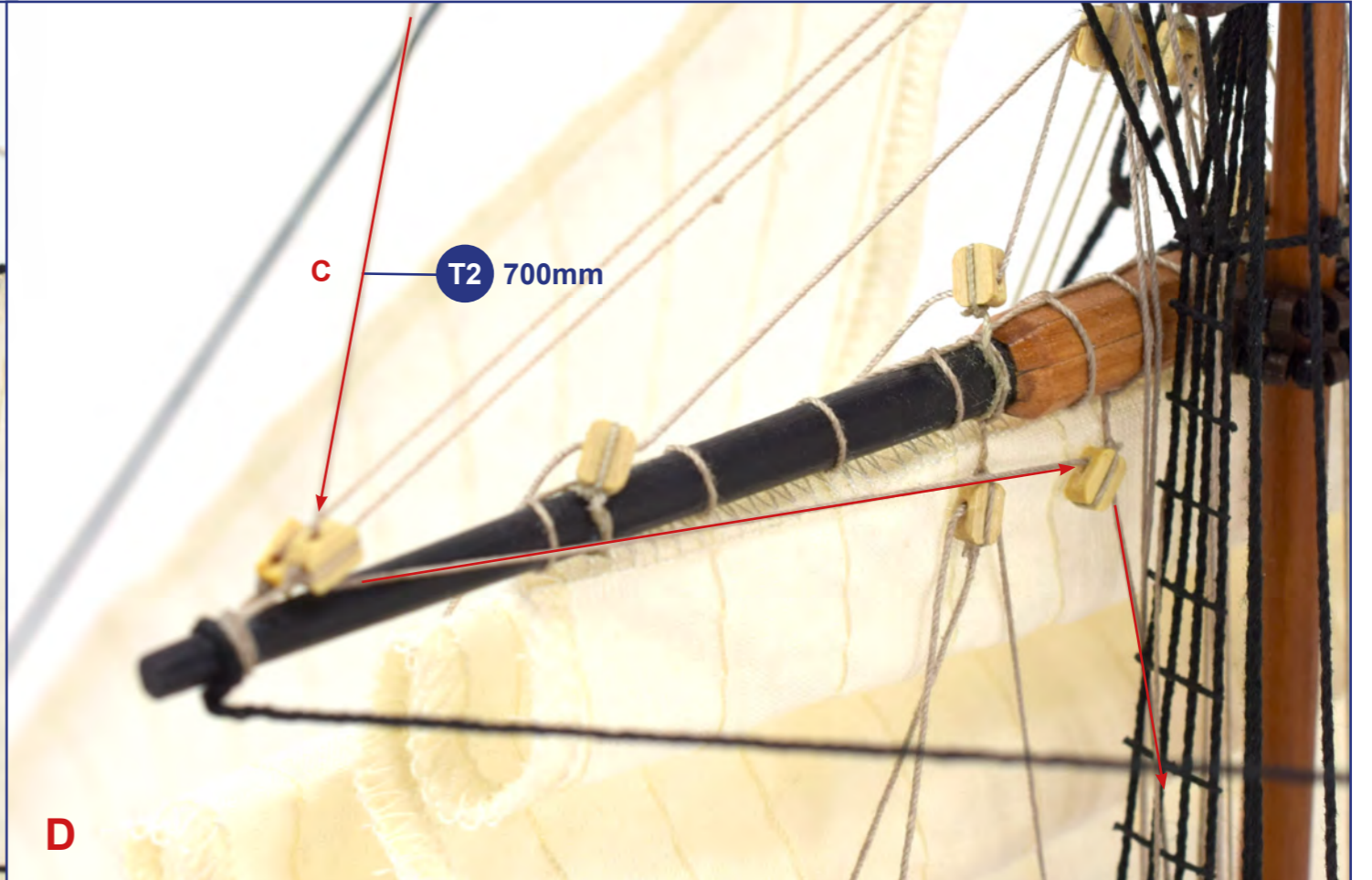
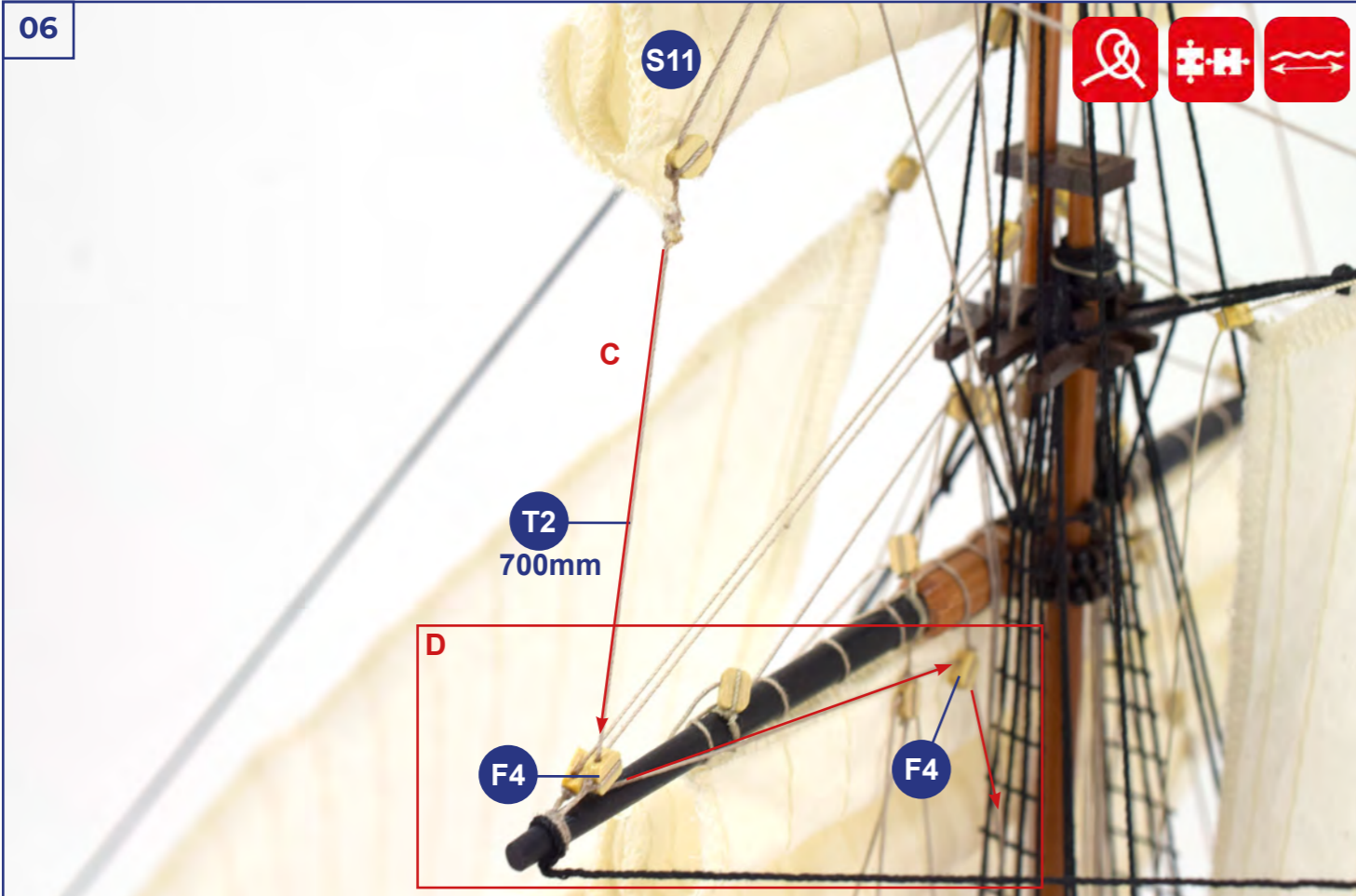

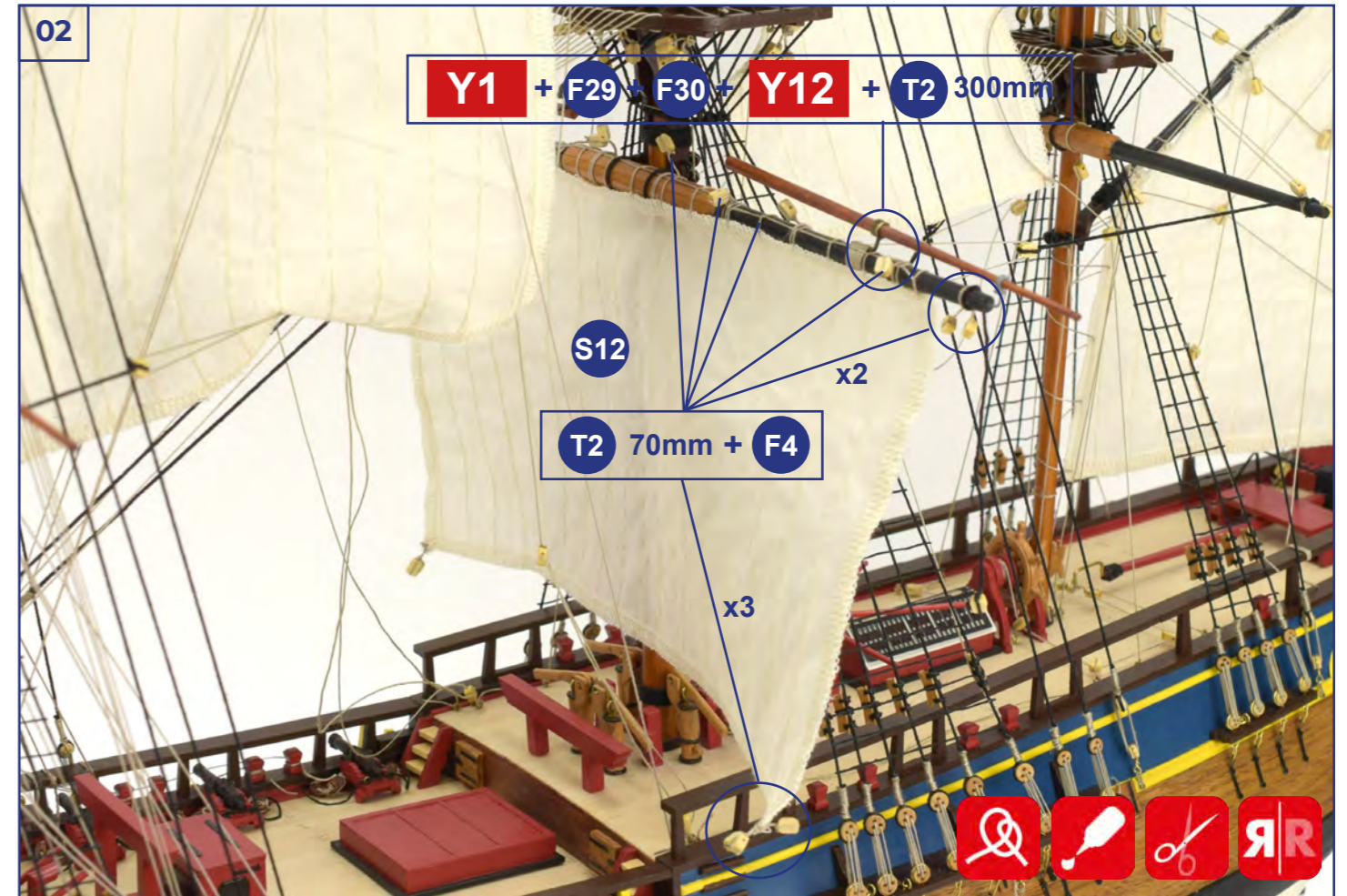
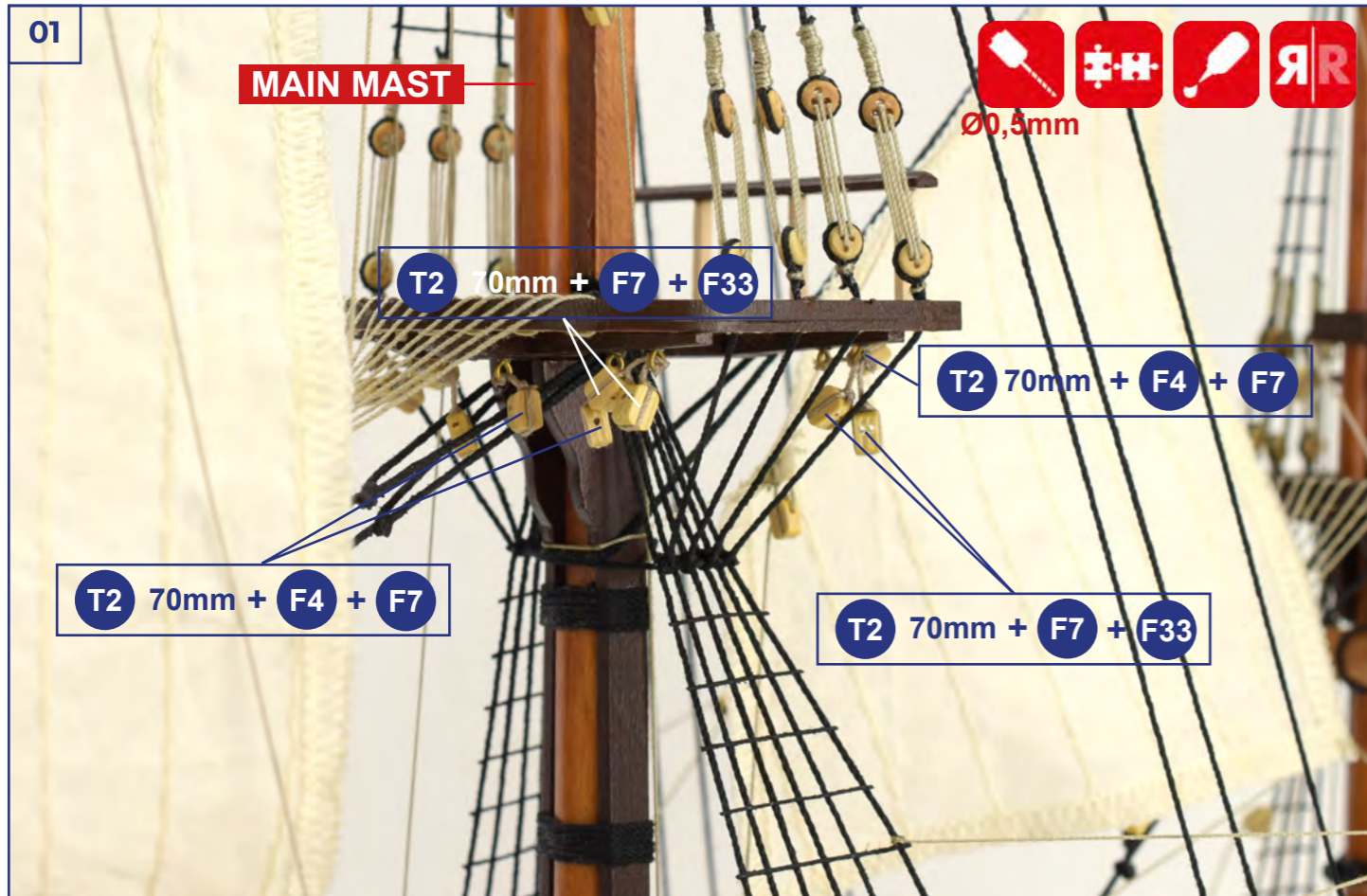

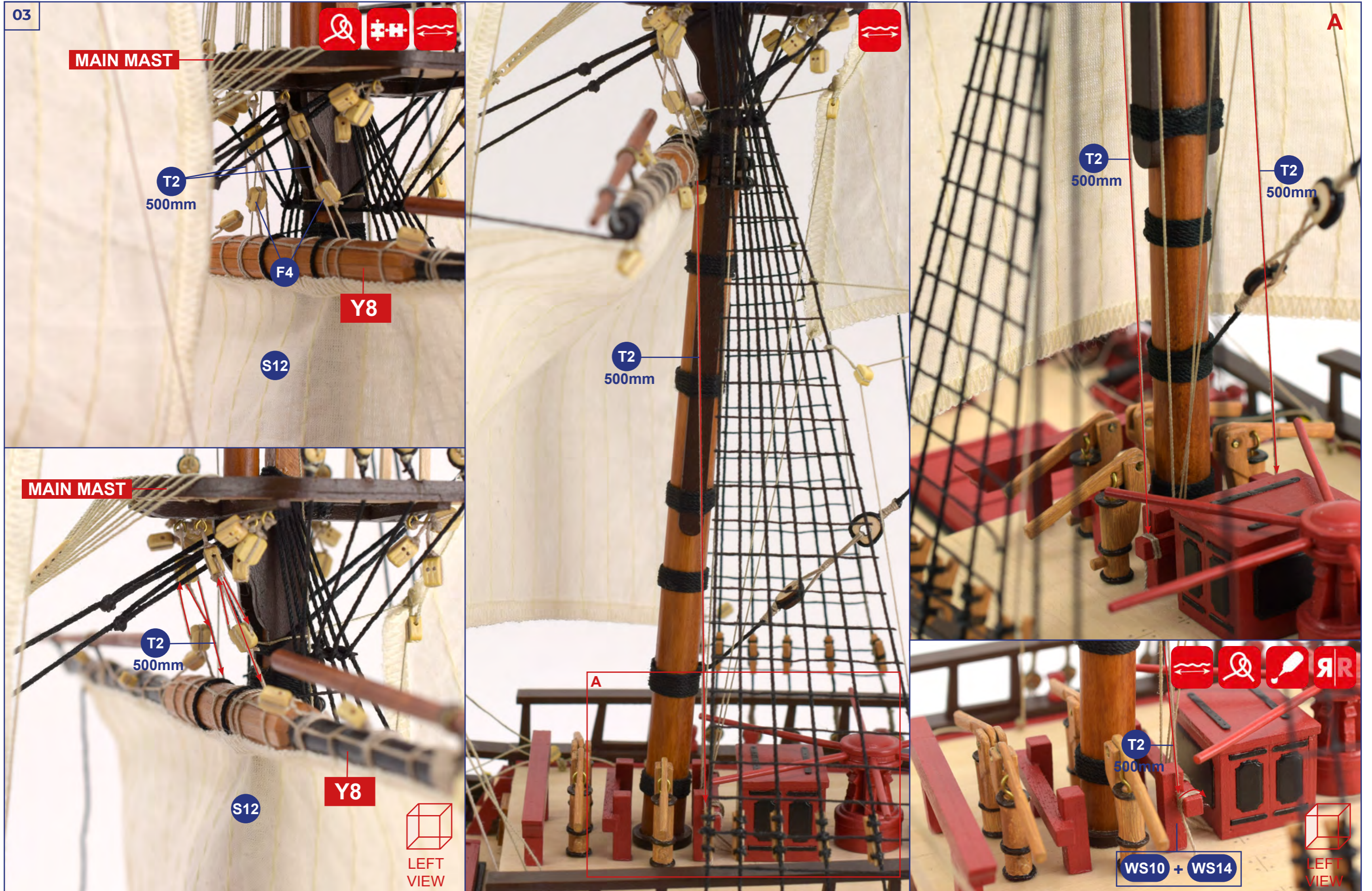

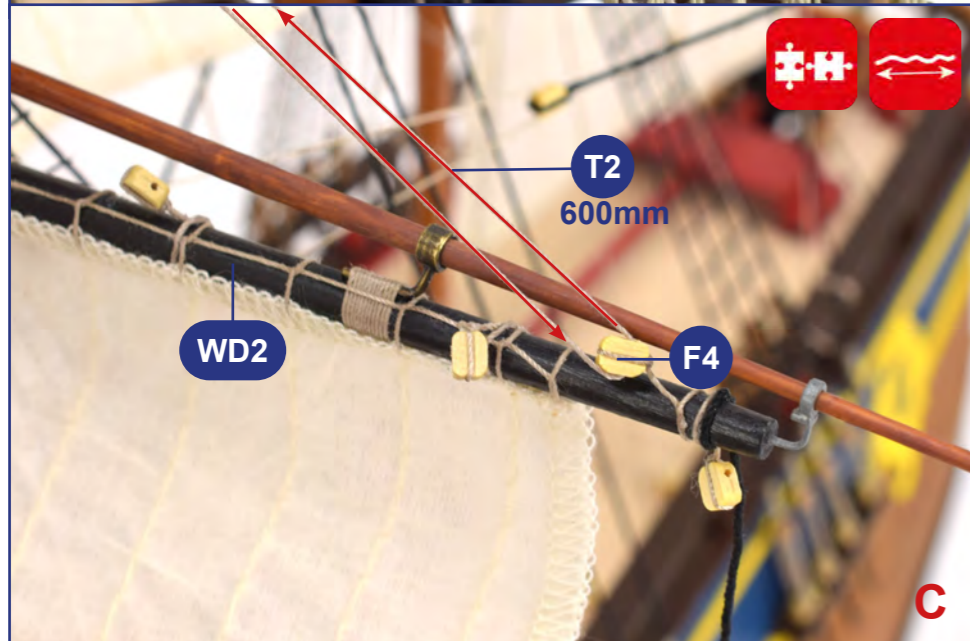
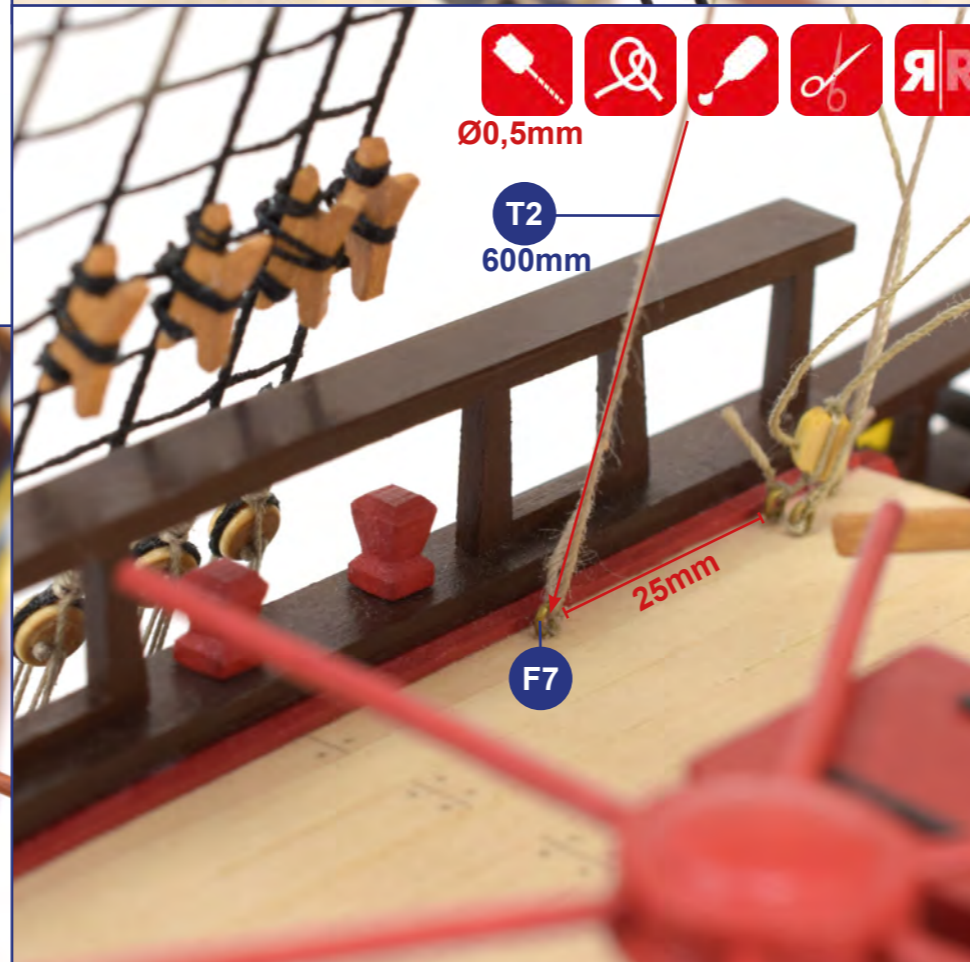
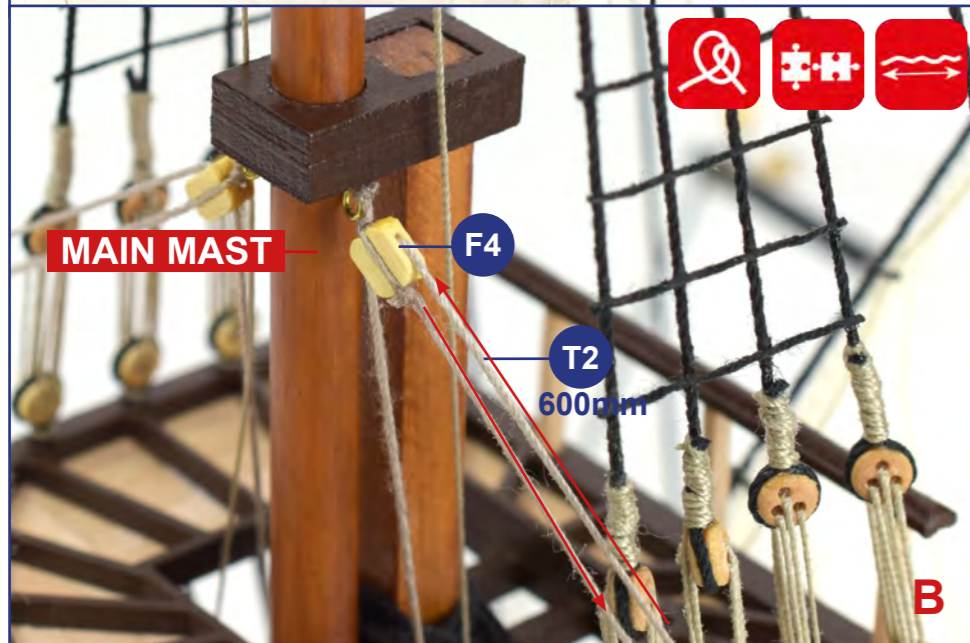
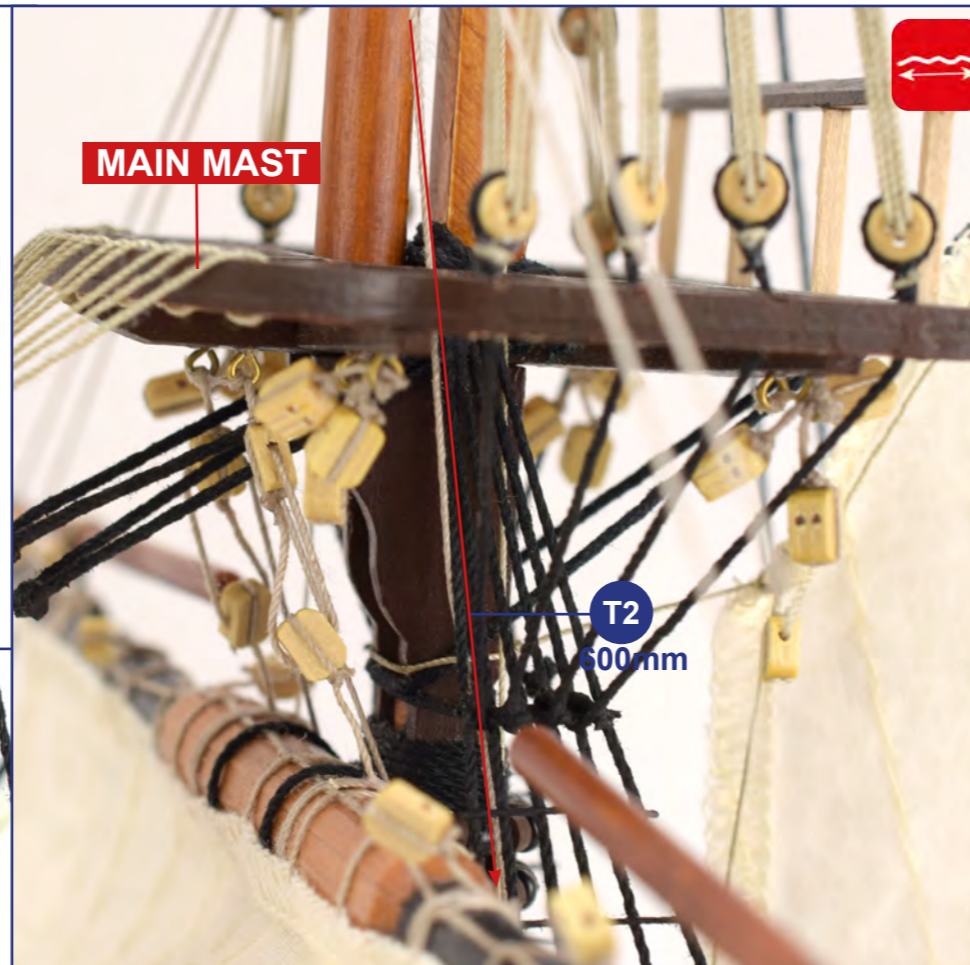
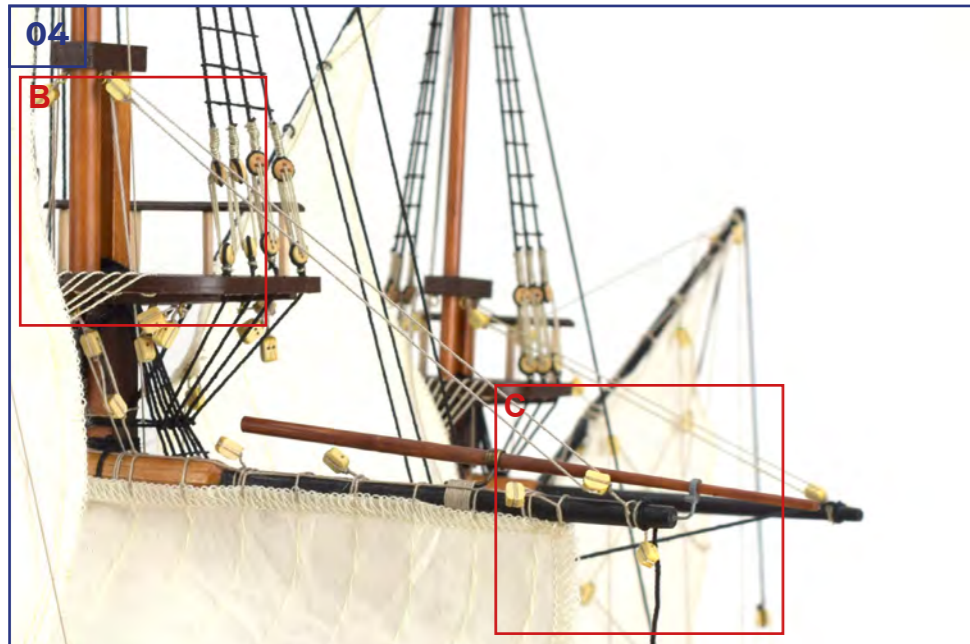

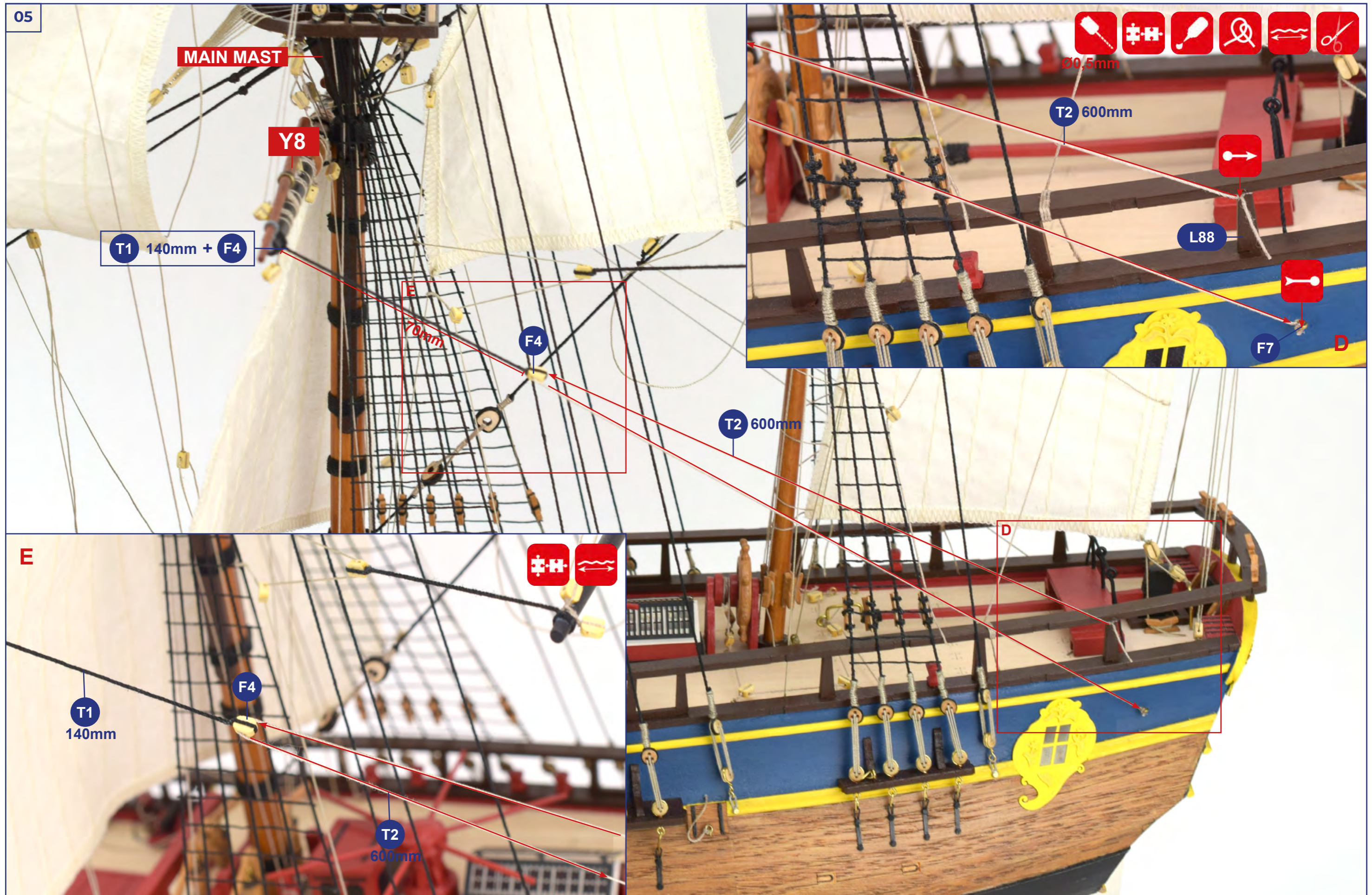

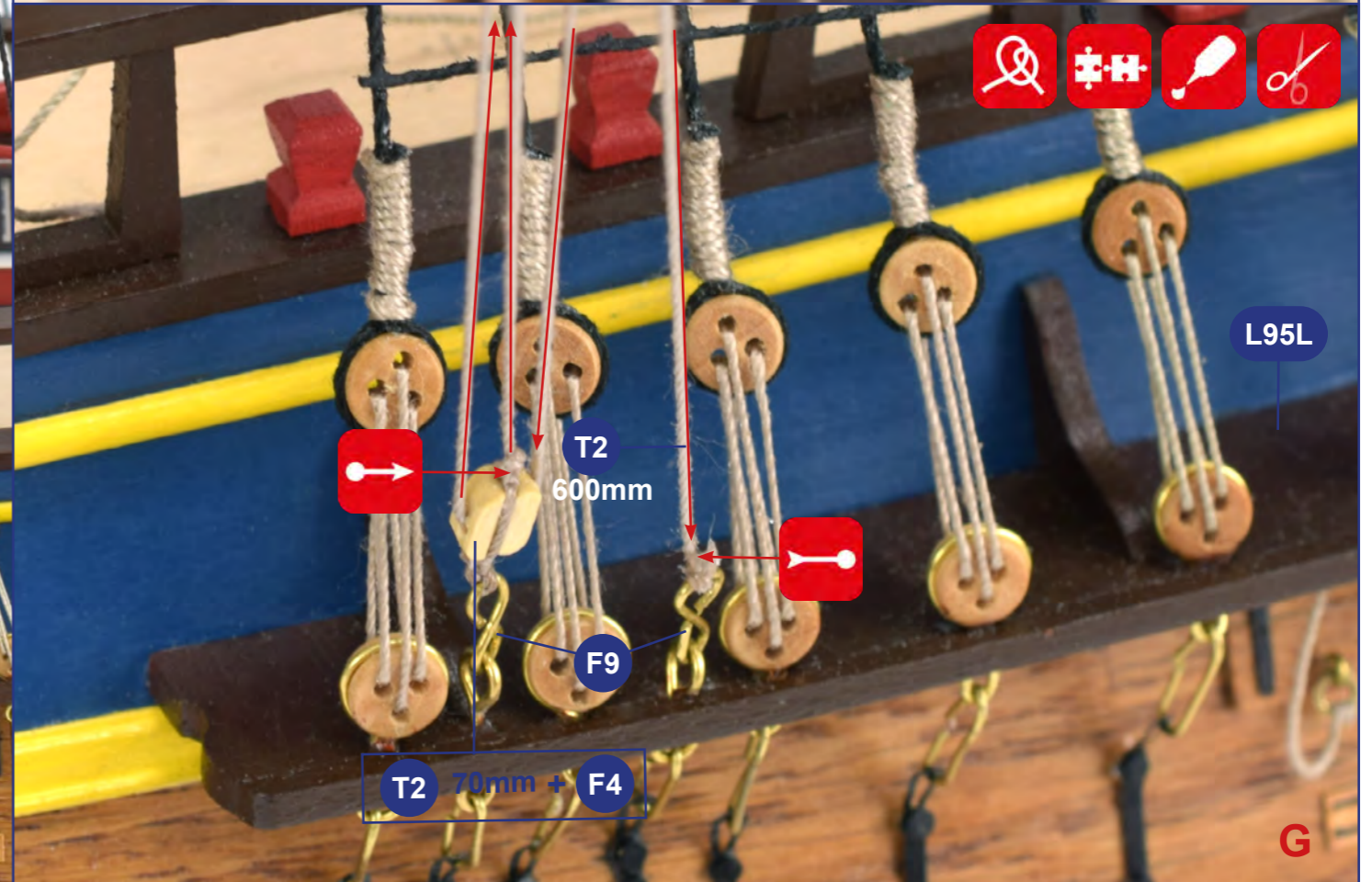
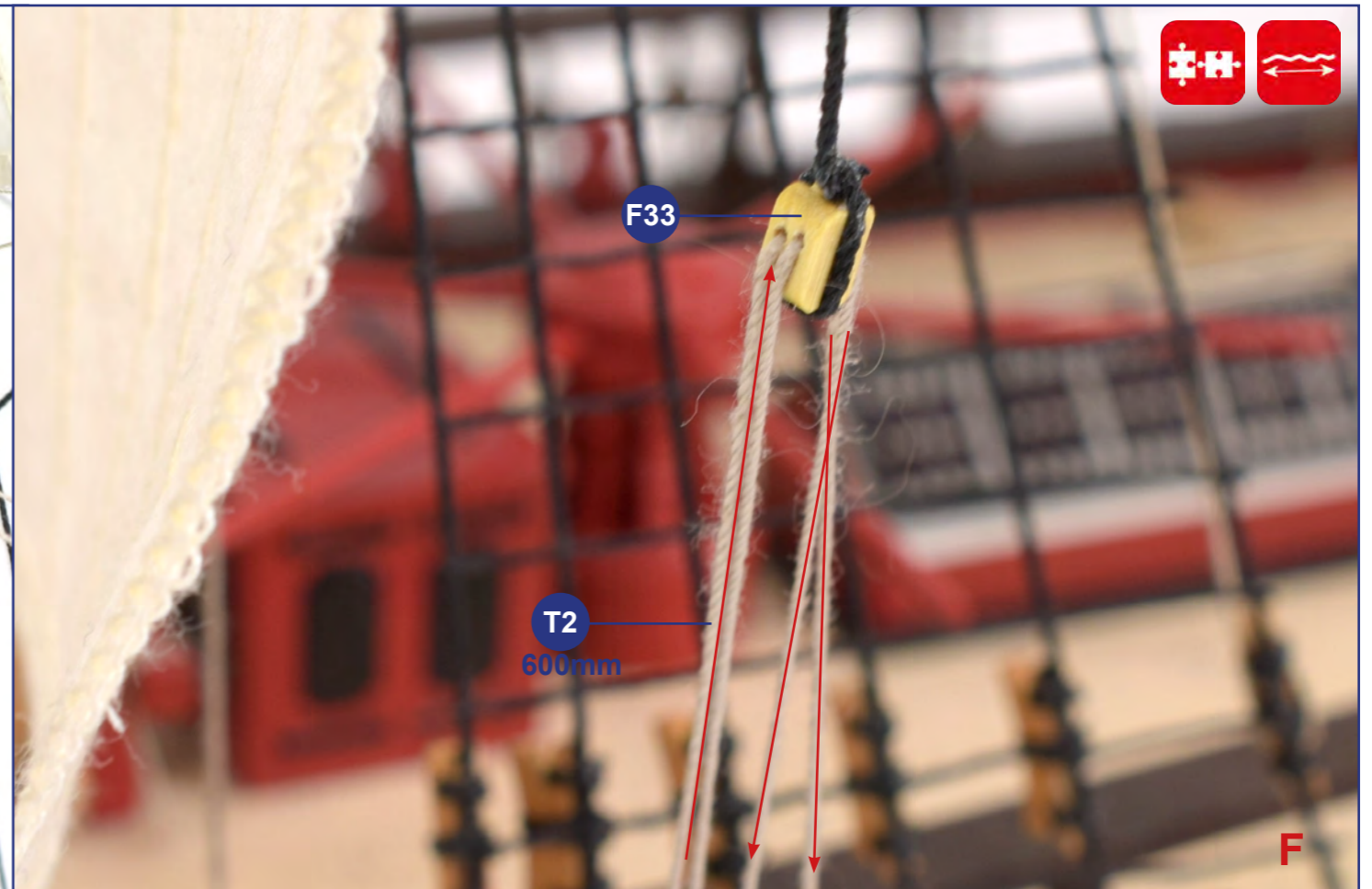

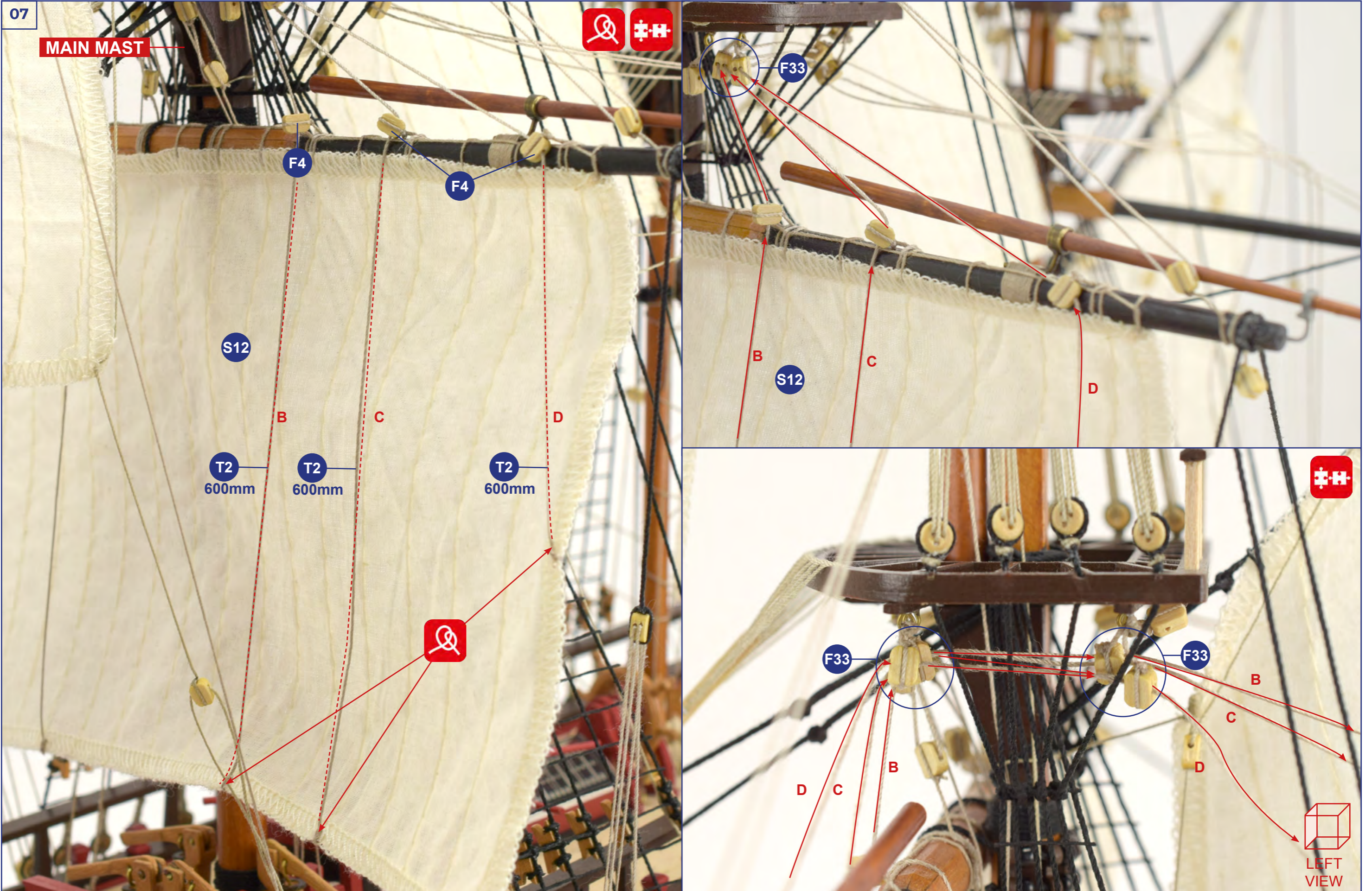

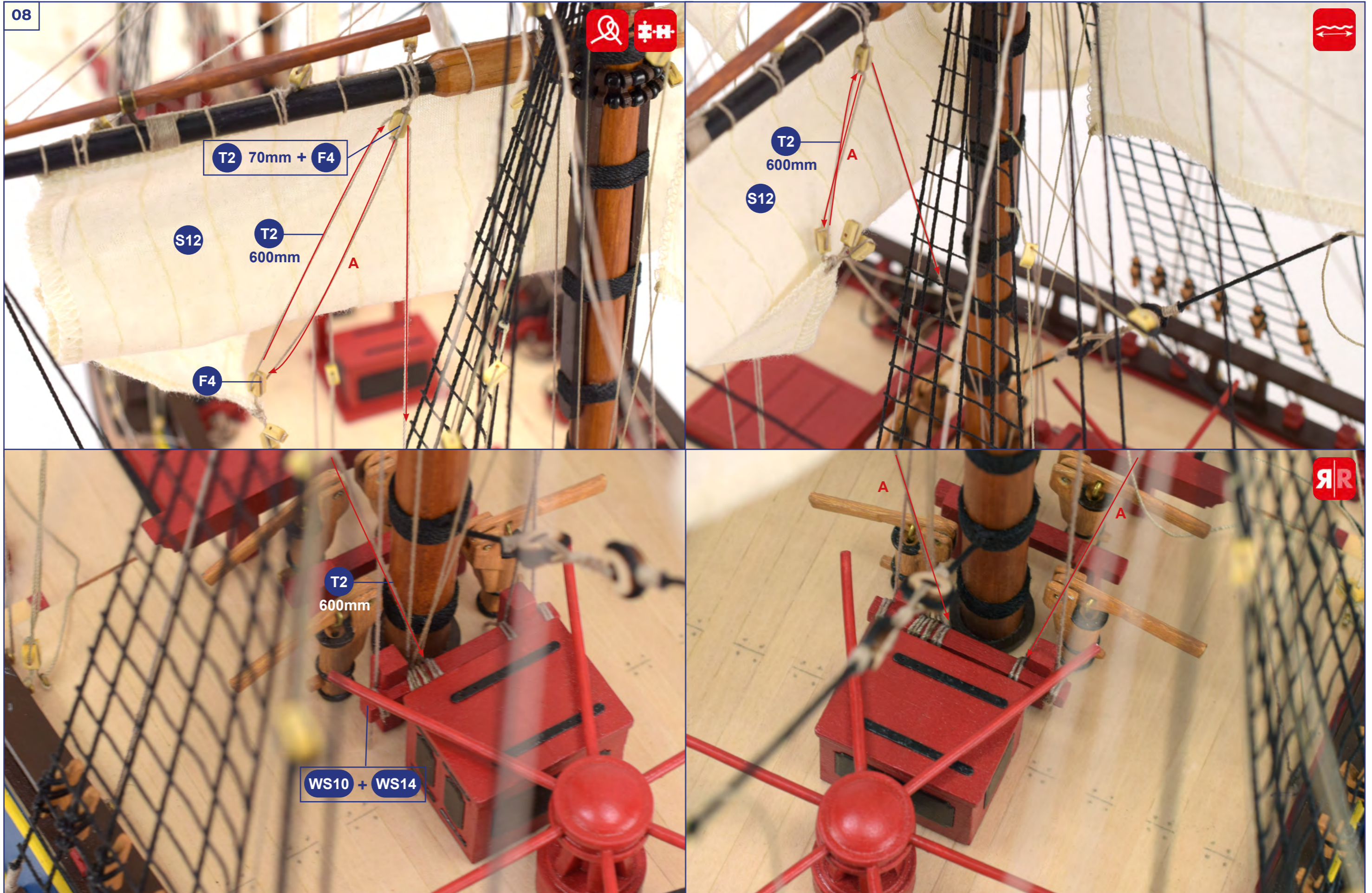

09

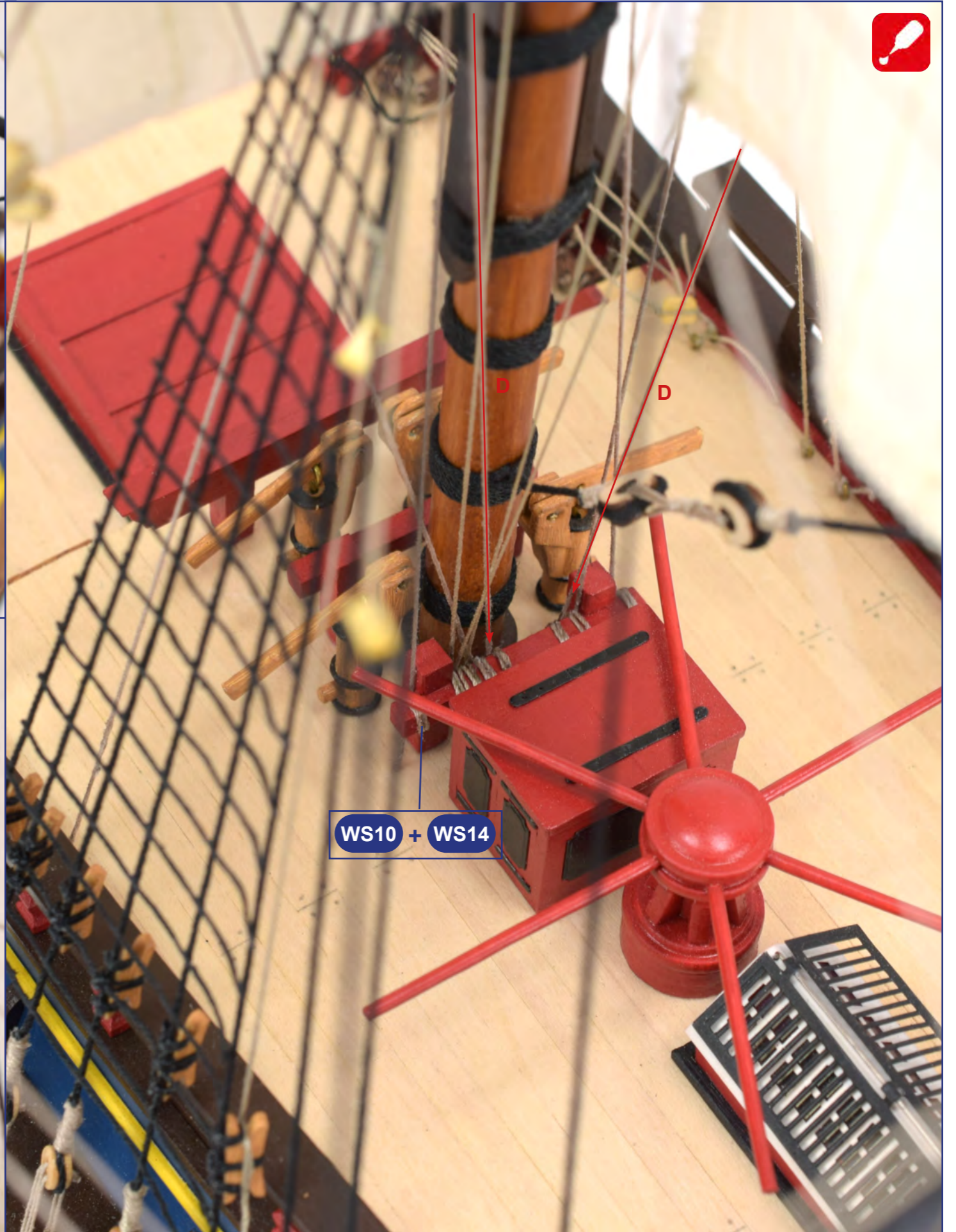
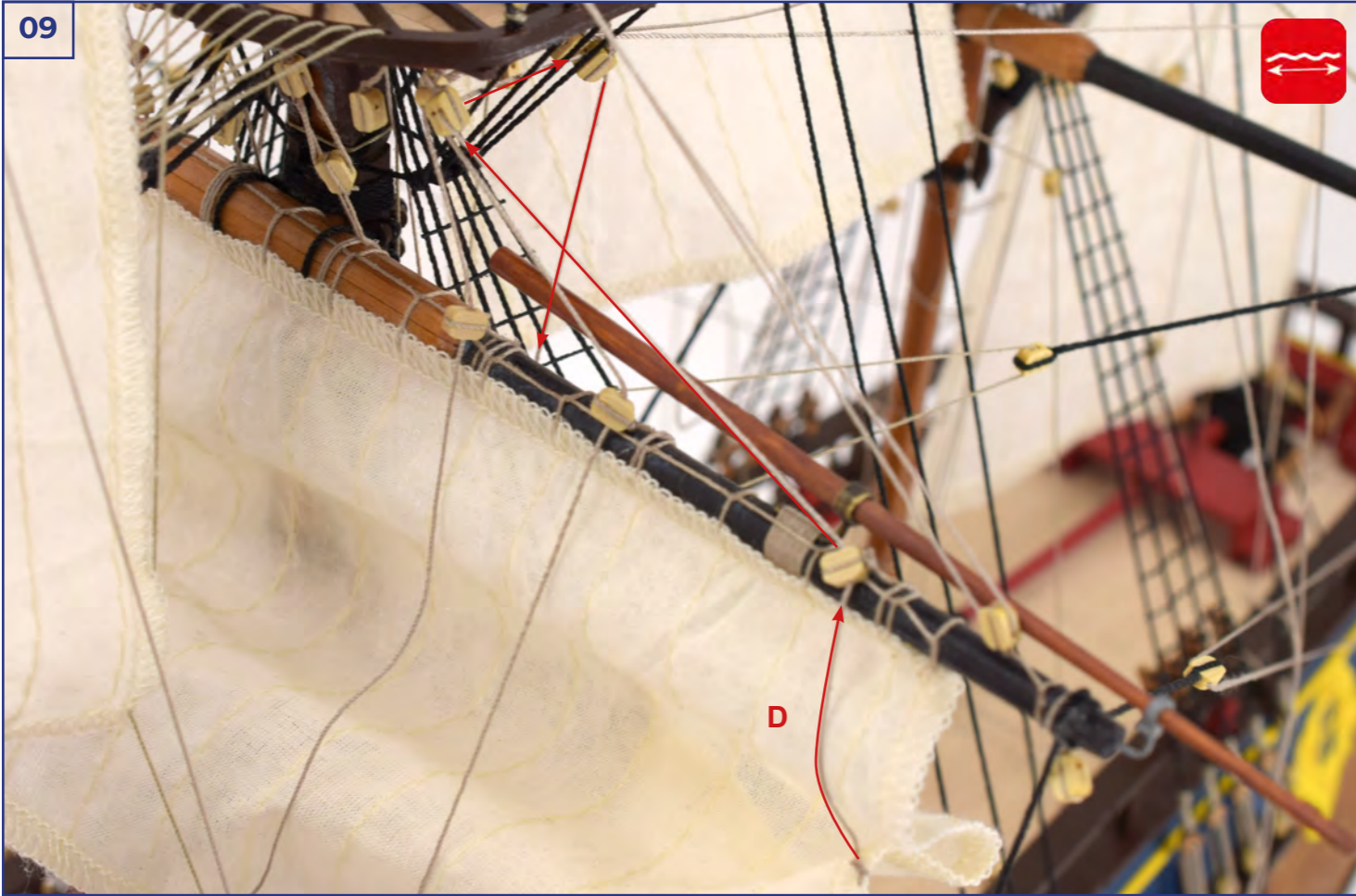

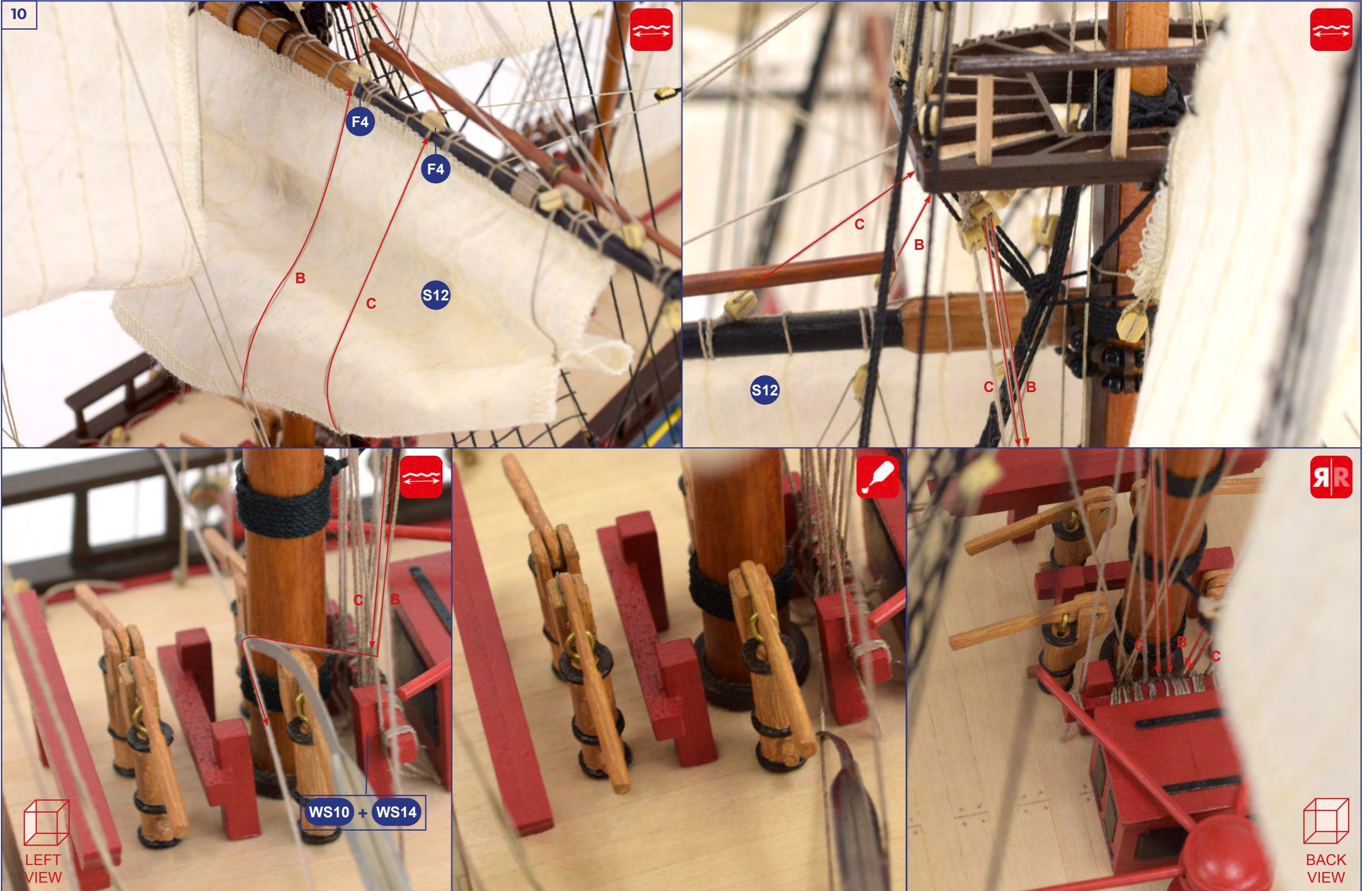

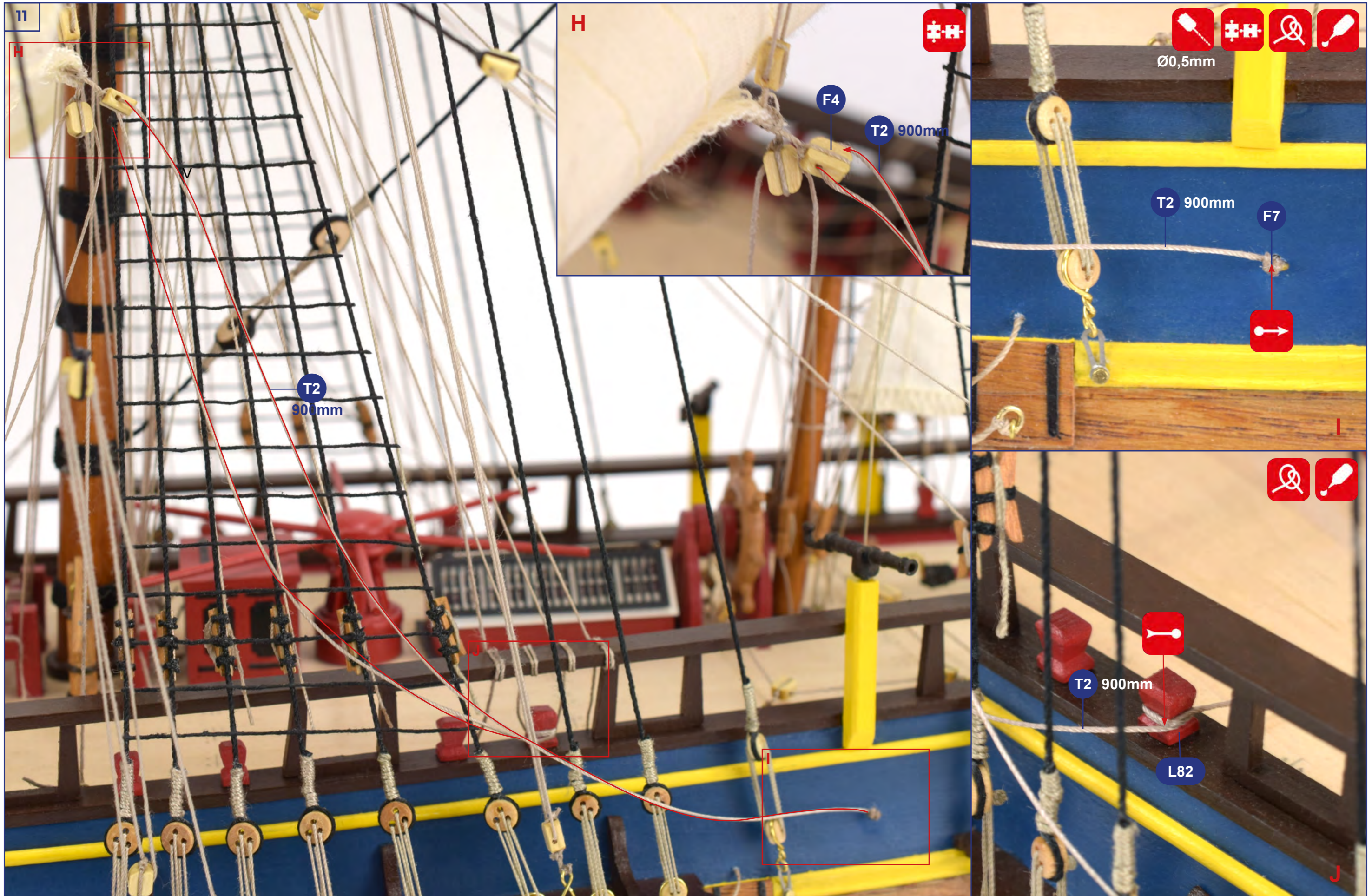

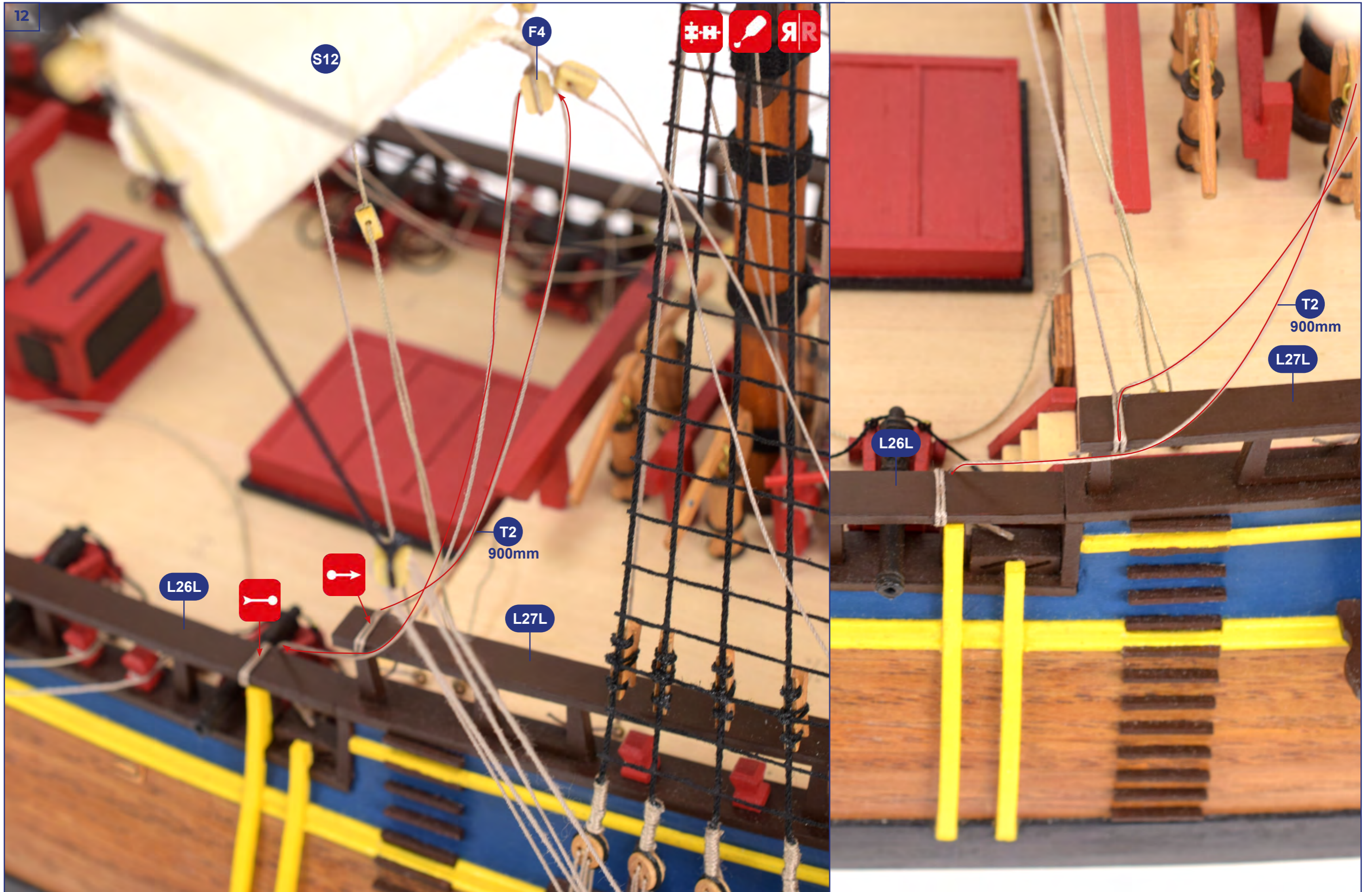

13



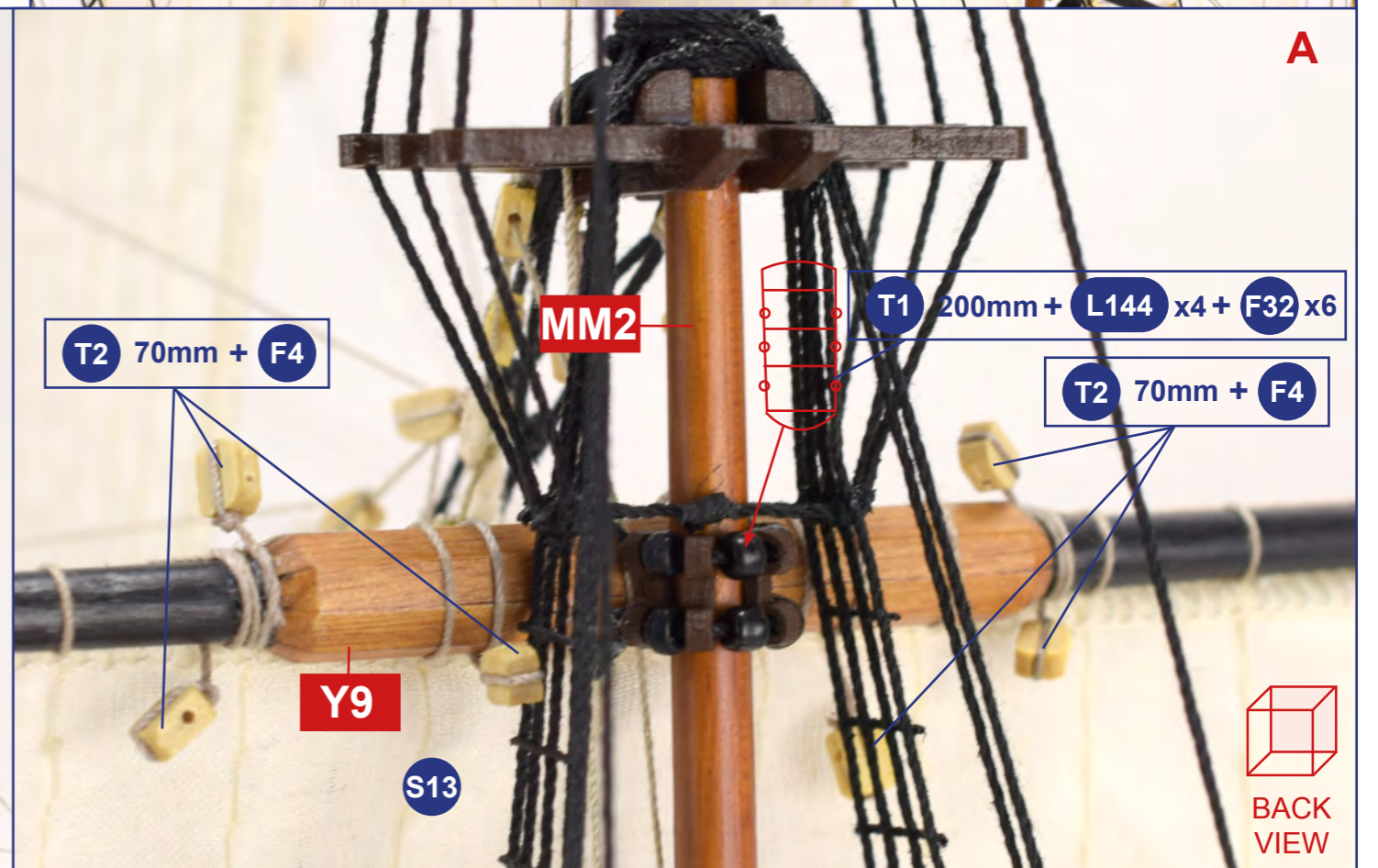
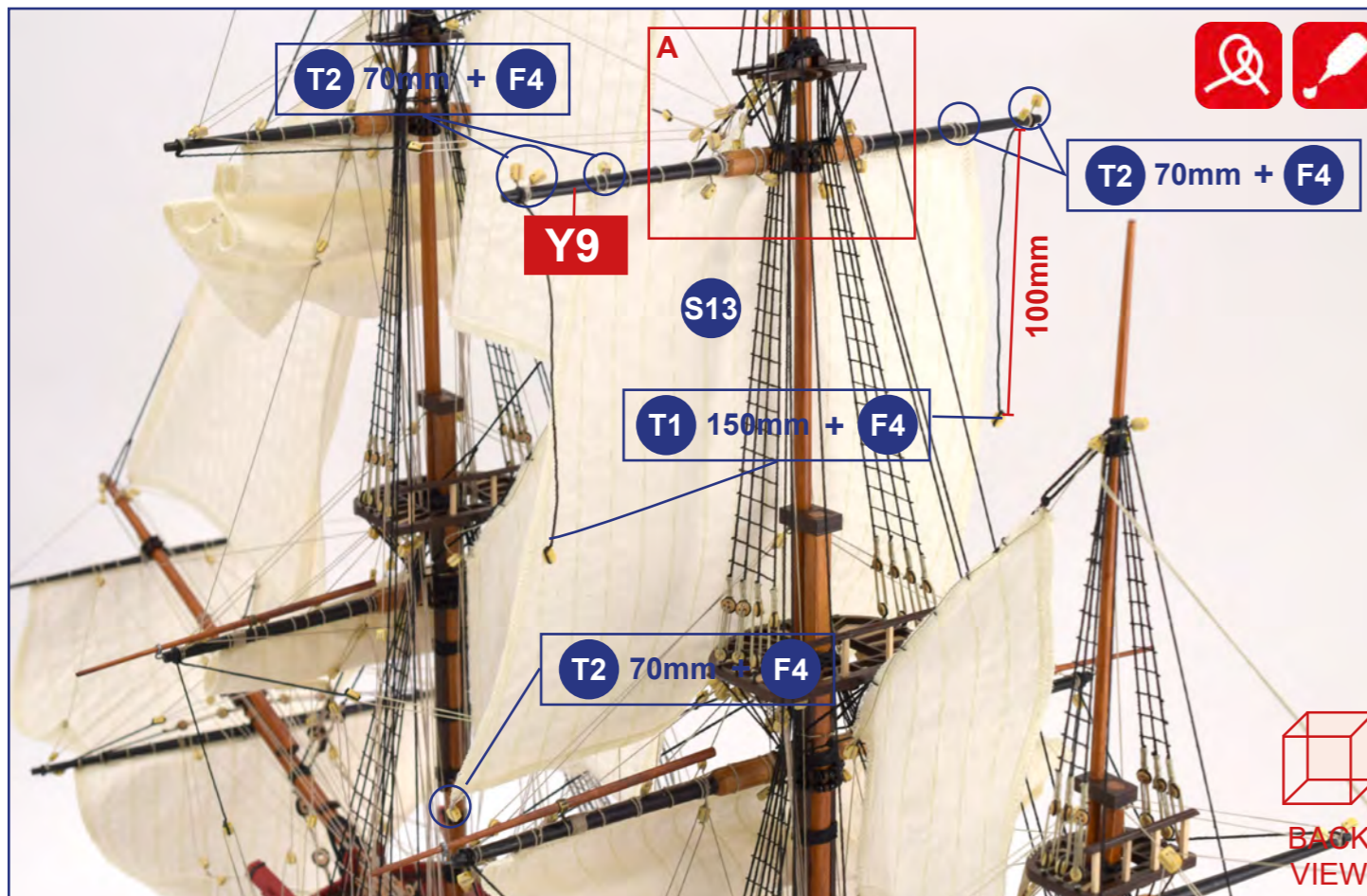

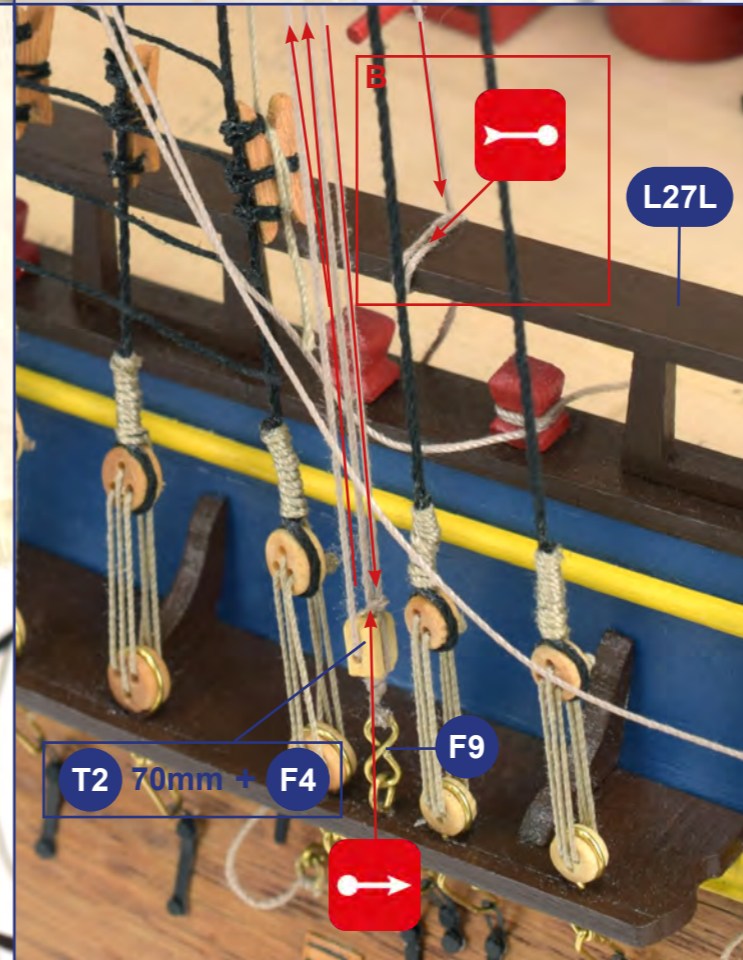
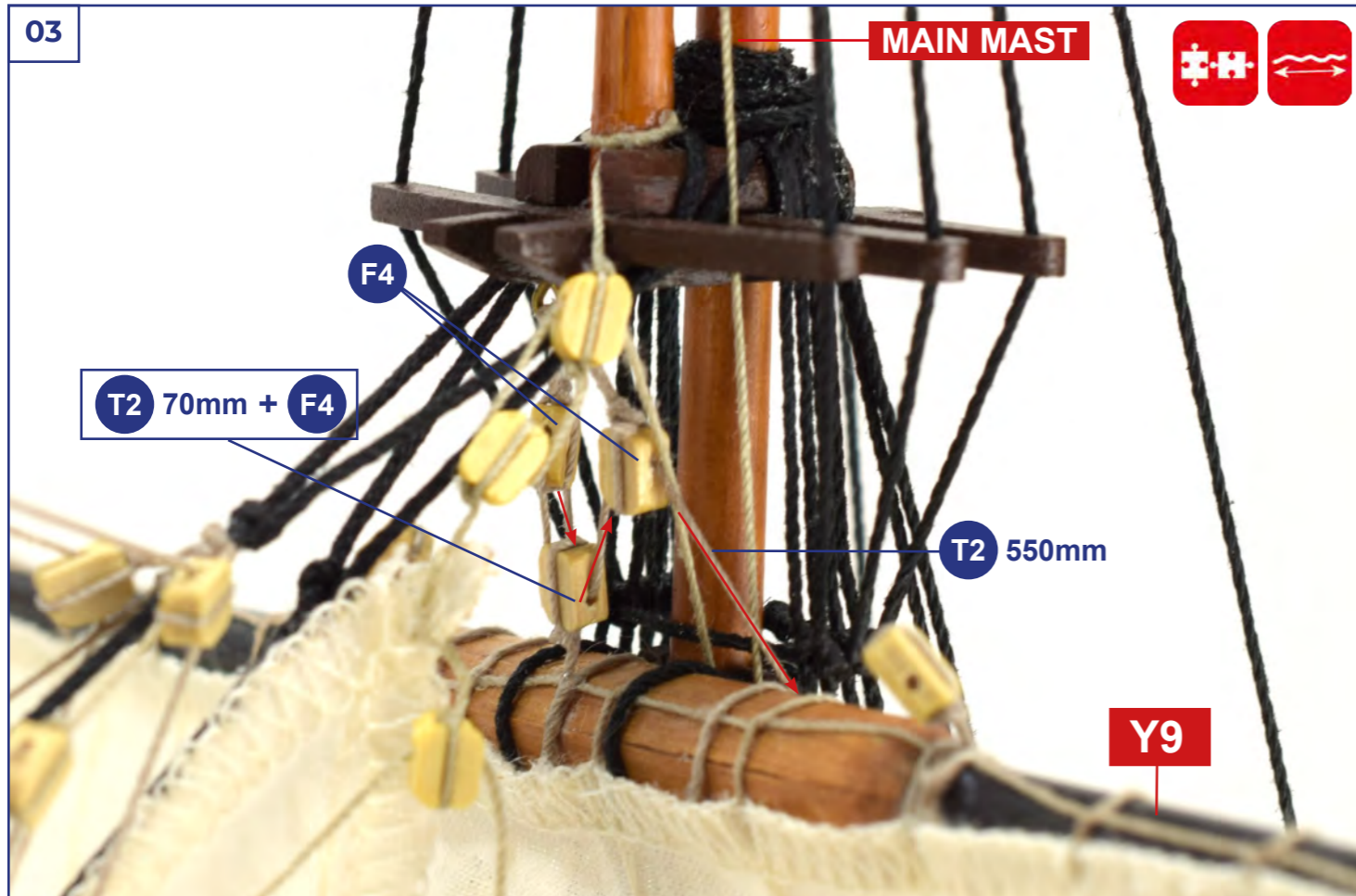

04

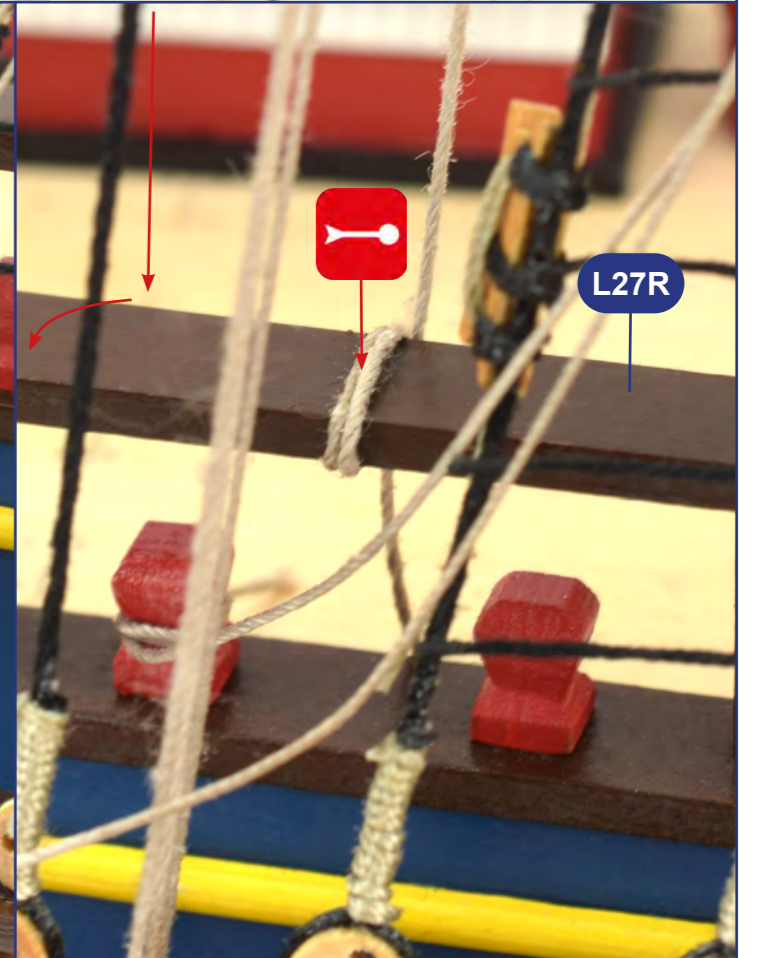
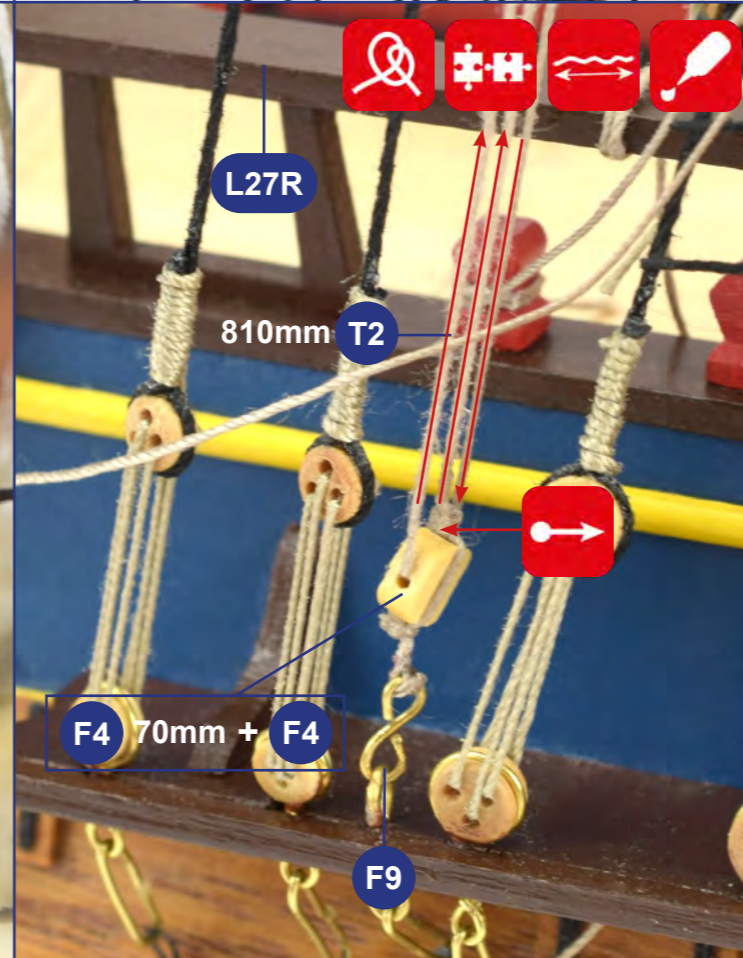
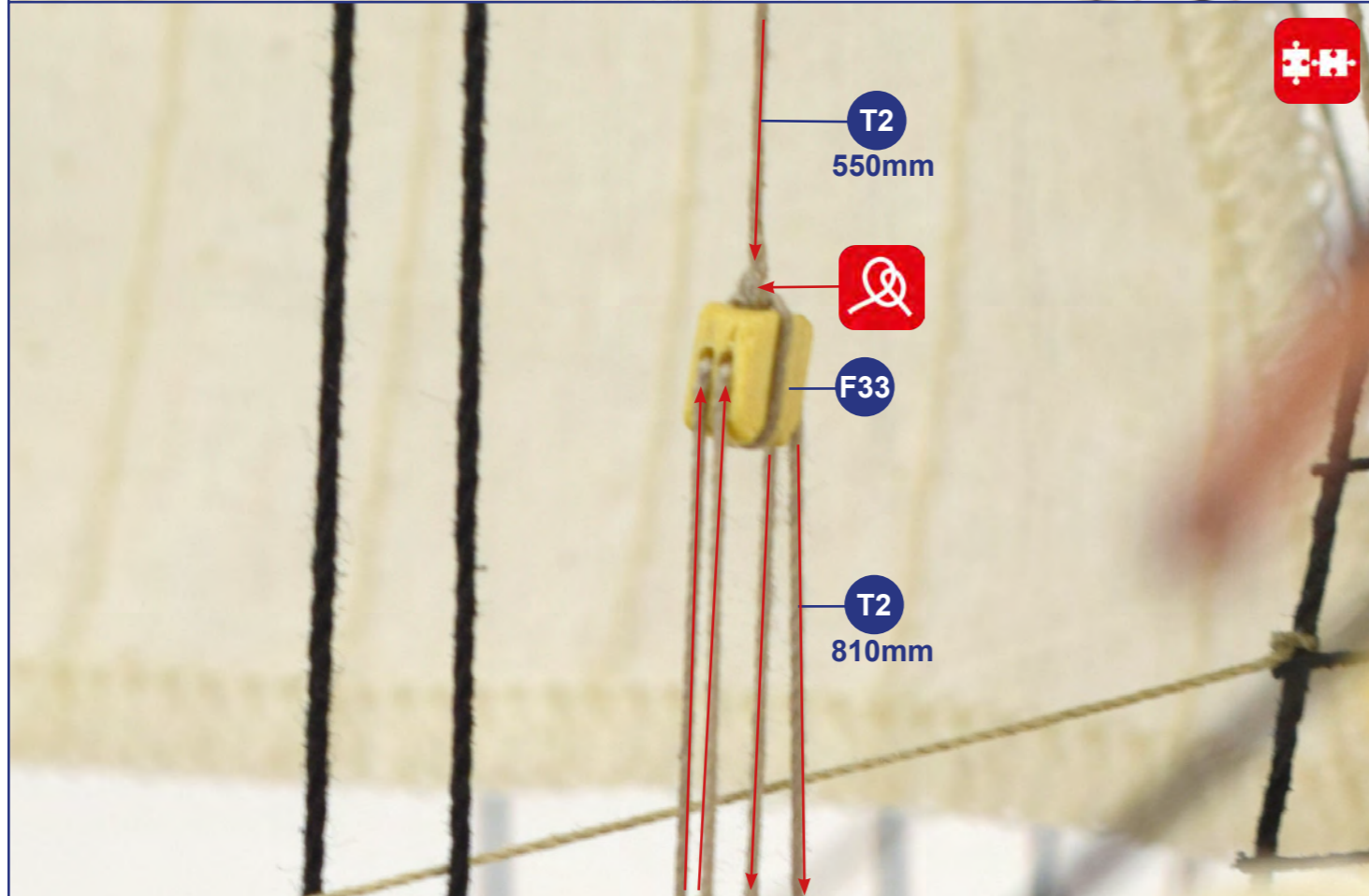

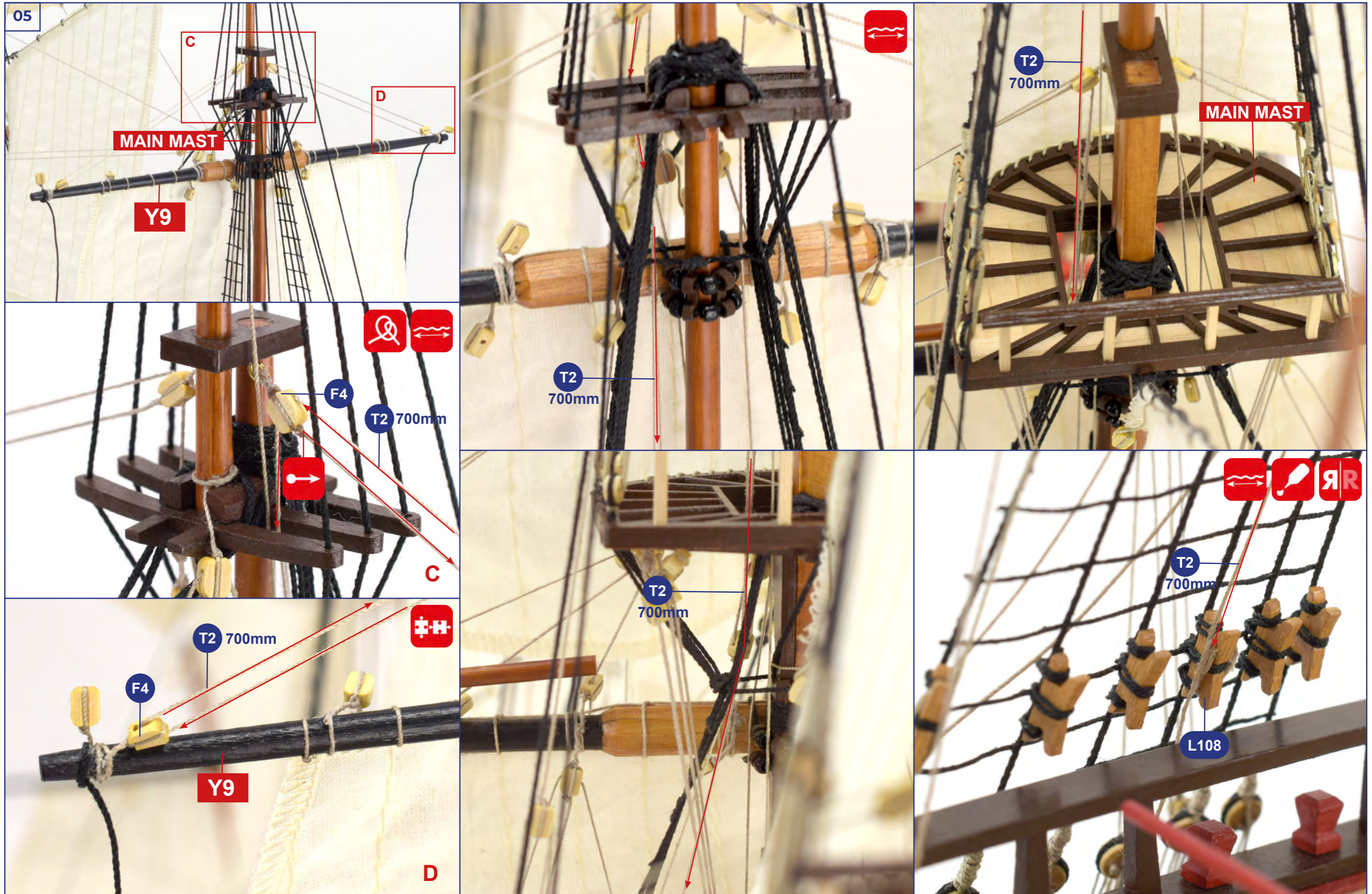

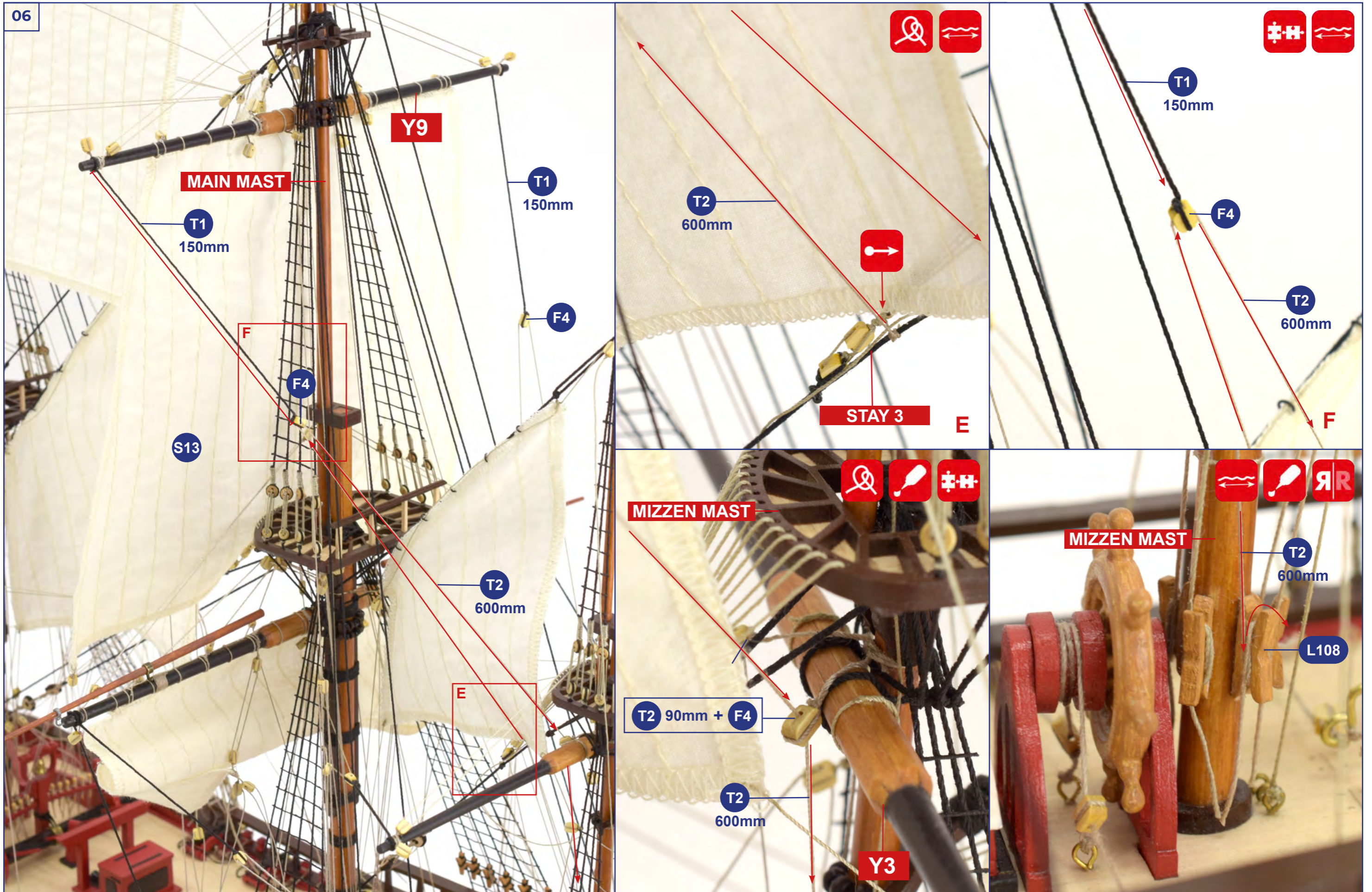

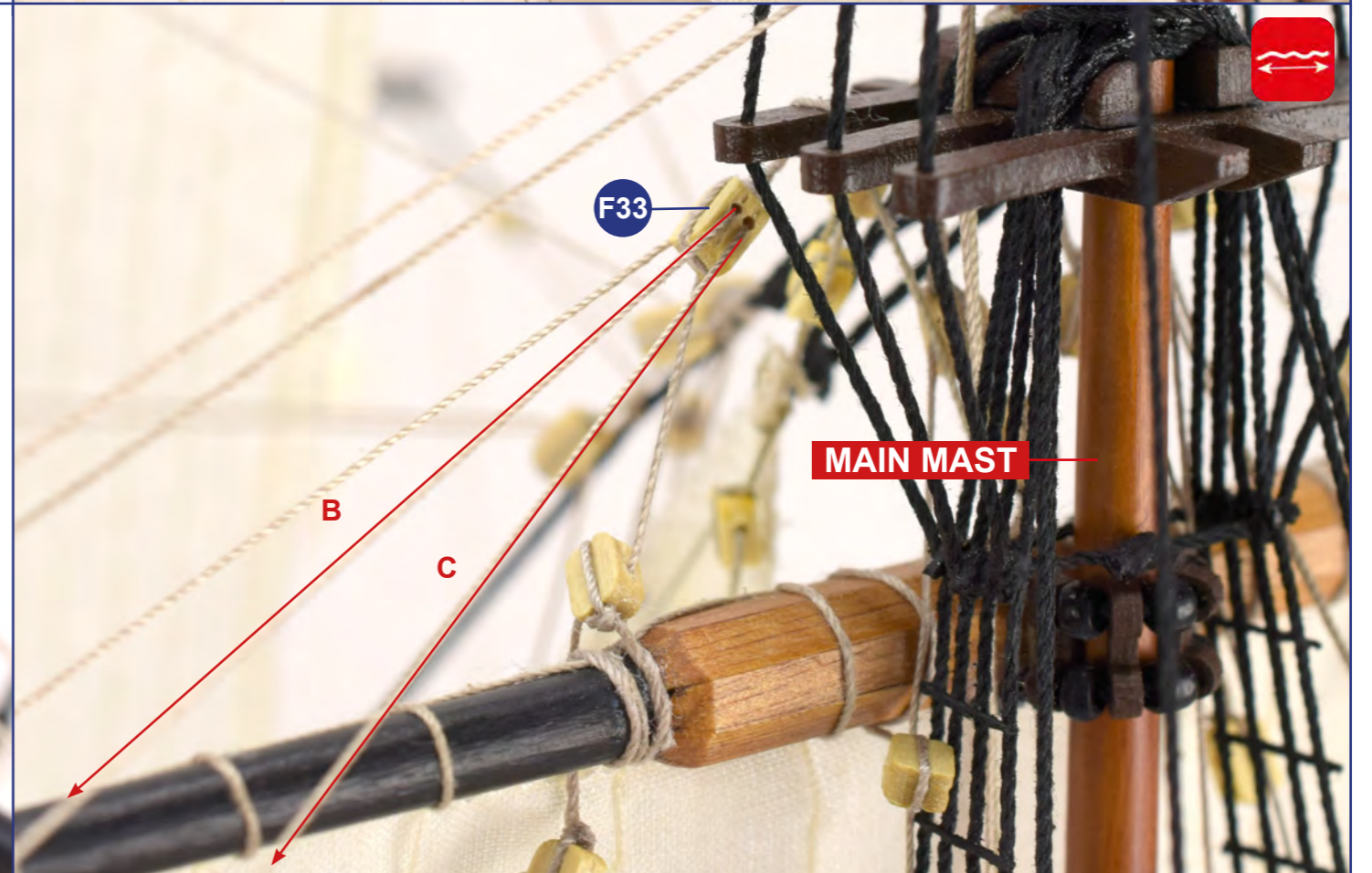
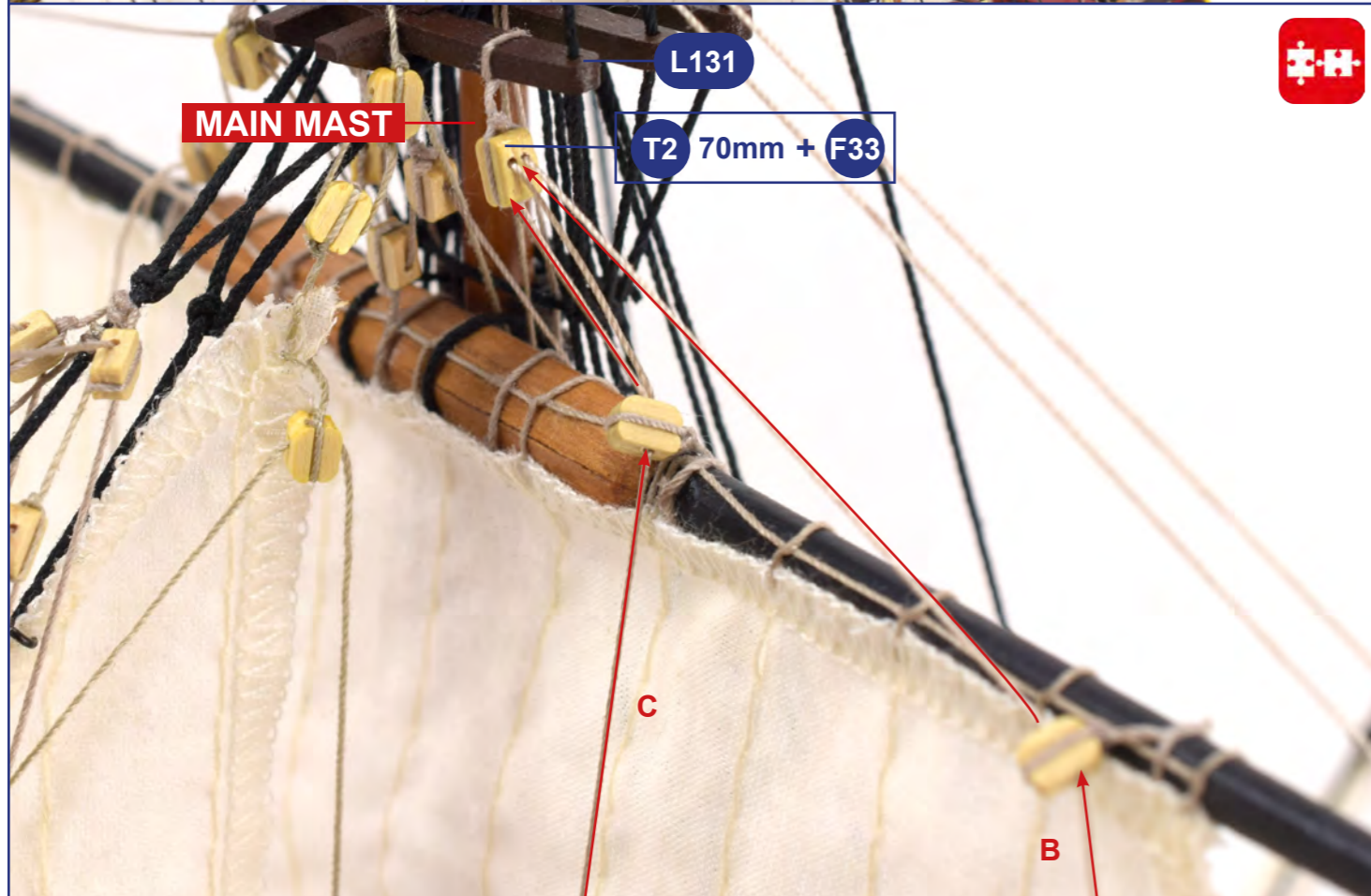
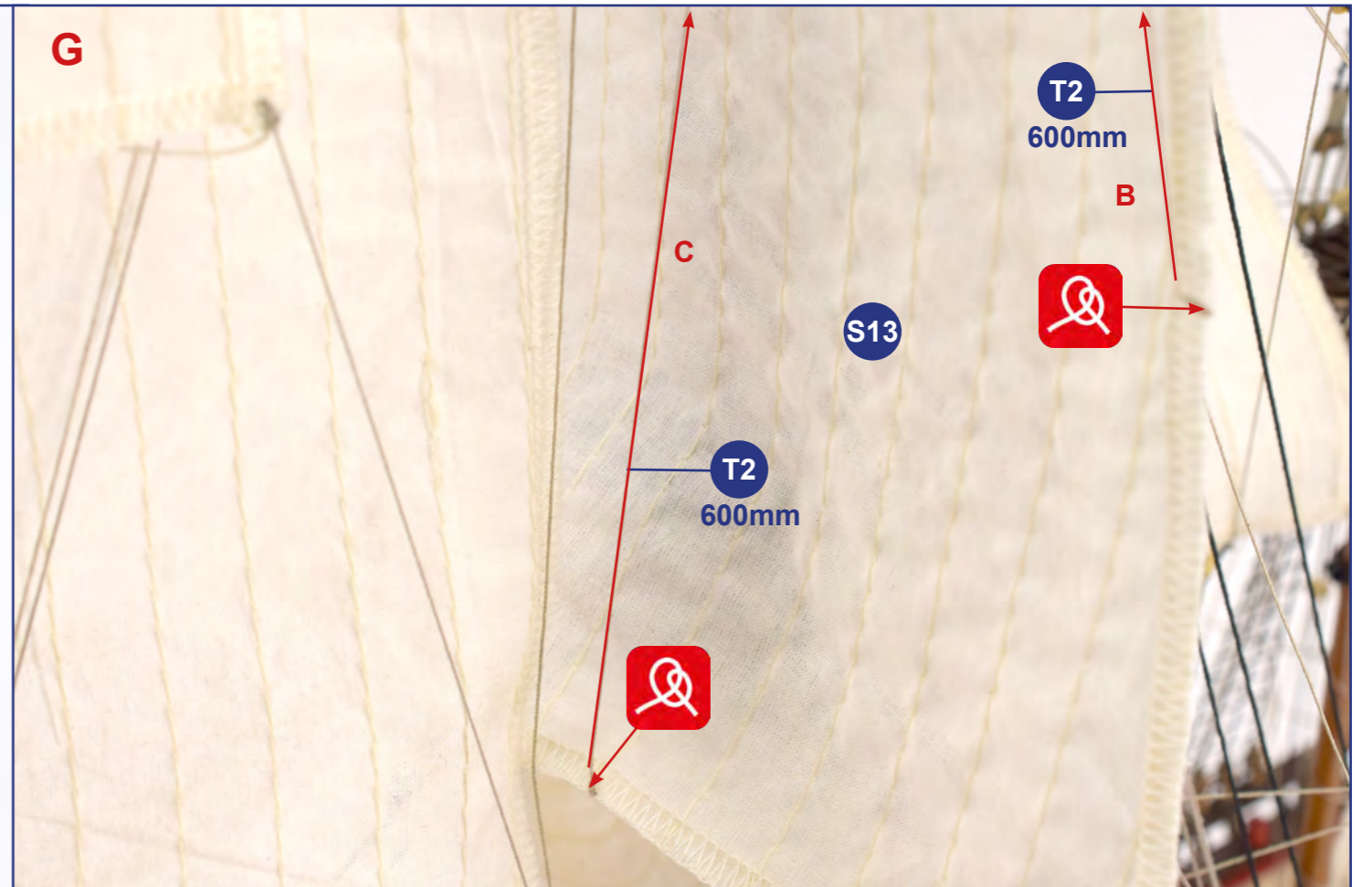
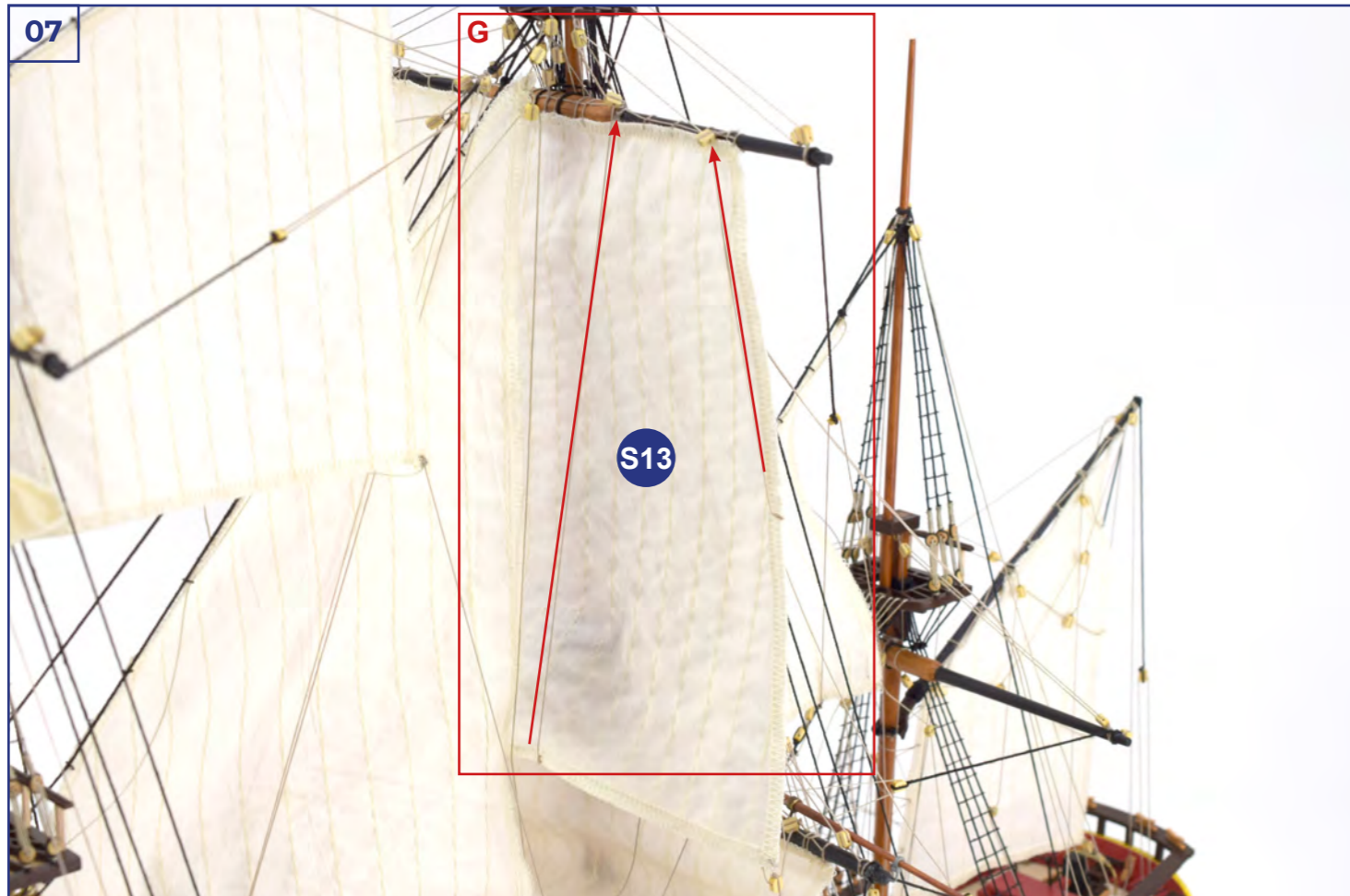

08

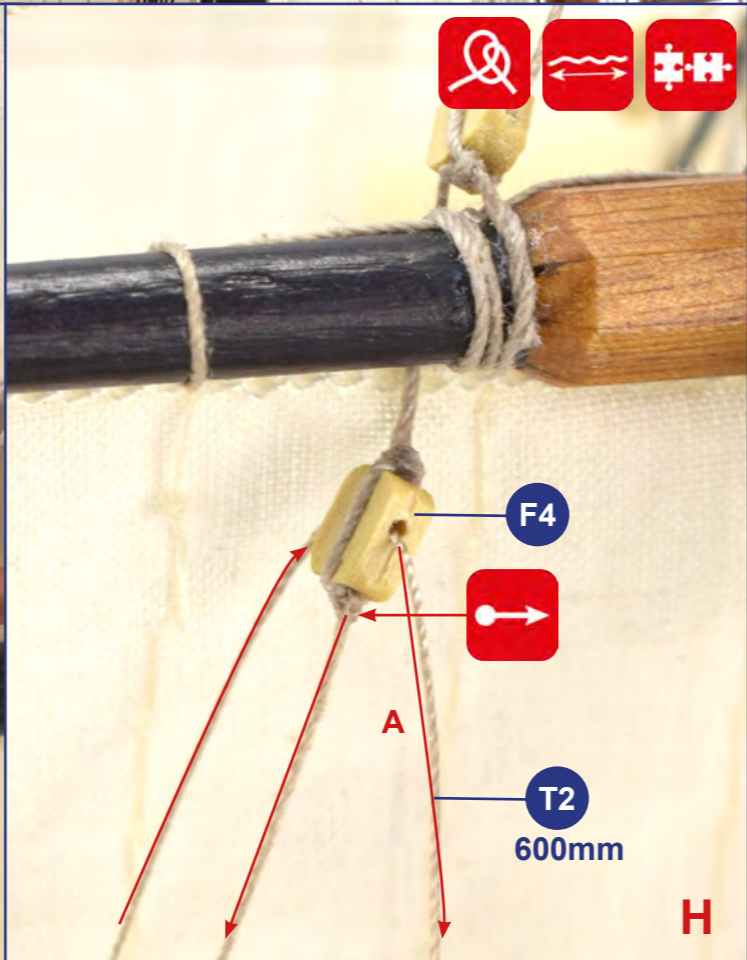
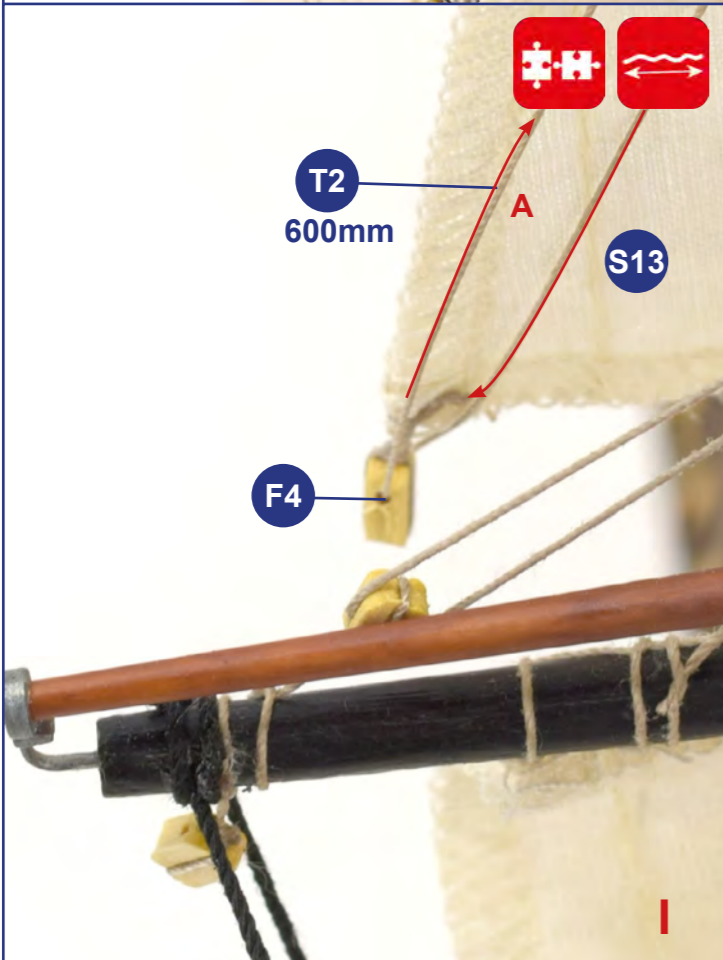
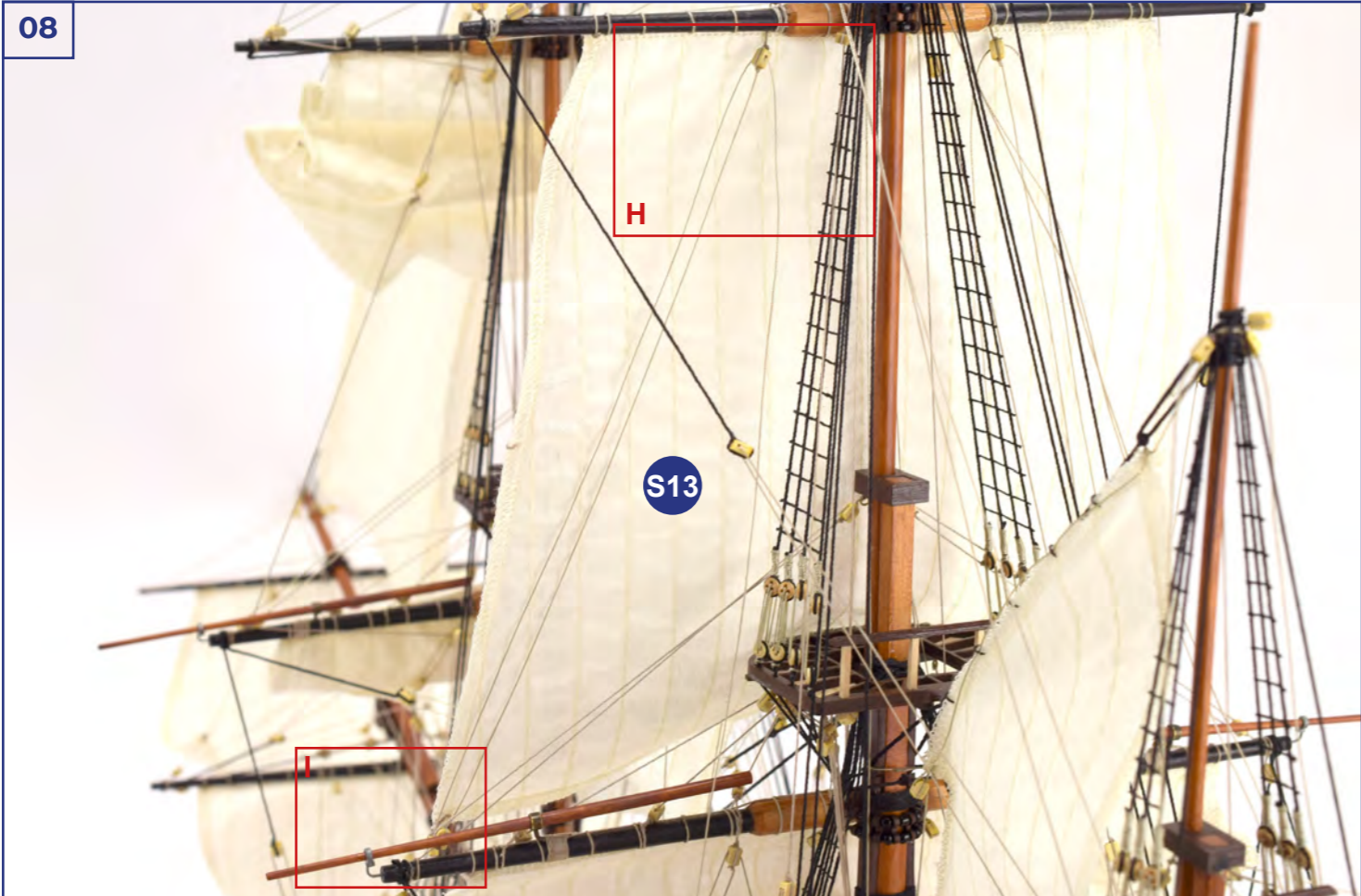

09

MAIN MAST



S13

A B C



LEFT VIEW

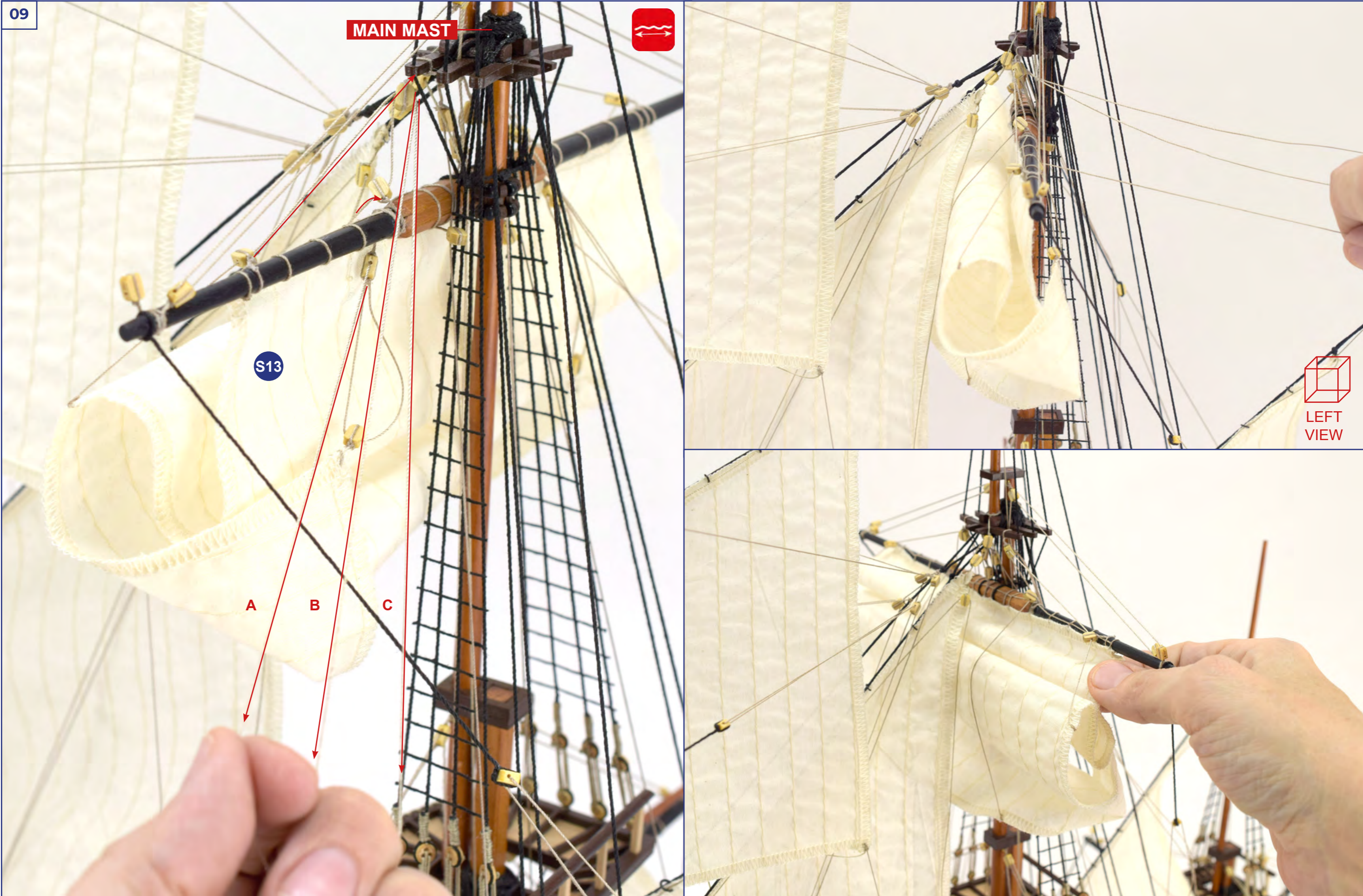

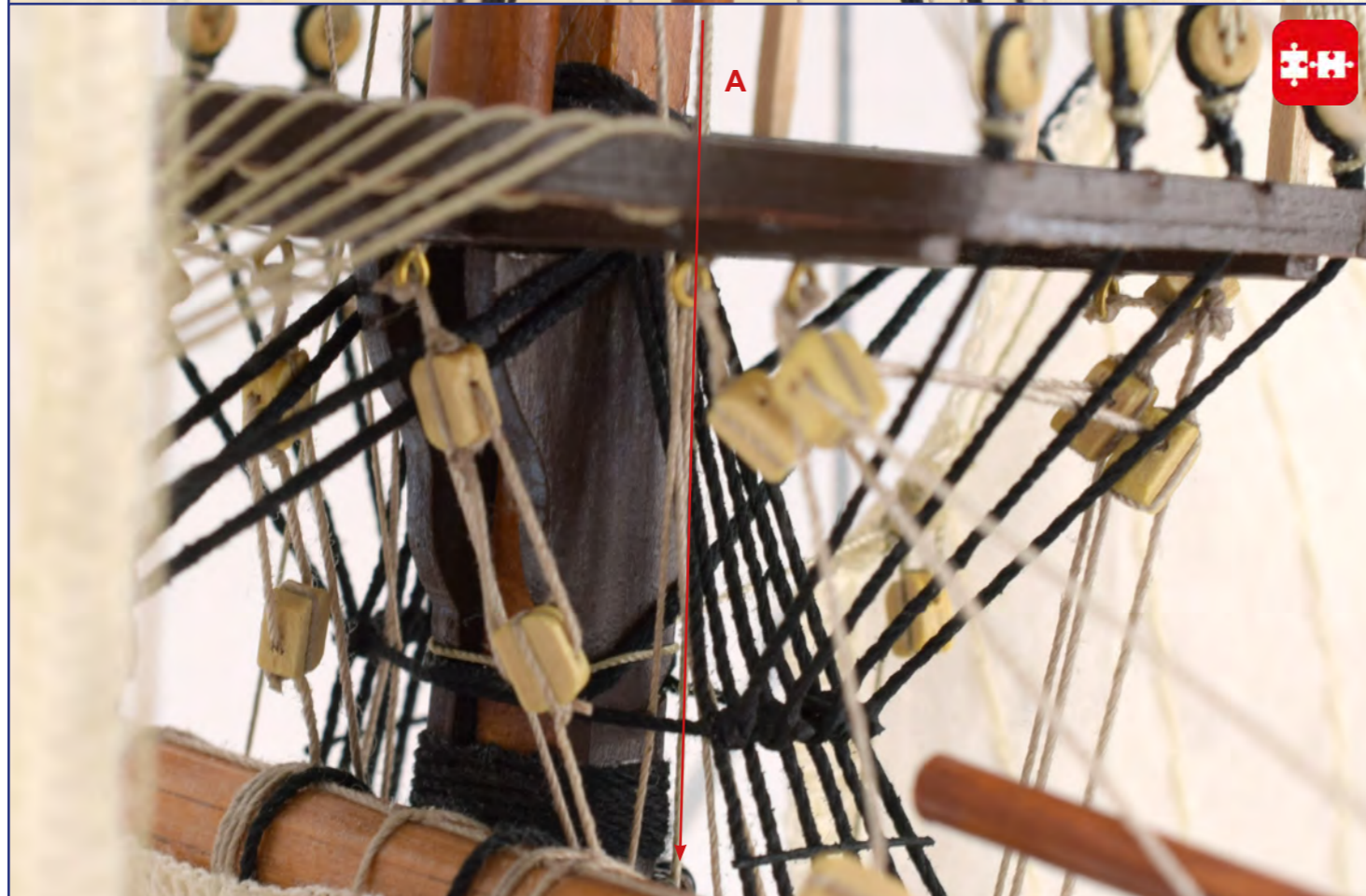
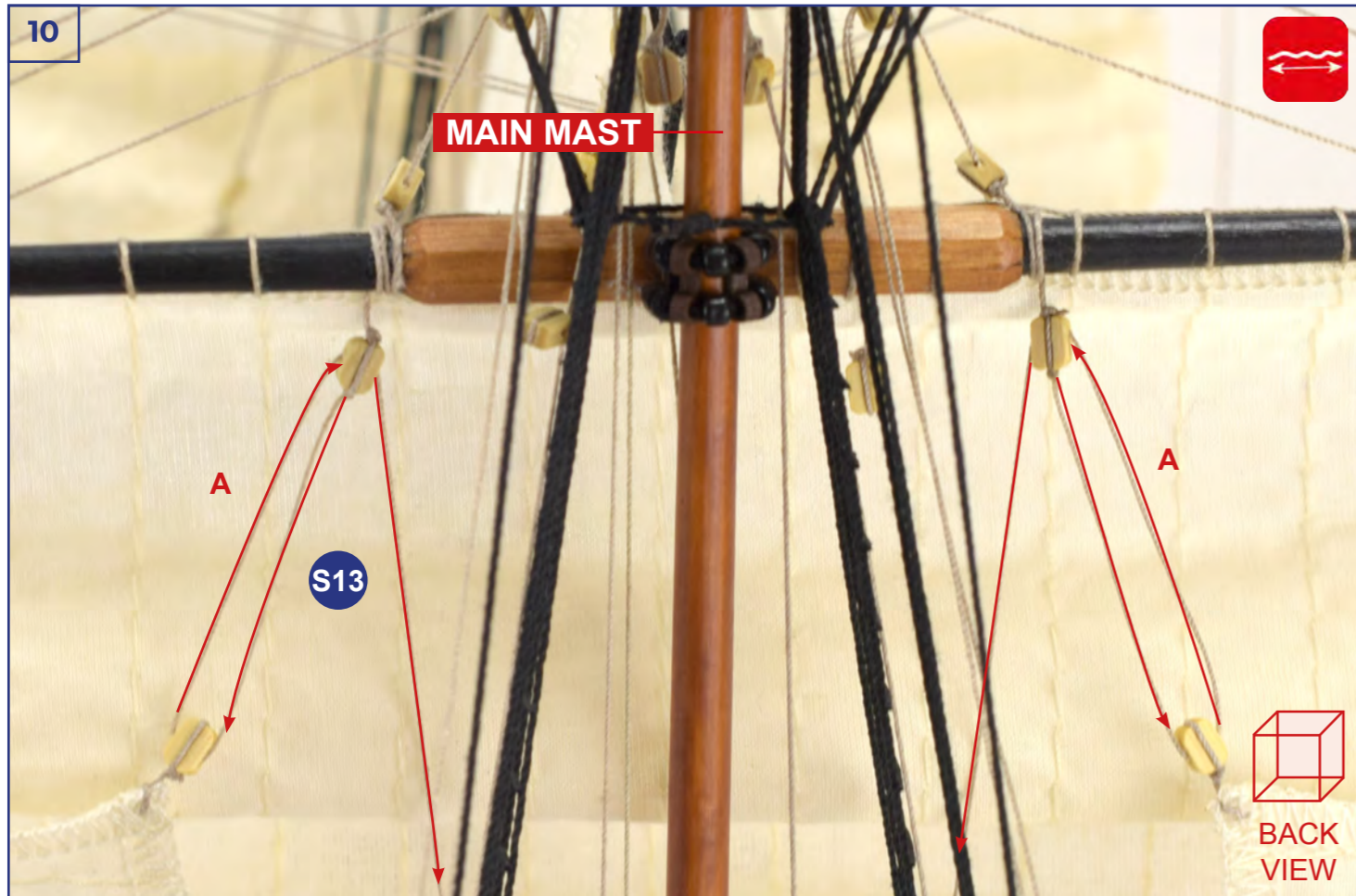

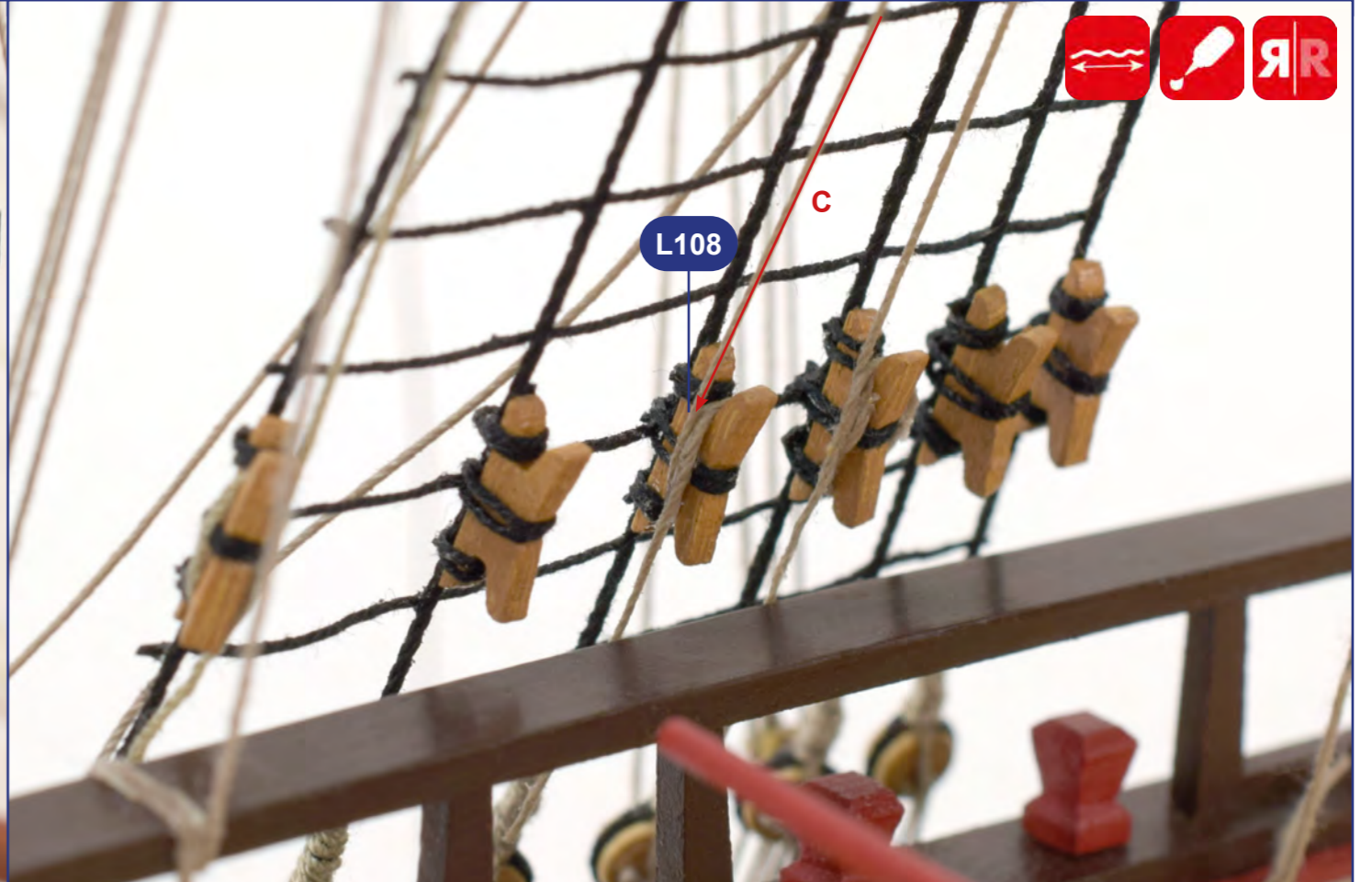

12

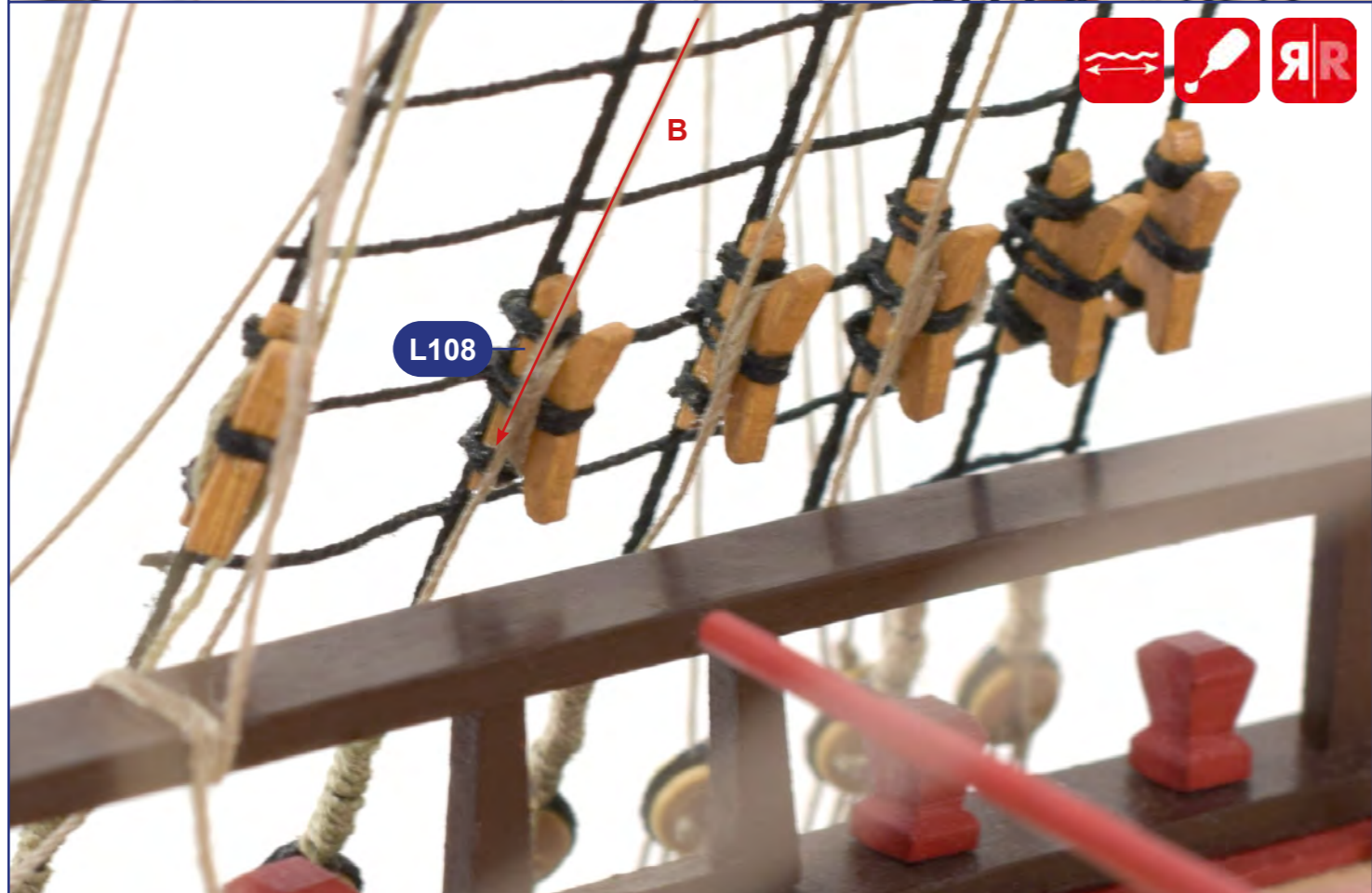
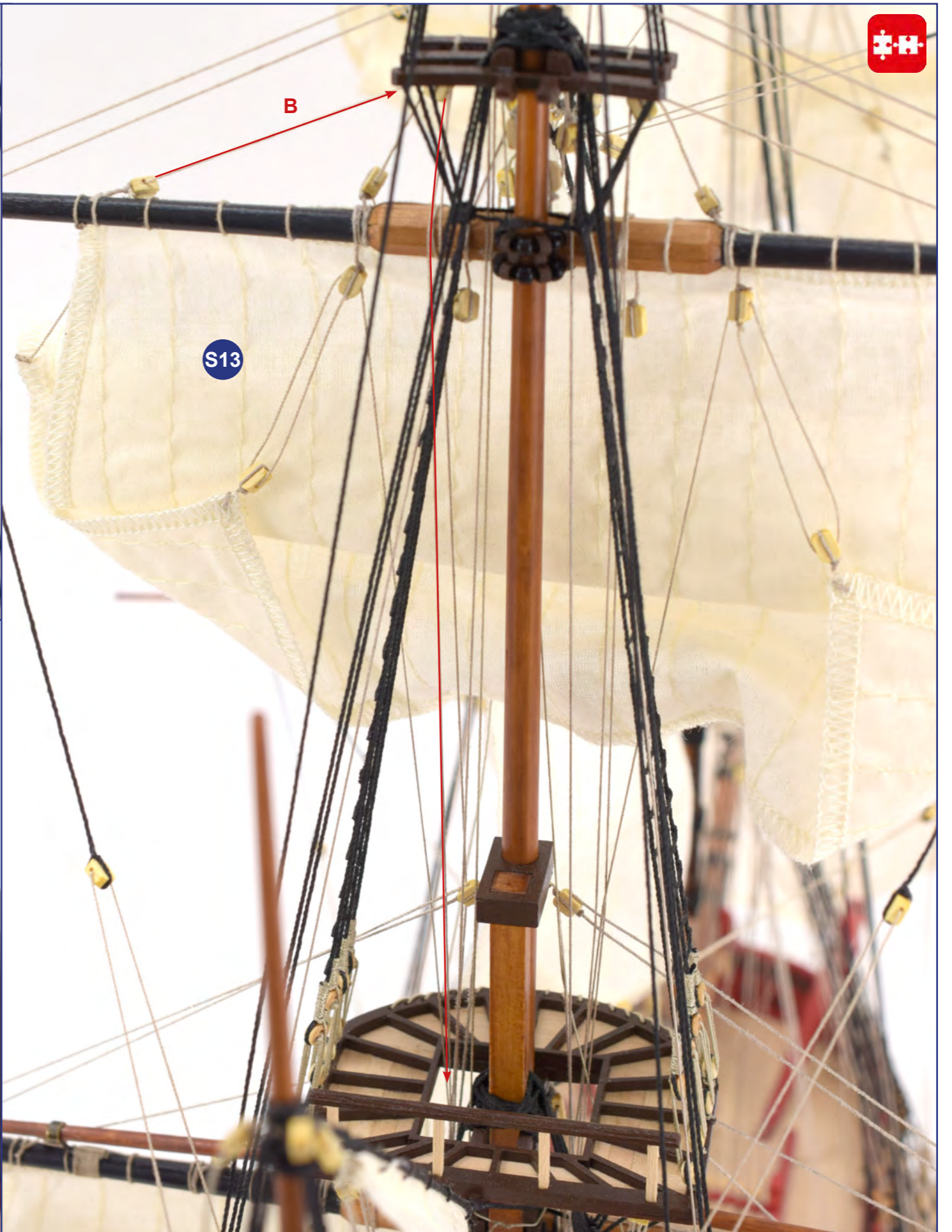

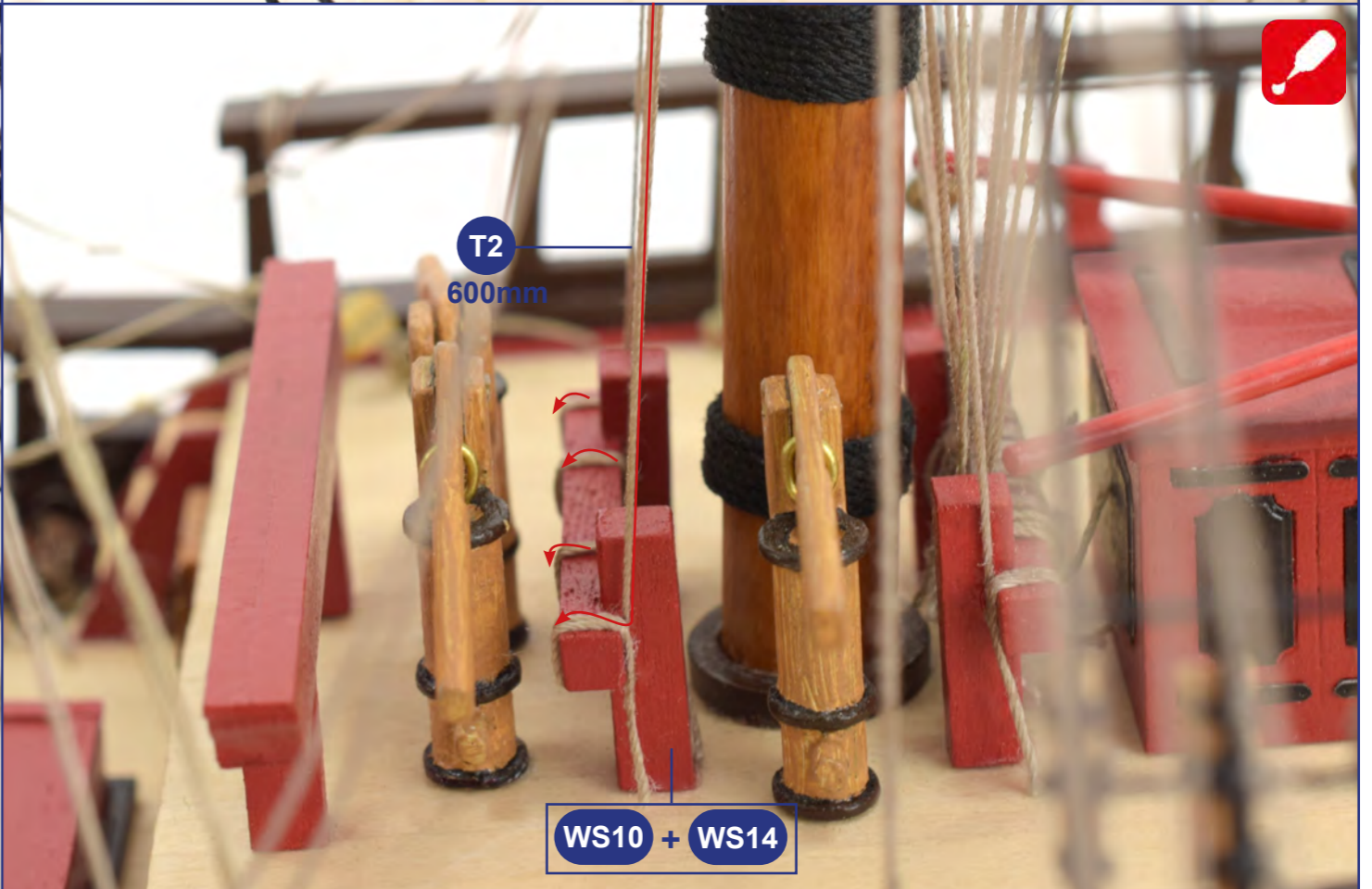
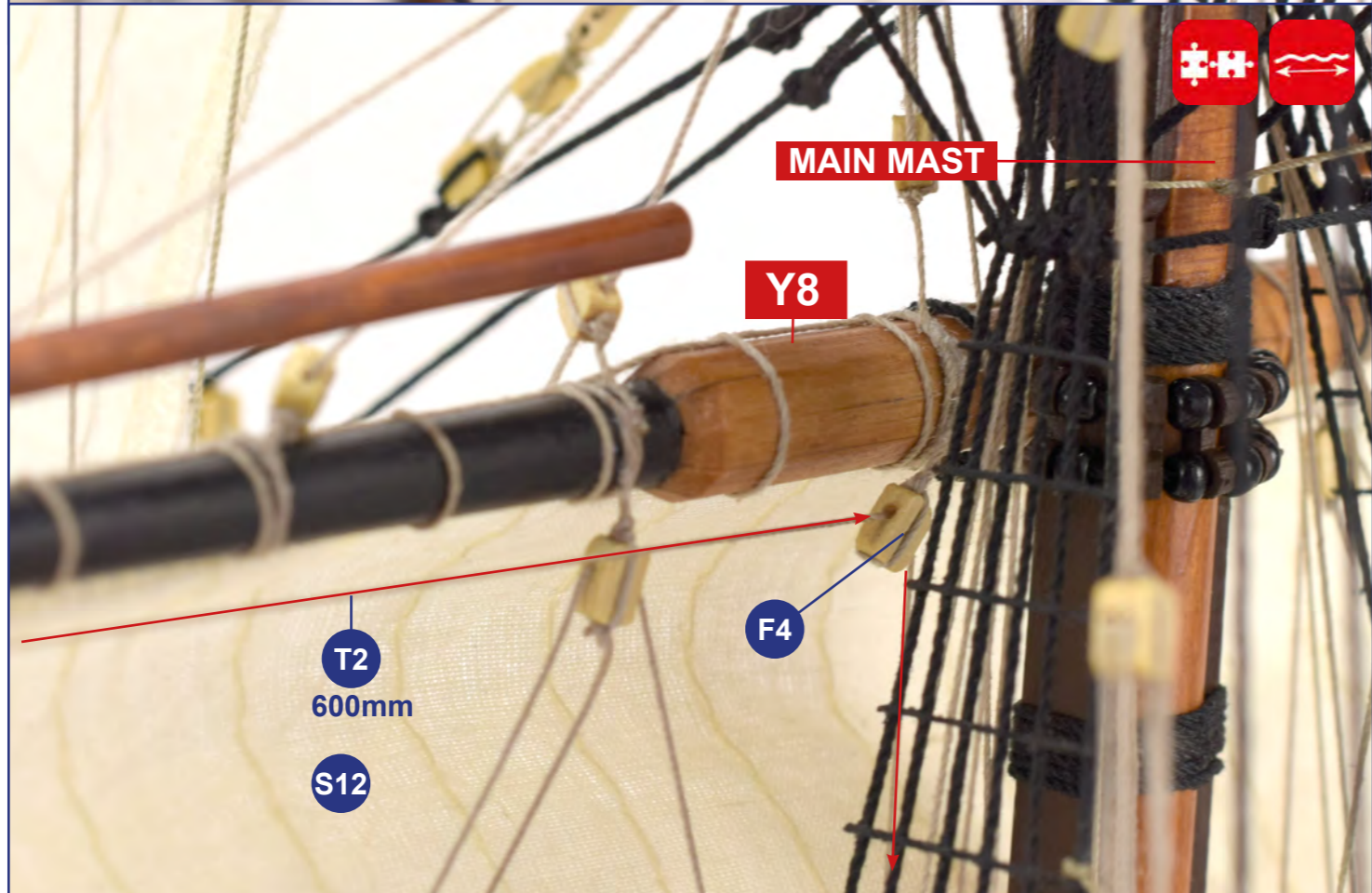
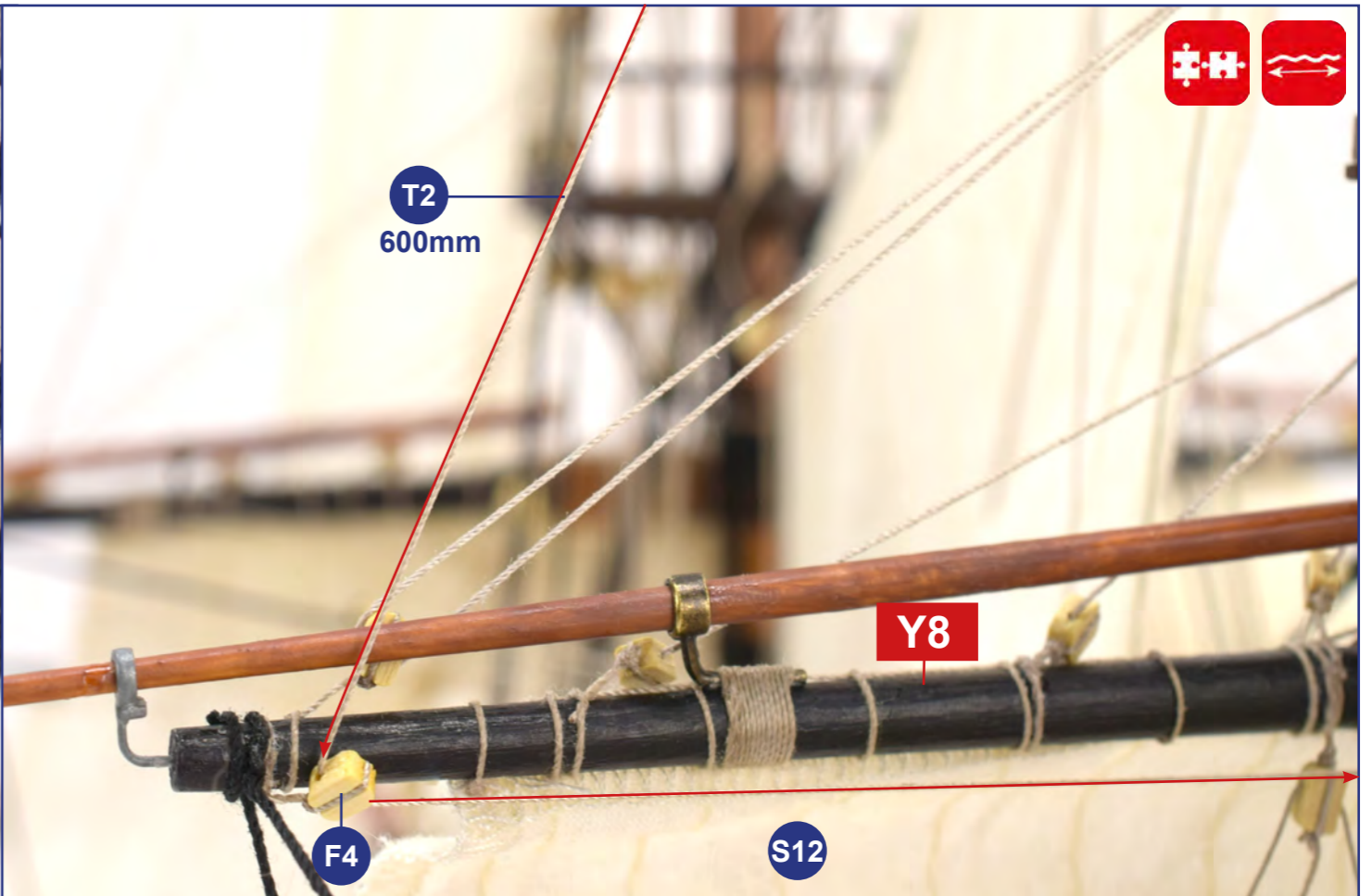
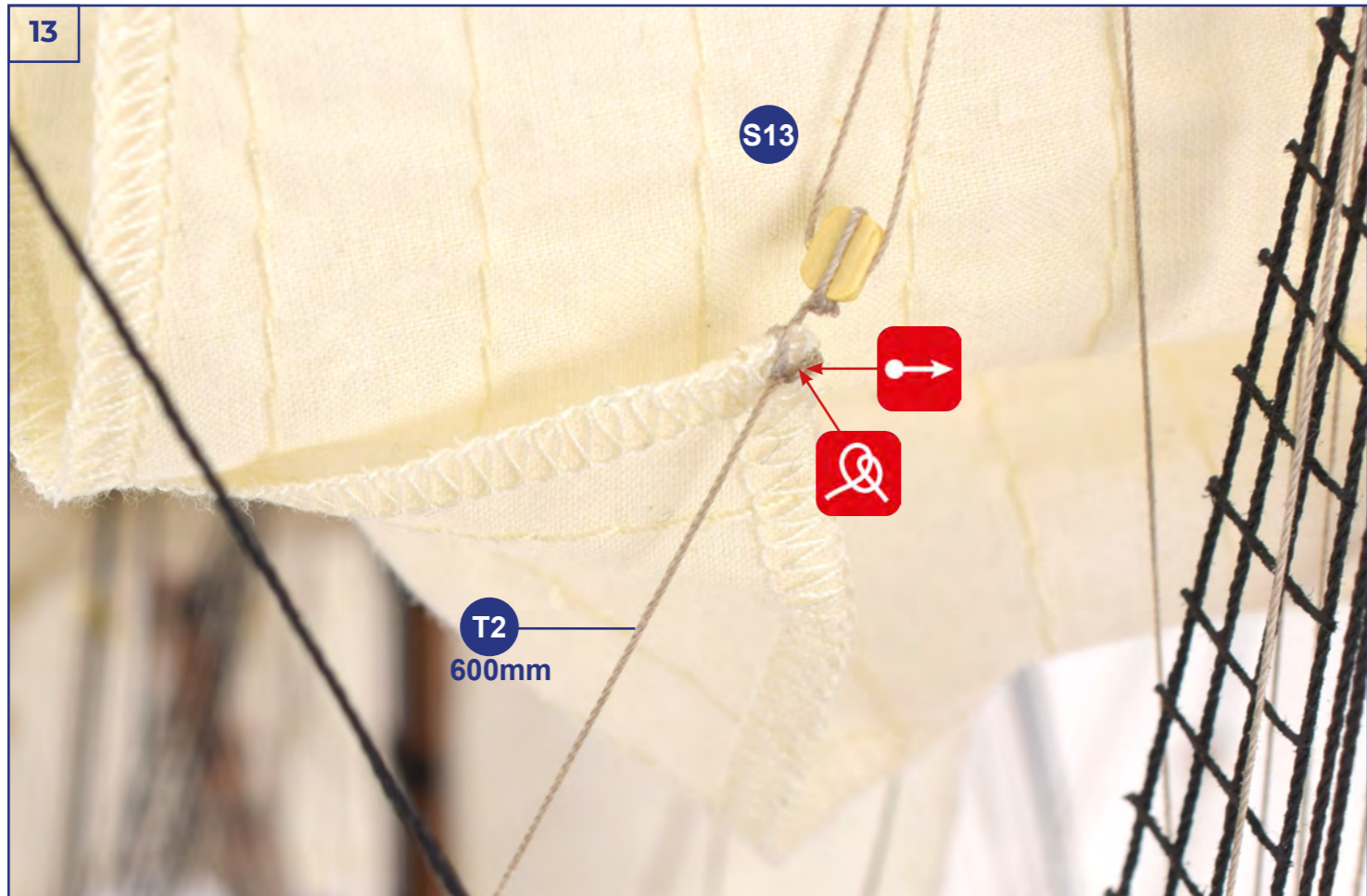

14

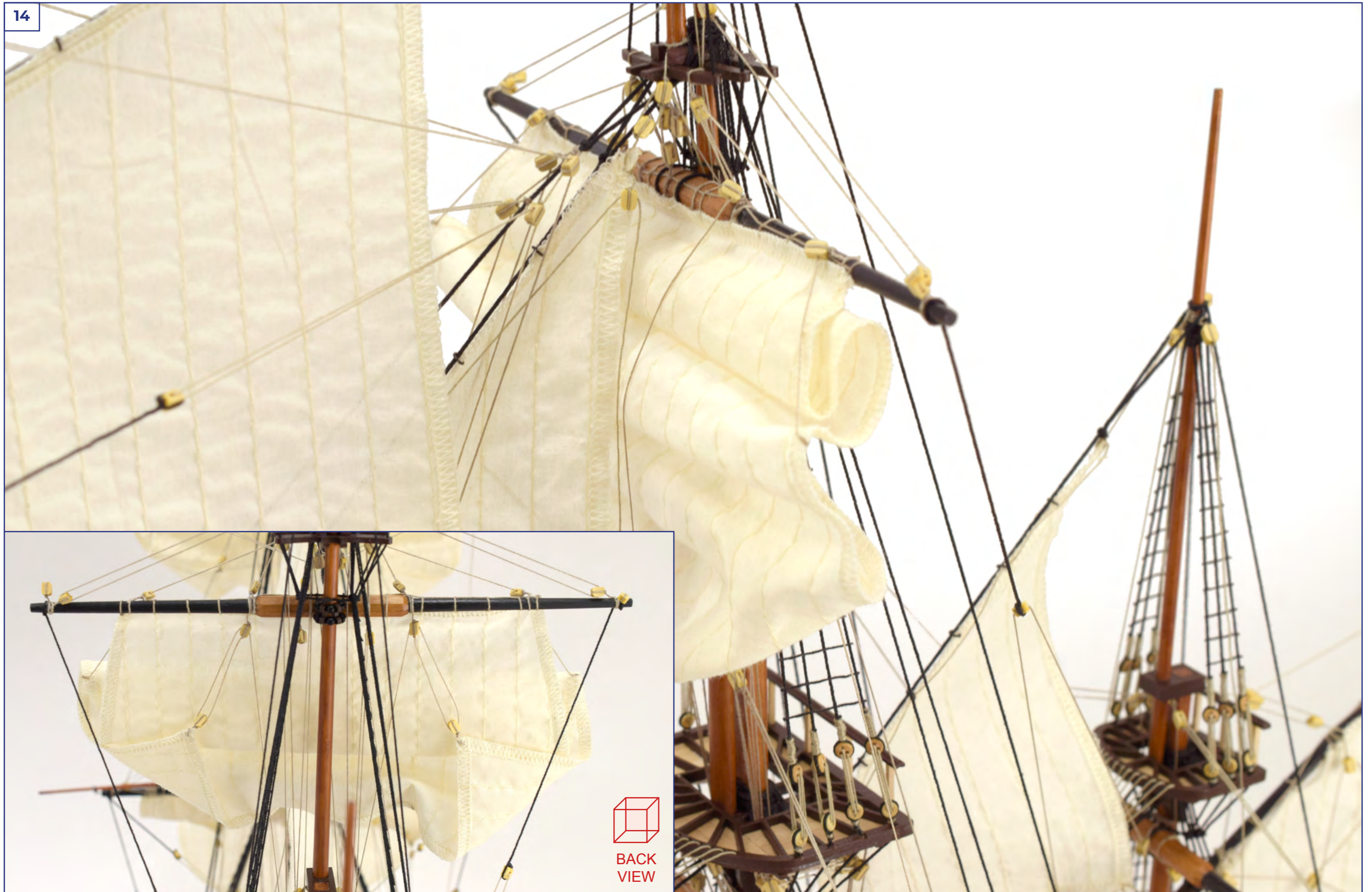

BACK
VIEW

01

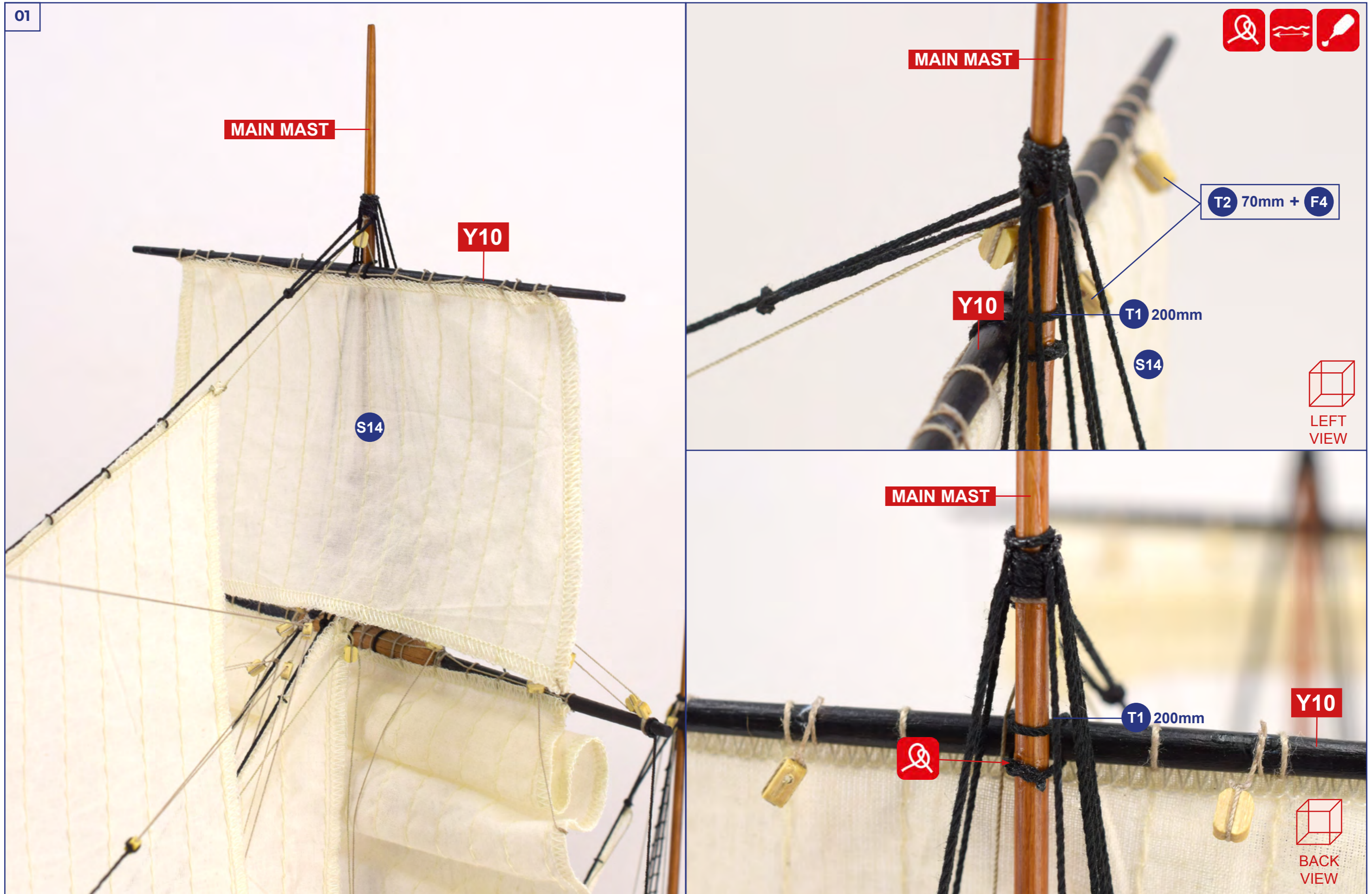

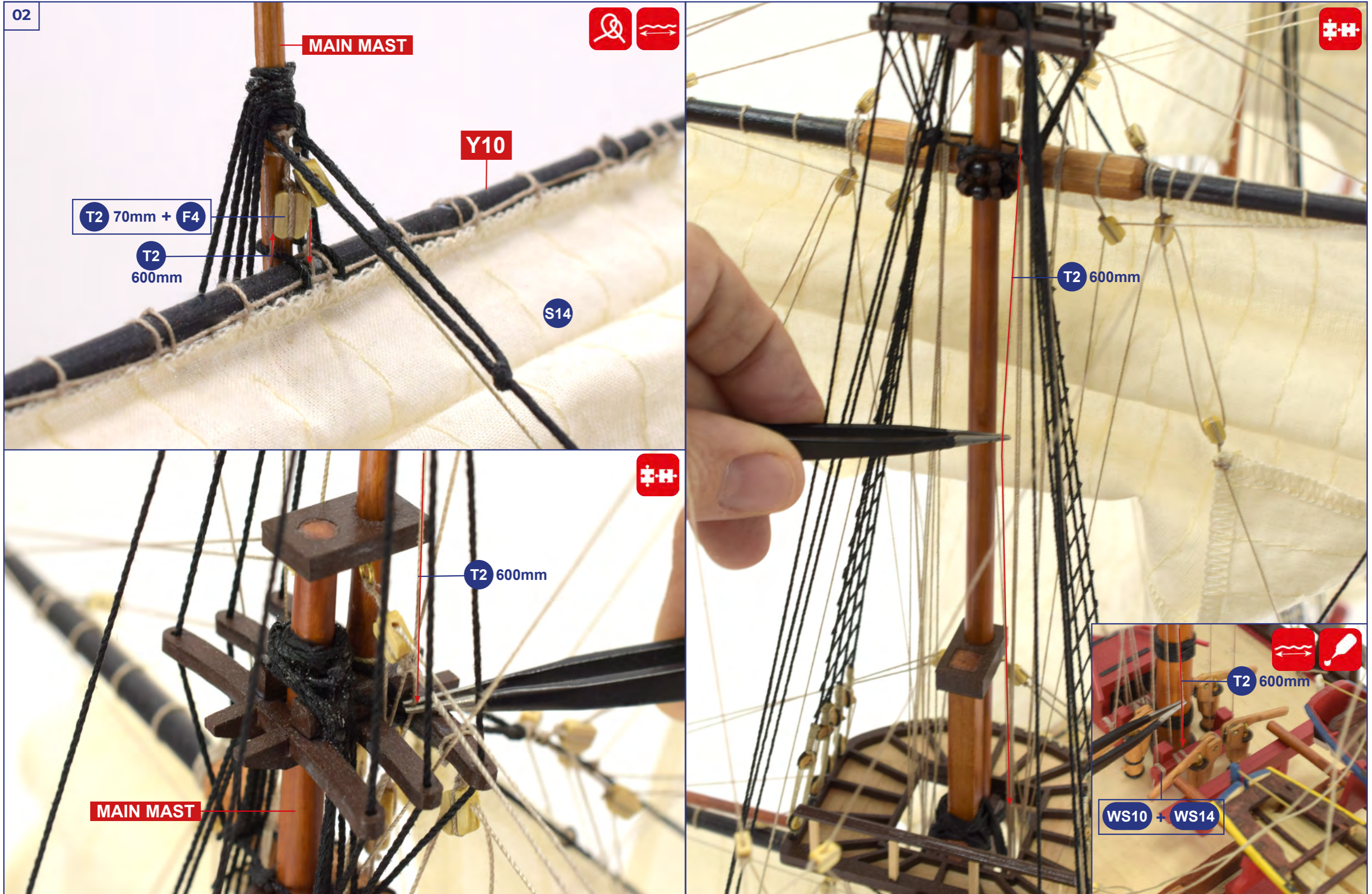

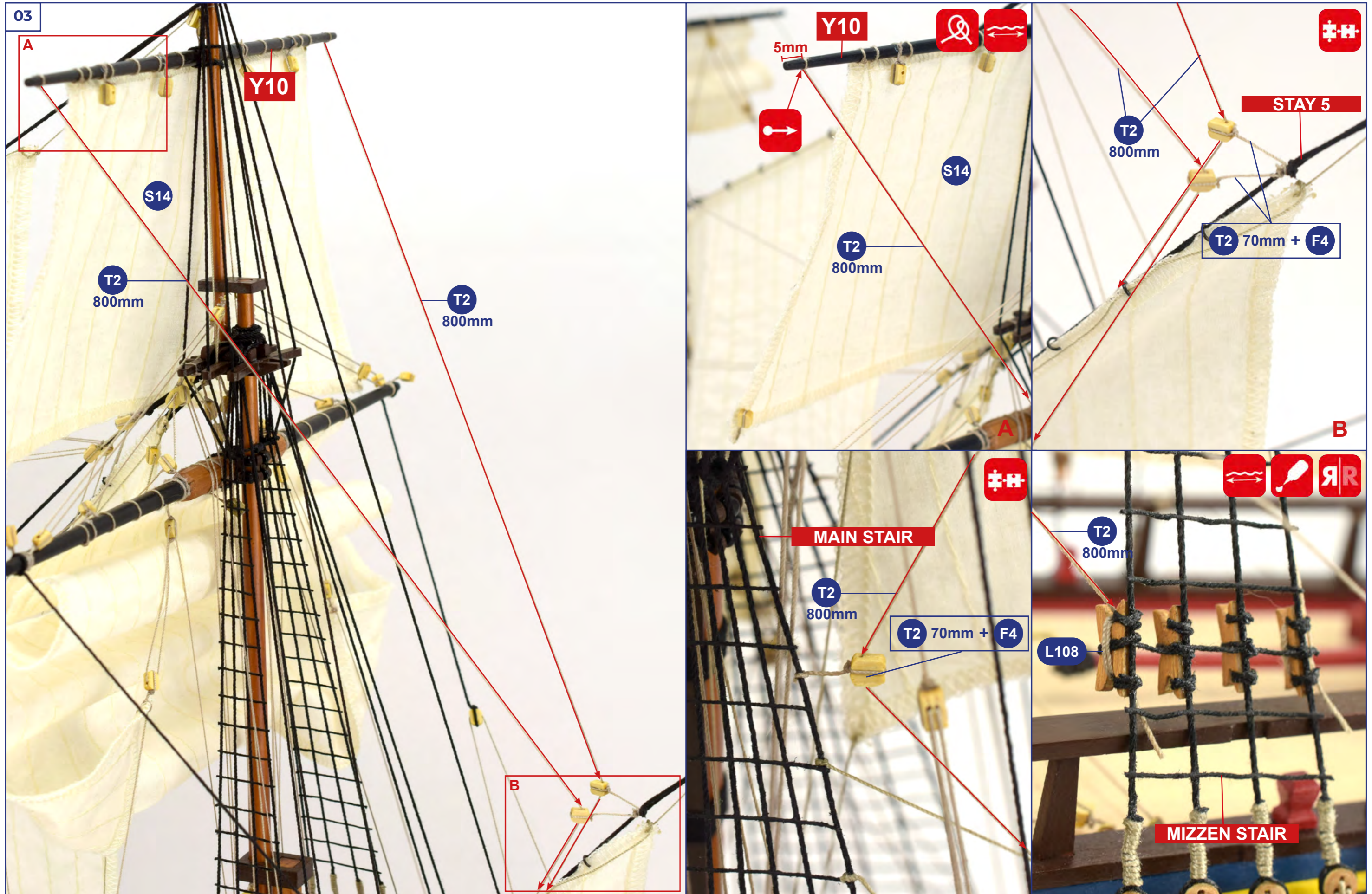

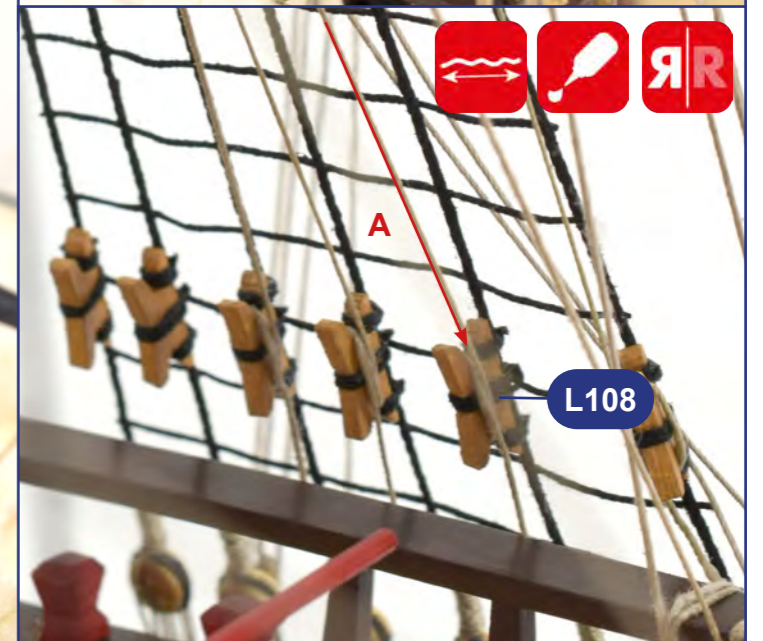
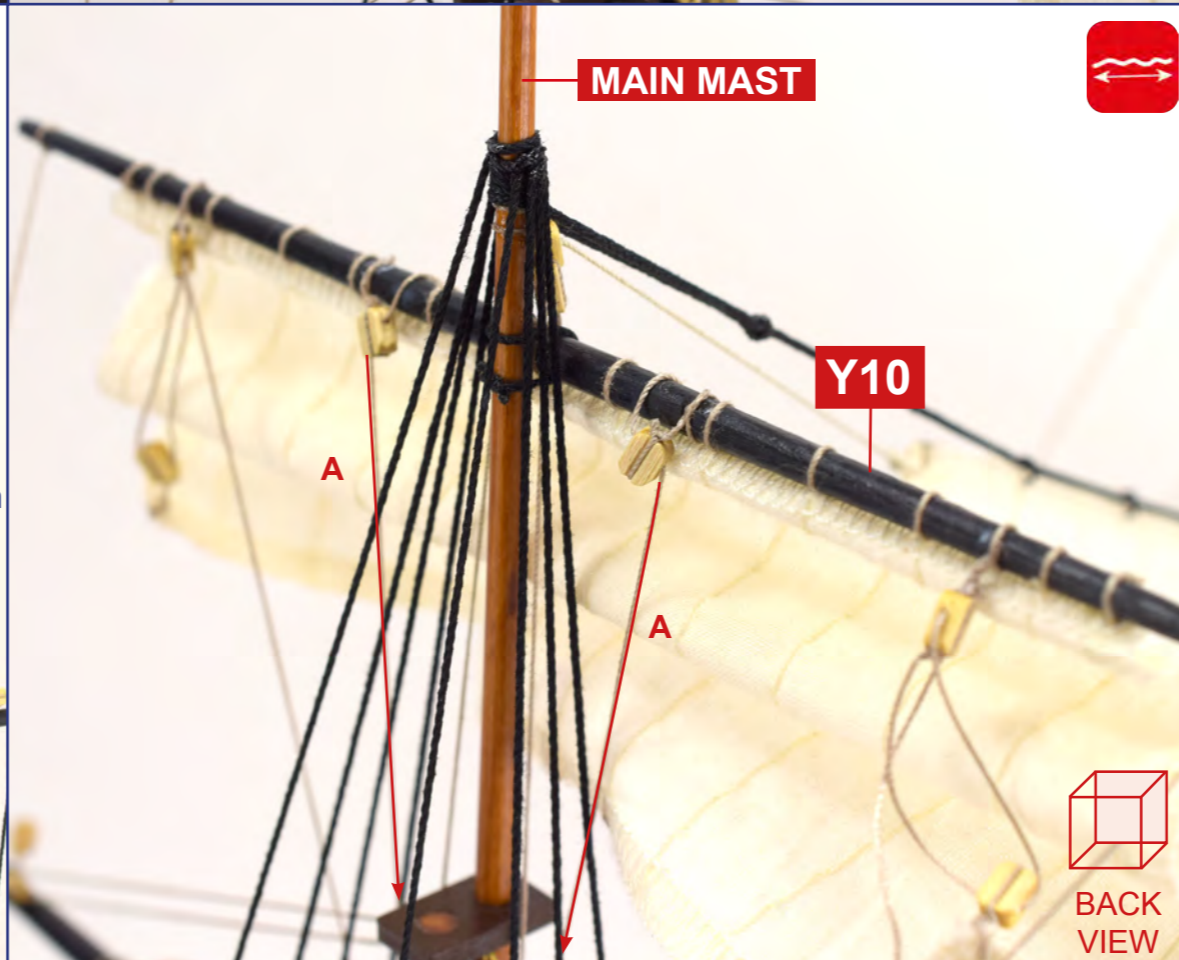
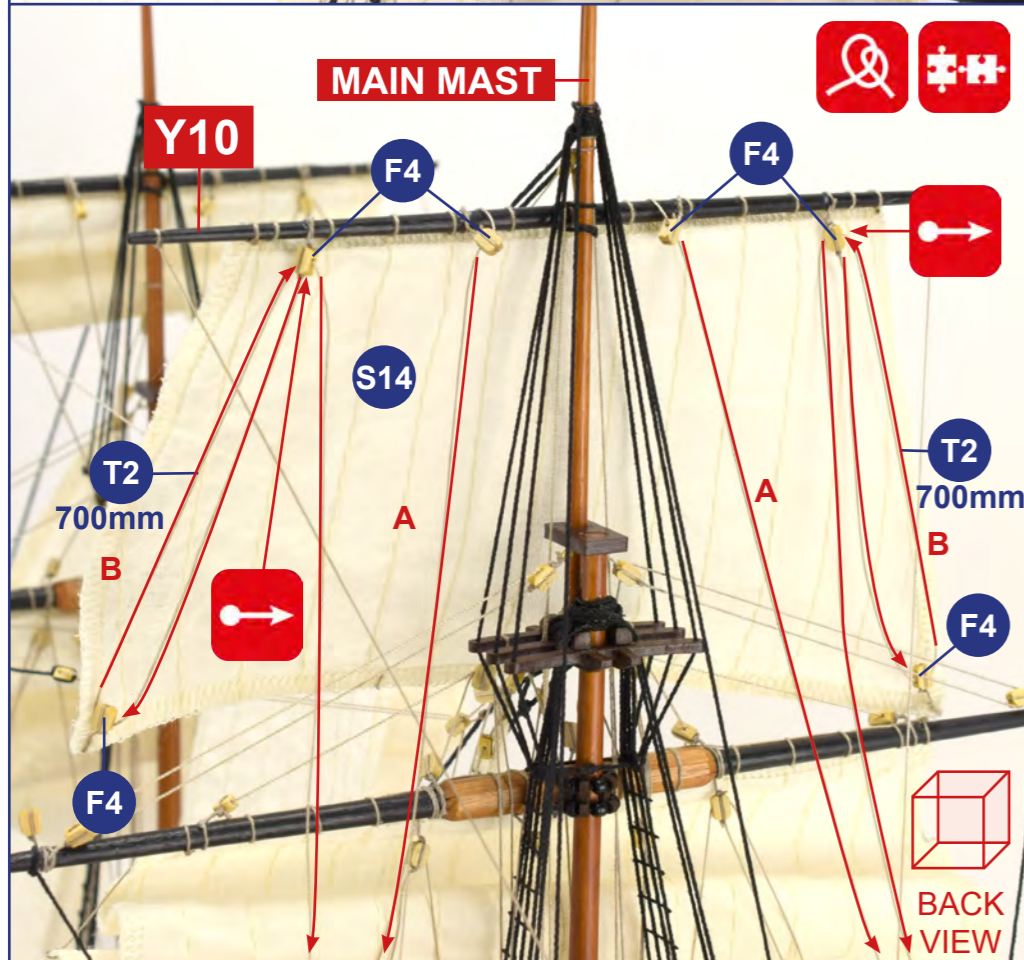
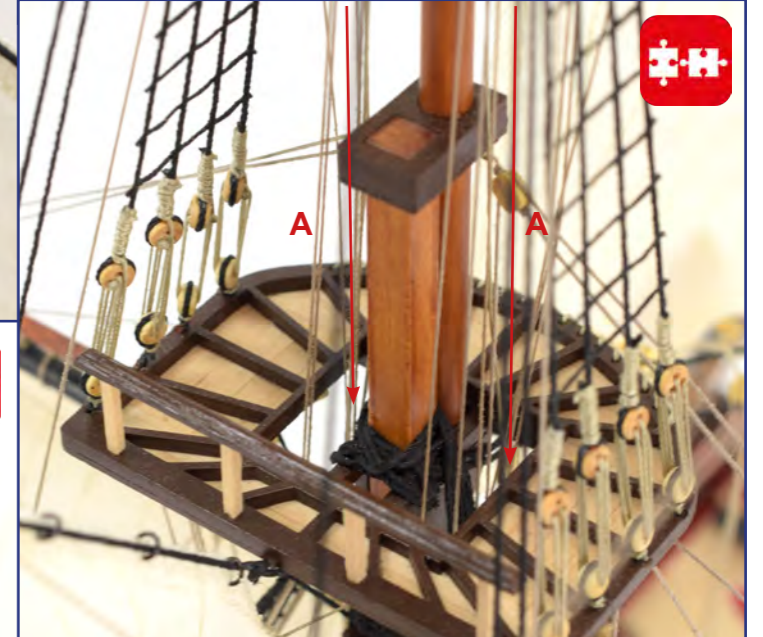
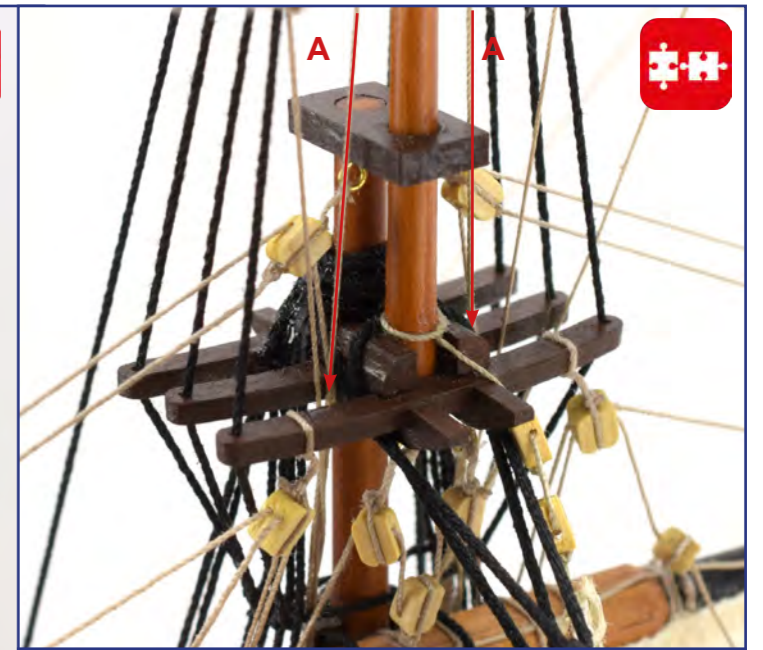
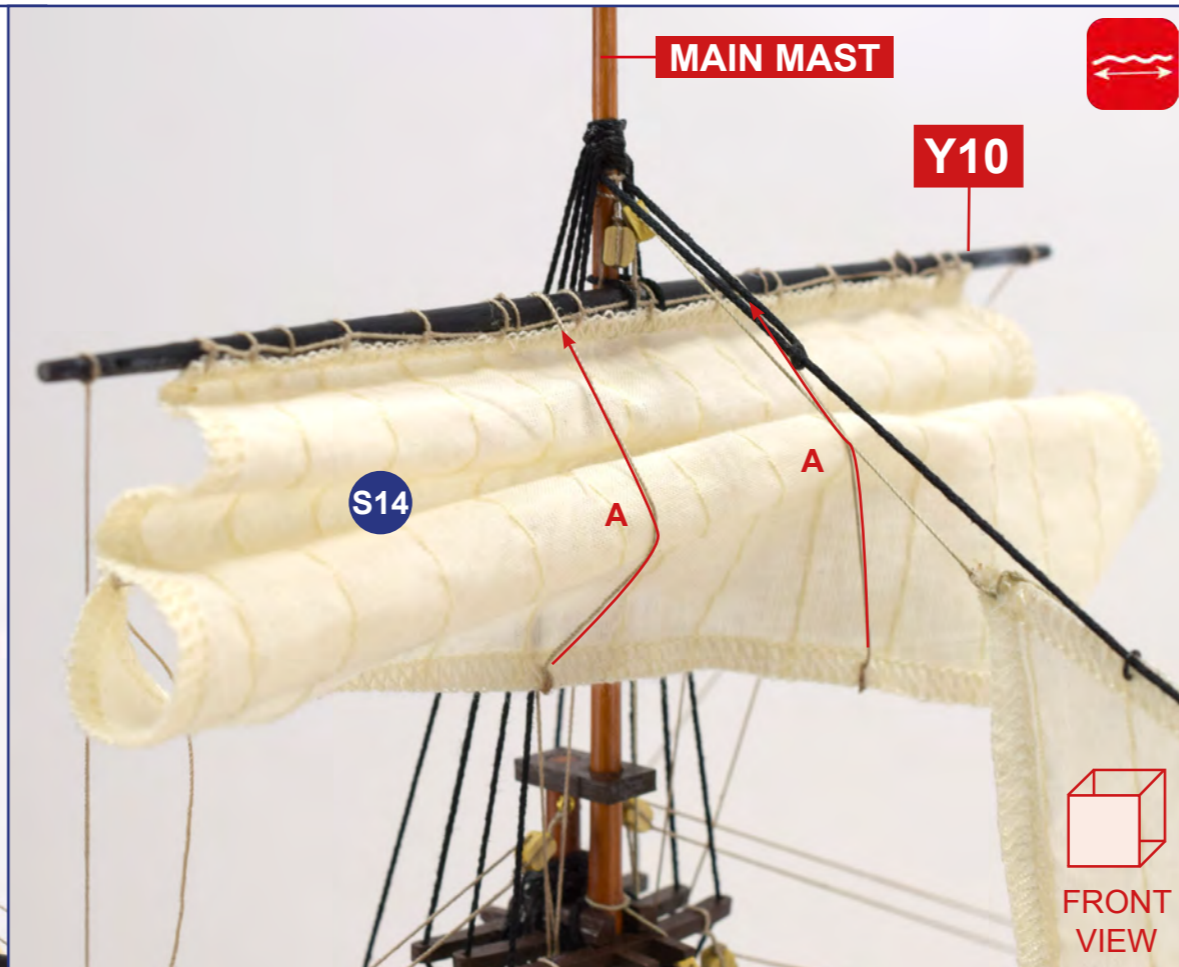
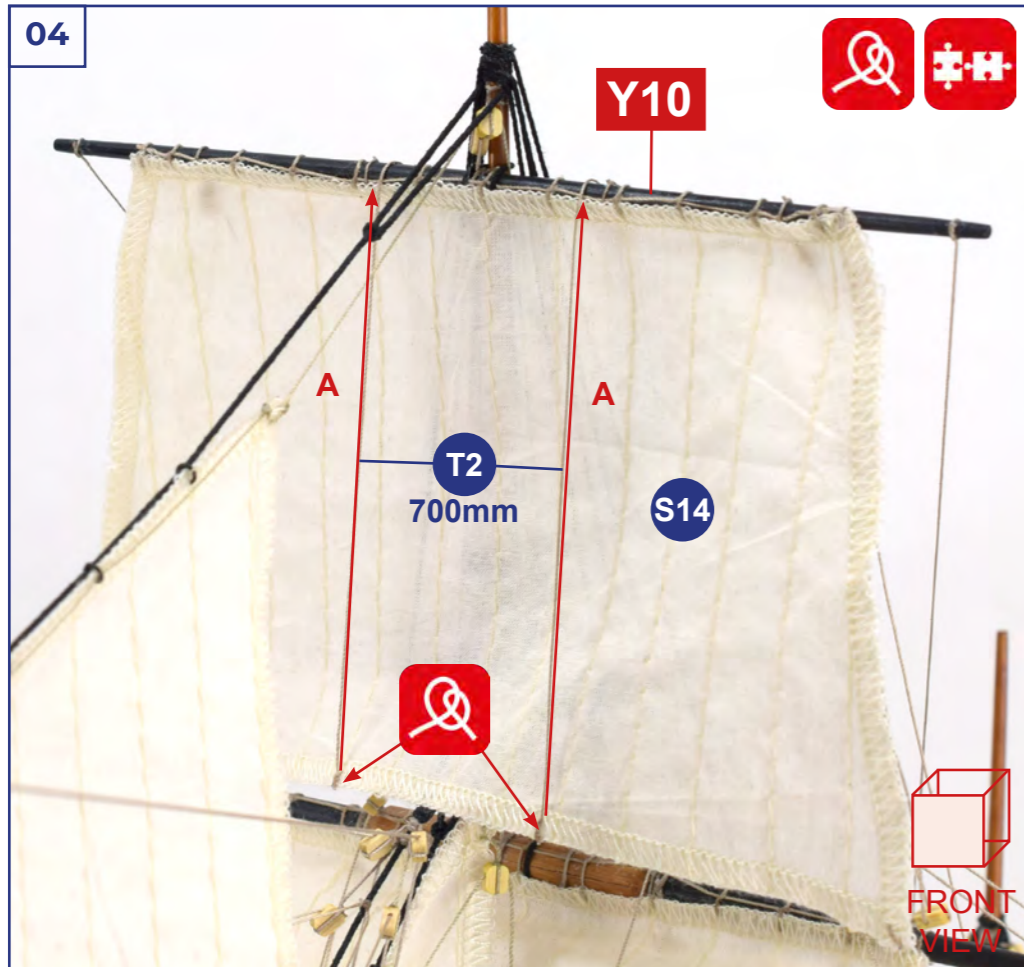

05

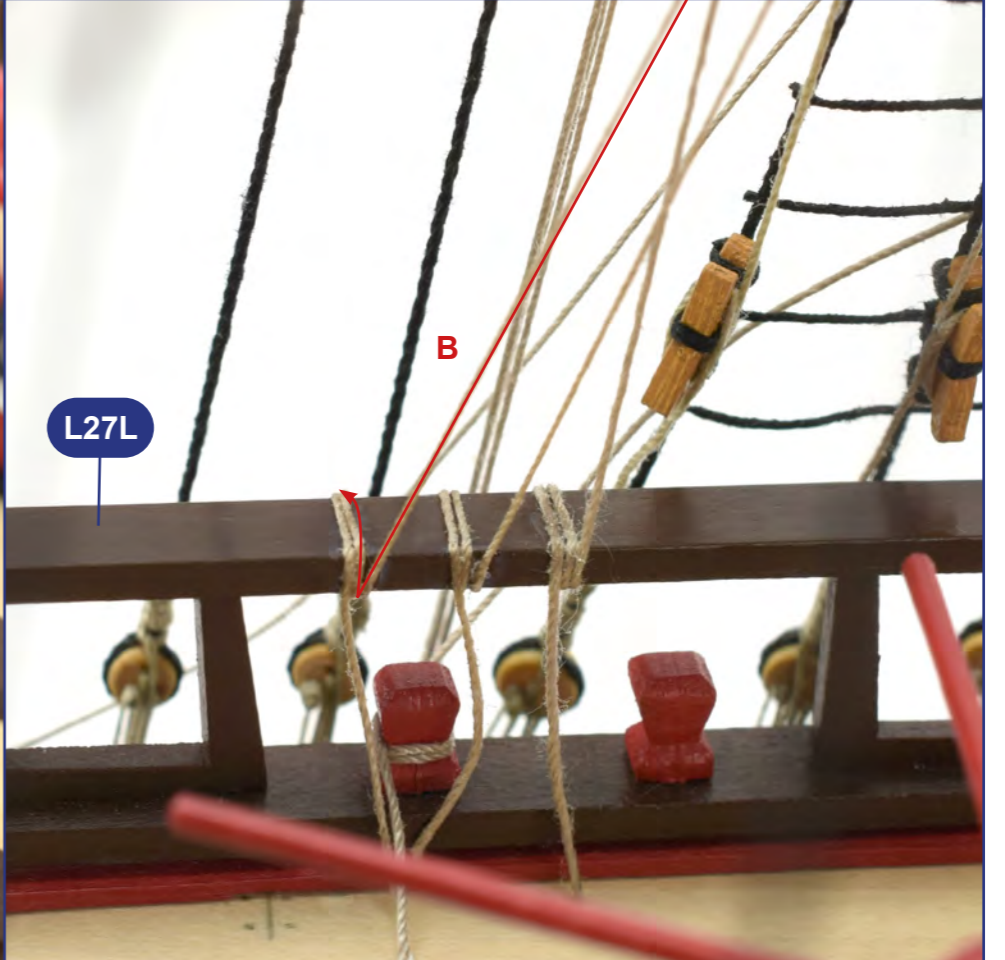
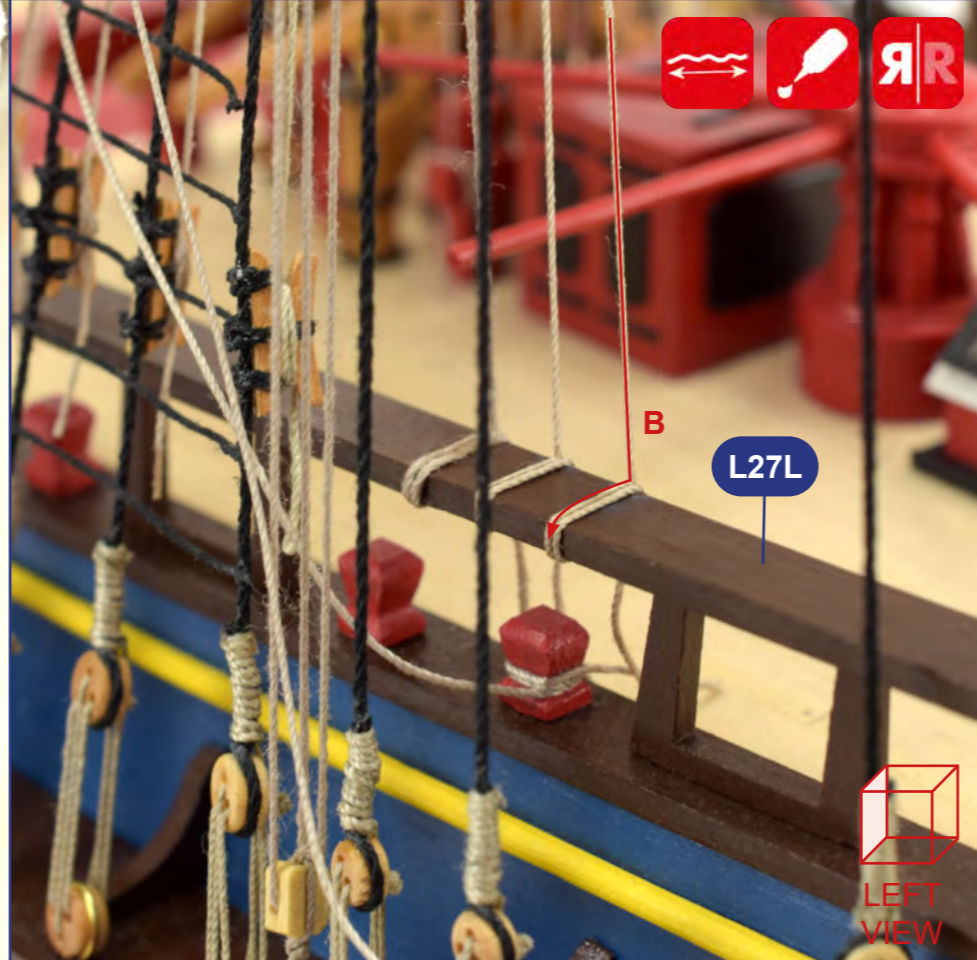
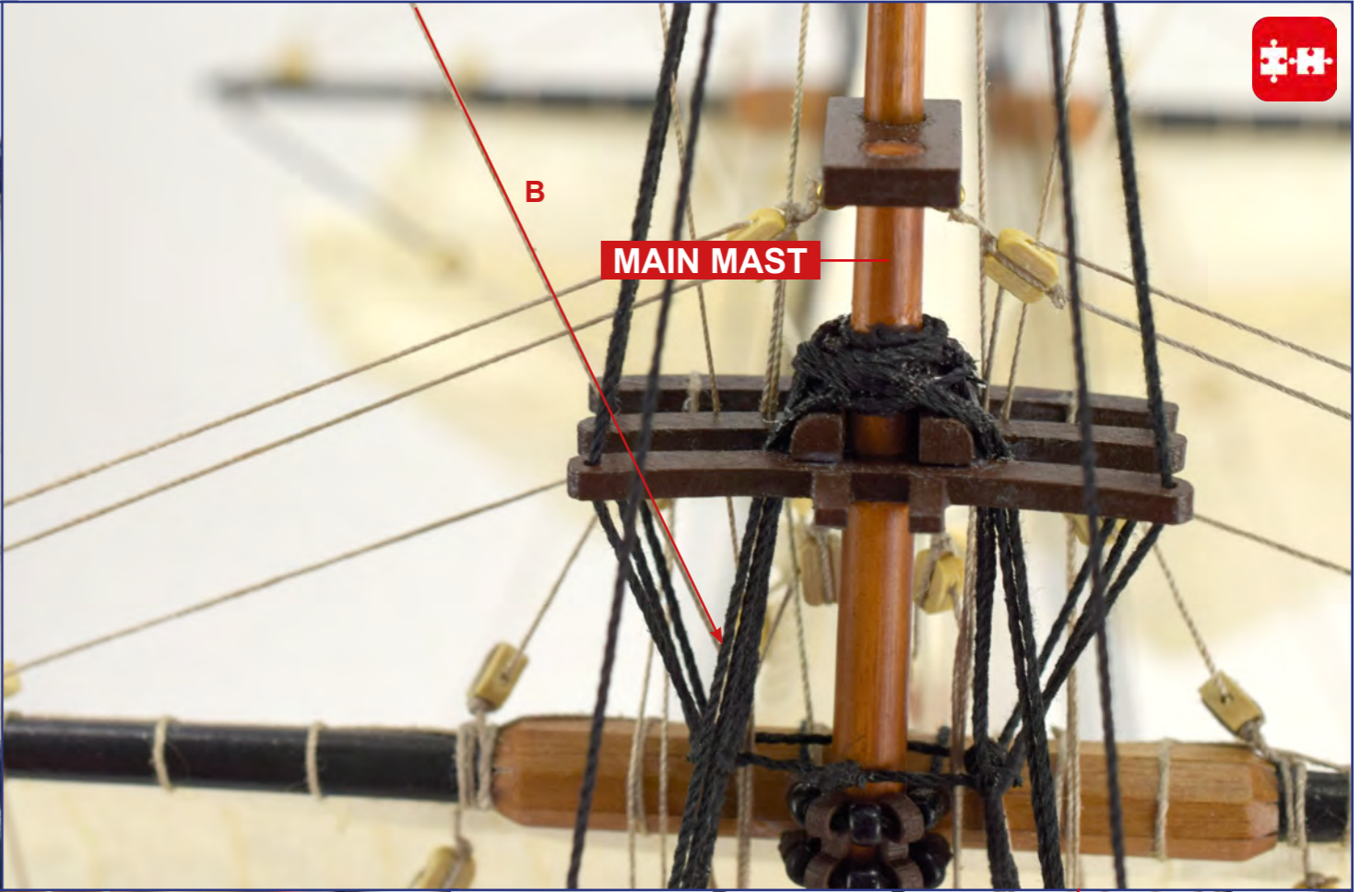
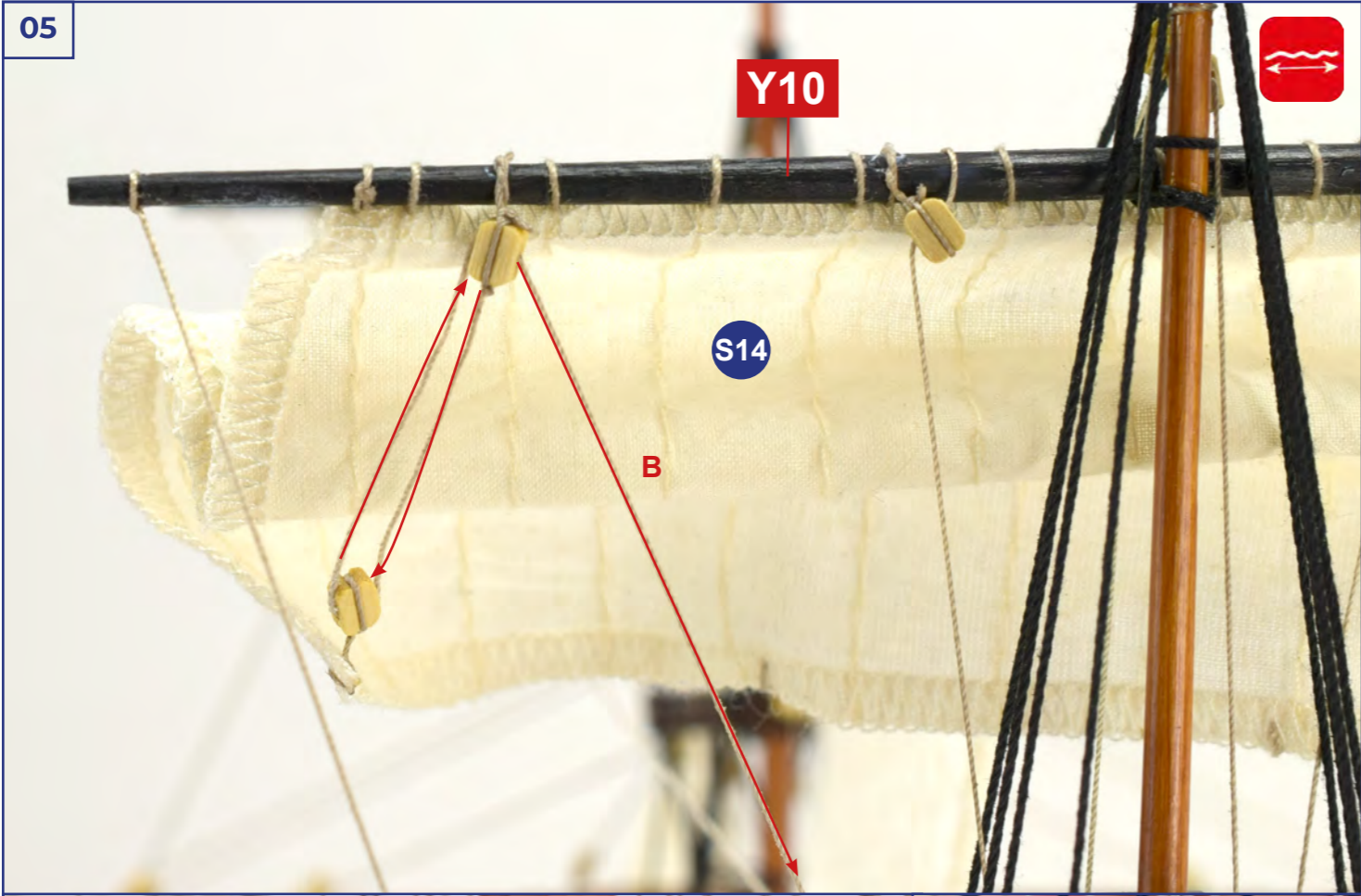

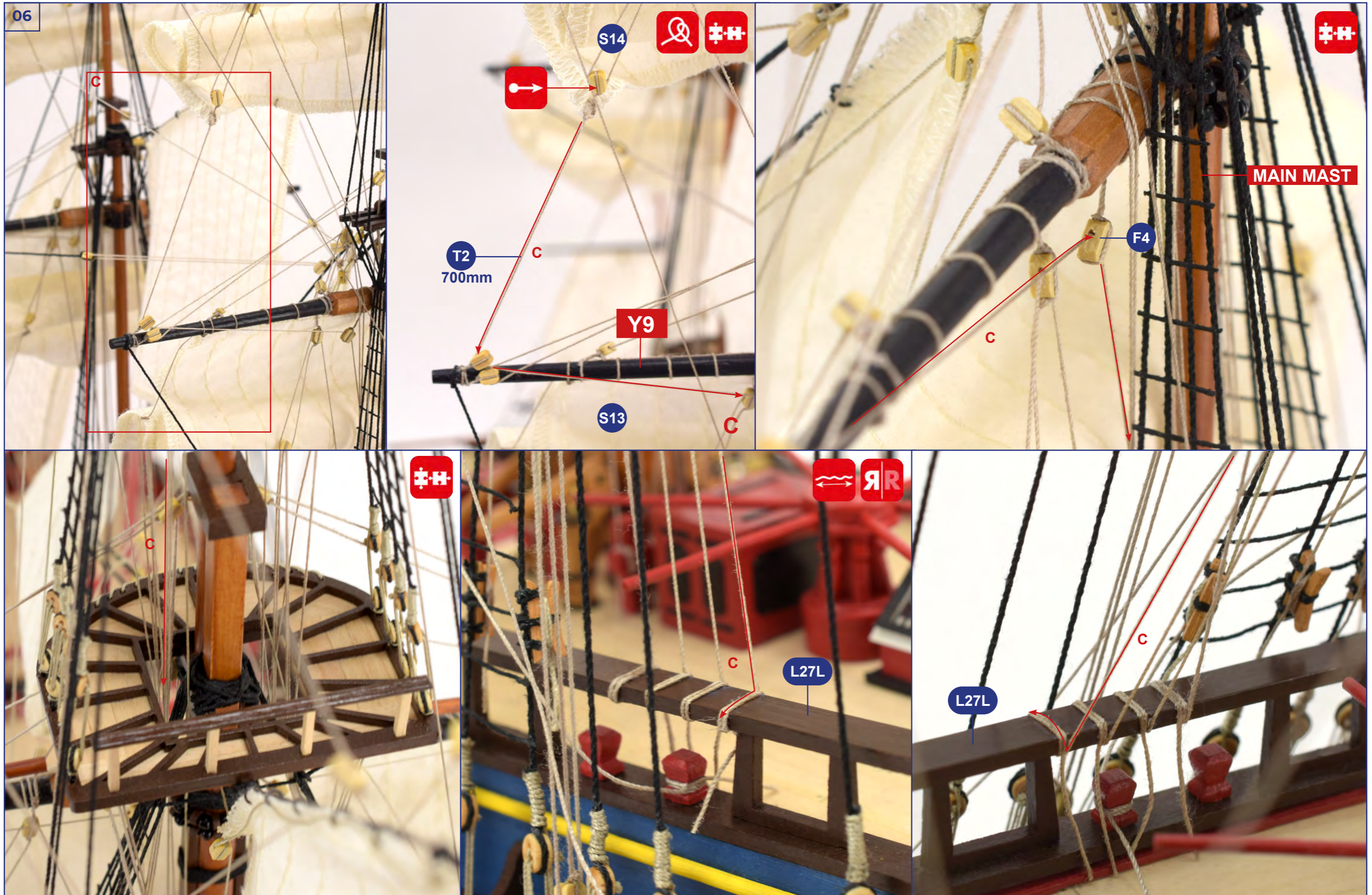

07

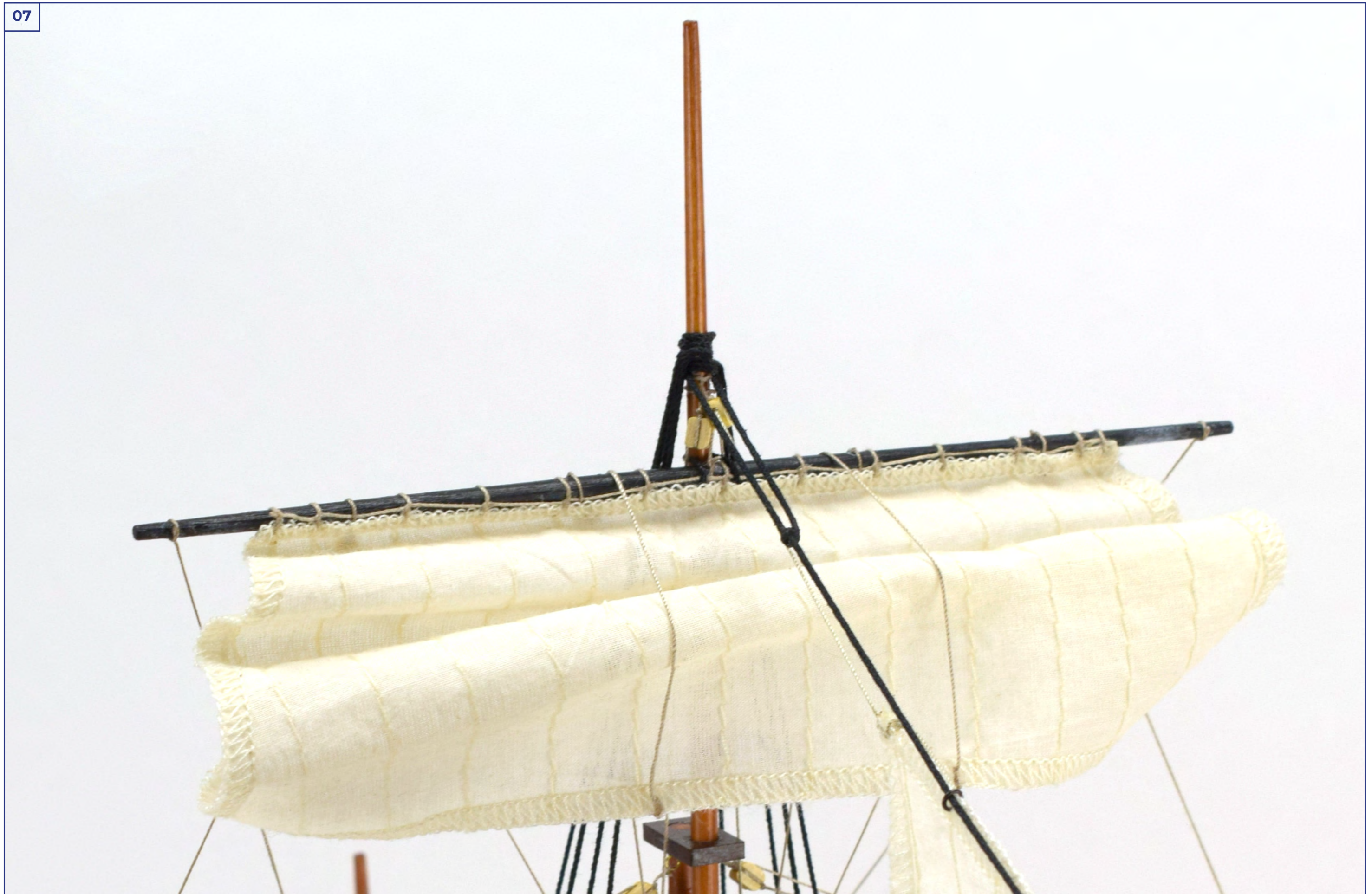

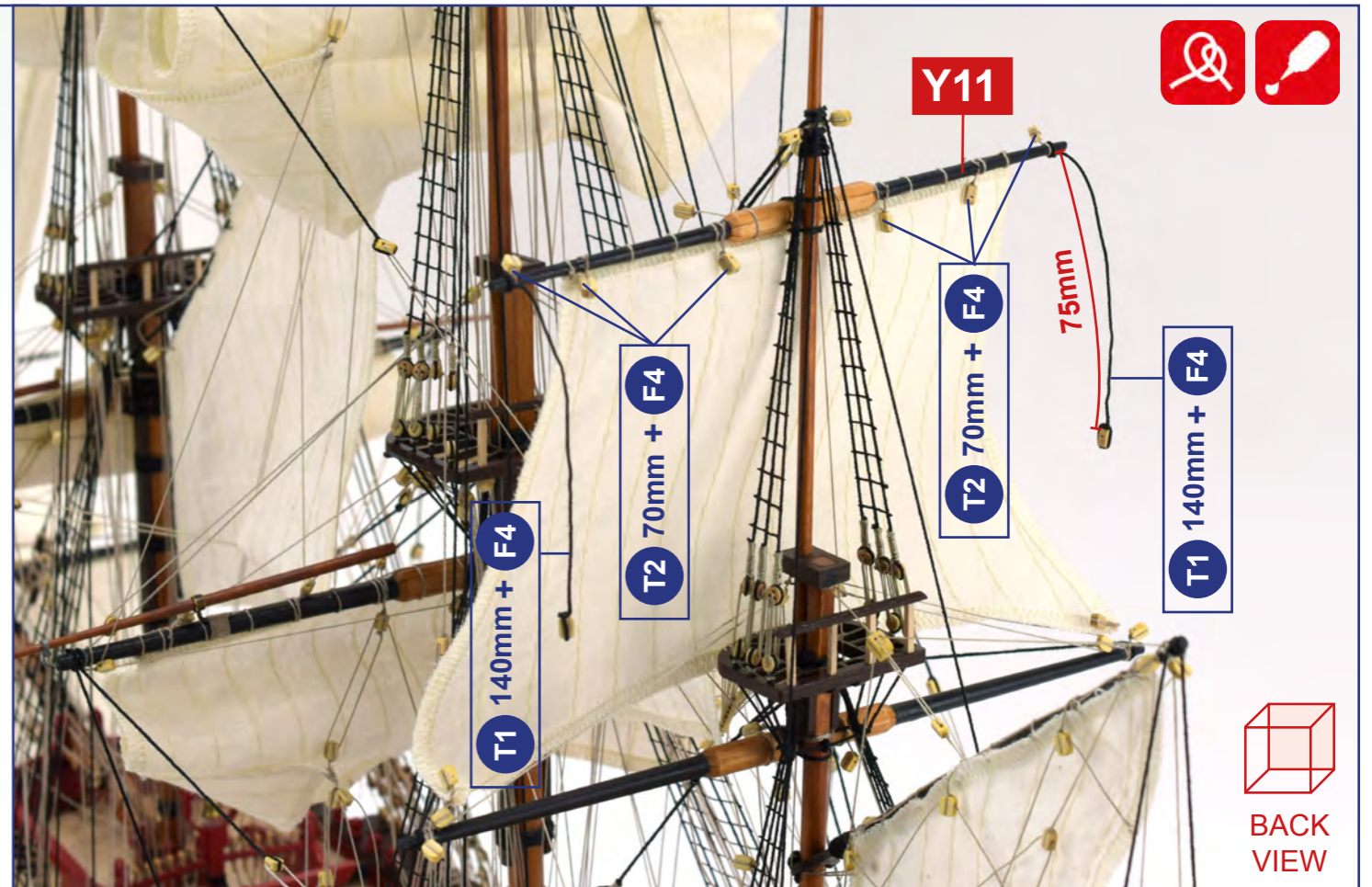

02

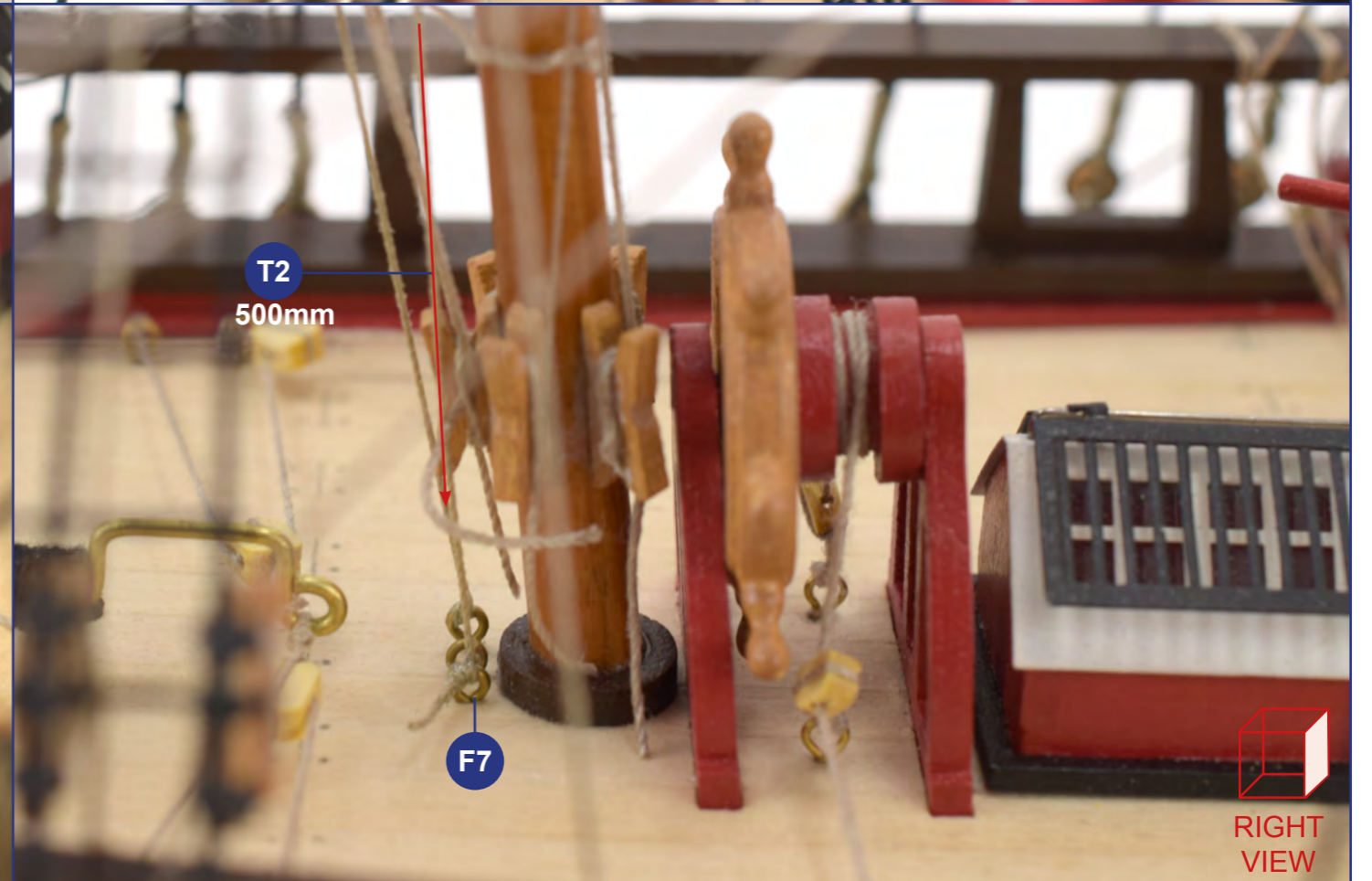
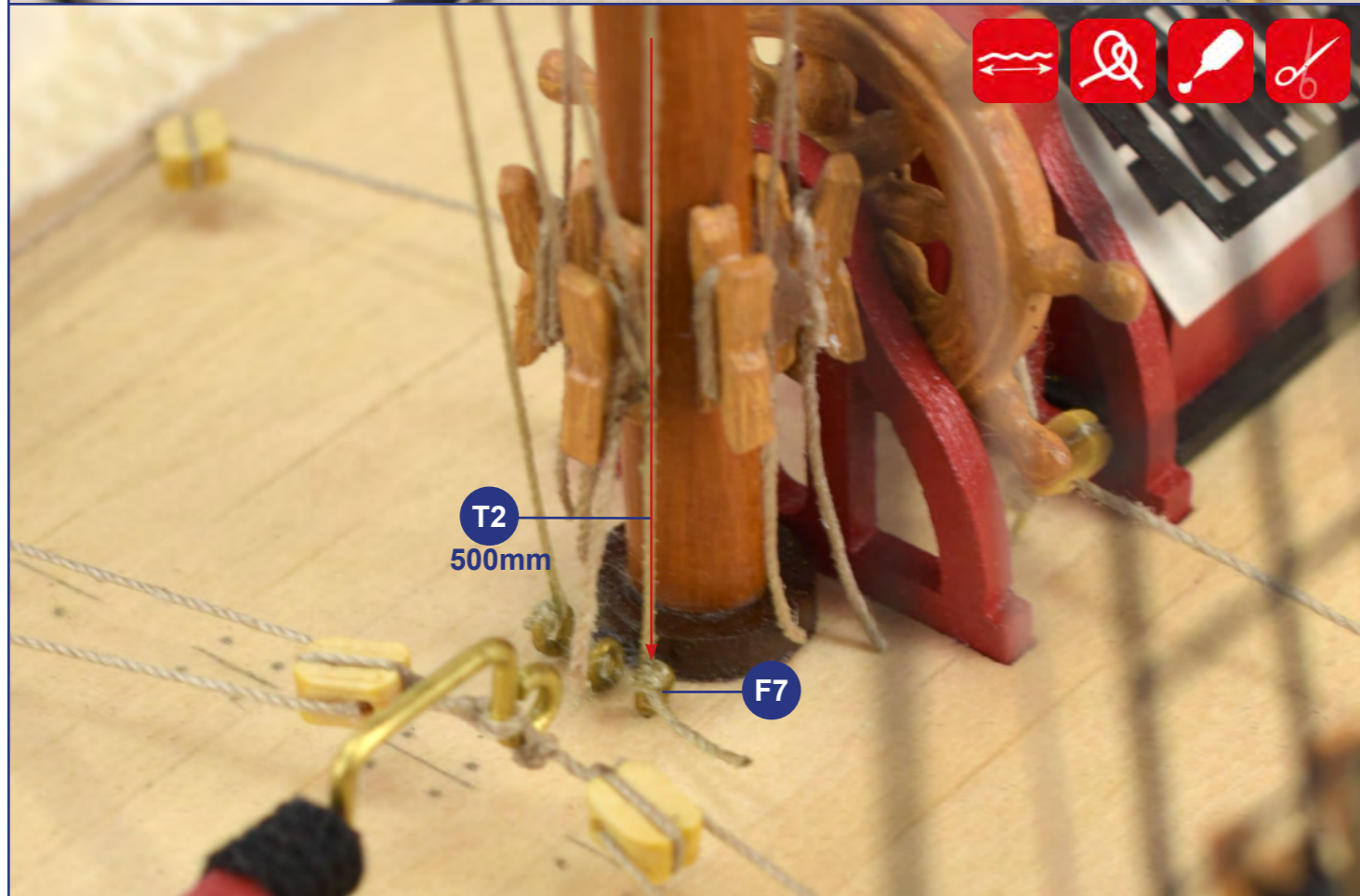

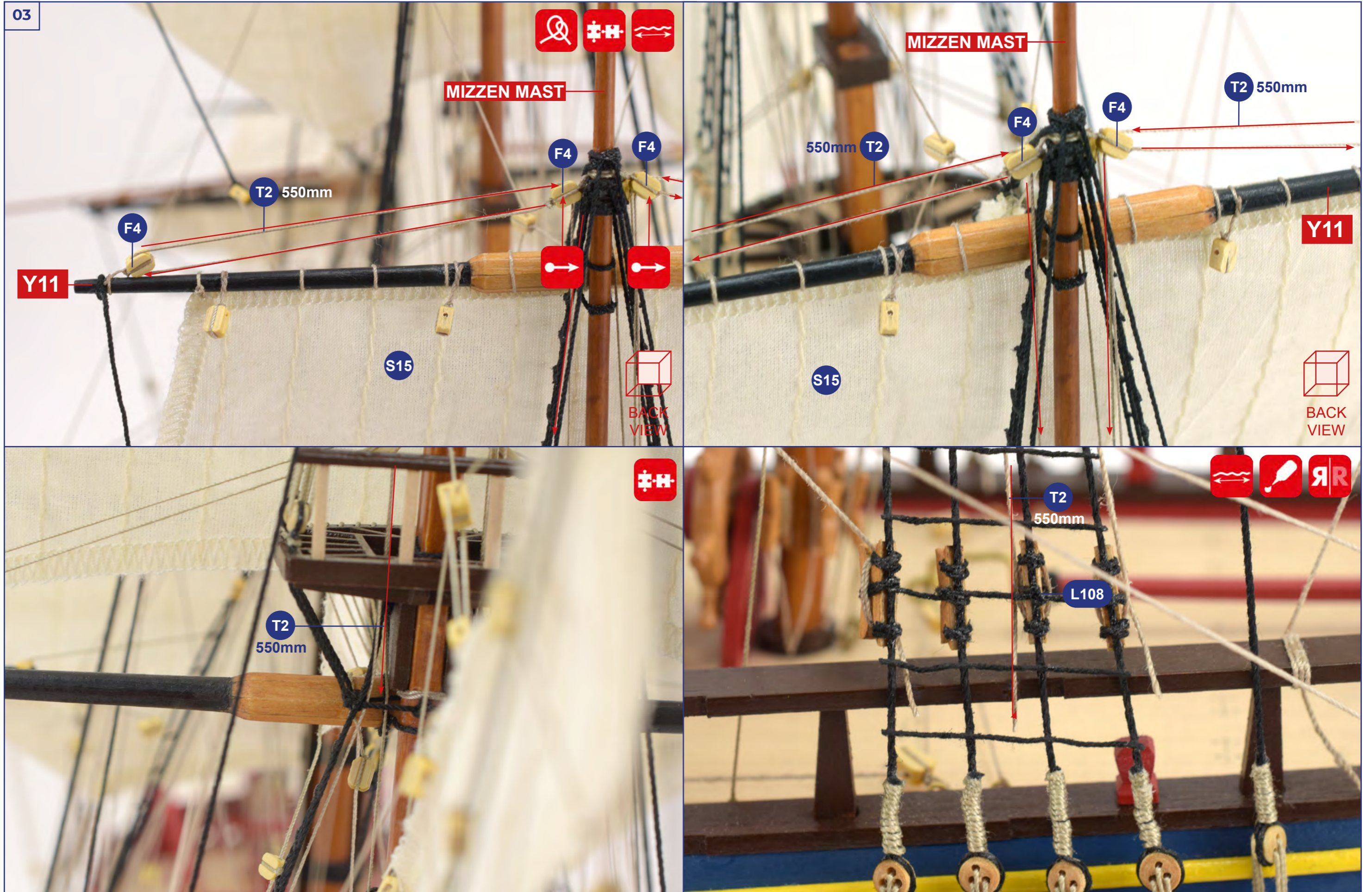

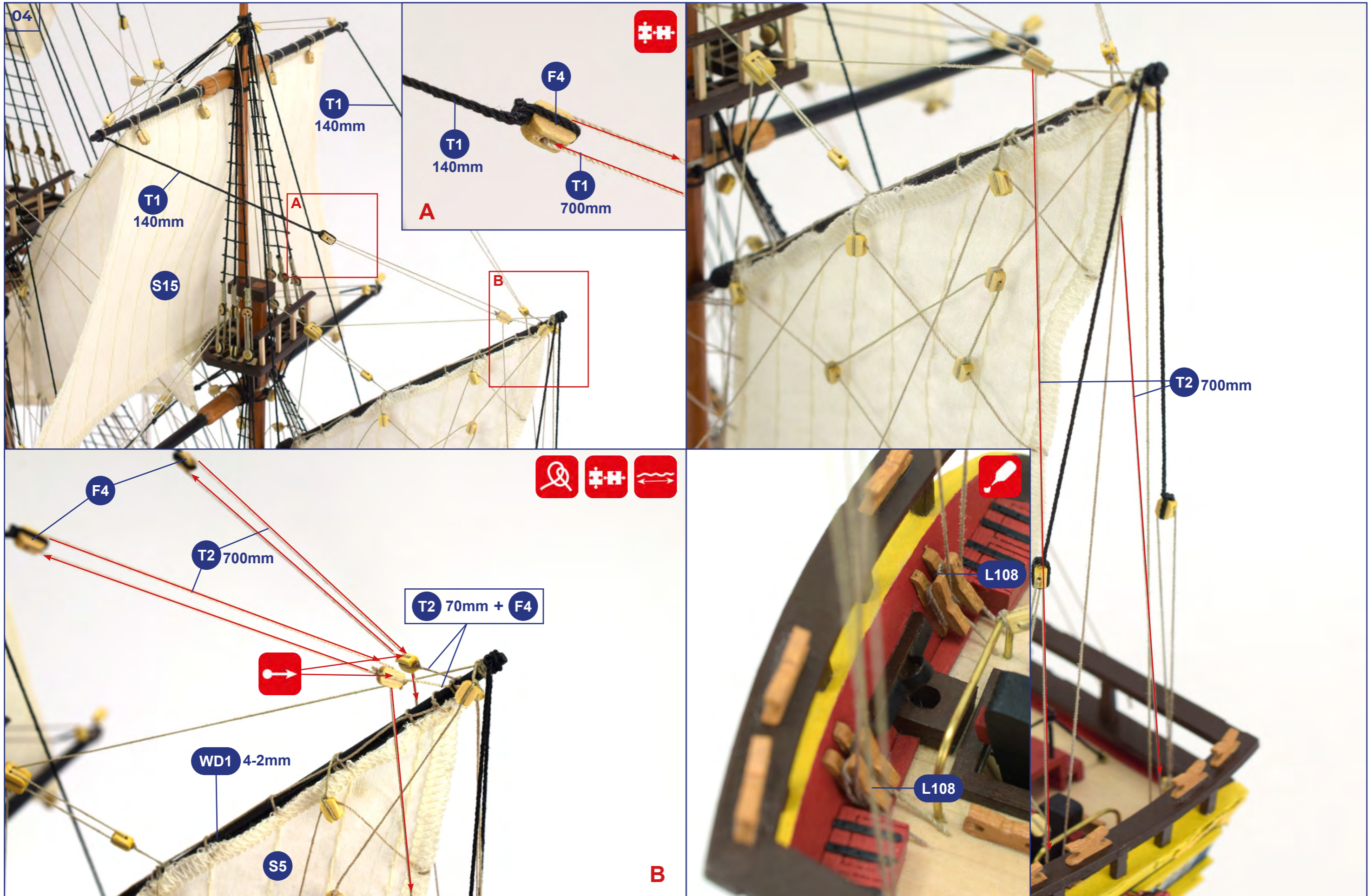

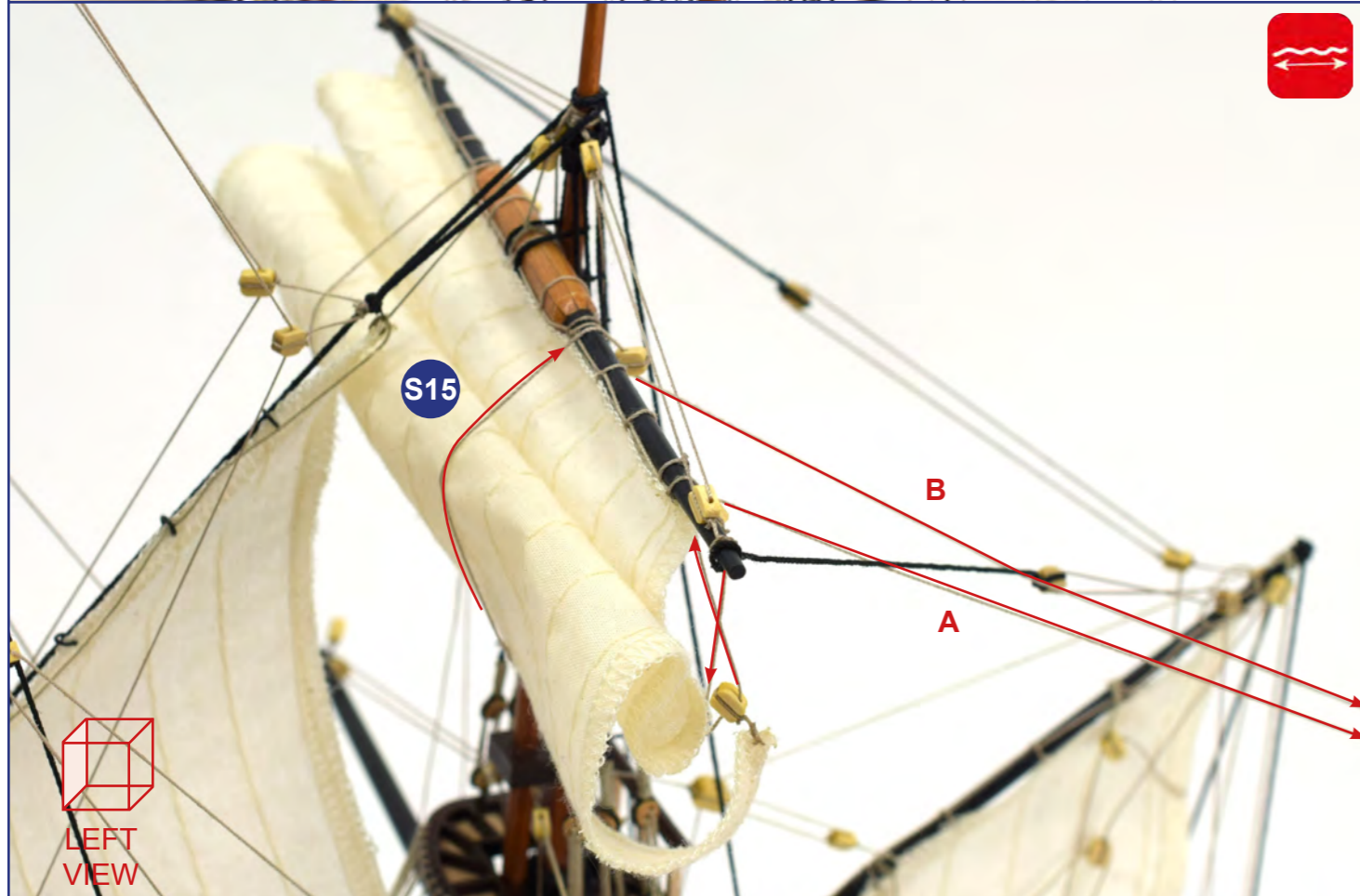
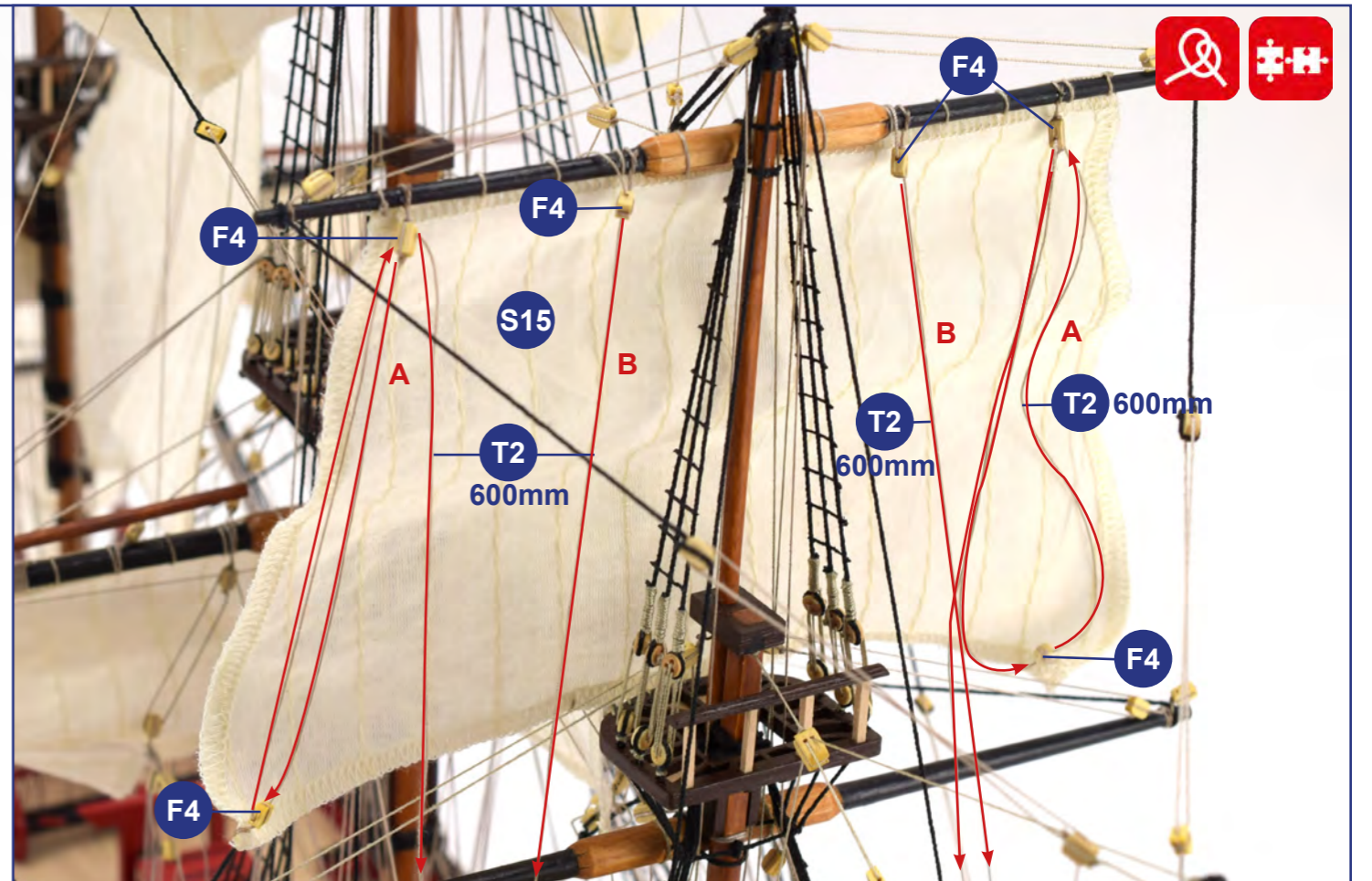
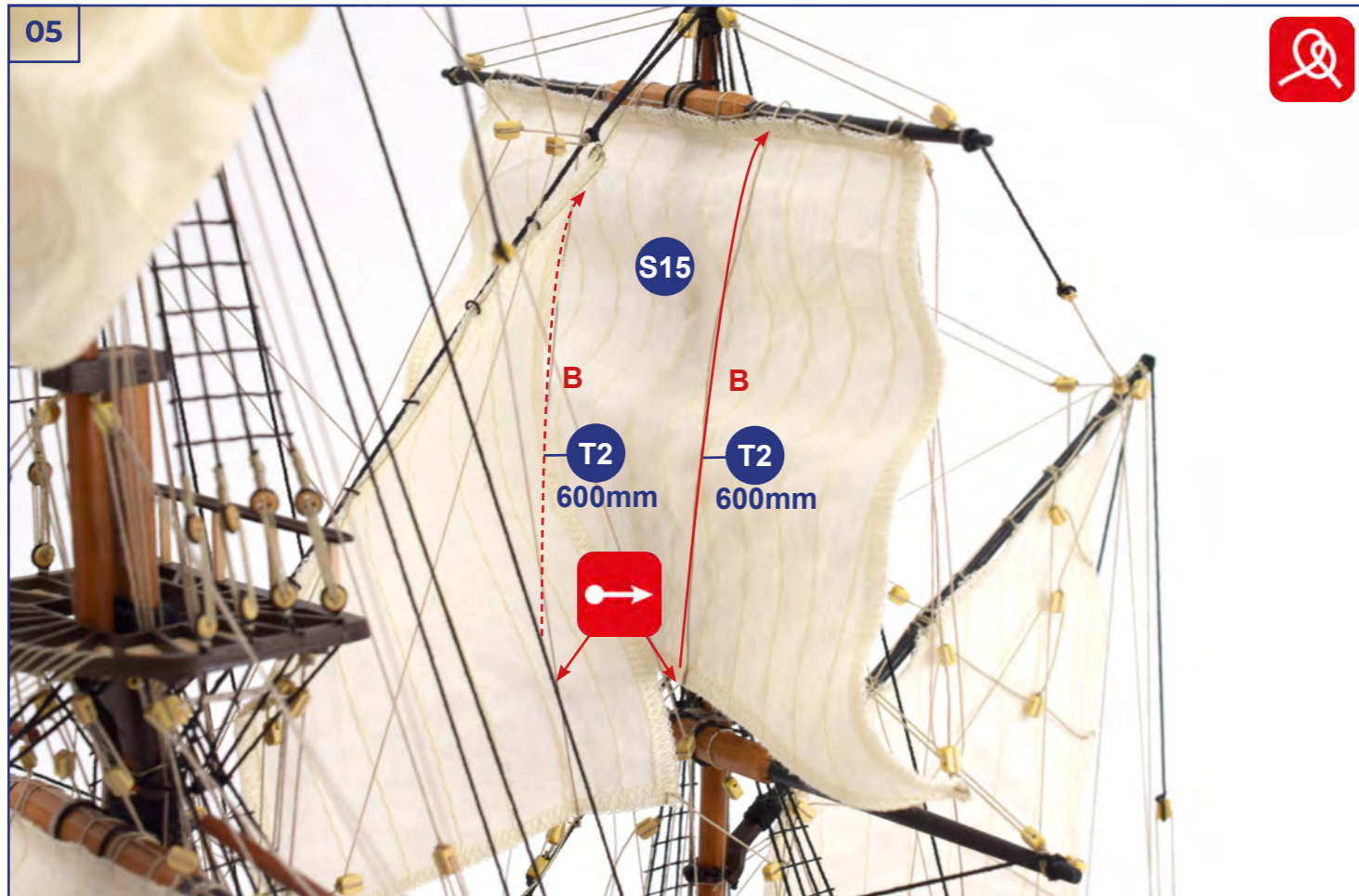

06

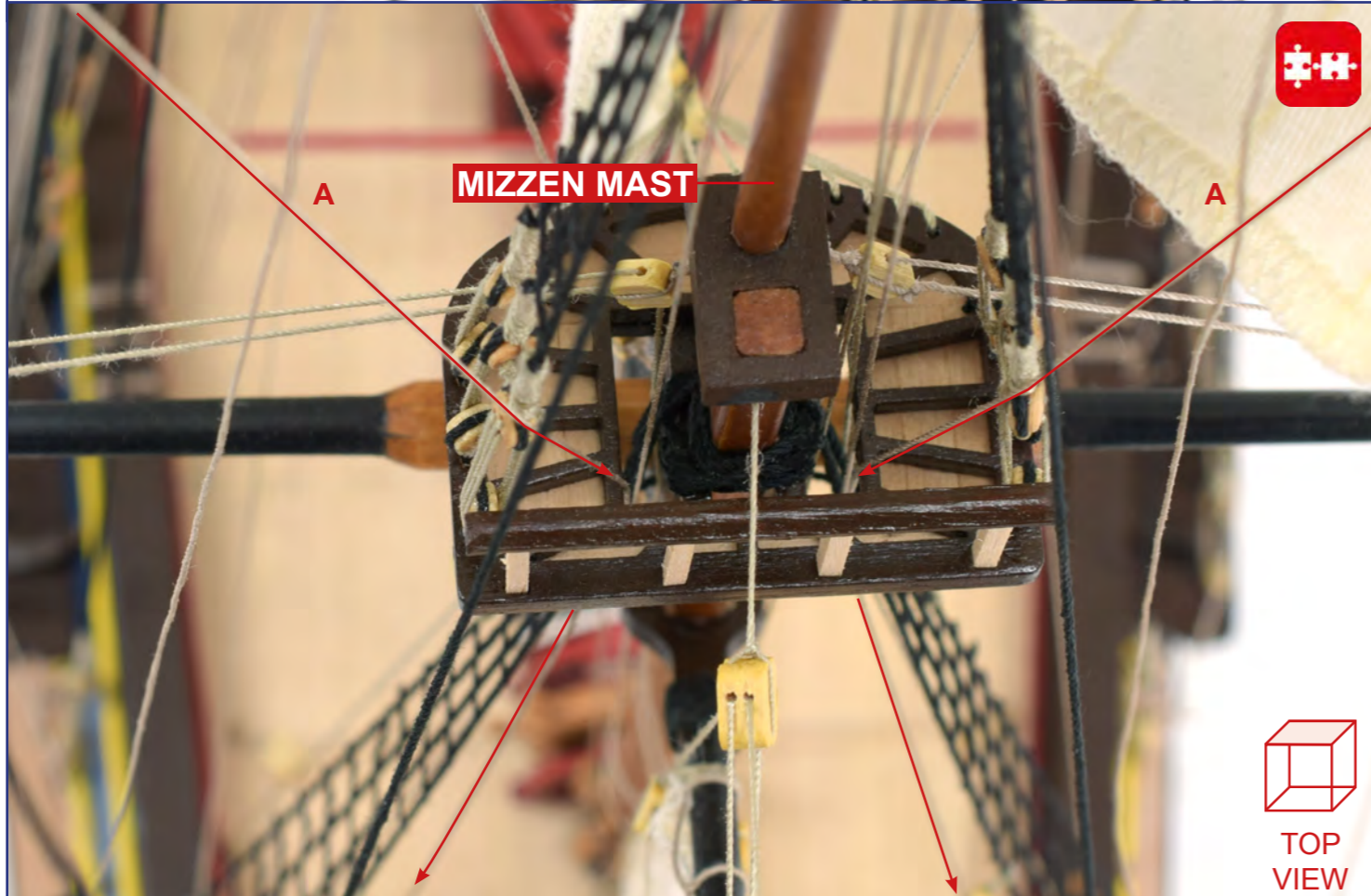
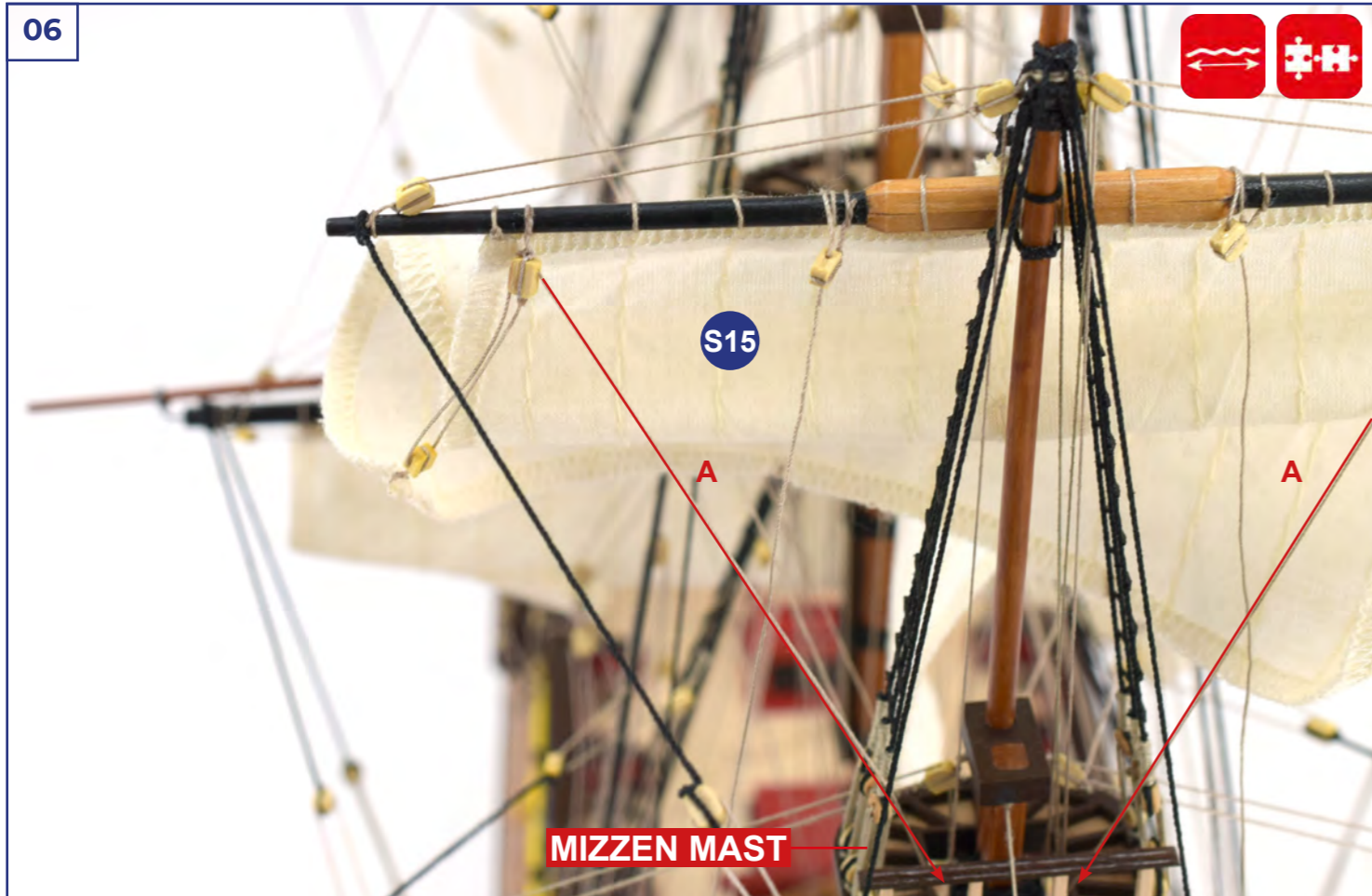

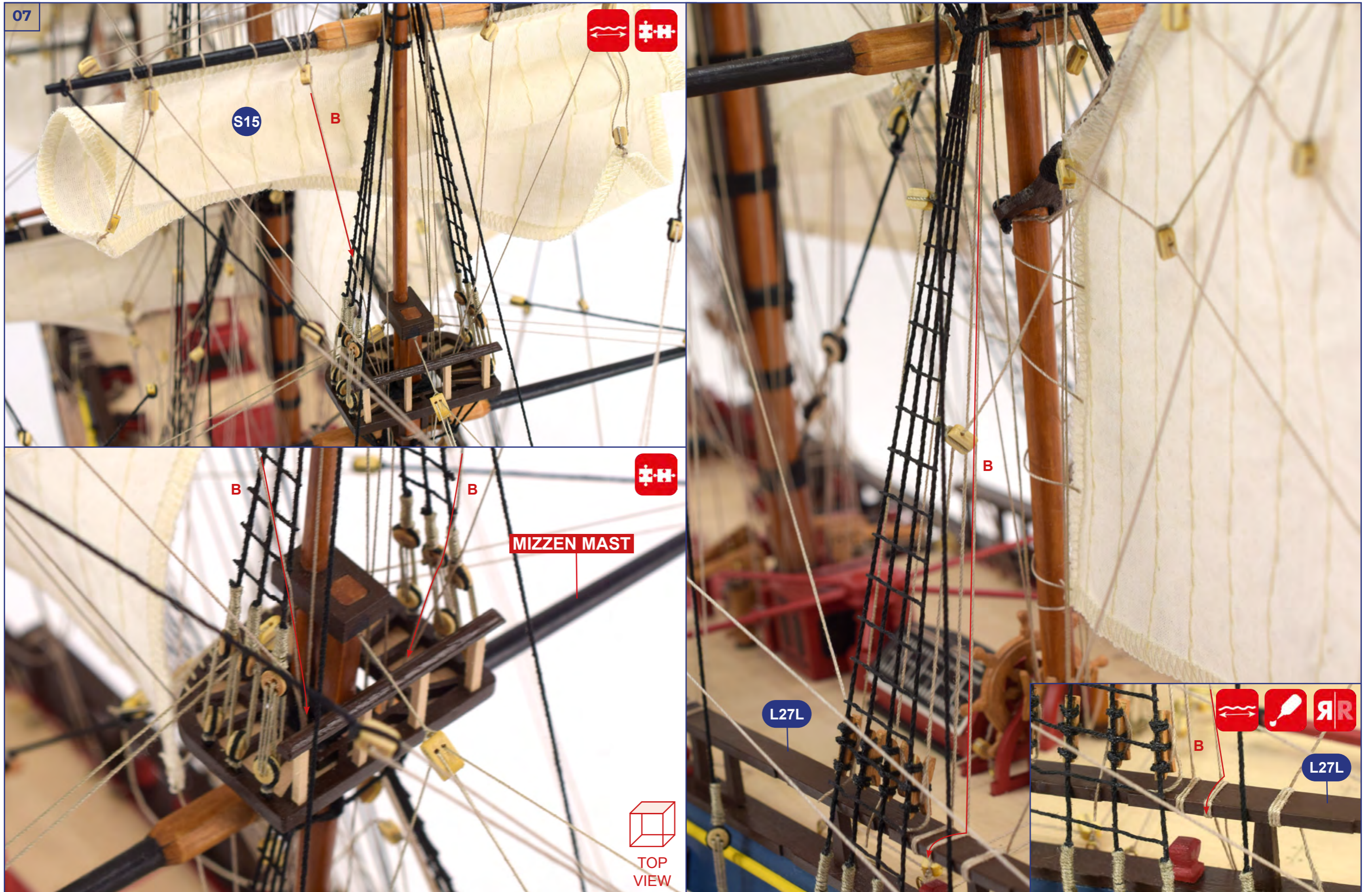

08

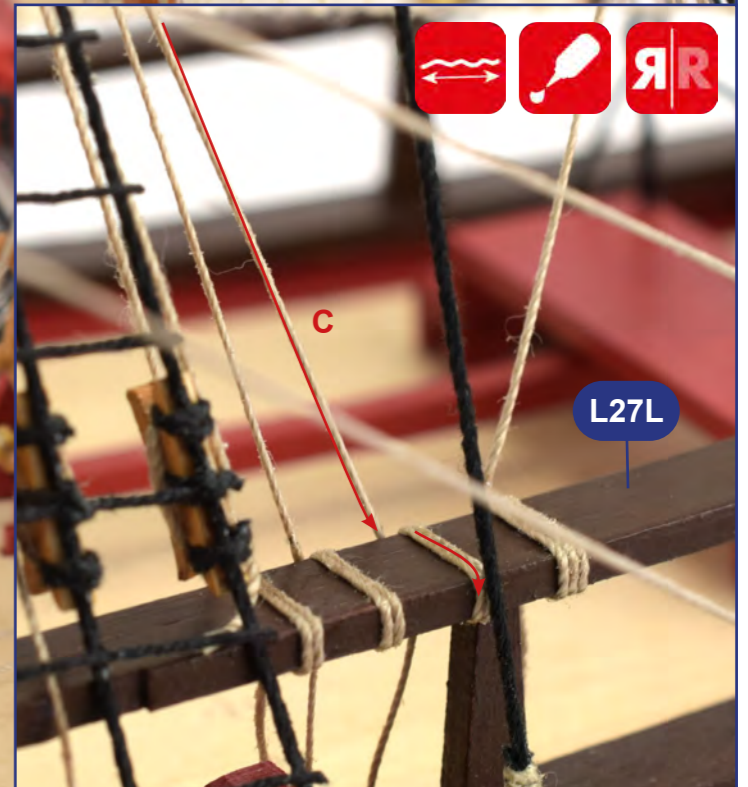
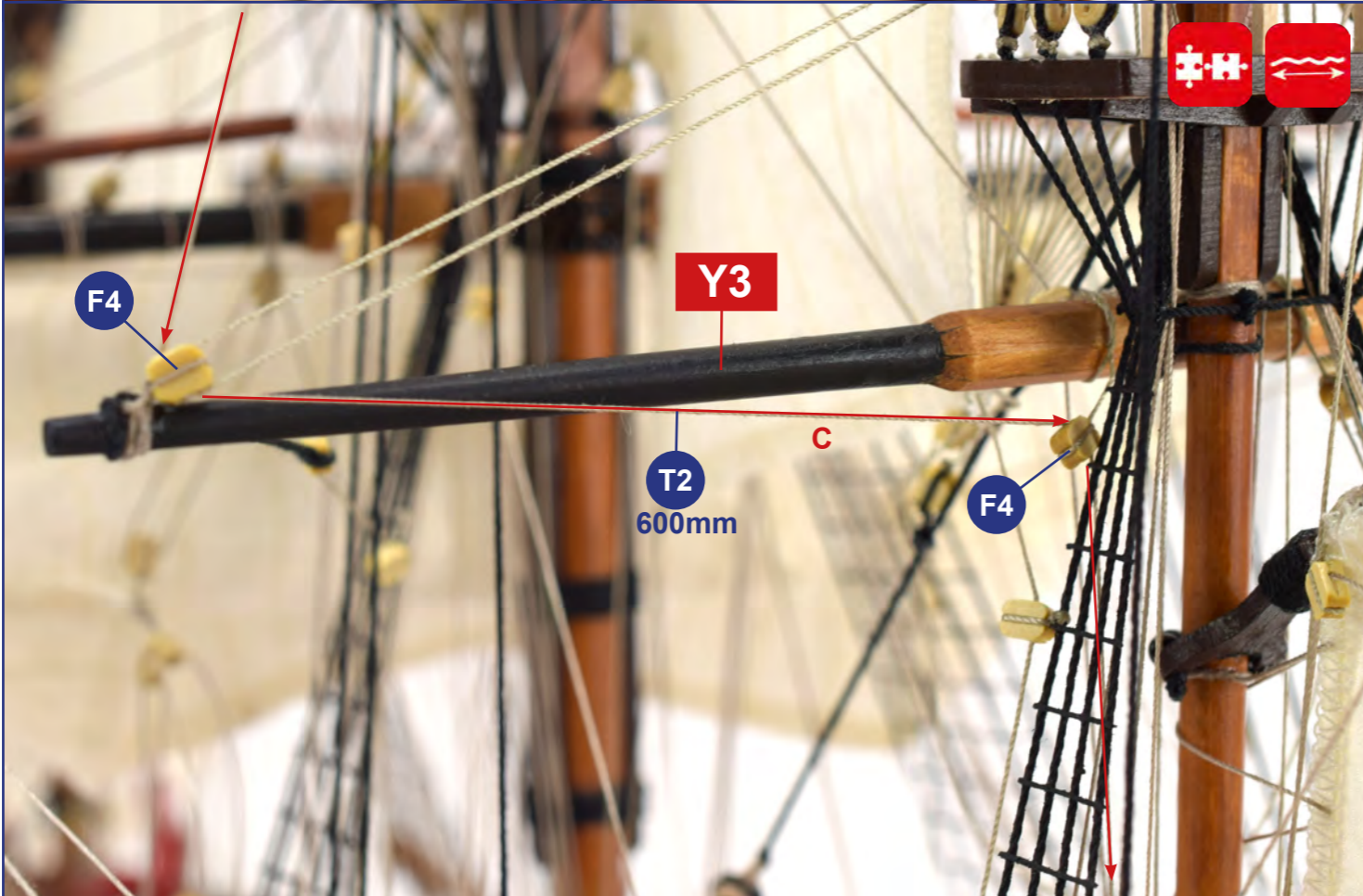
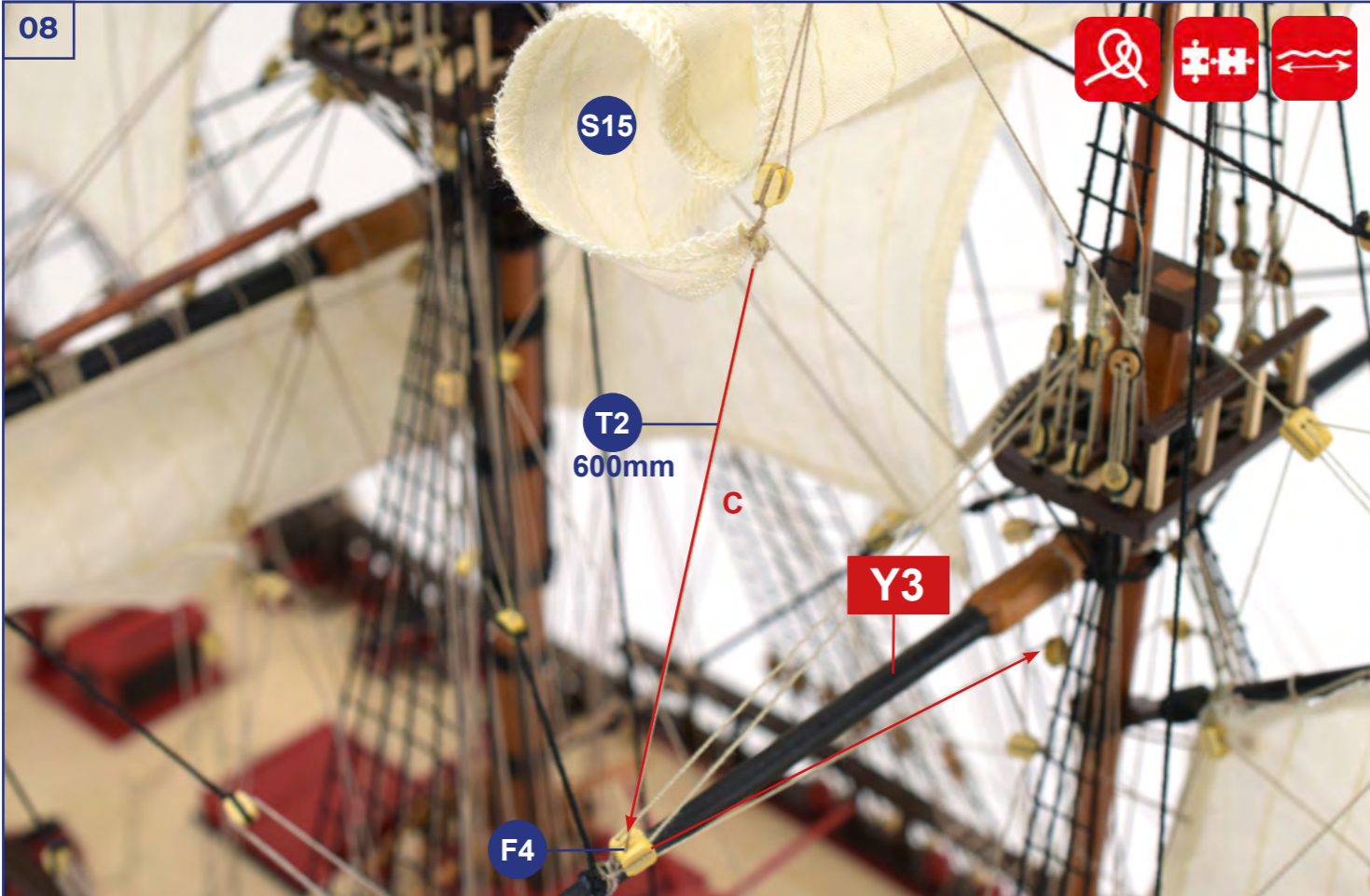

05

WS14

20mm x2

27mm x6

30mm x2

R

WS14

5

WS14

R

06

F34

F34

6

F34

F34 x10

R

07

F34

WS14

WS14

Ø1,5mm

WS14

R

x10

WS14 30mm

WS14 20mm

WS14 27mm

F34

F34

F34

F34

F34

F34

F34

F34

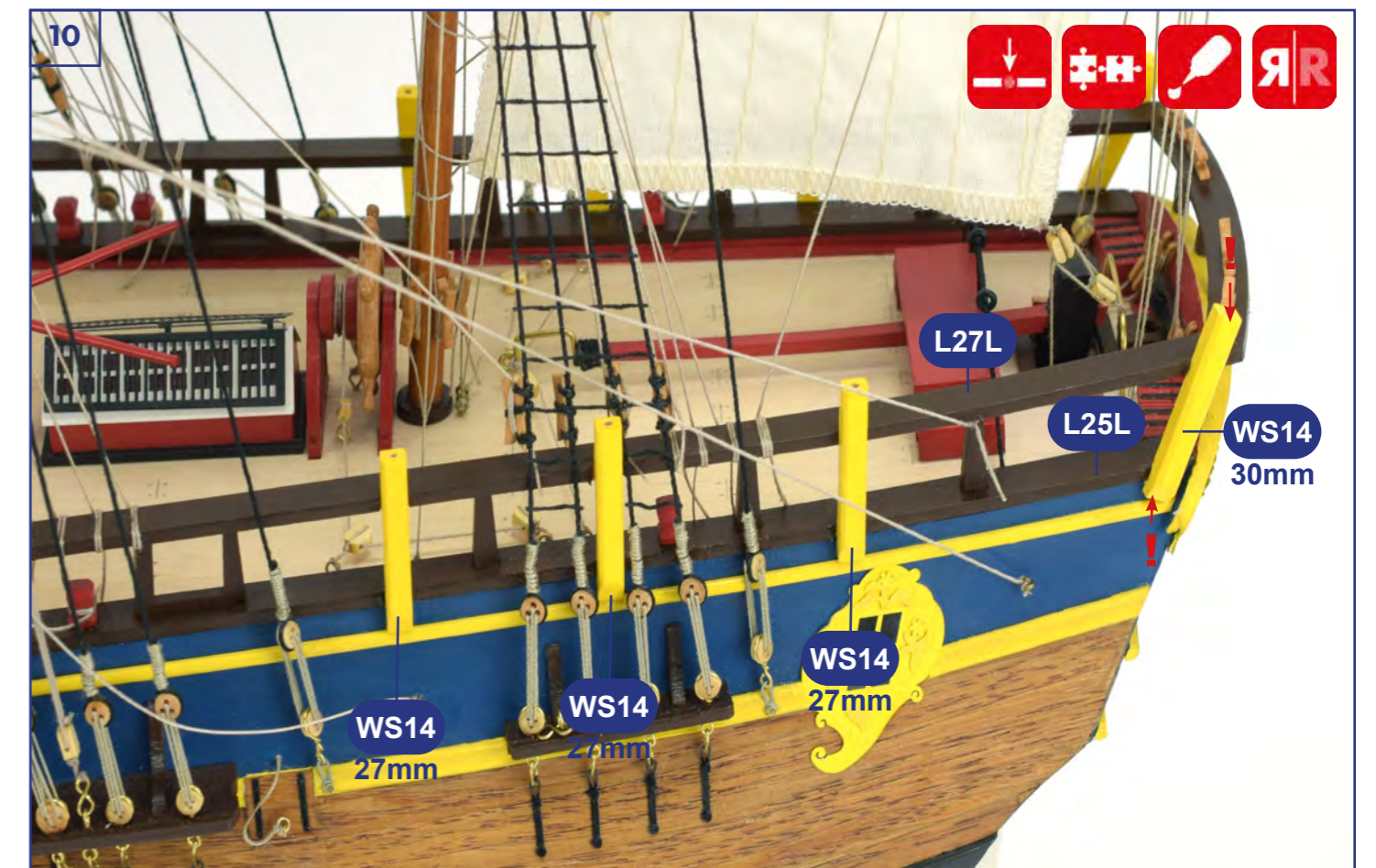
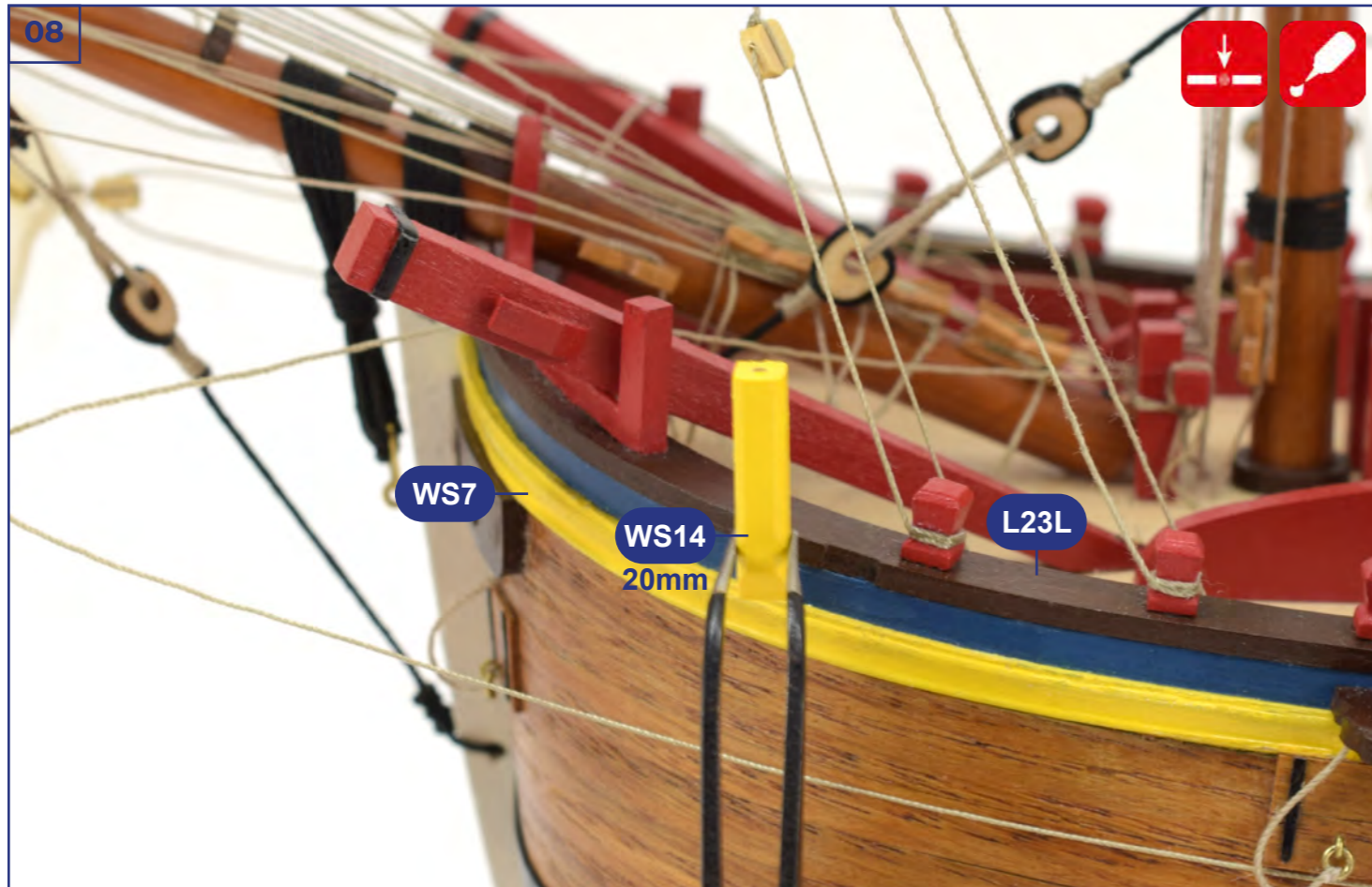

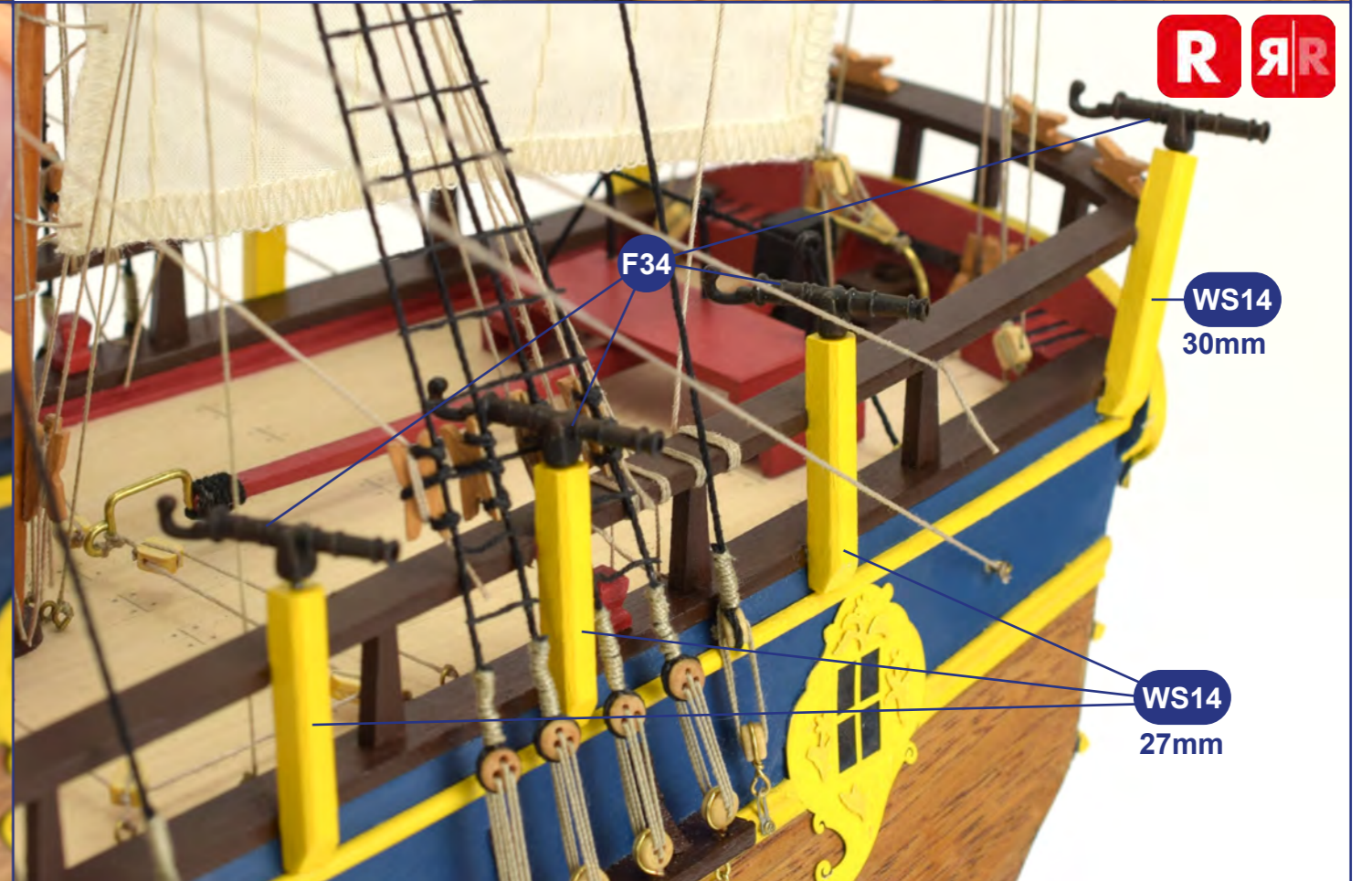
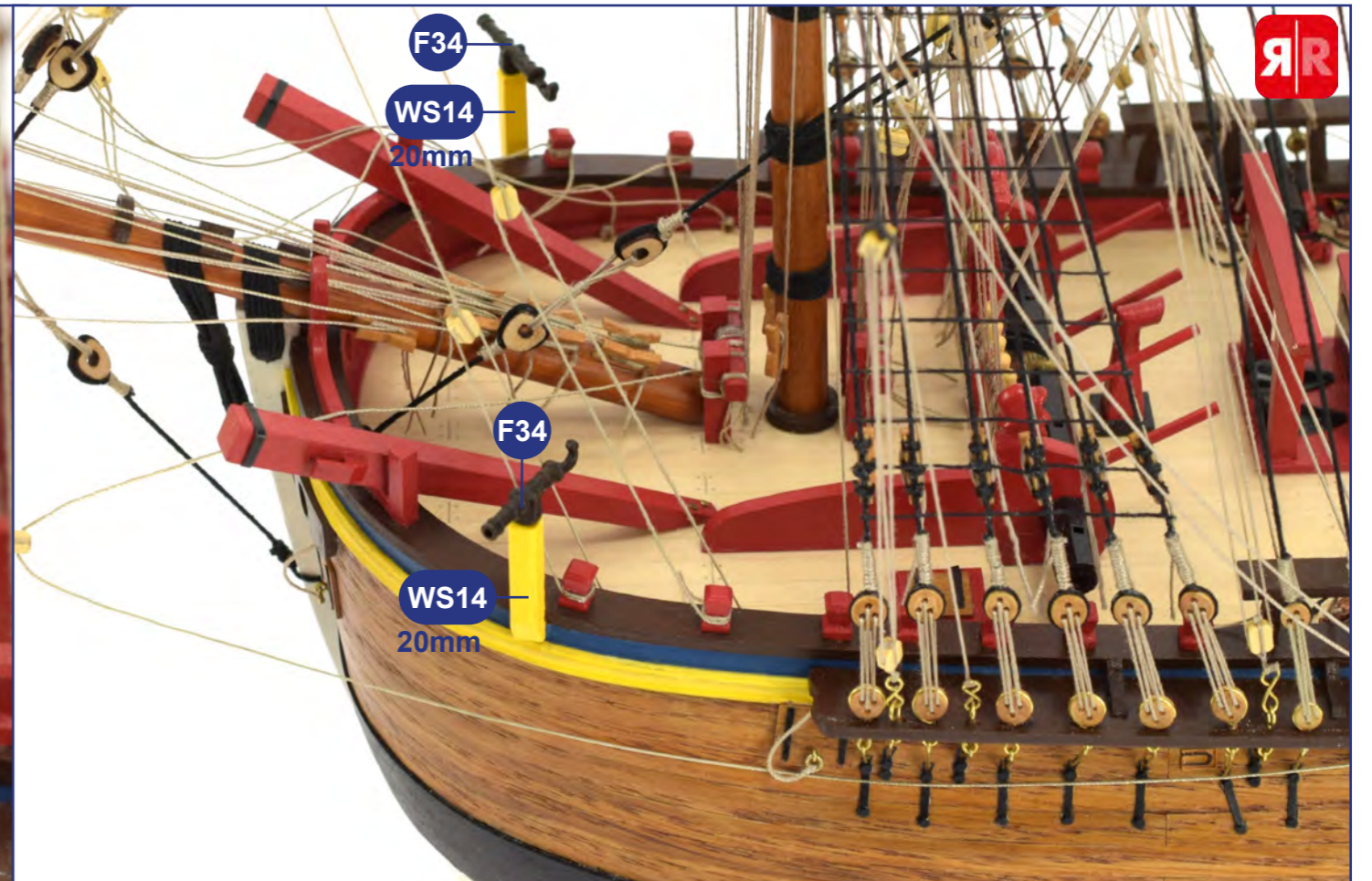

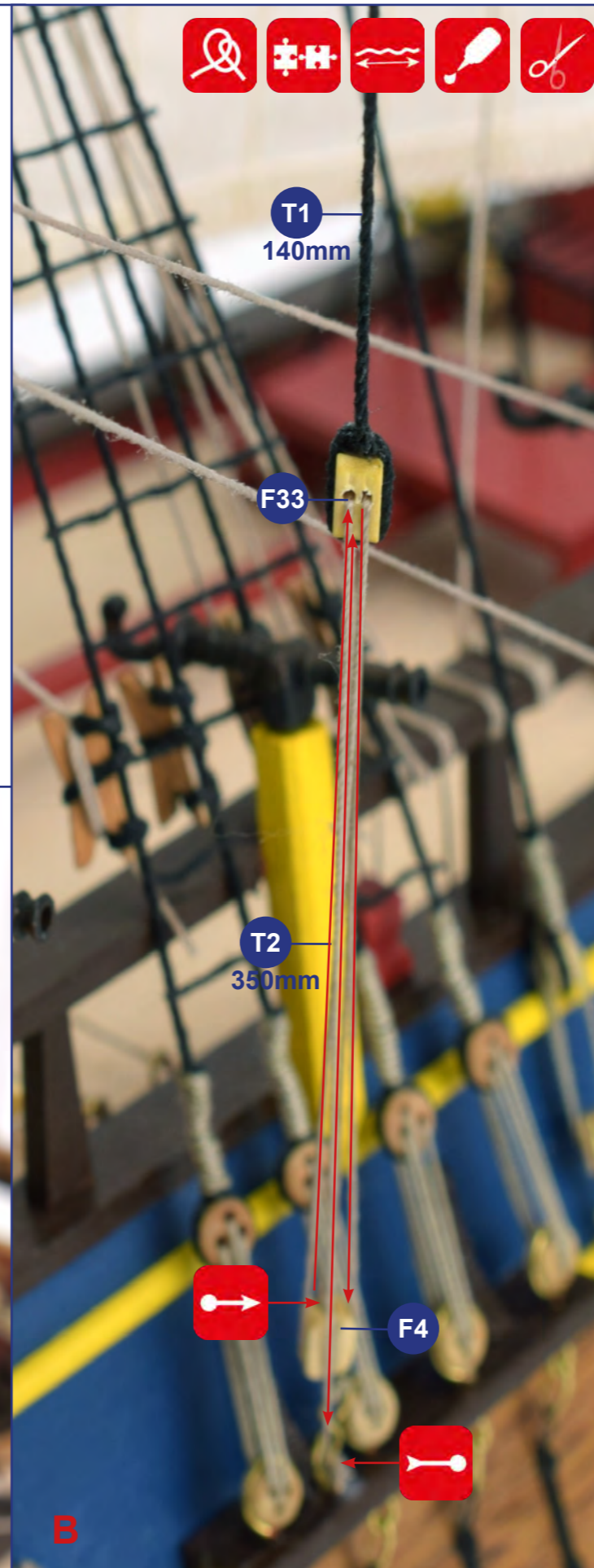
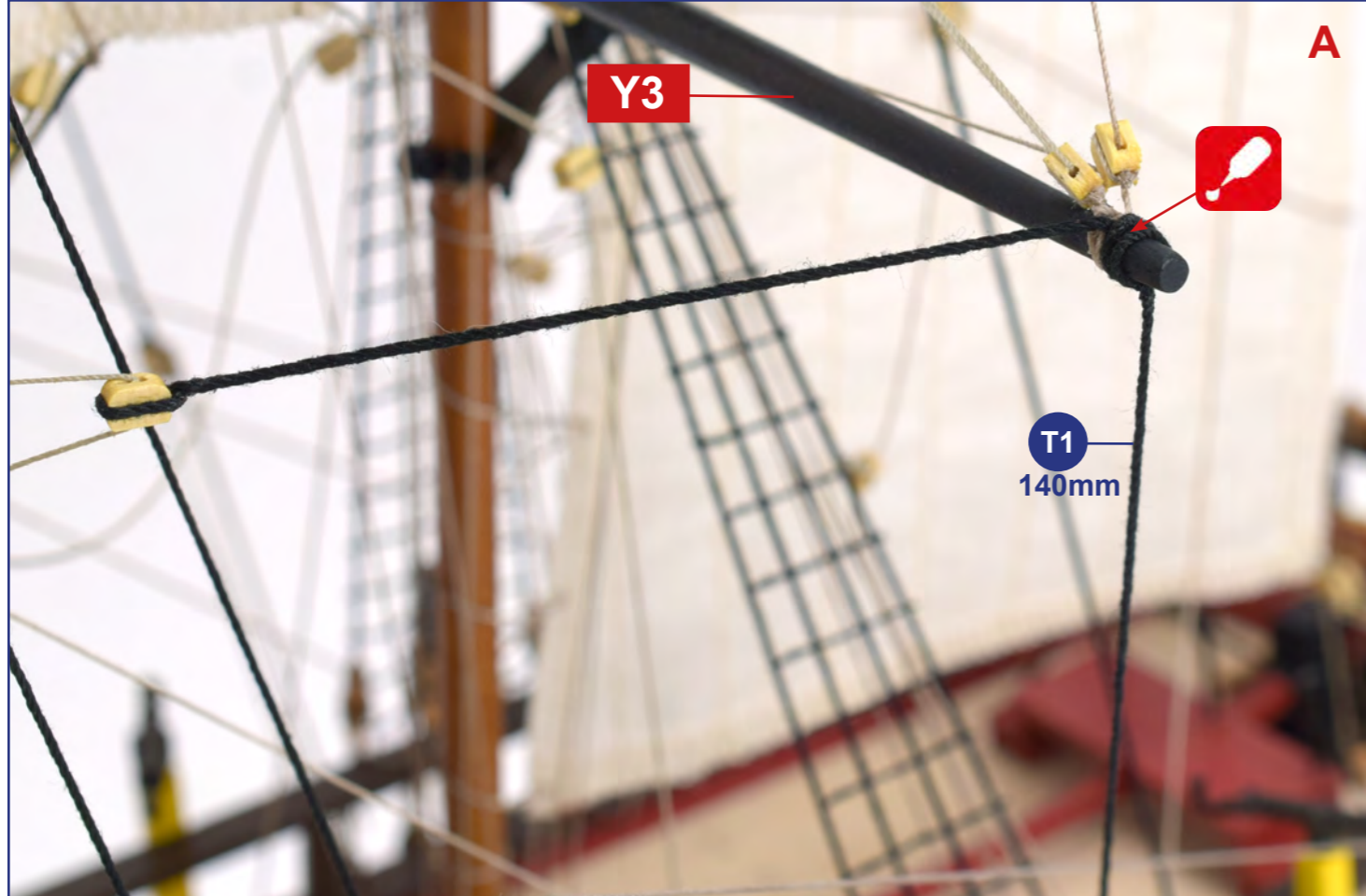
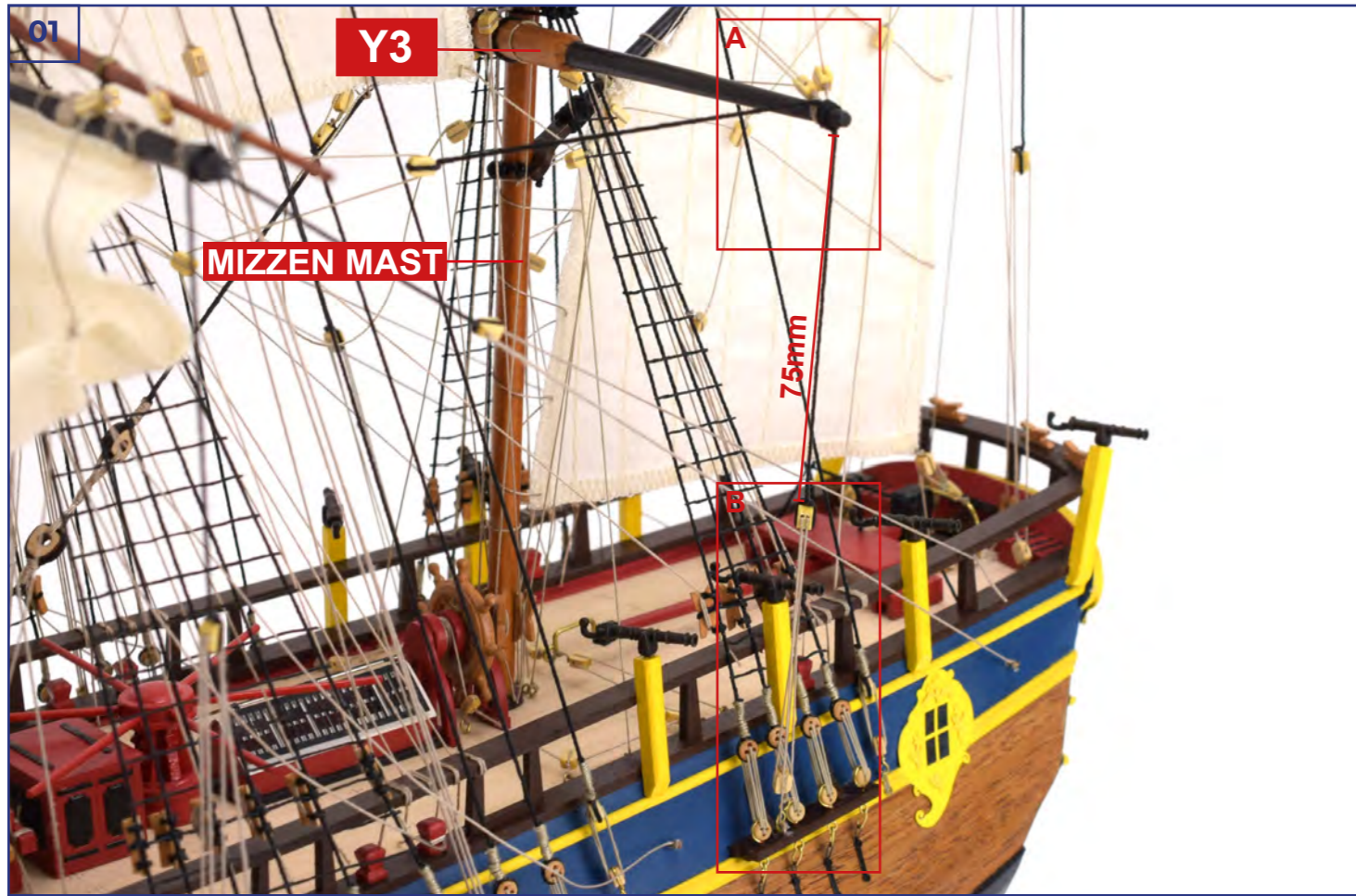

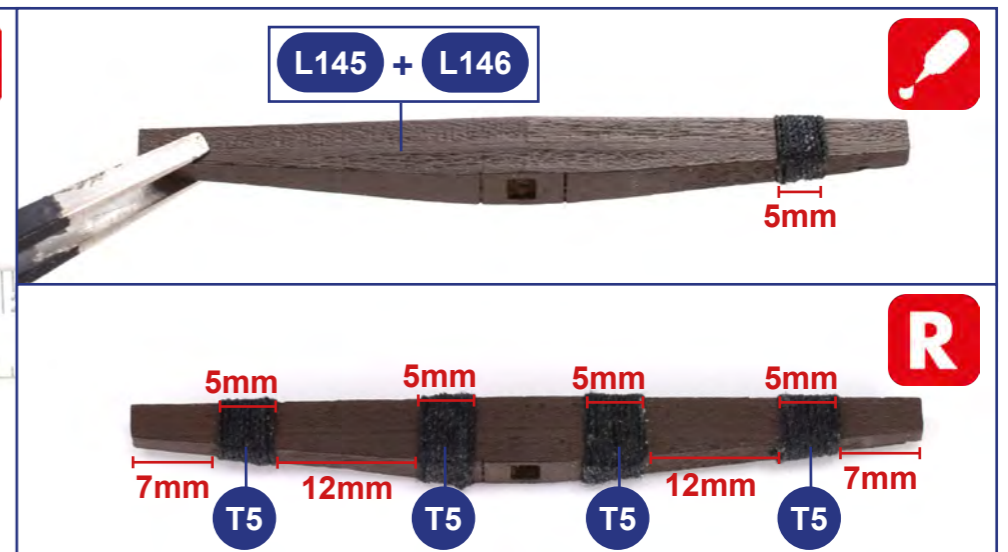
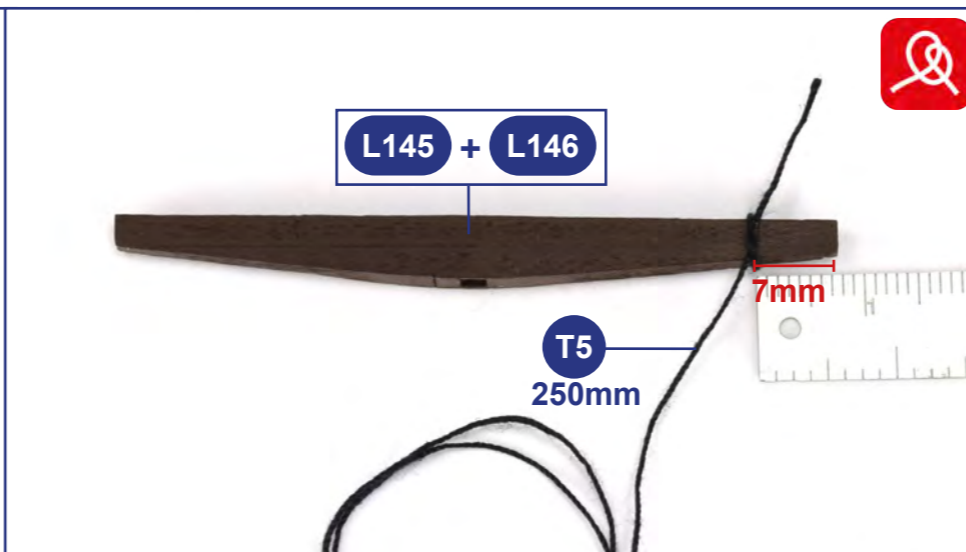
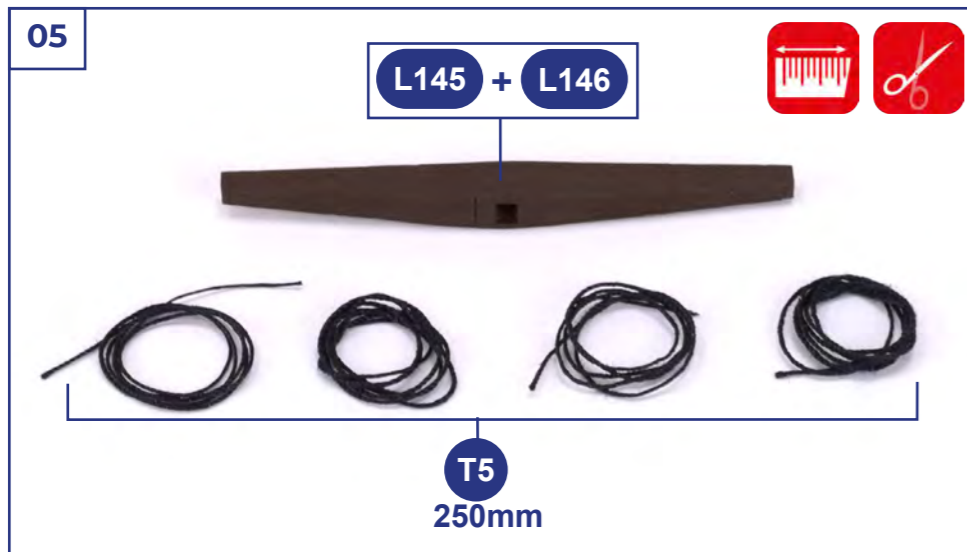
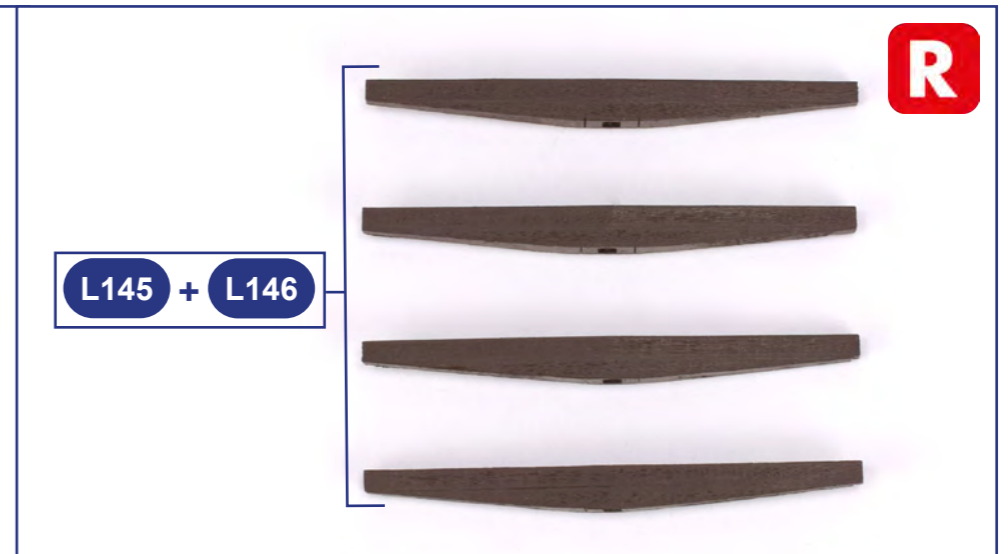
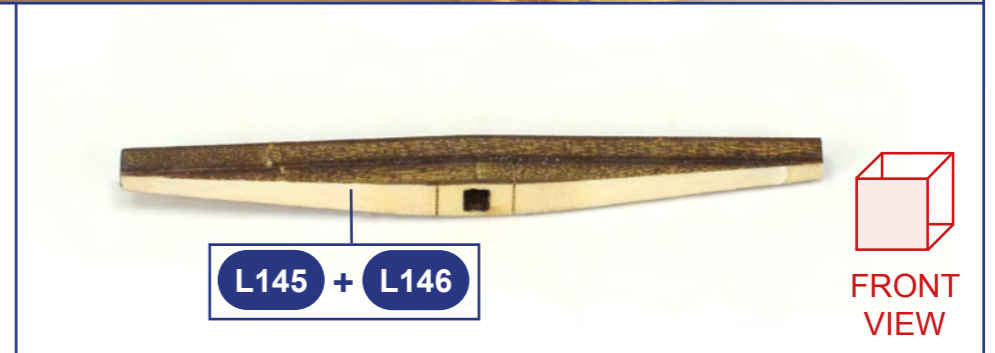
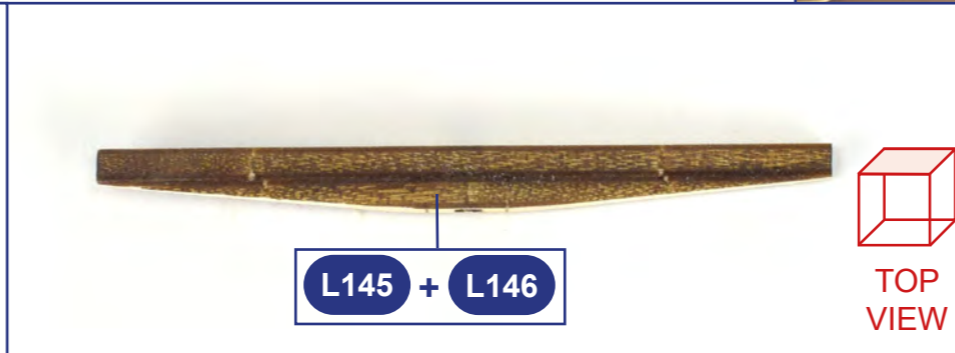
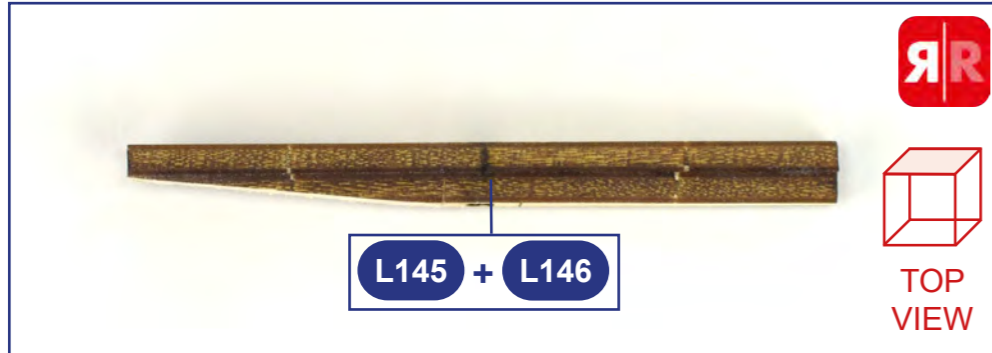
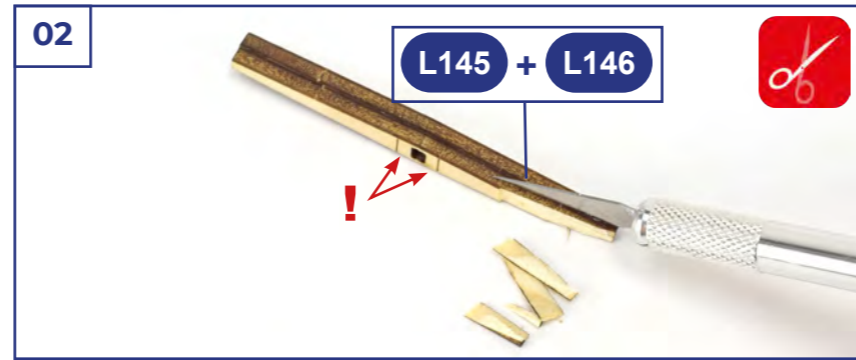

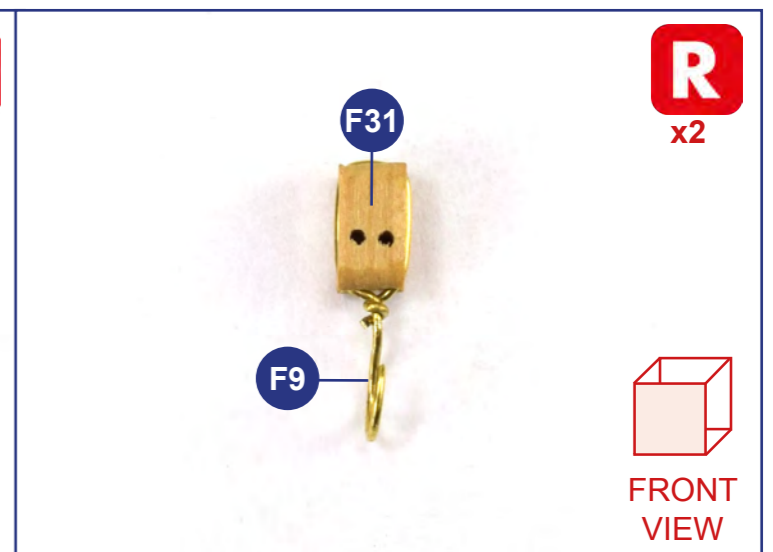
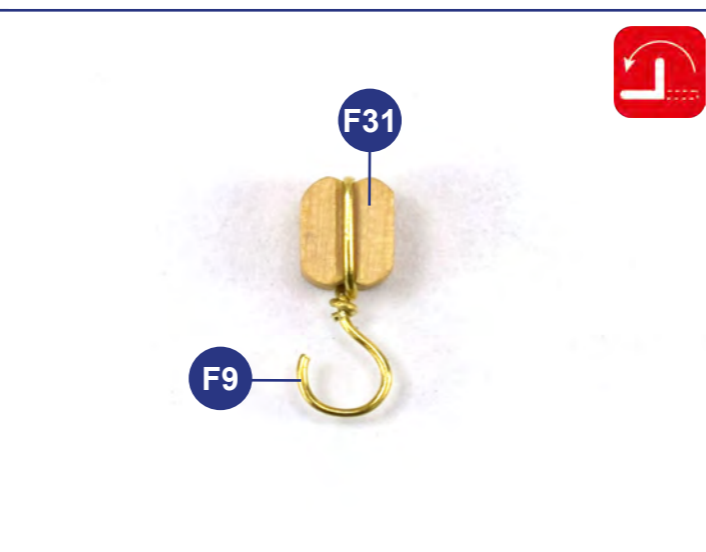
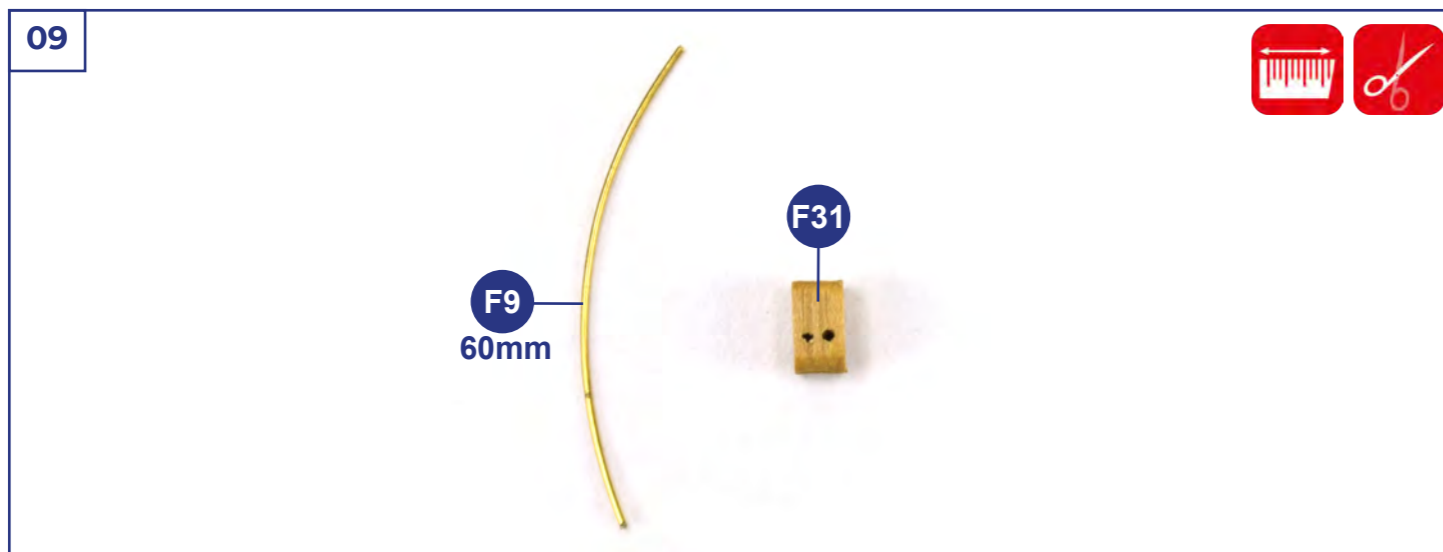
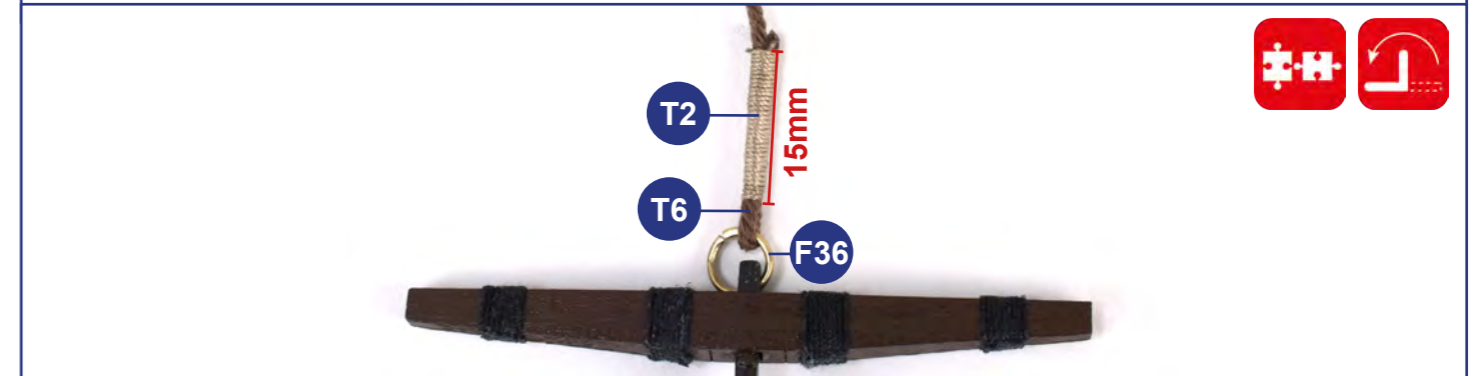
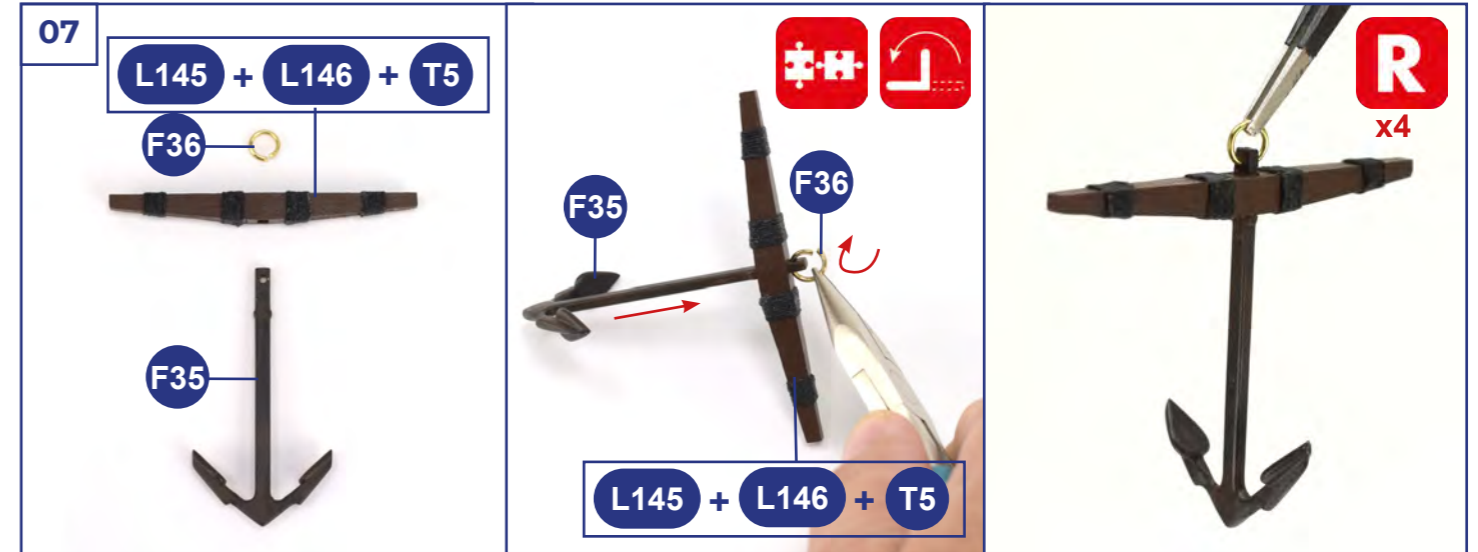

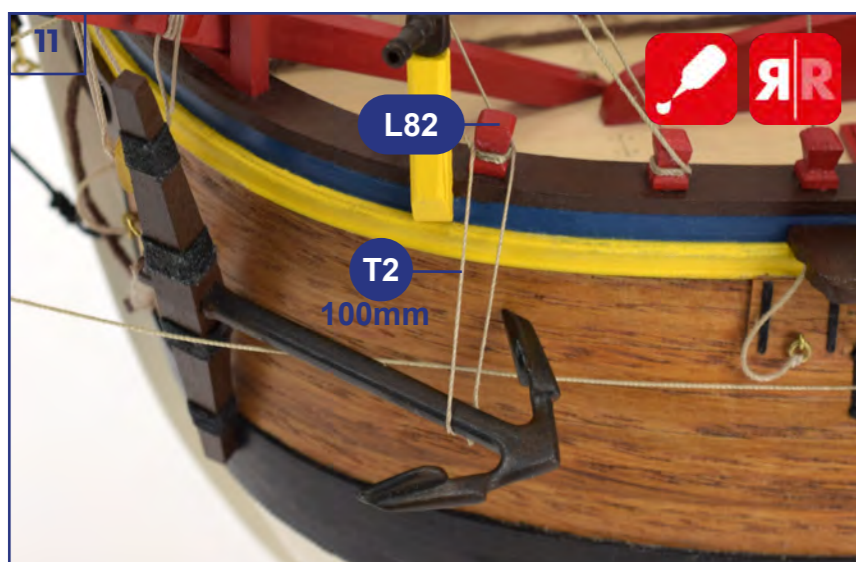
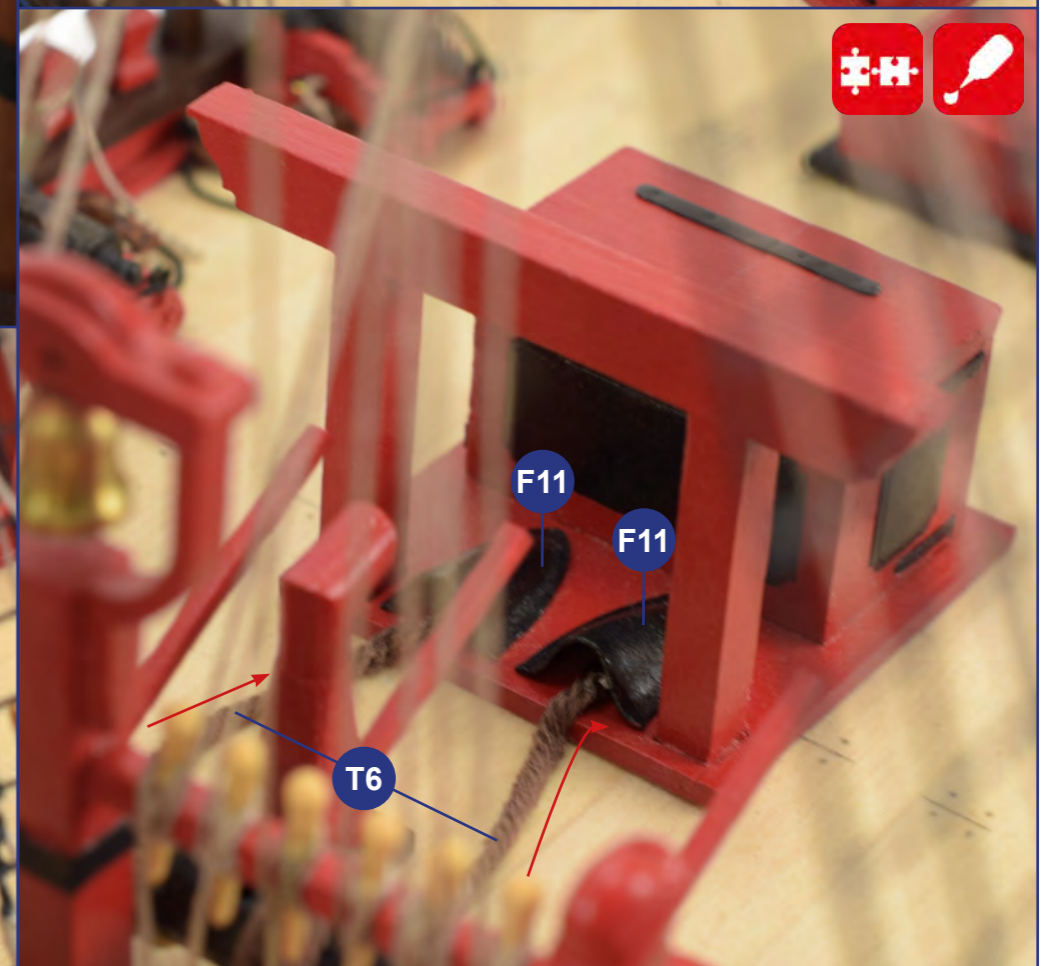
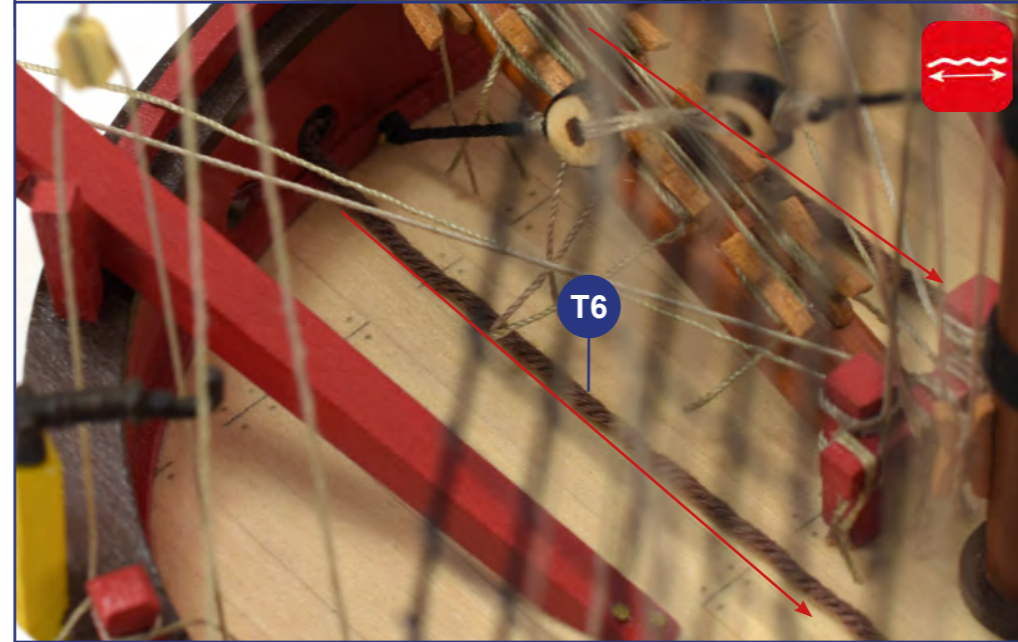
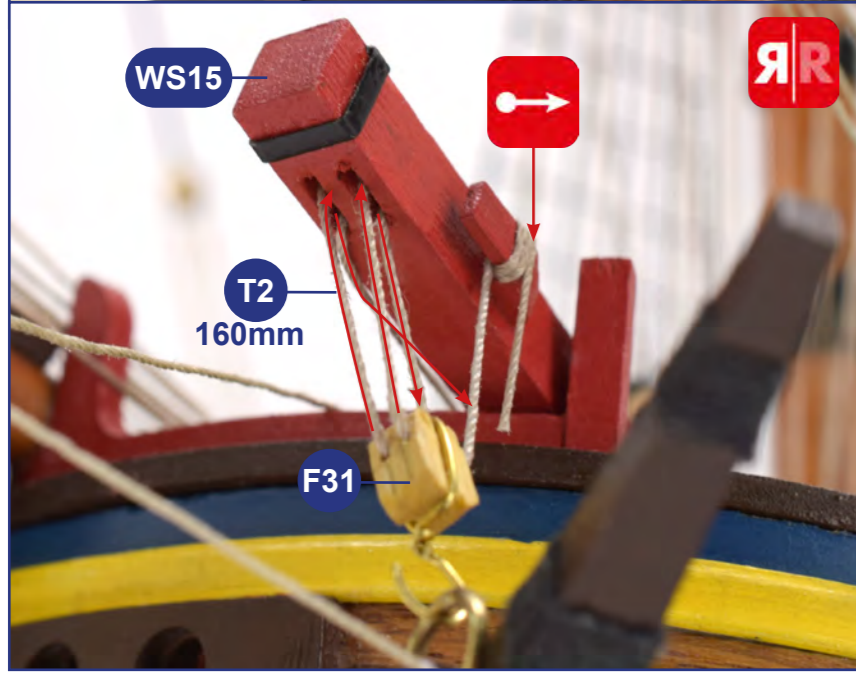
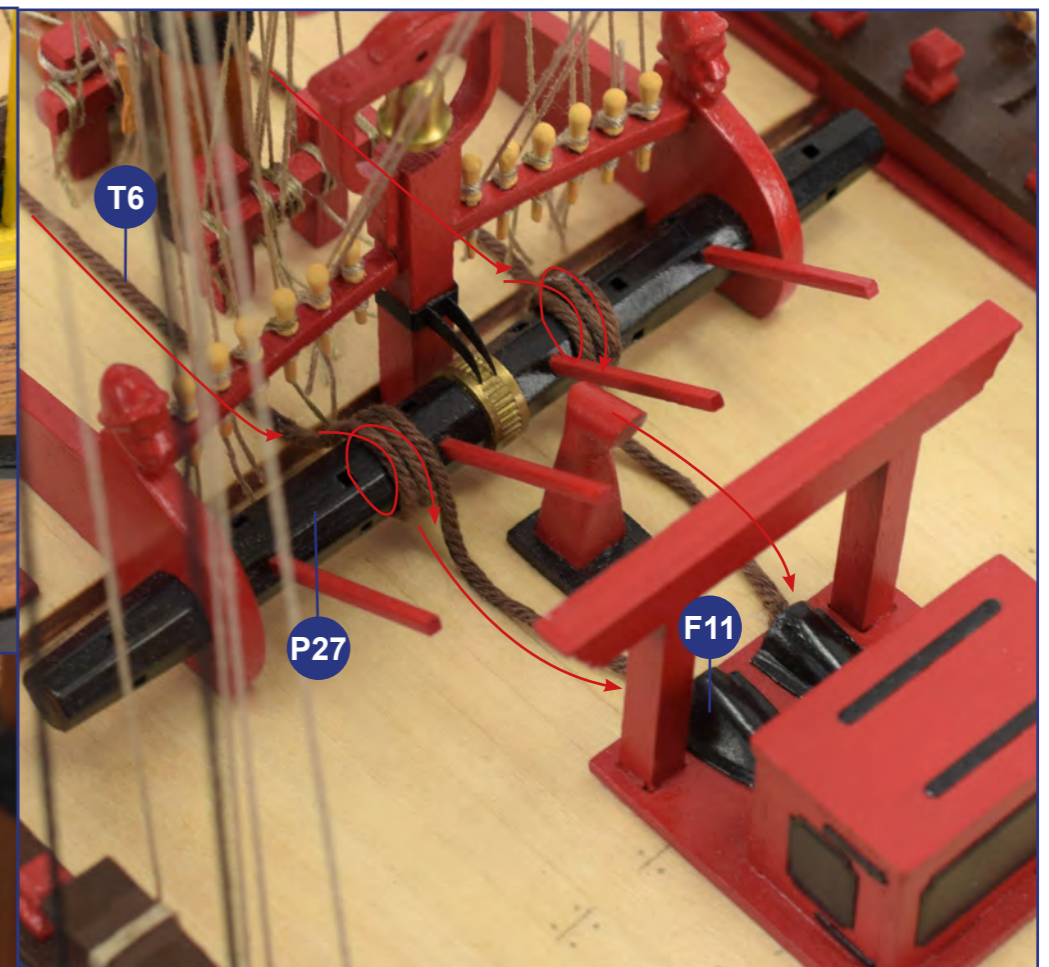
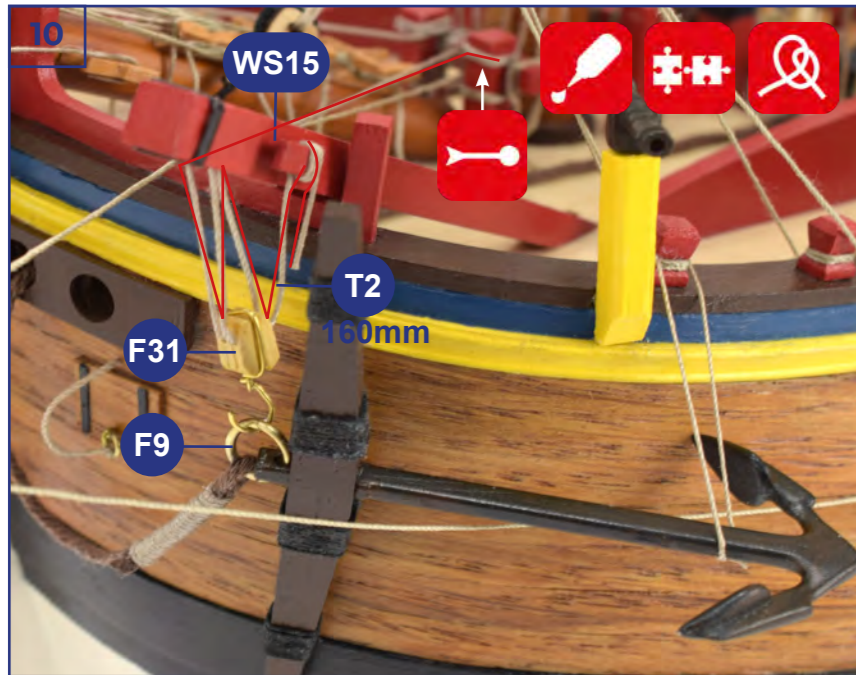

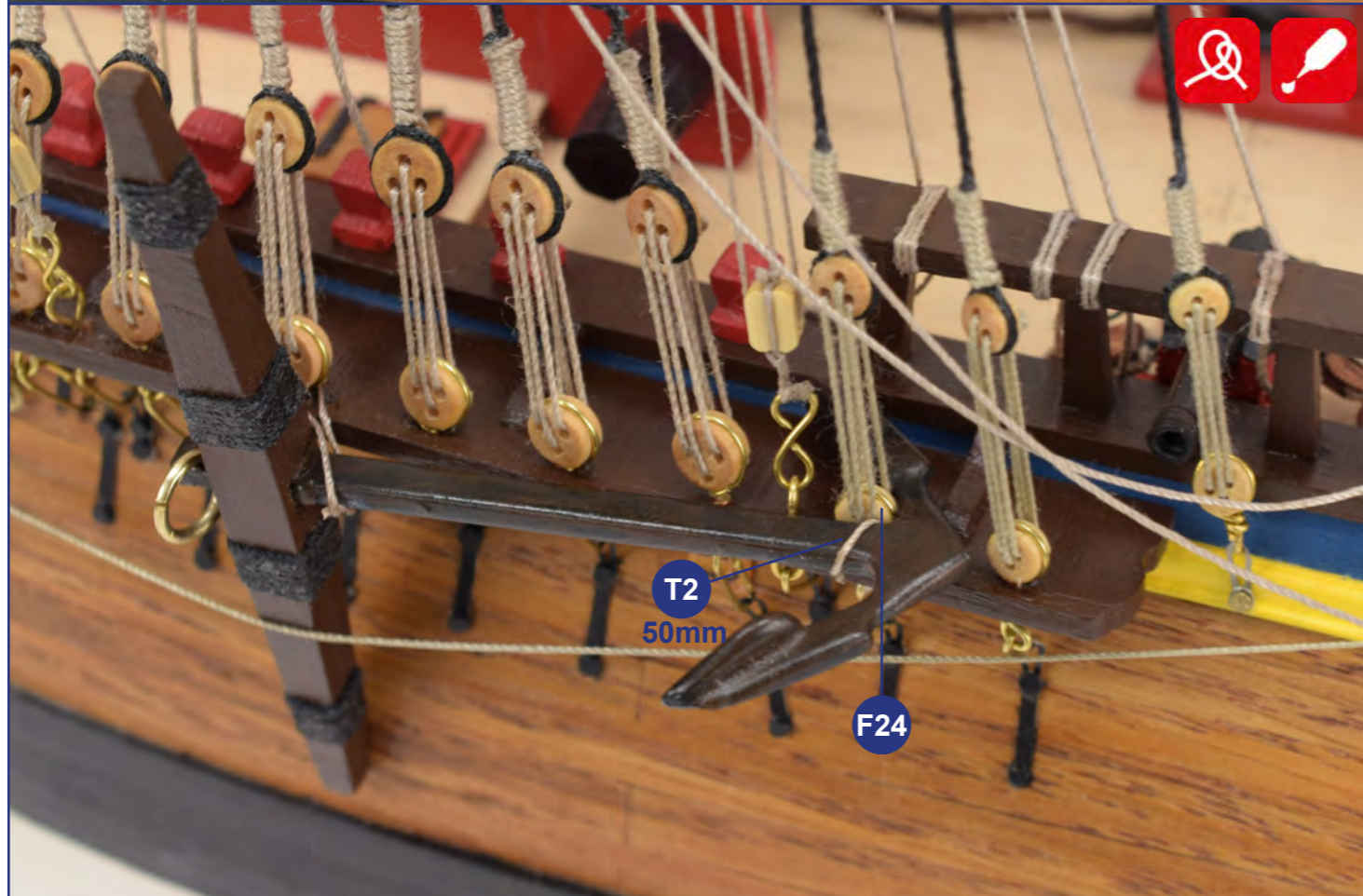
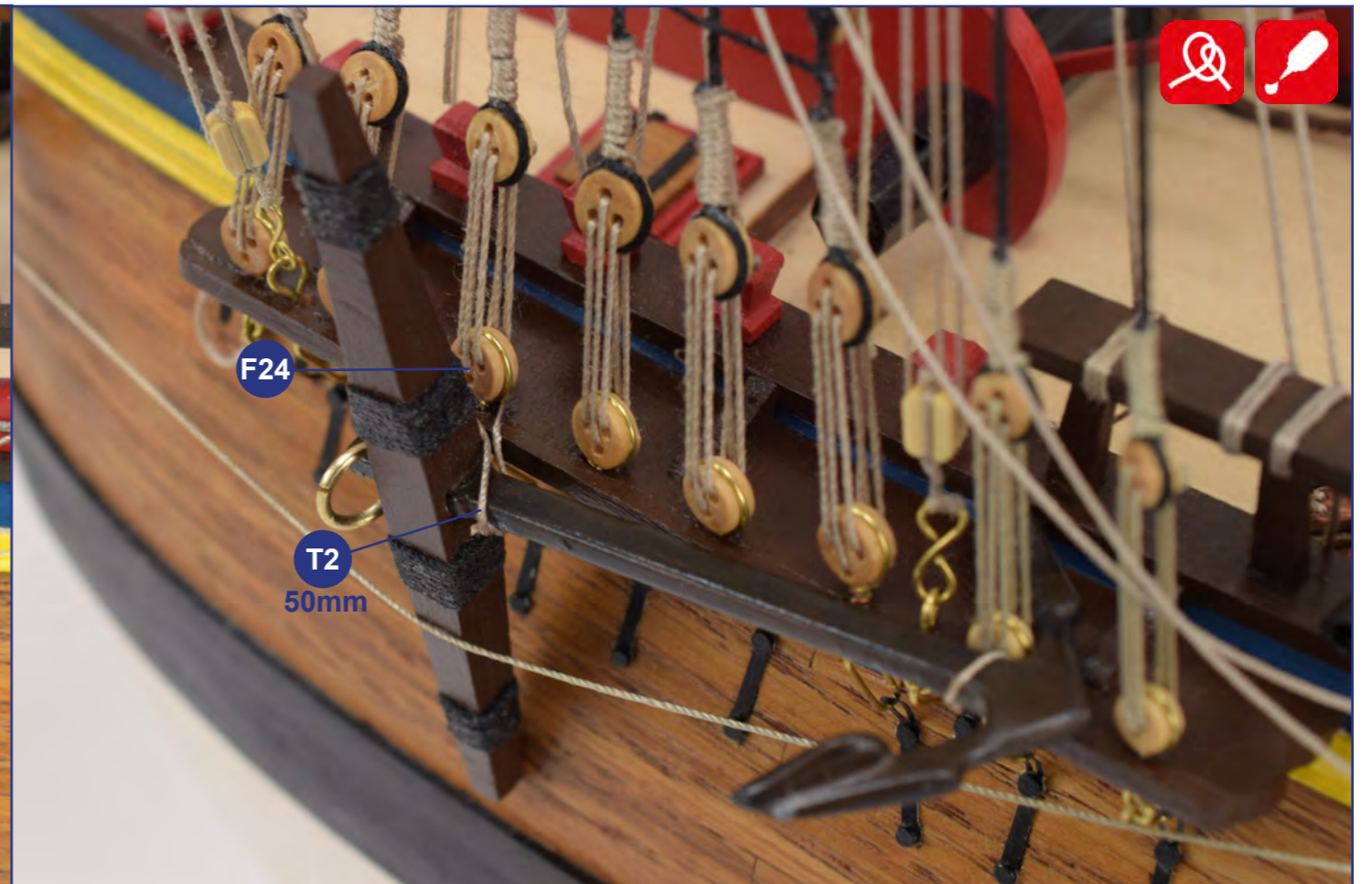
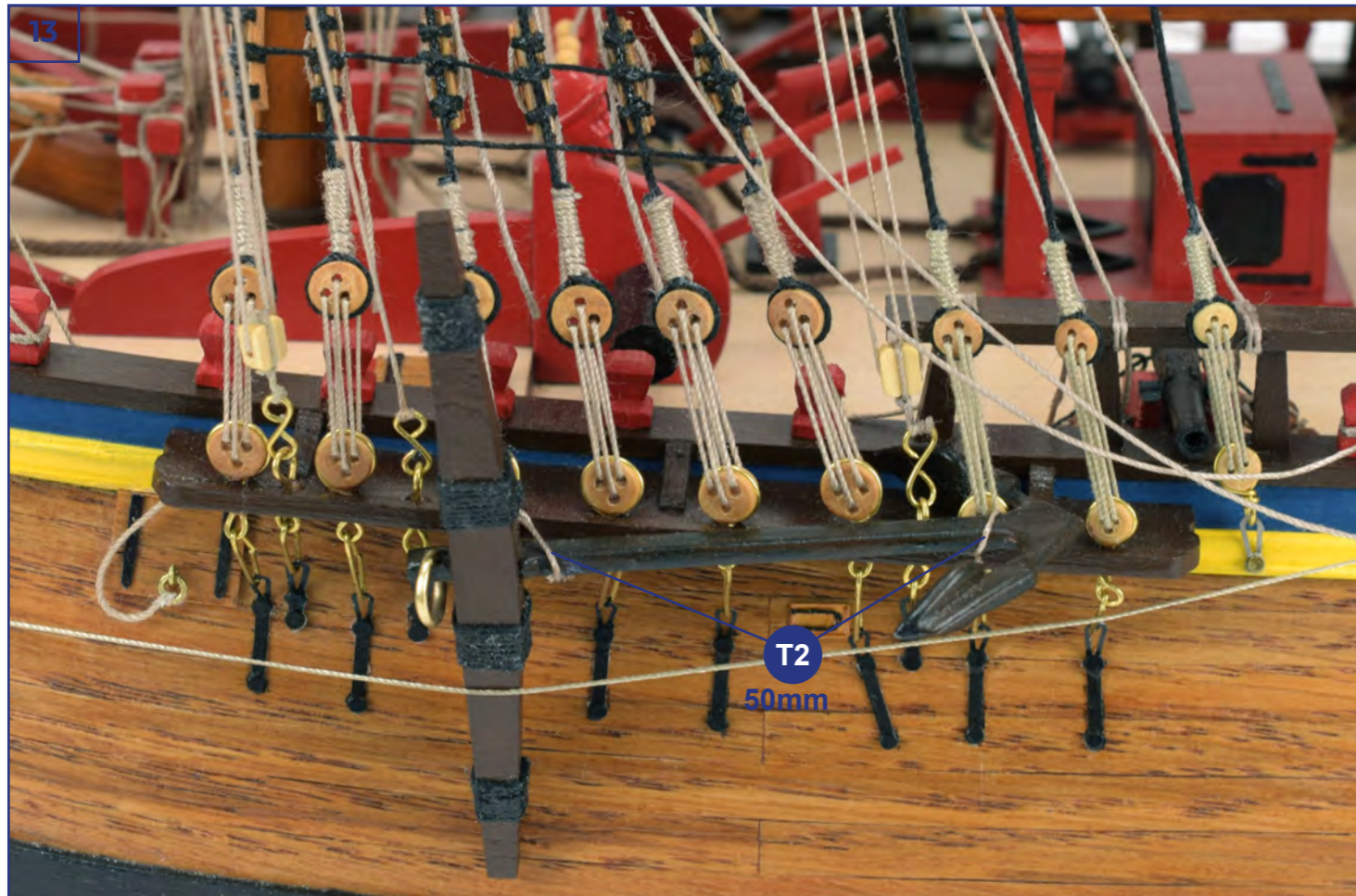

01

LONGBOAT

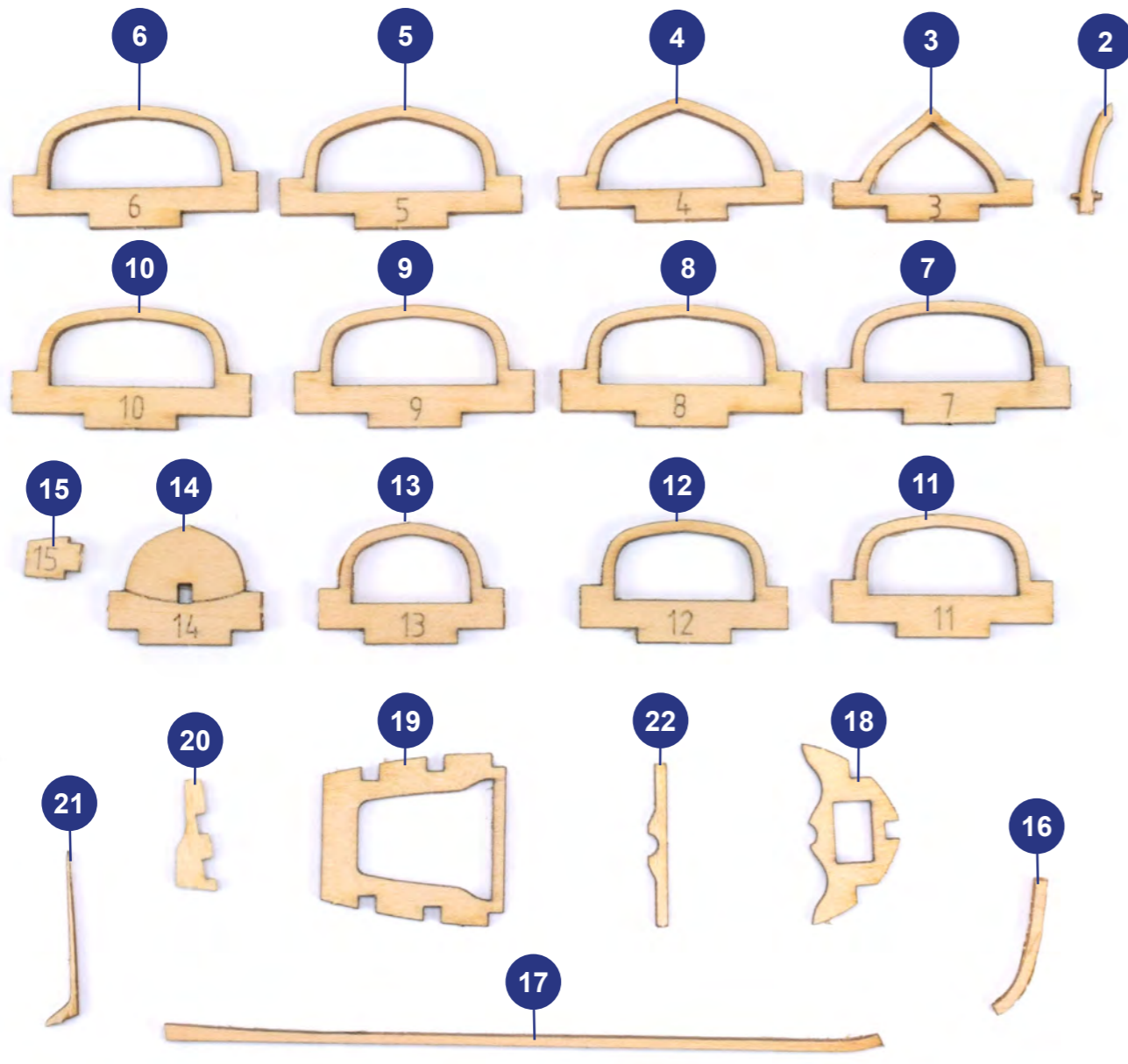

02

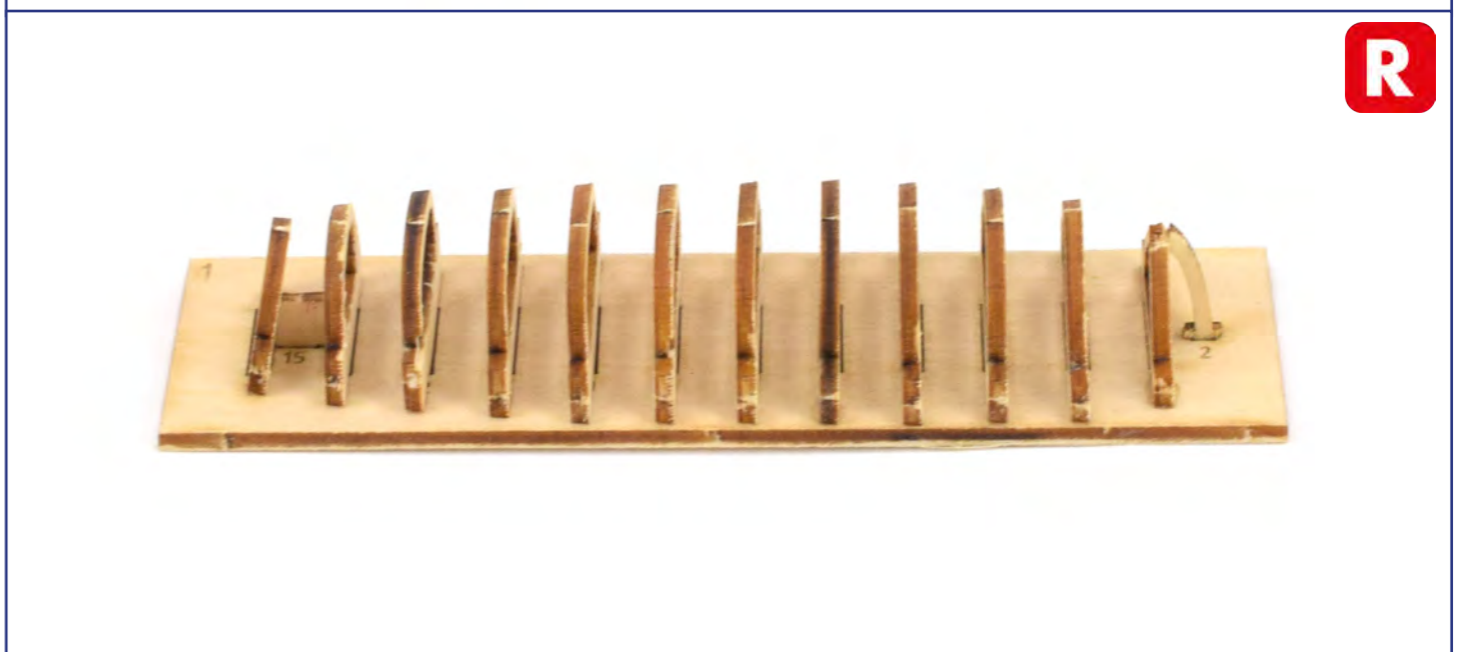
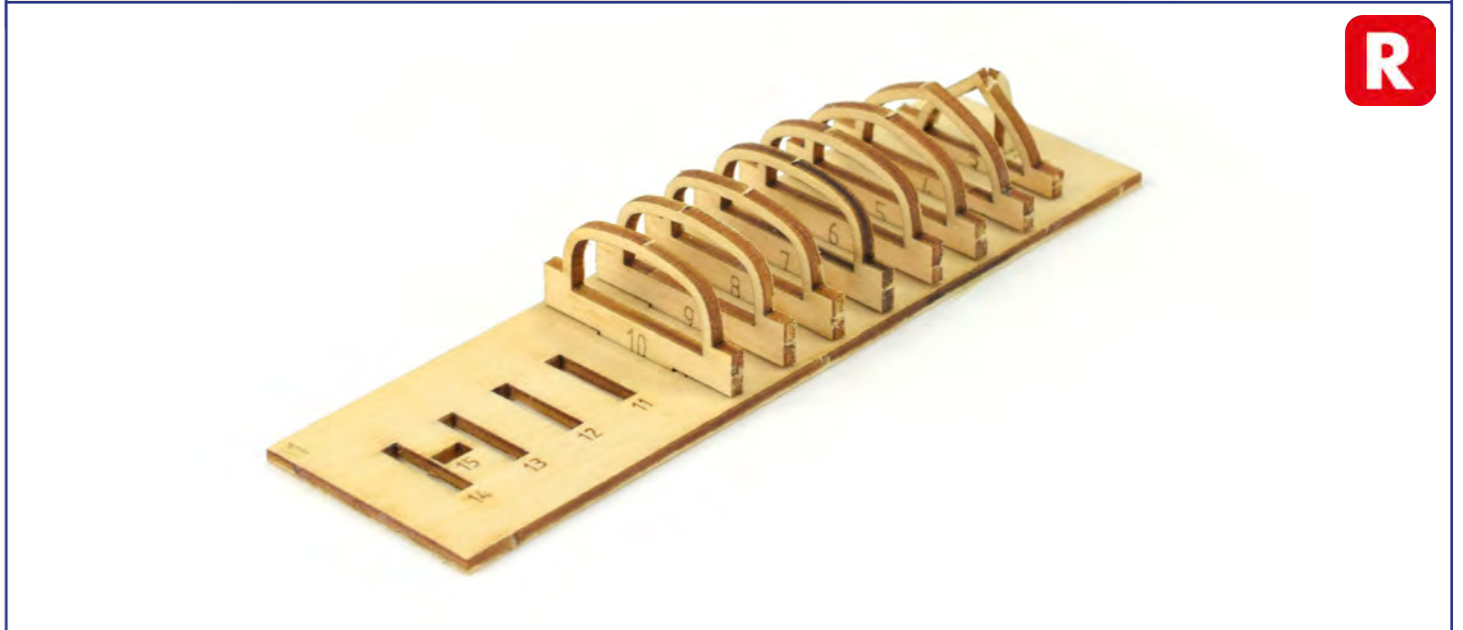
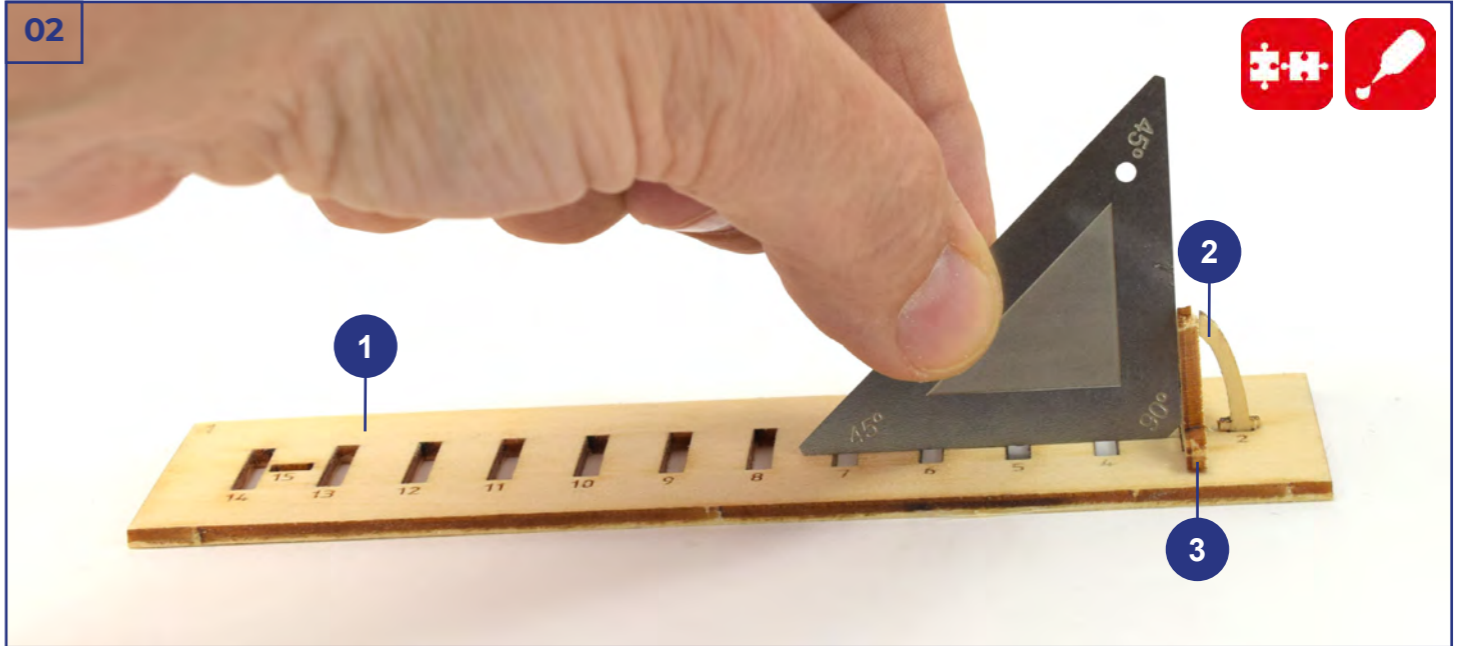

03



04

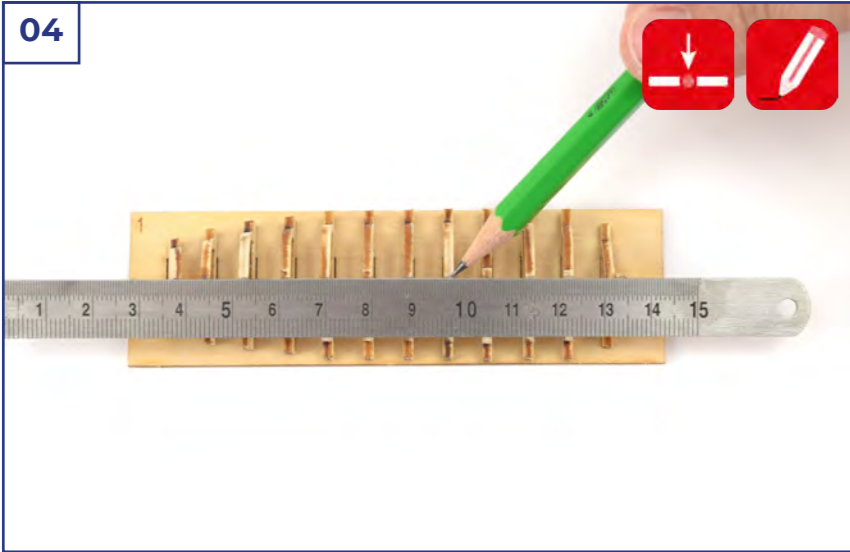

05

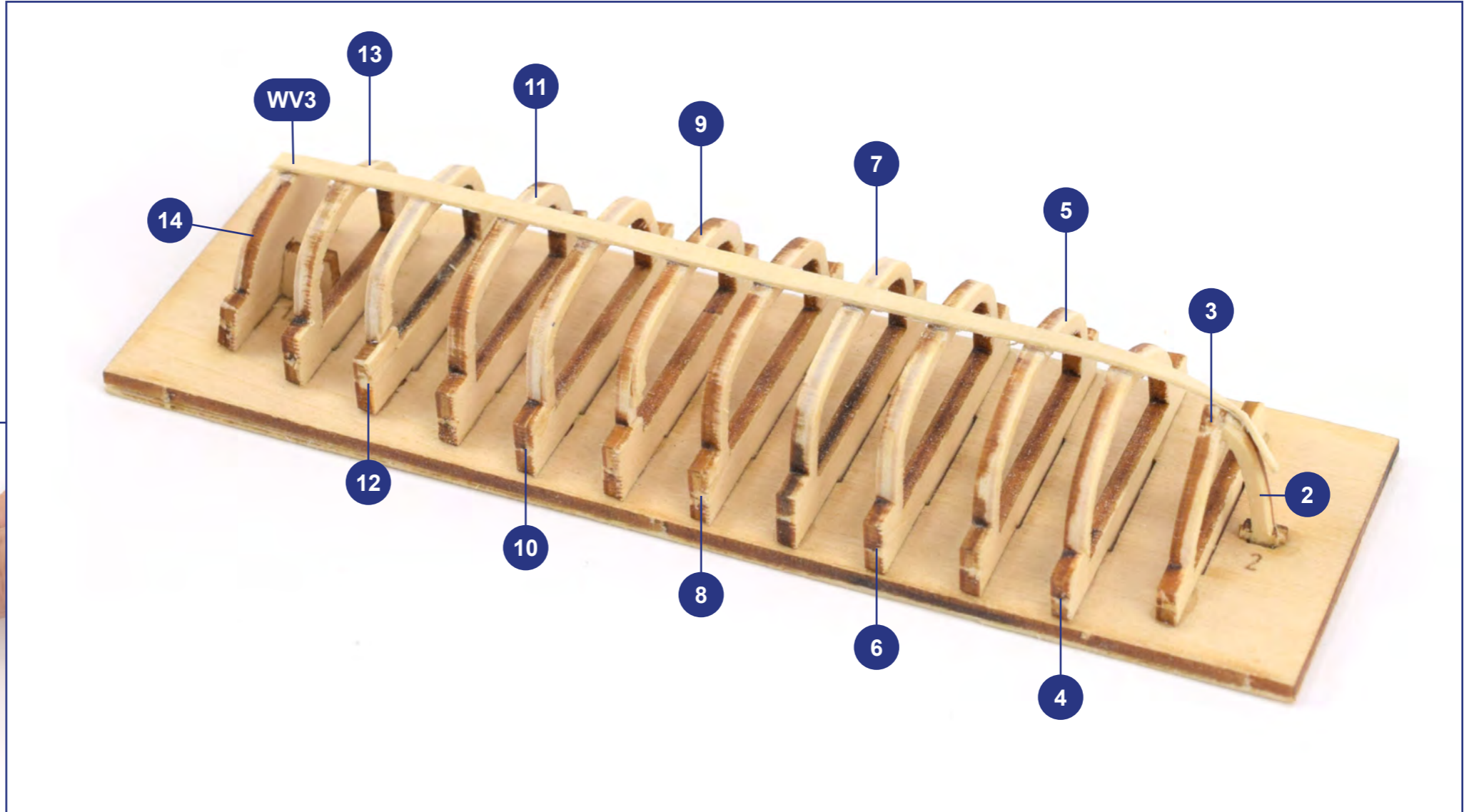
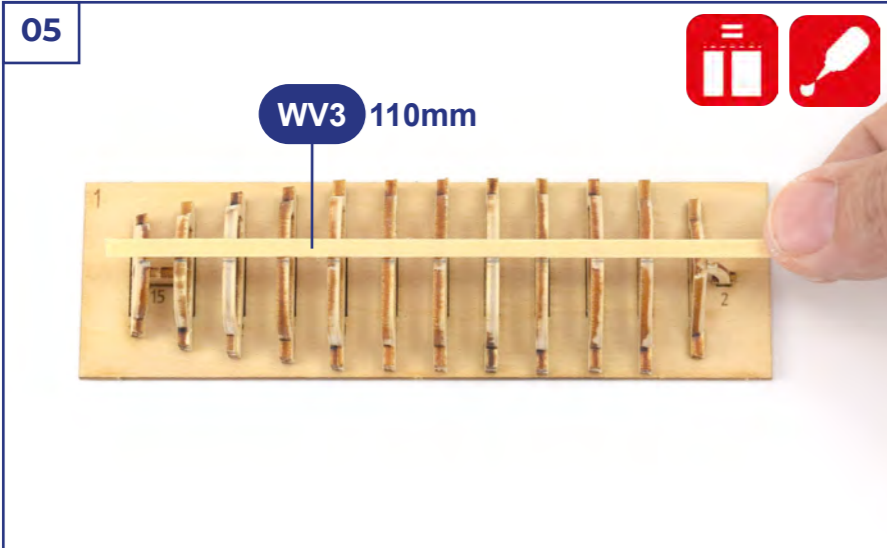

06

R

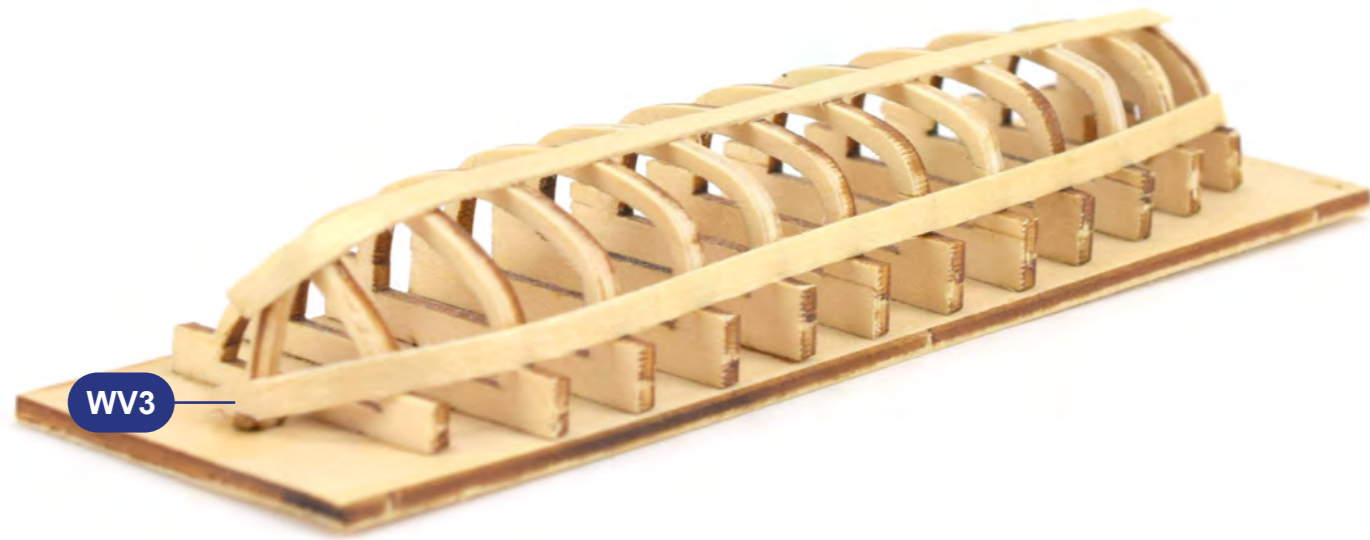

07

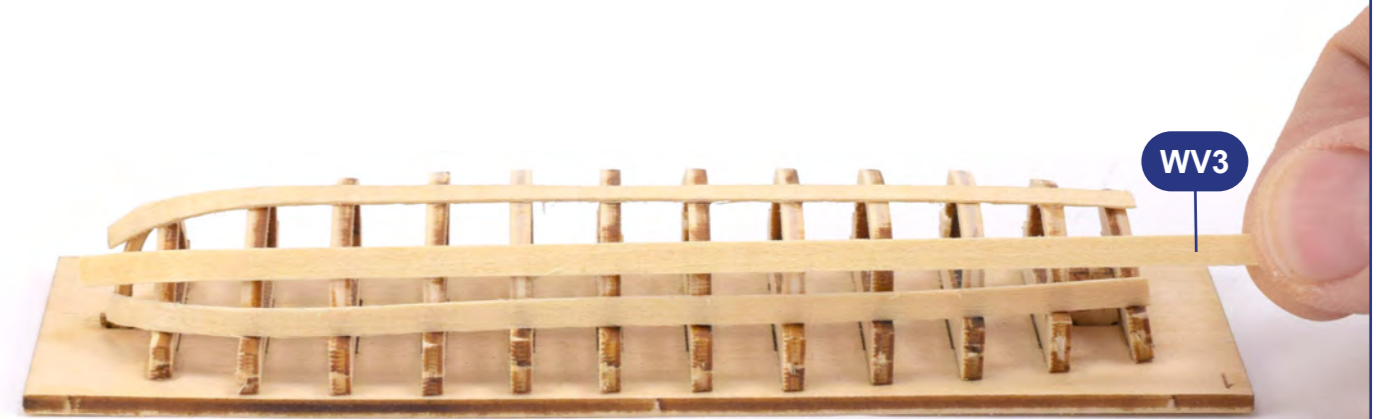

FRONT VIEW

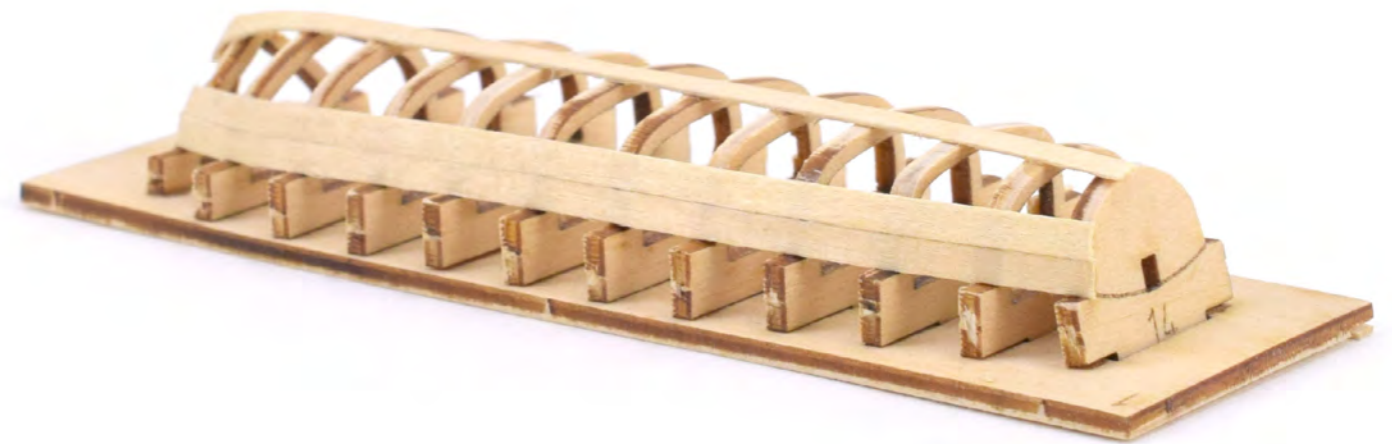

BACK VIEW

08

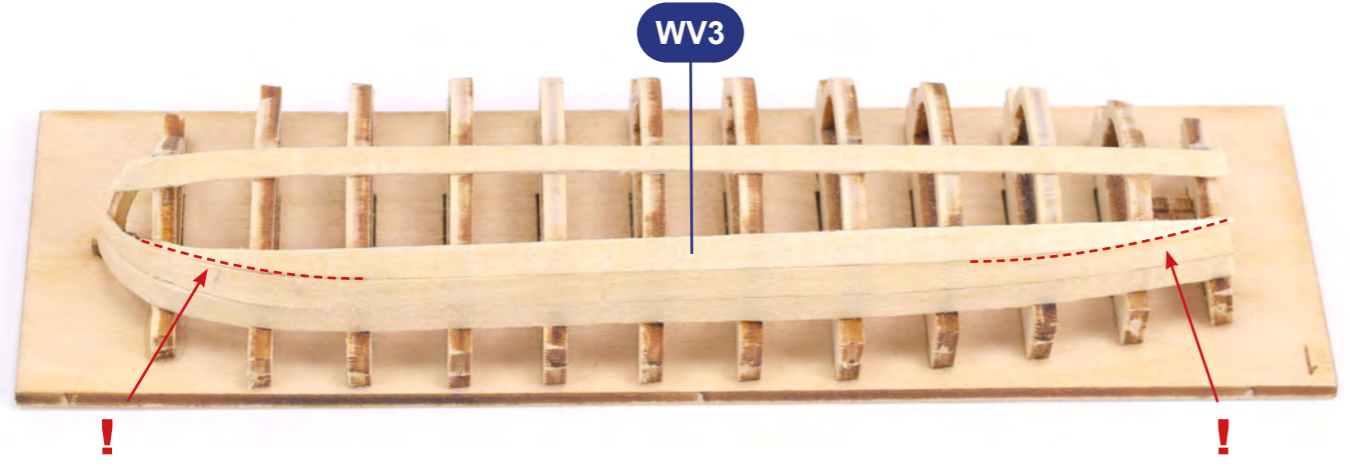

09

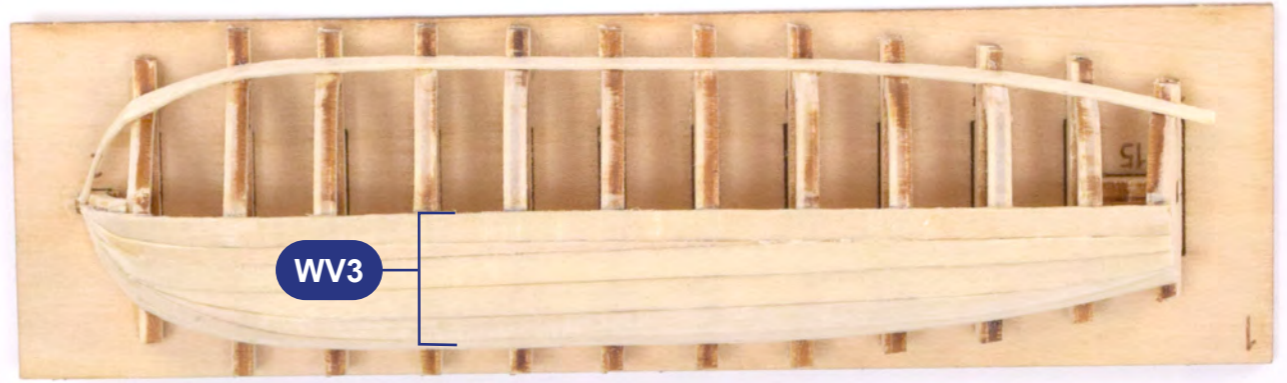

10

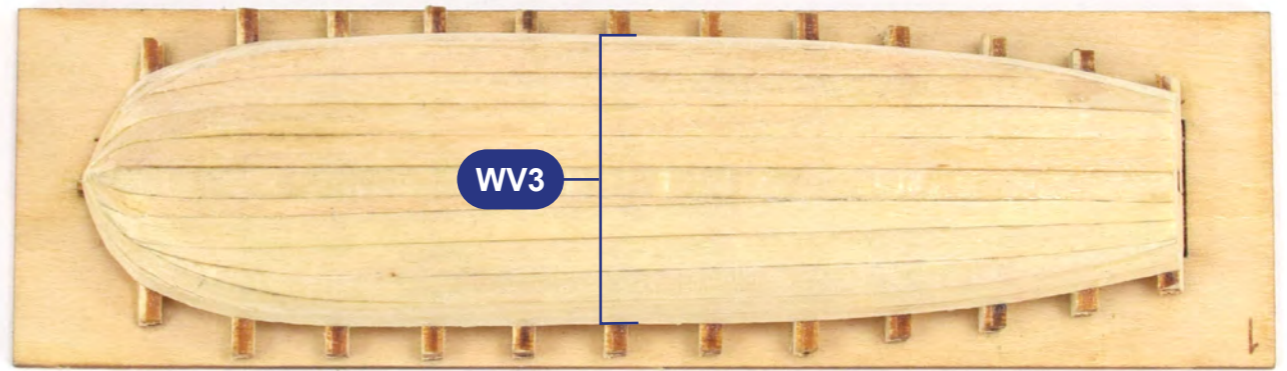
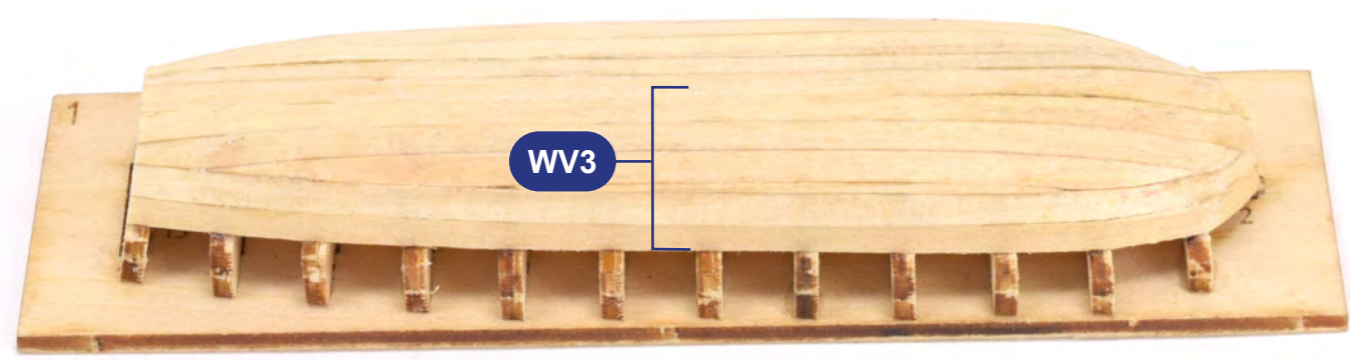

11



12

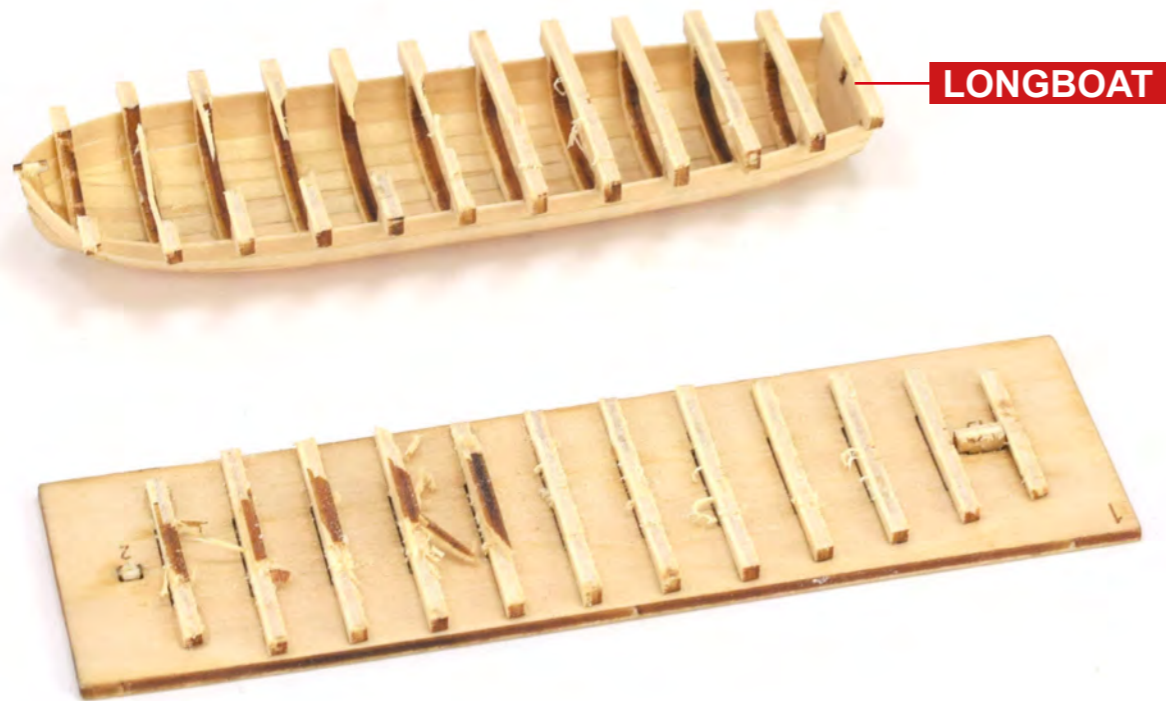

13

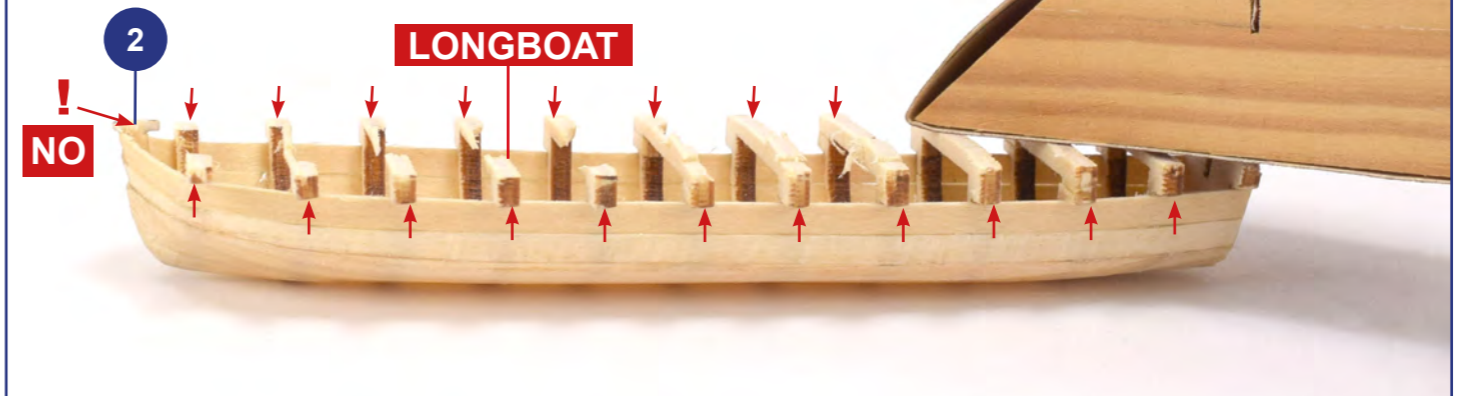

14

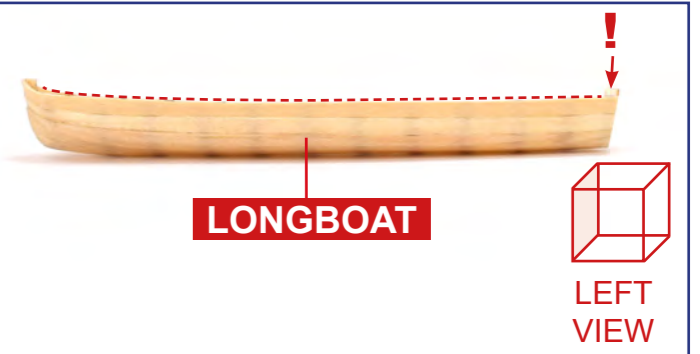

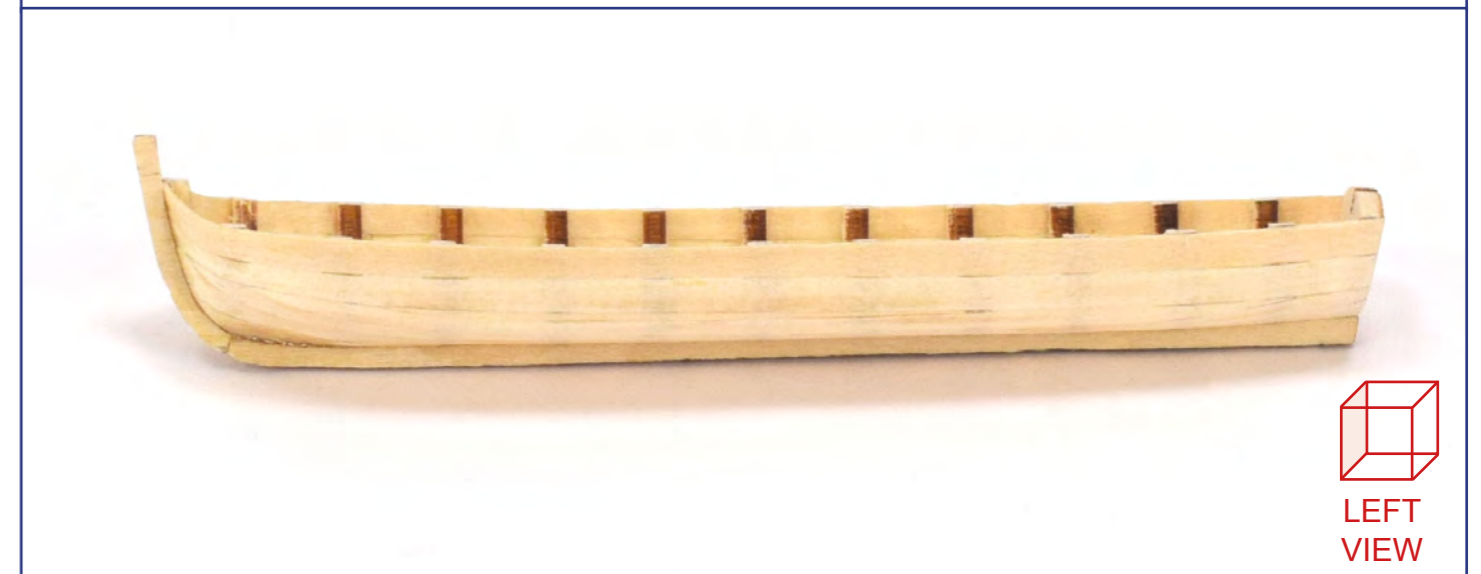
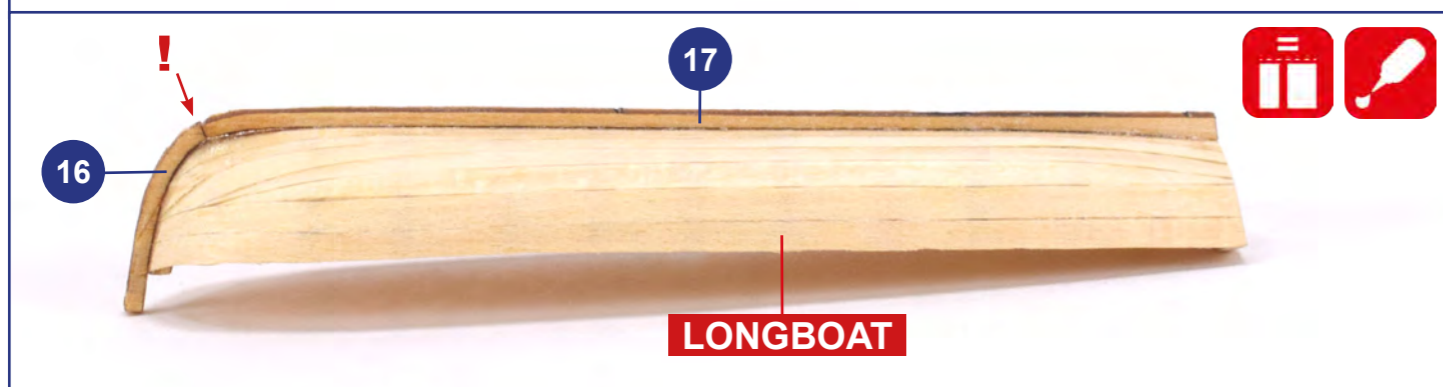

19

LONGBOAT

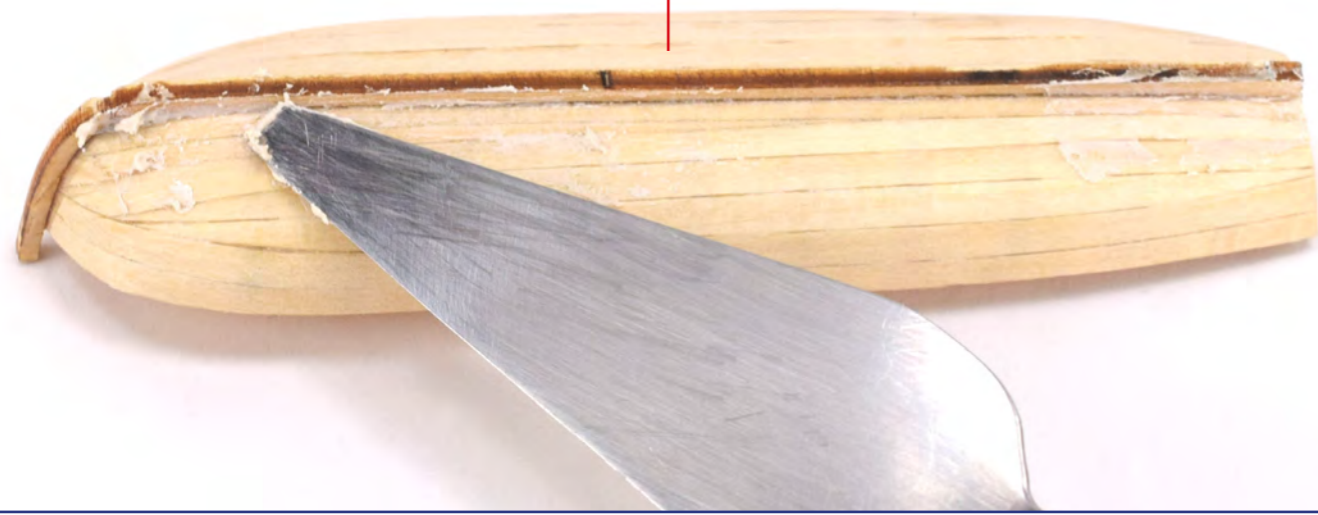

LONGBOAT



LONGBOAT



20

LONGBOAT



Waterline marker
ref.27649
Sold separately

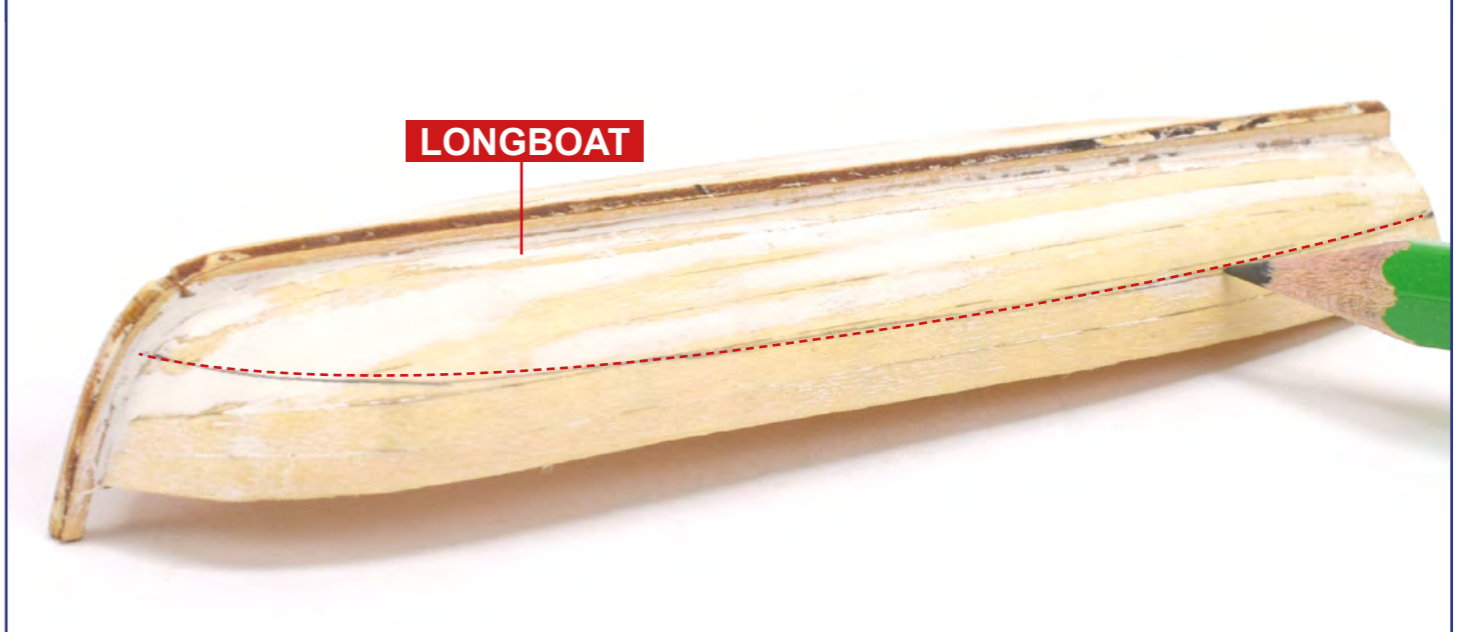

LONGBOAT



TOP VIEW

21



LONGBOAT



LONGBOAT

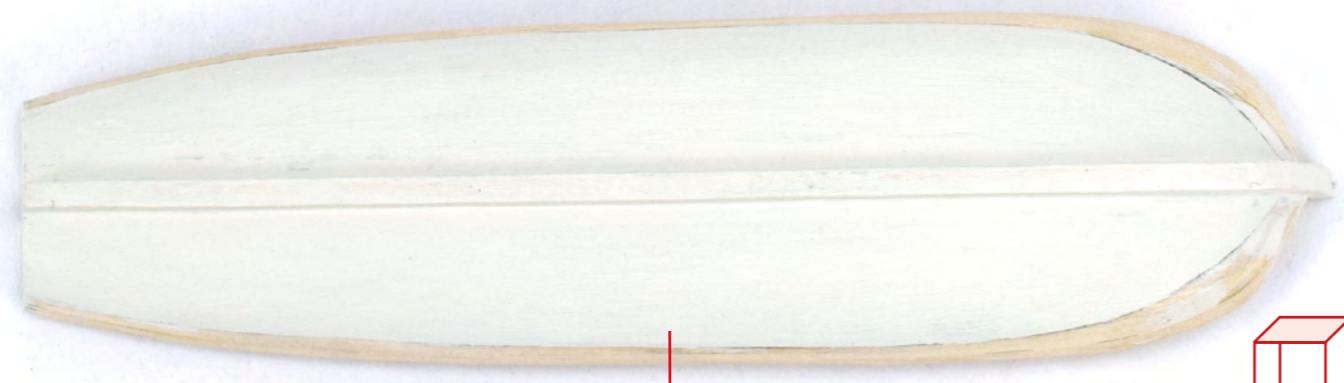

LONGBOAT



TOP VIEW

22

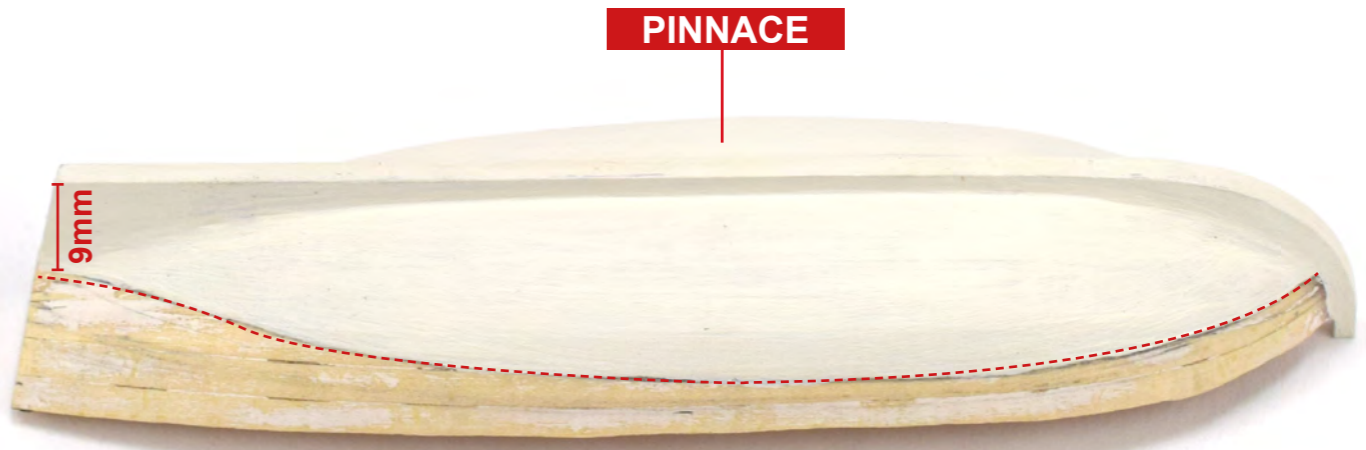

PINNACE

9mm

PINNACE



TOP VIEW

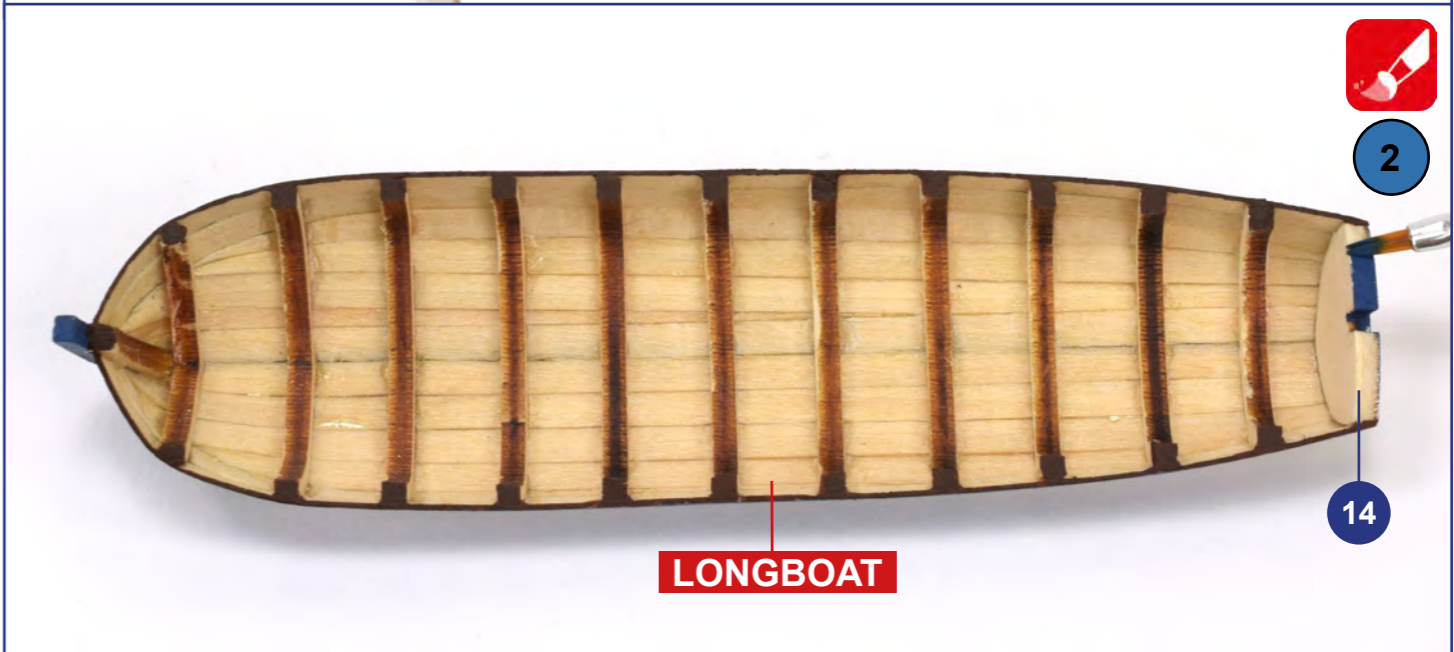
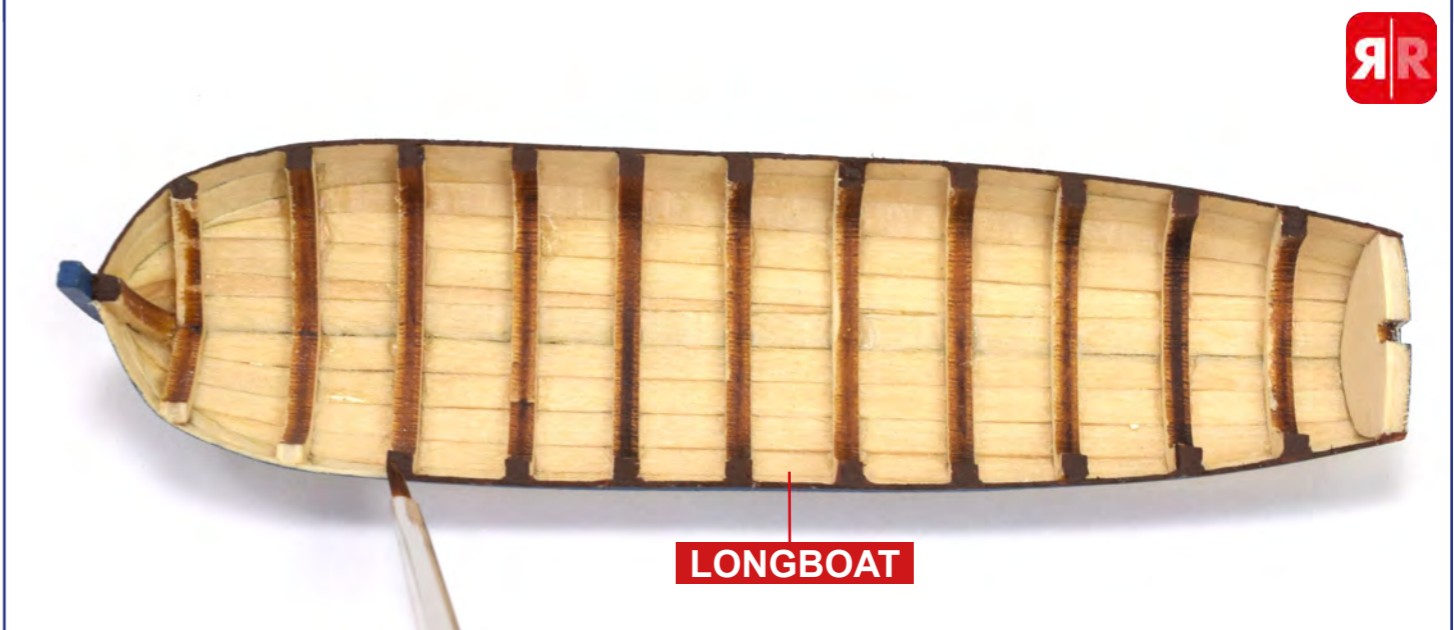
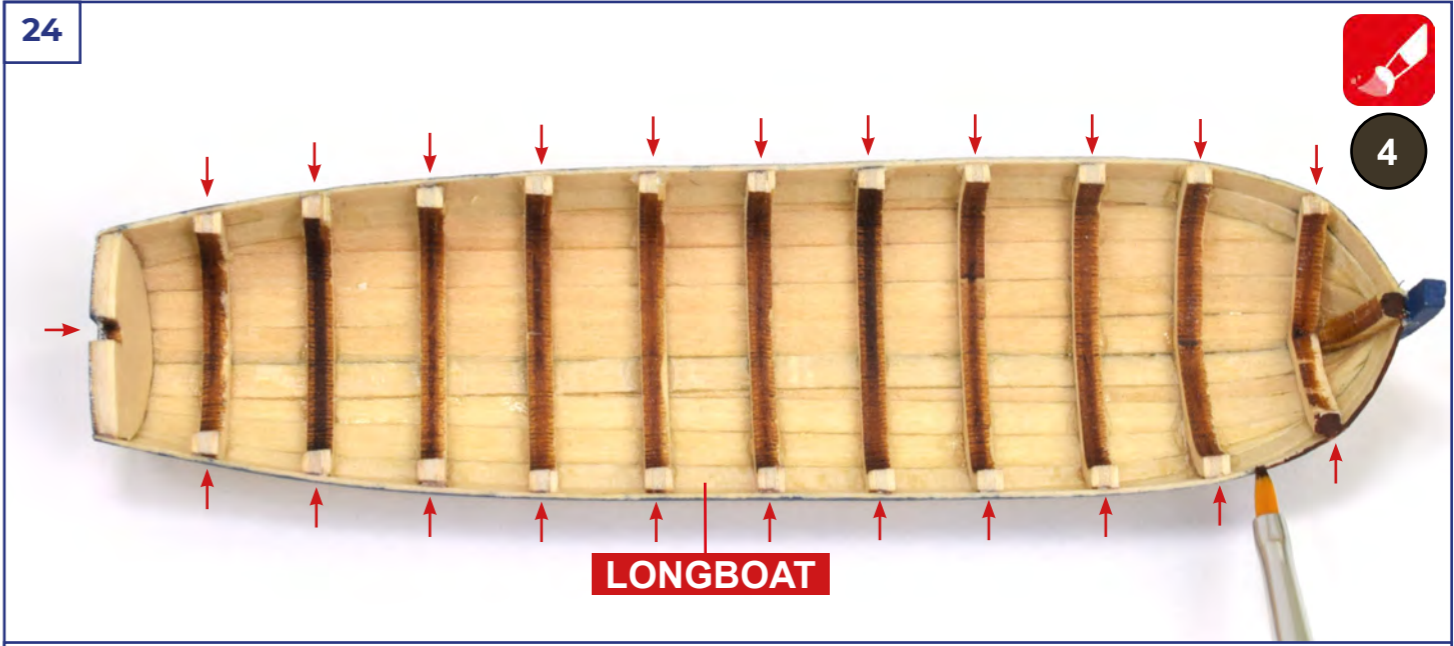
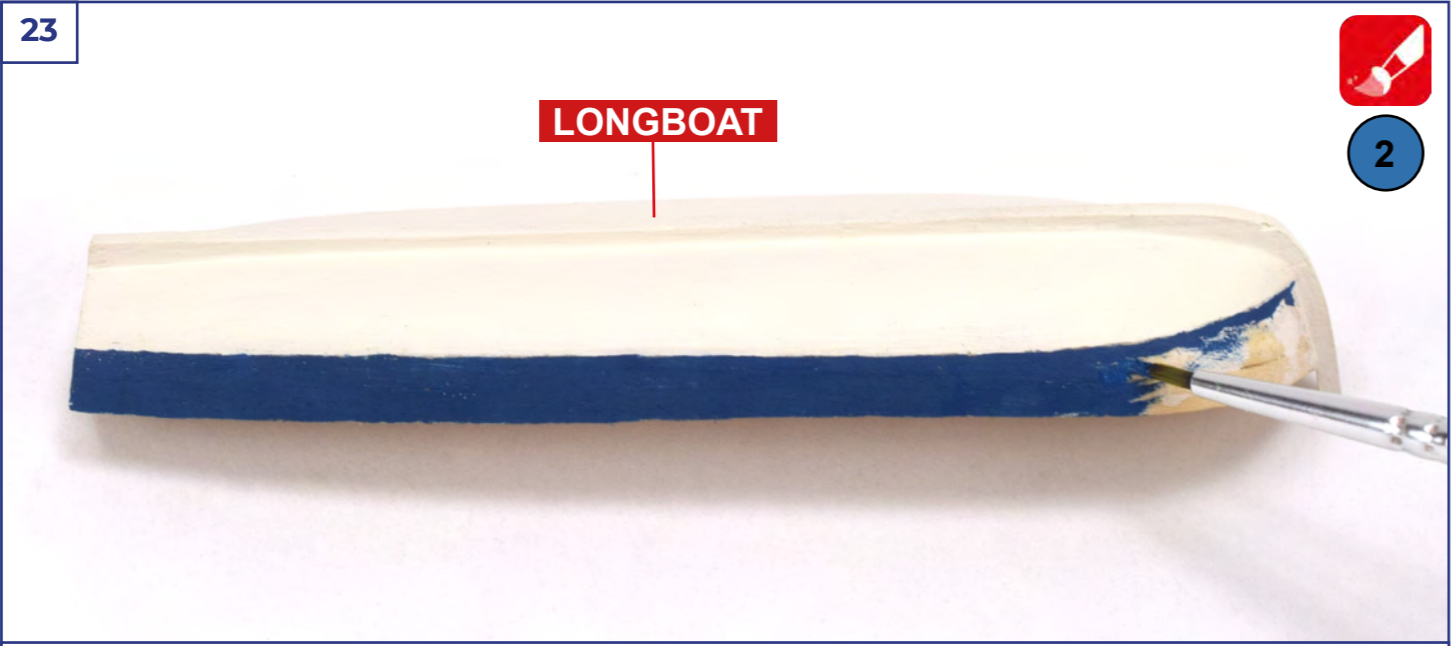

25



5



WS2



LONGBOAT

WS2



WS2

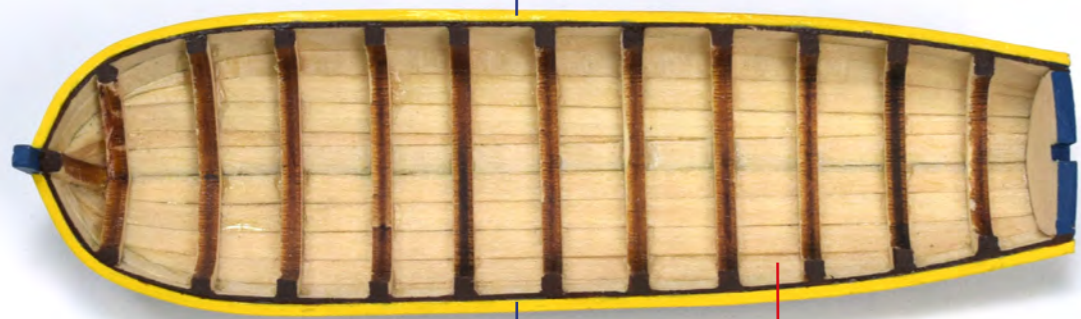

LONGBOAT

WS2

26



WV4
90mm

WV2
90x2mm

WV4
90mm

TEMPLATE 3

WV4

WV2

TEMPLATE 3

WV4

WV2

WV4

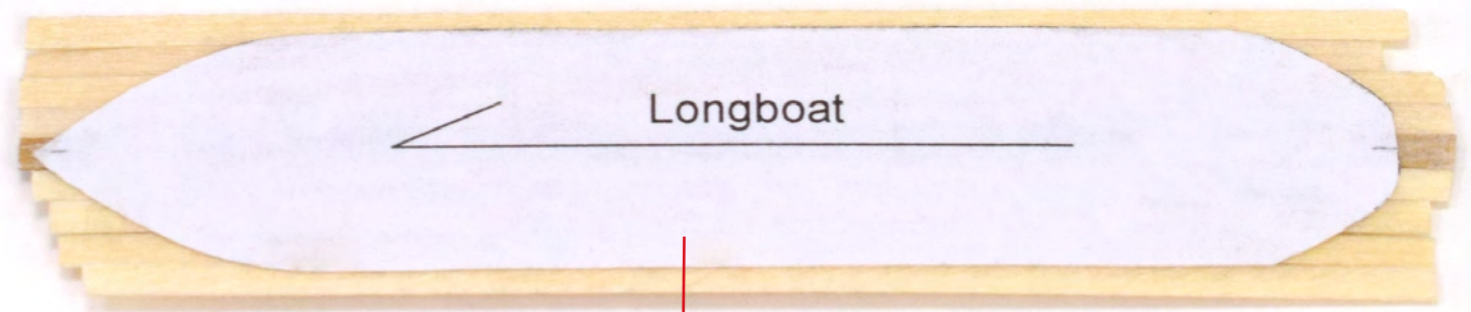

TEMPLATE 3

27

WV4

WV2

WV4

Longboat

TEMPLATE 3

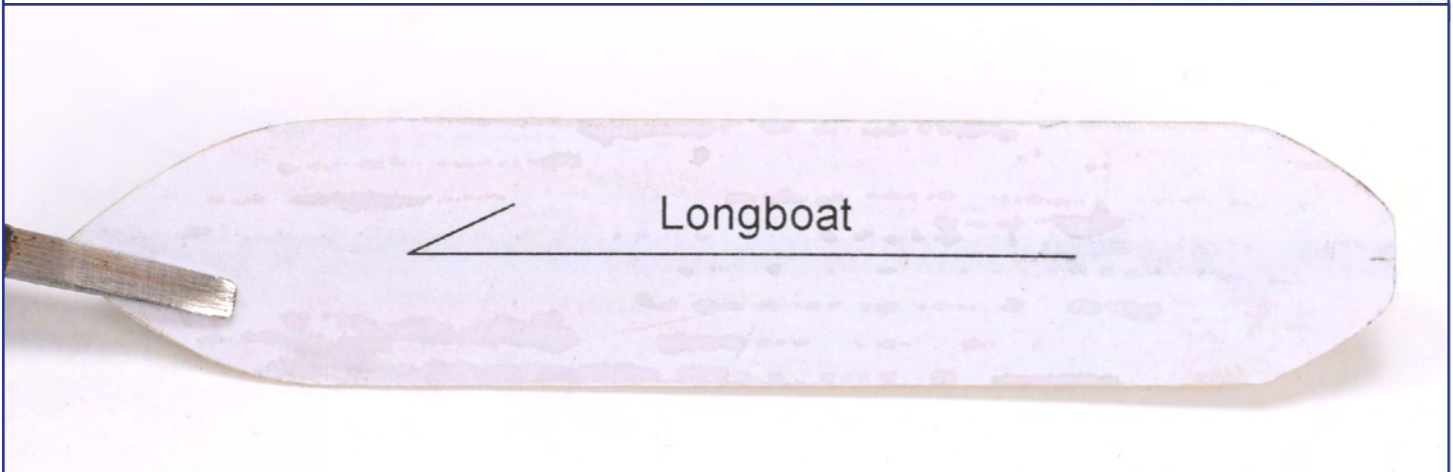

28

WV4 + WV2

LONGBOAT

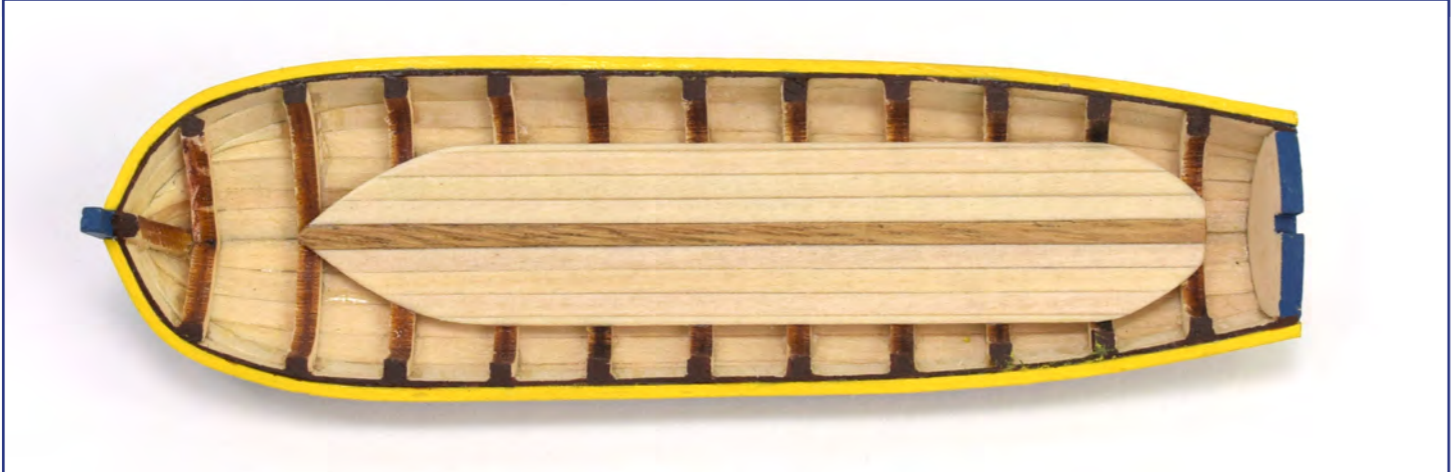
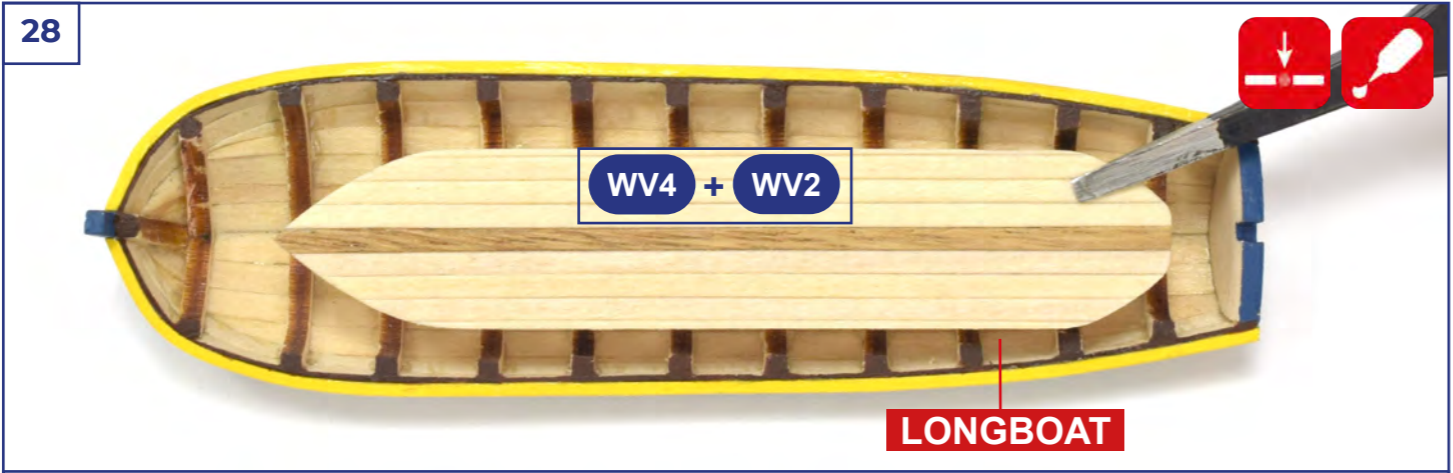

29

WS2
95mm



4

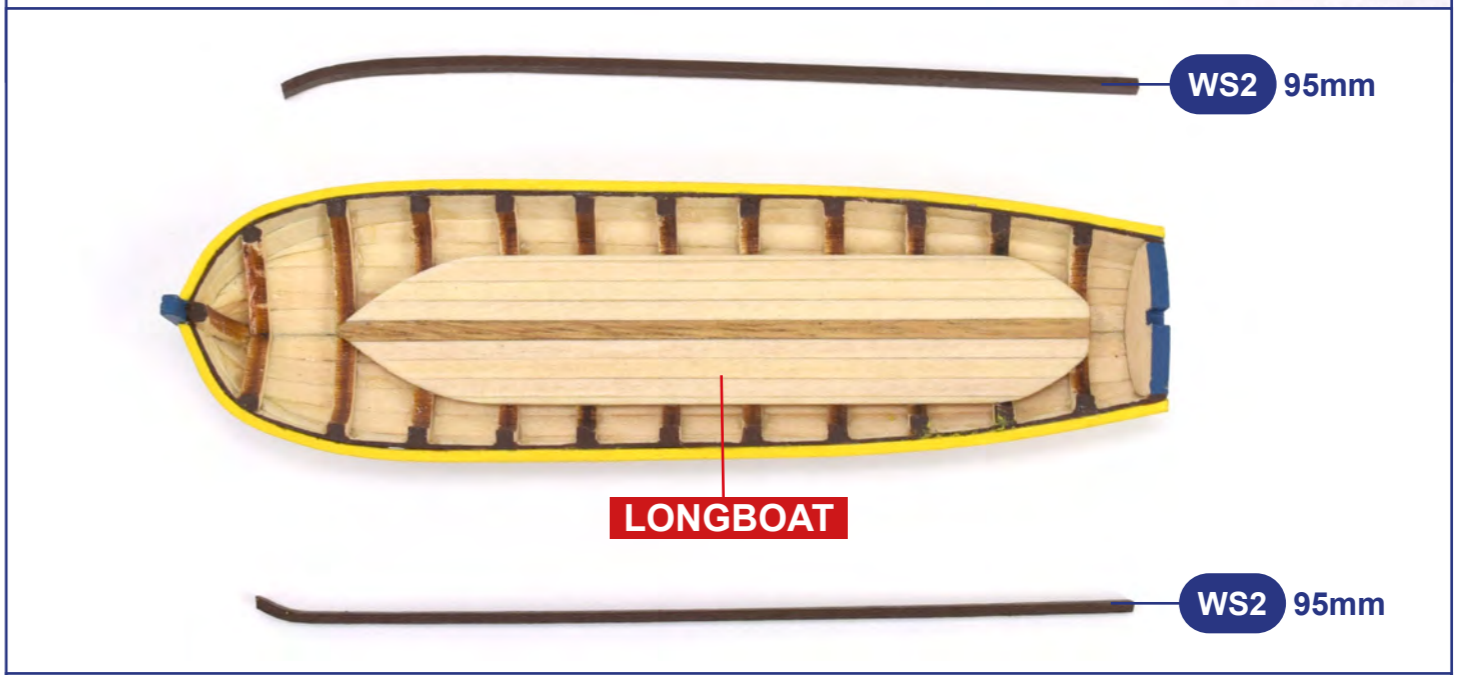

30

18 WS2 25mm 22 WS2 25mm 19 21

12

3 4 5 6 7 8 9 10 11 12 13 14

18 WS2 22 WS2 21 19

31

P33 P33

P33

Ø2,5mm P33

R x2

FRONT VIEW

32

P34 P34

6 9

33

P34 P33

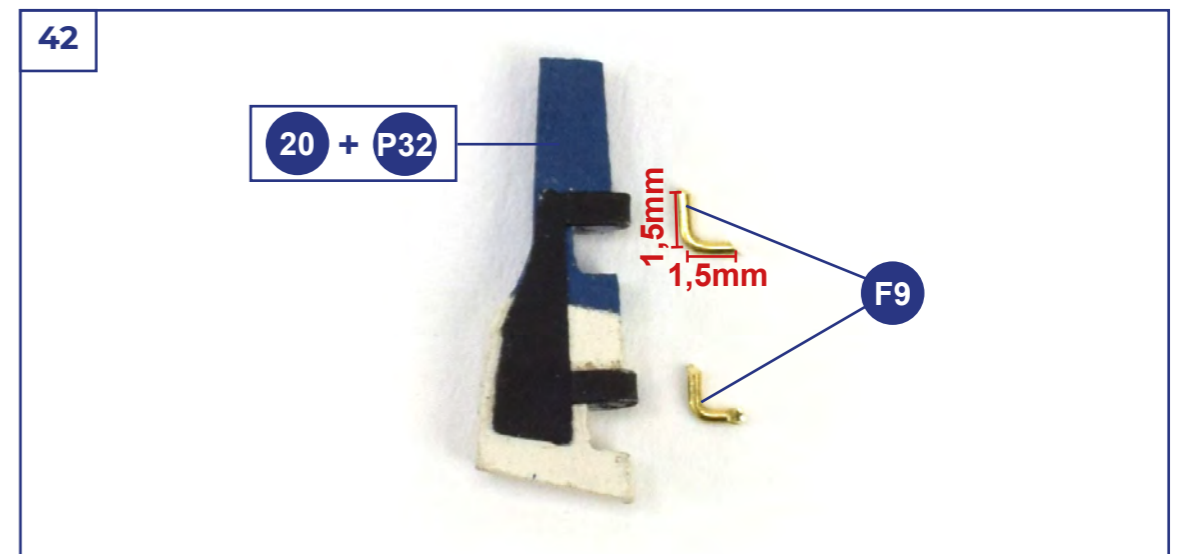
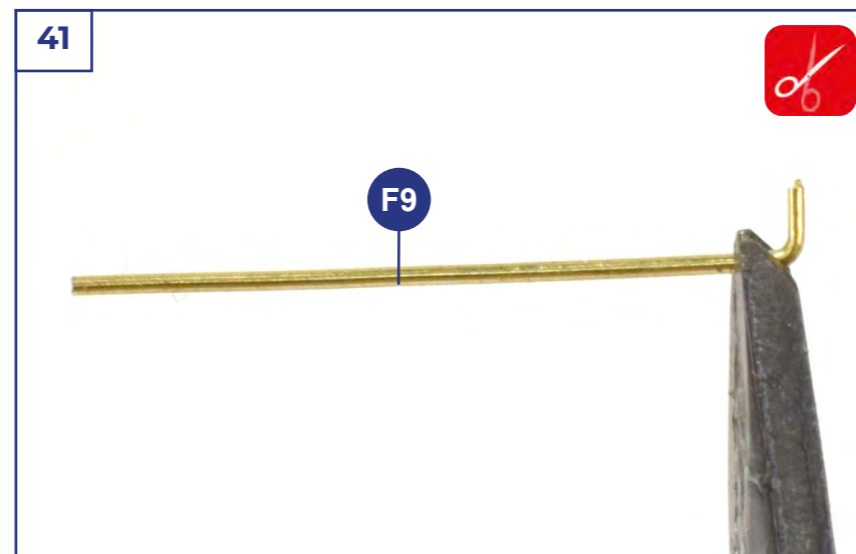
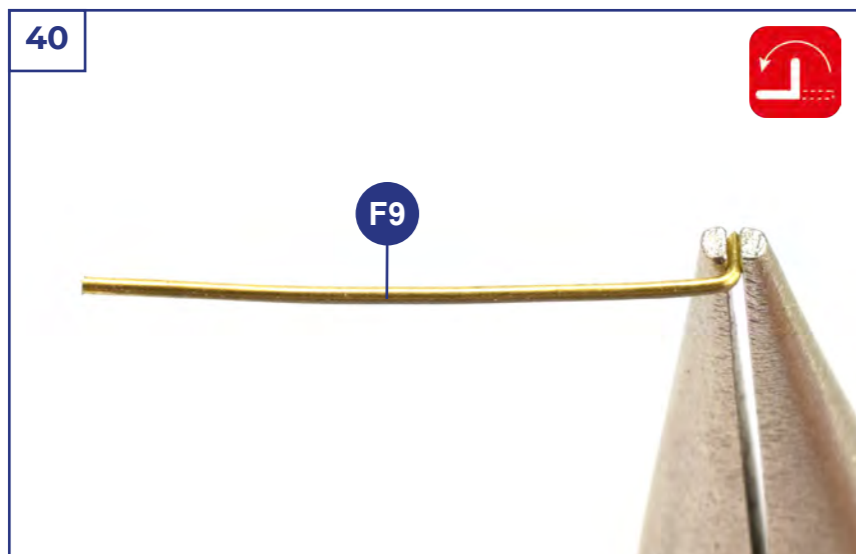
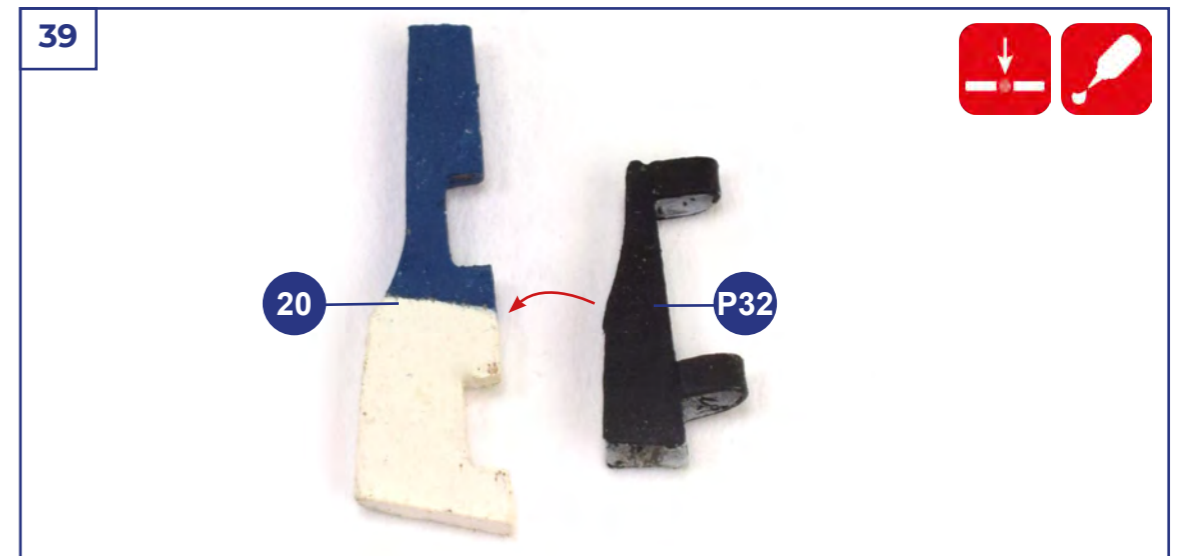
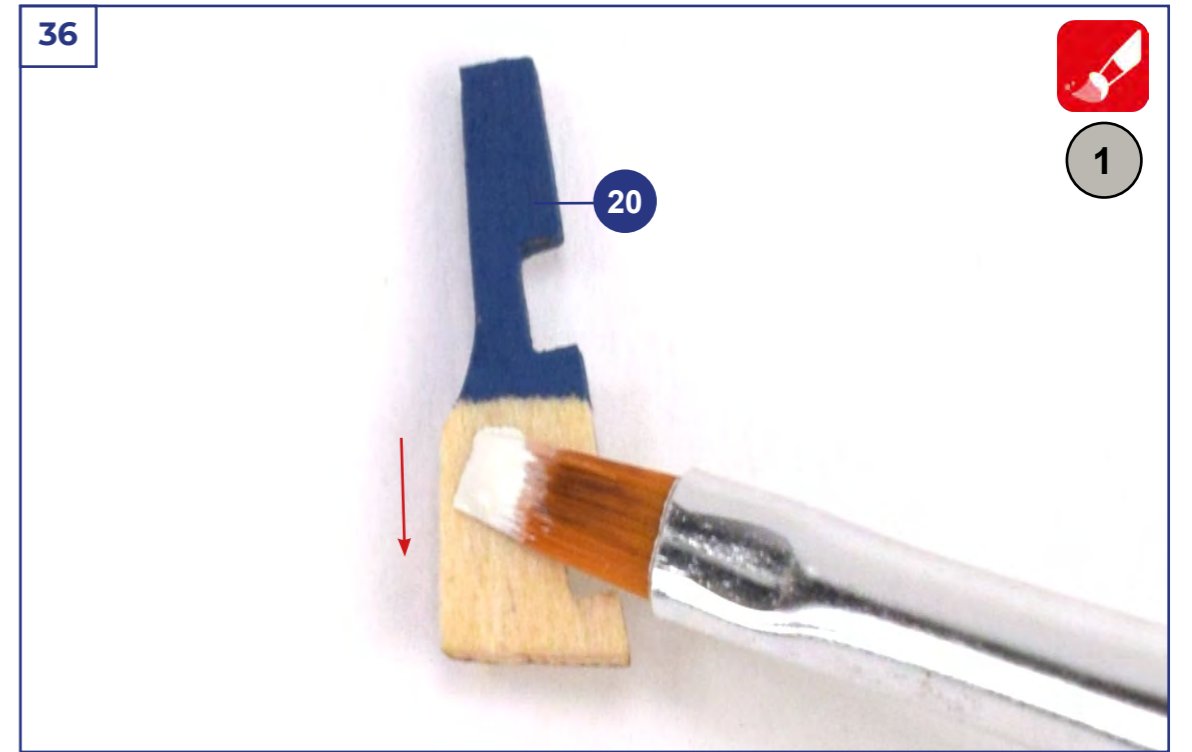
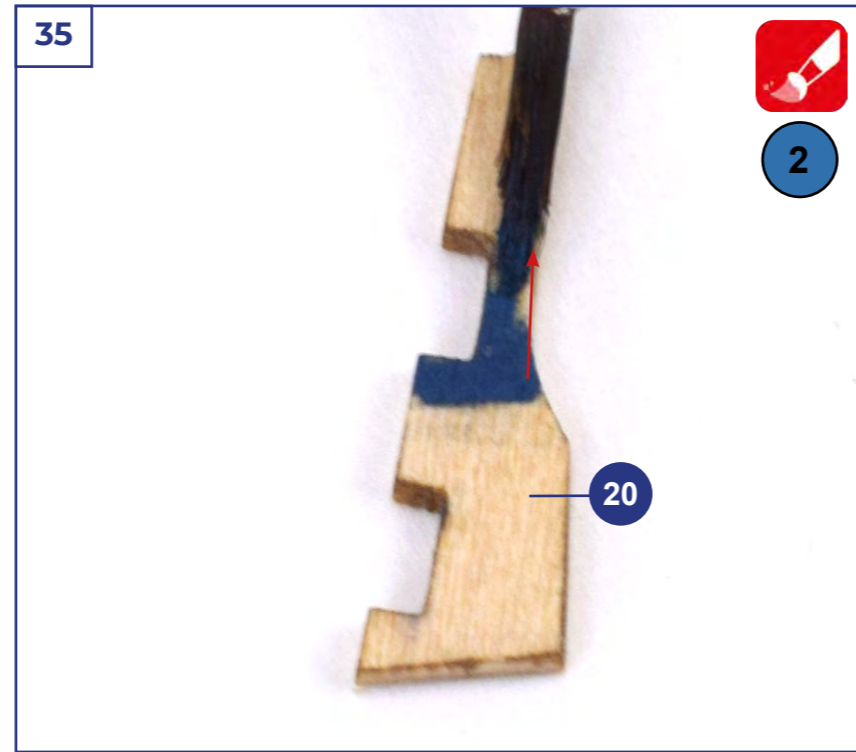
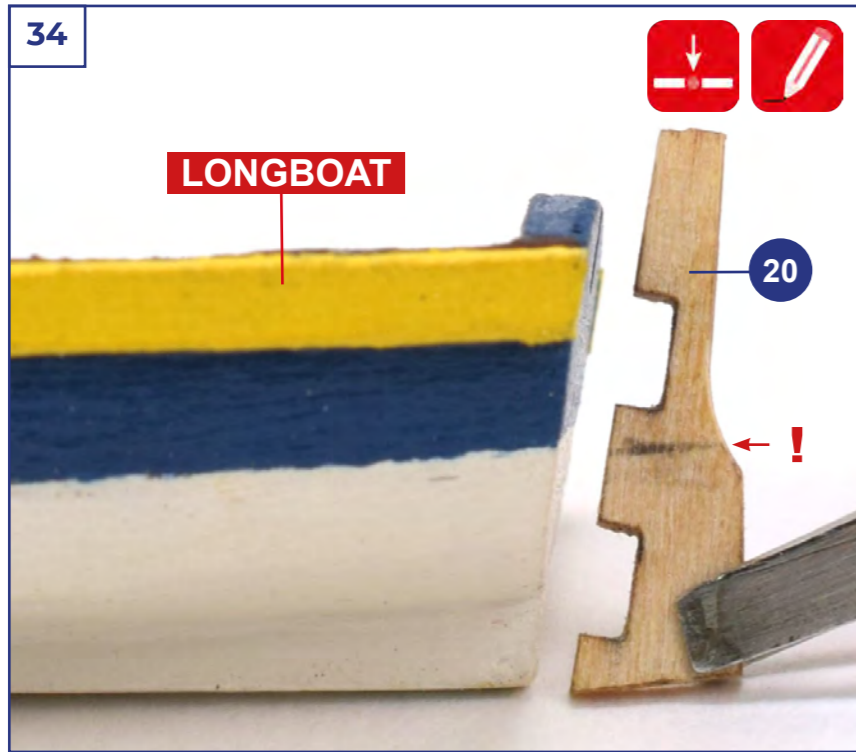

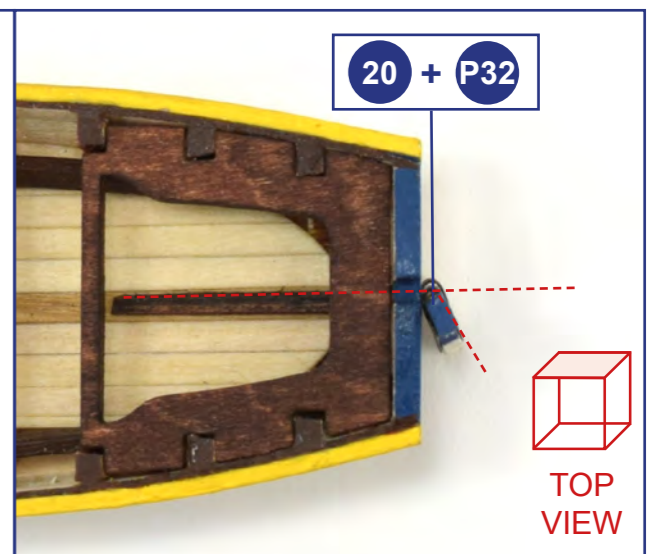
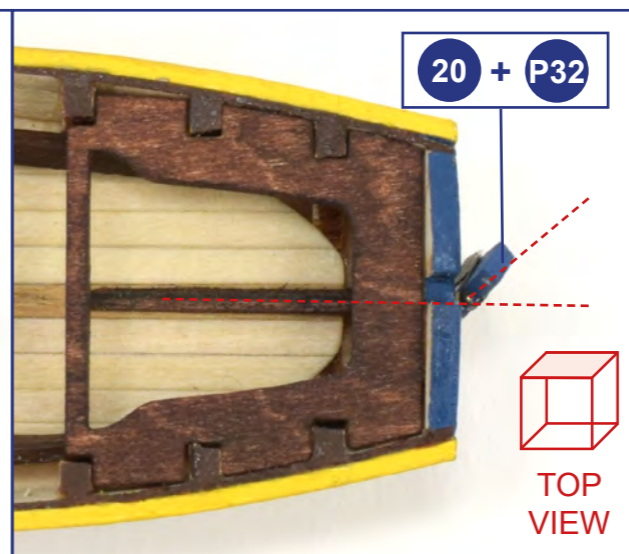
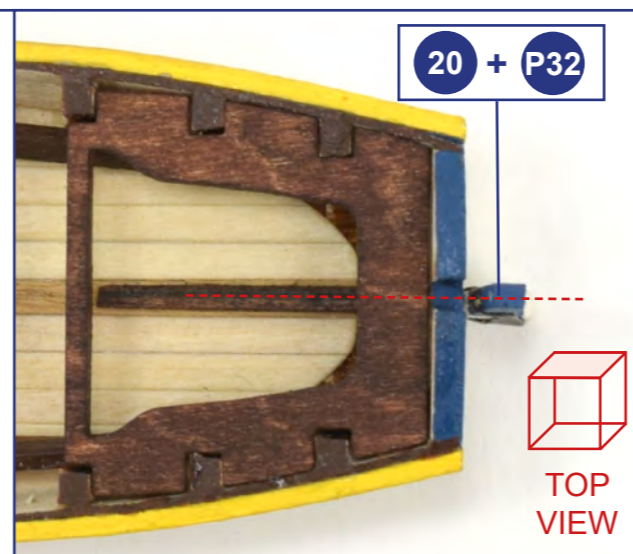
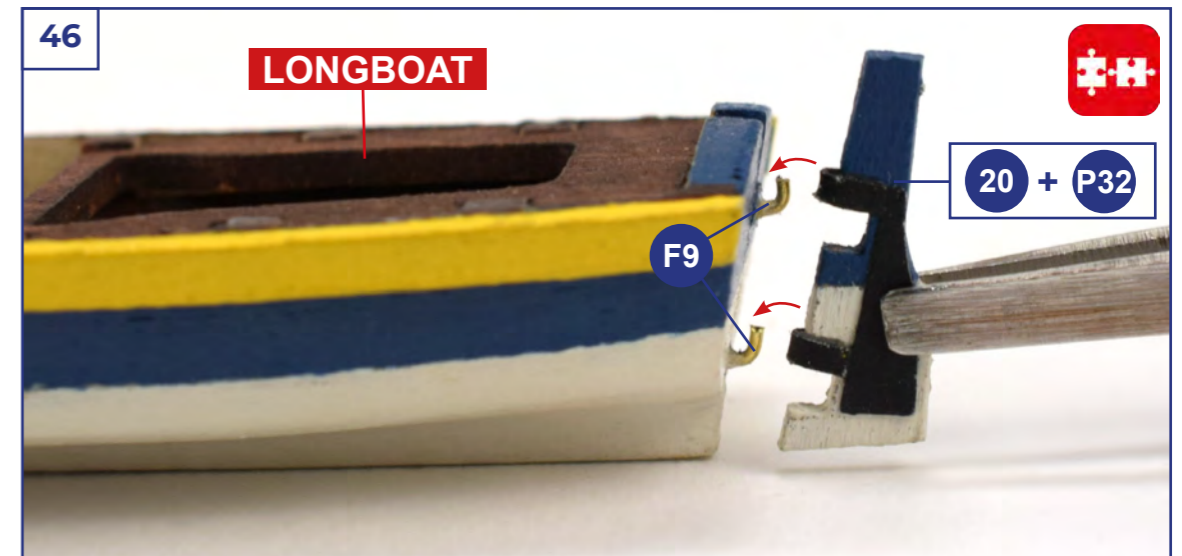
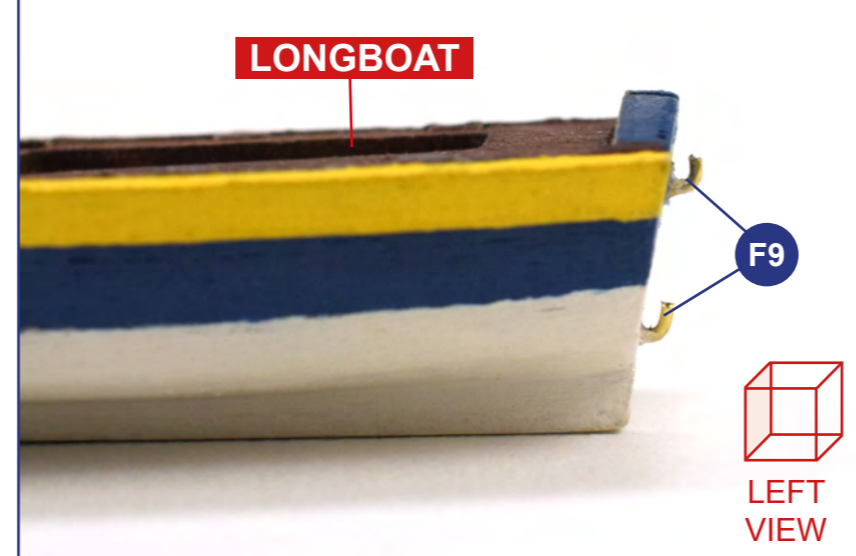
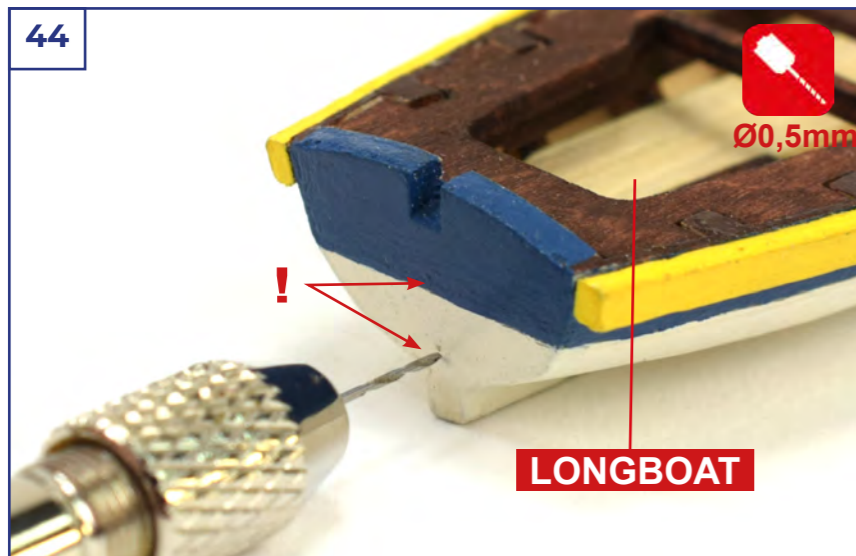
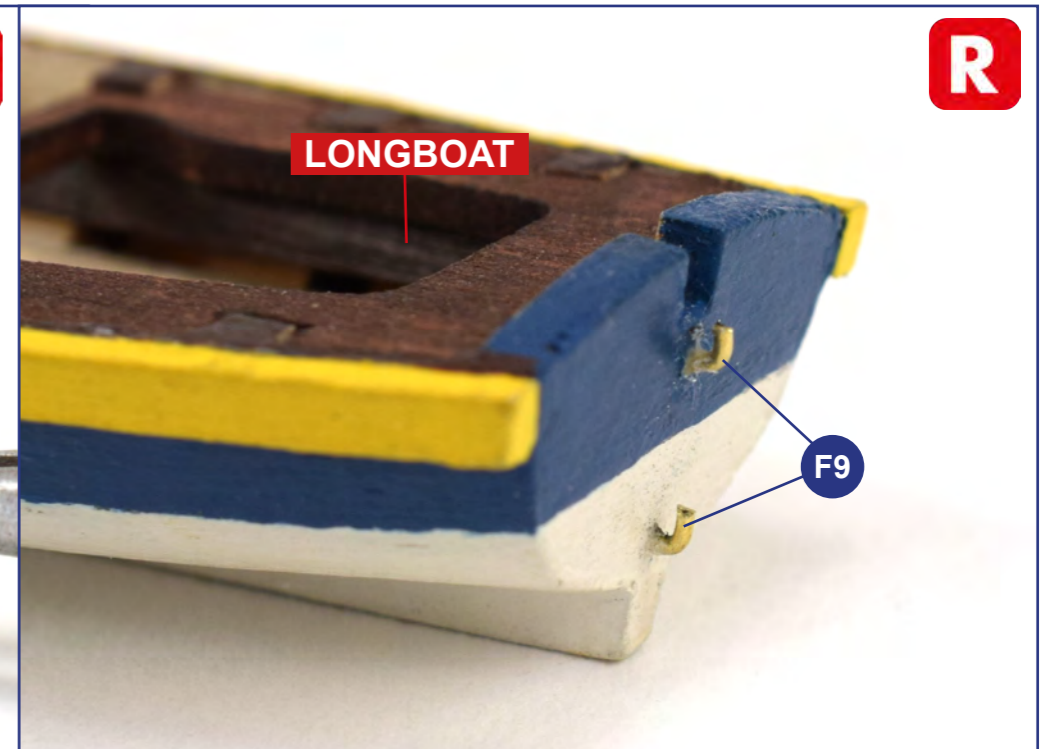
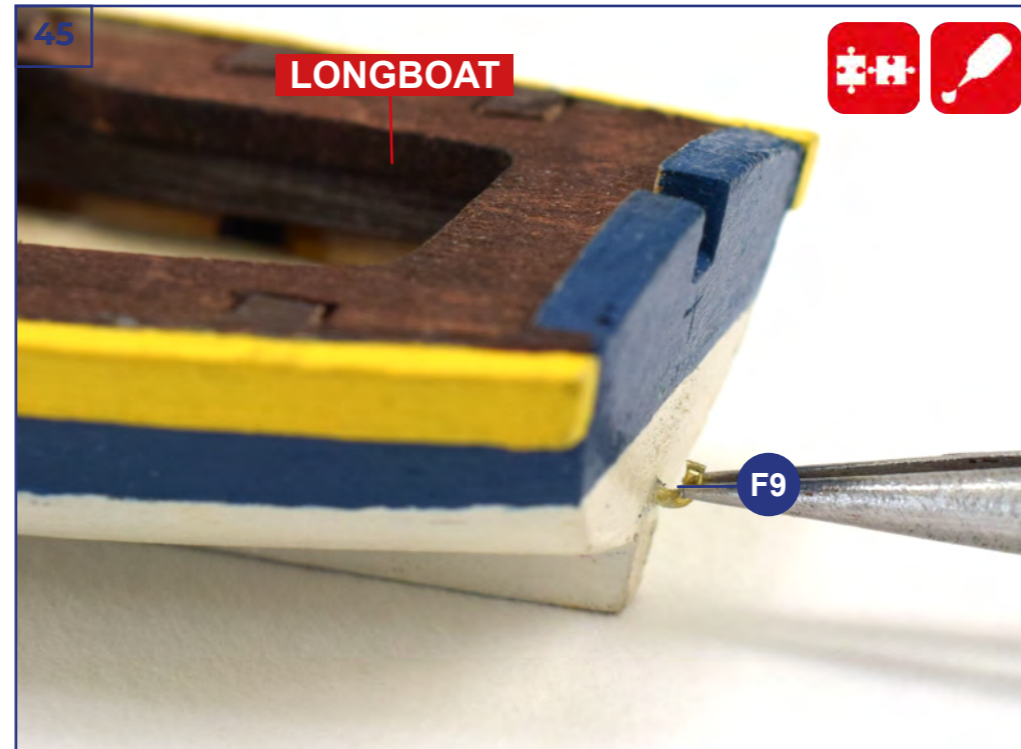
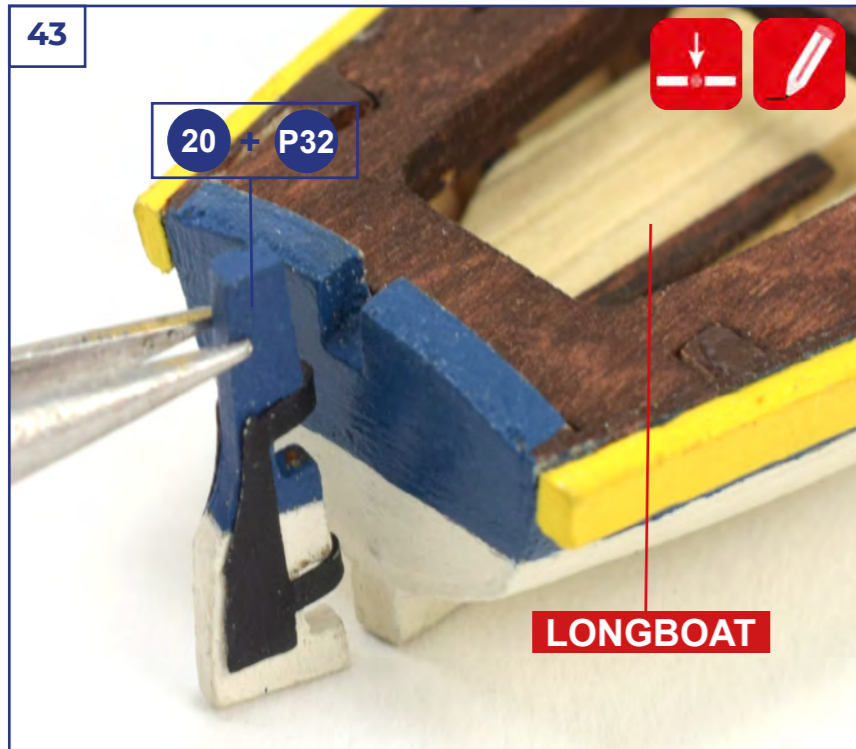

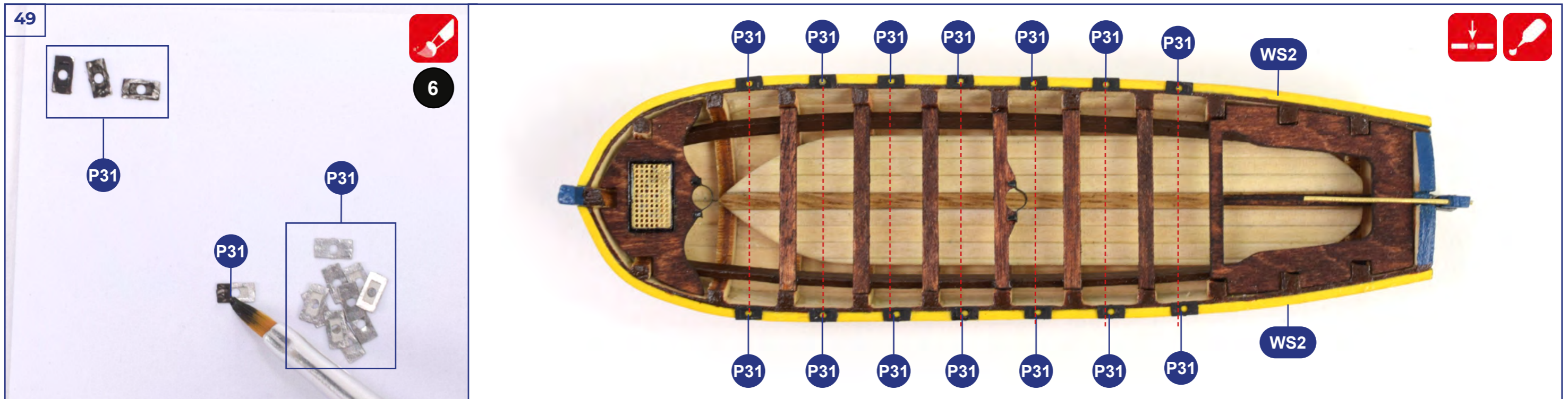
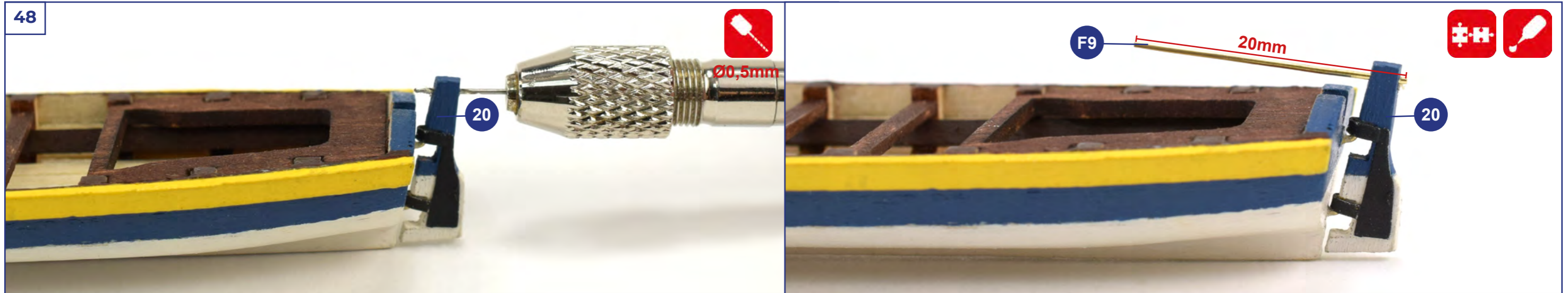

51

R

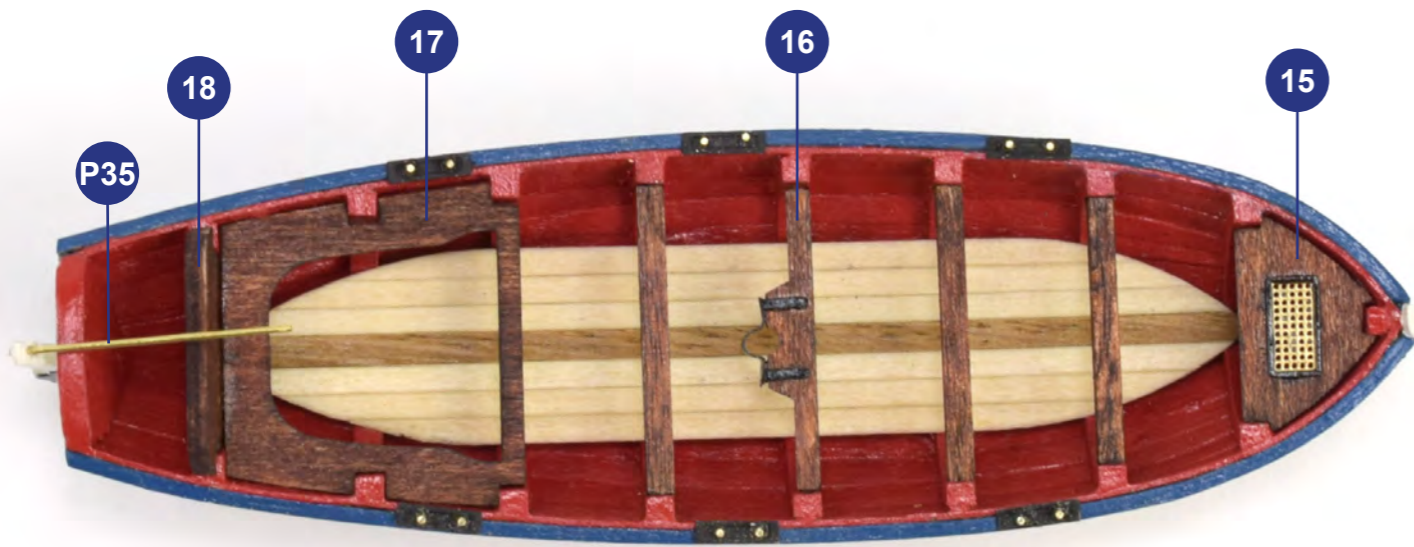
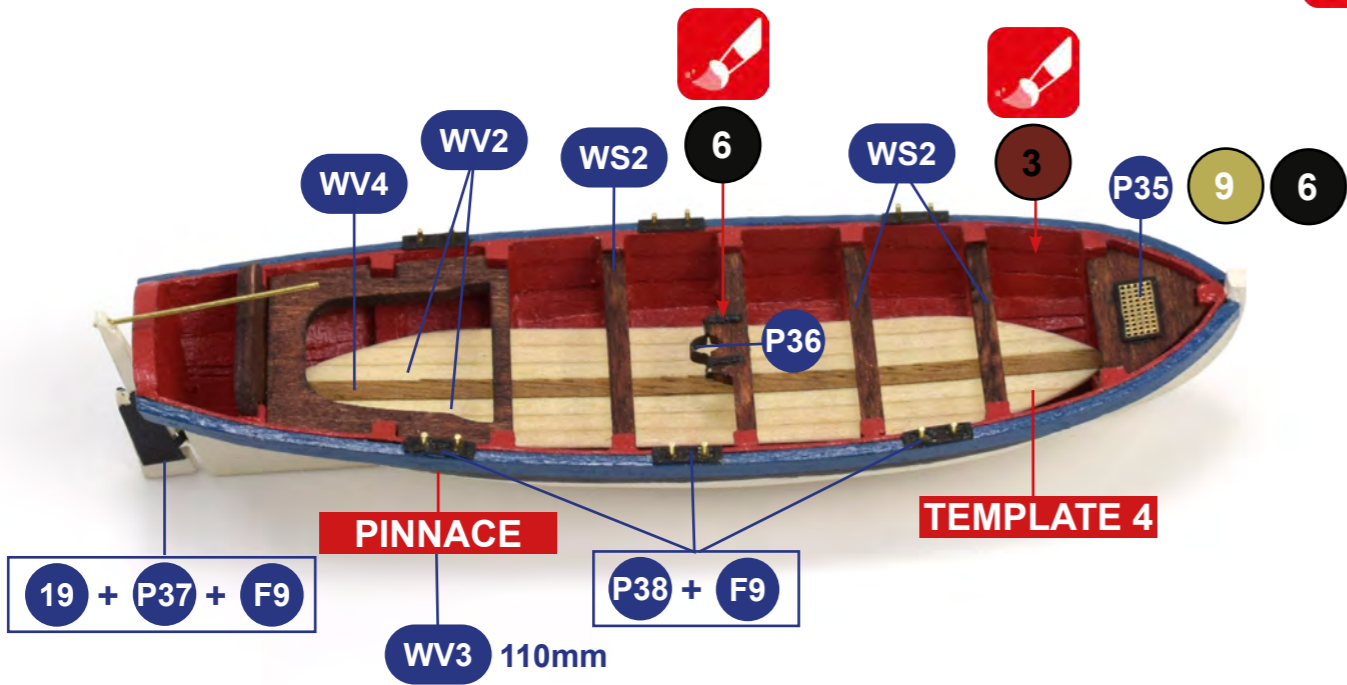

52

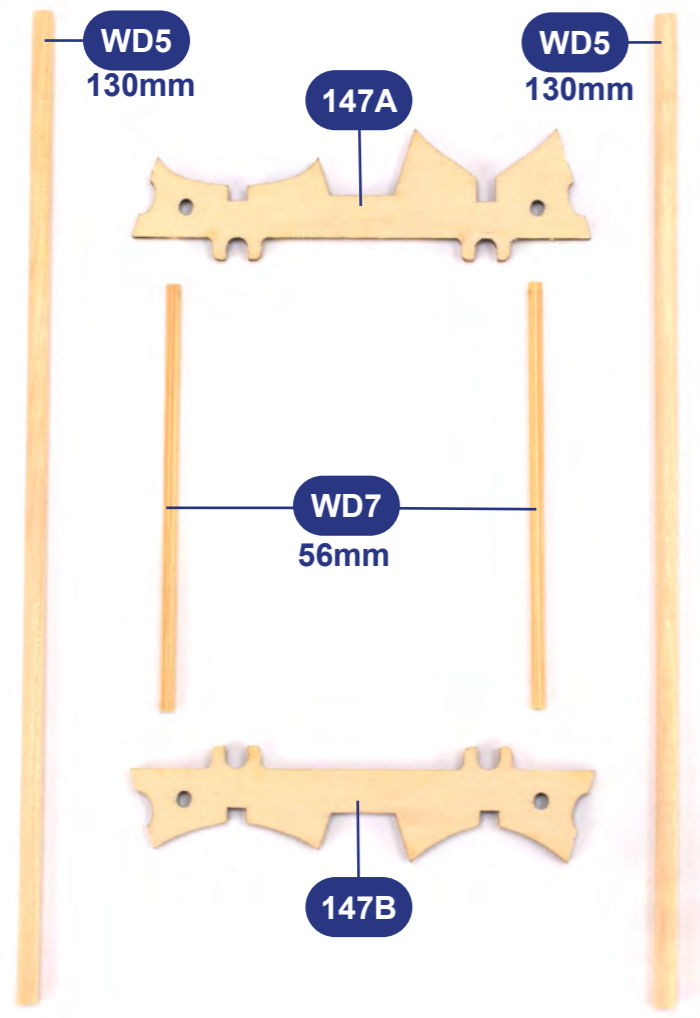

53

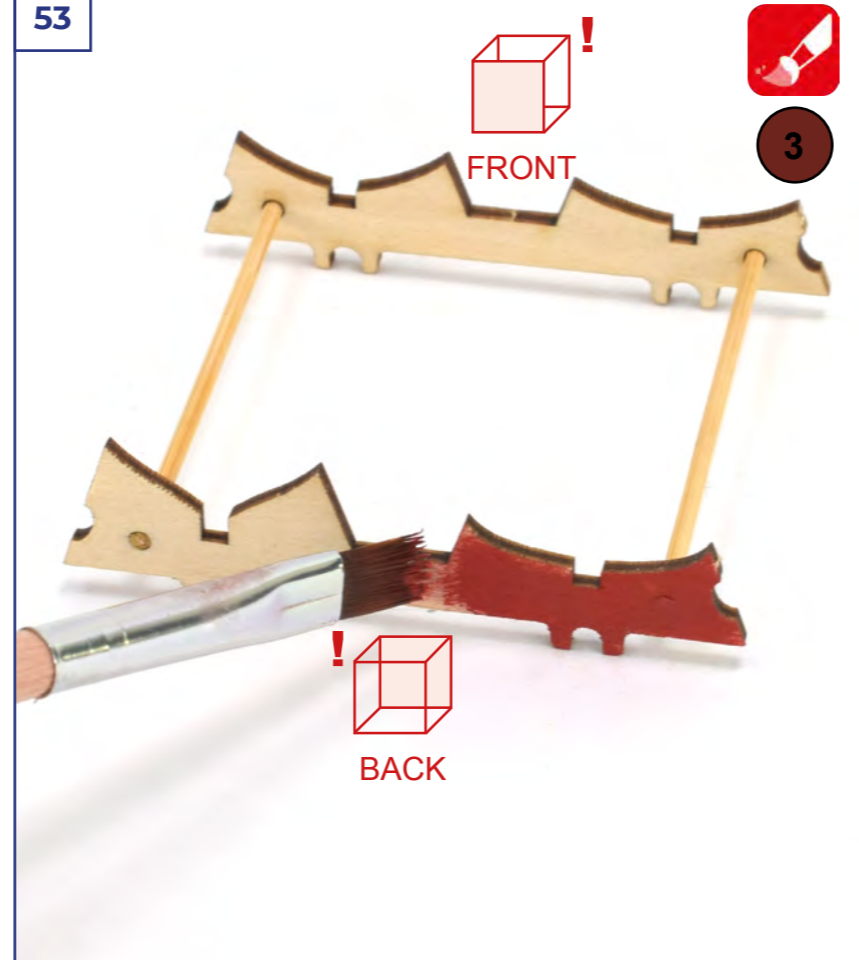

54

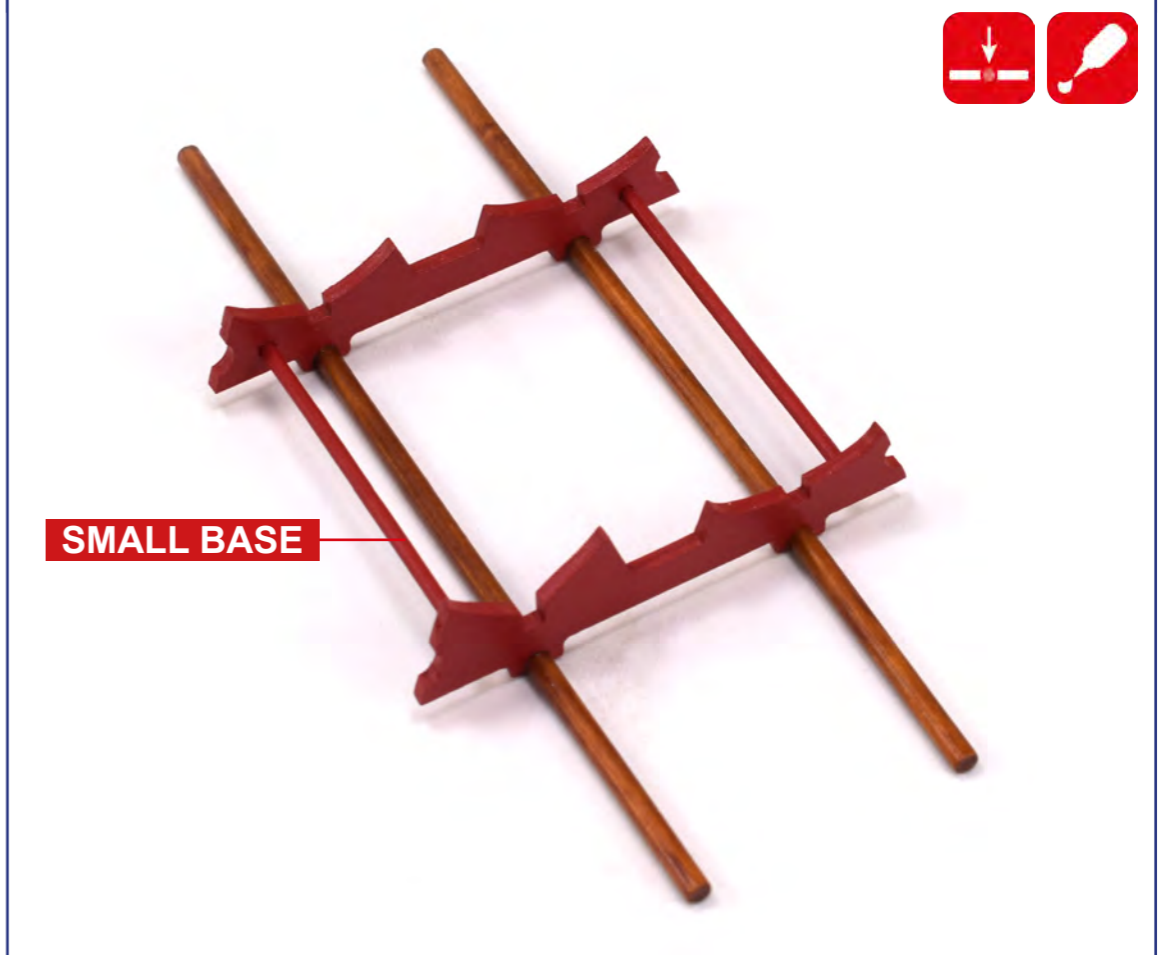
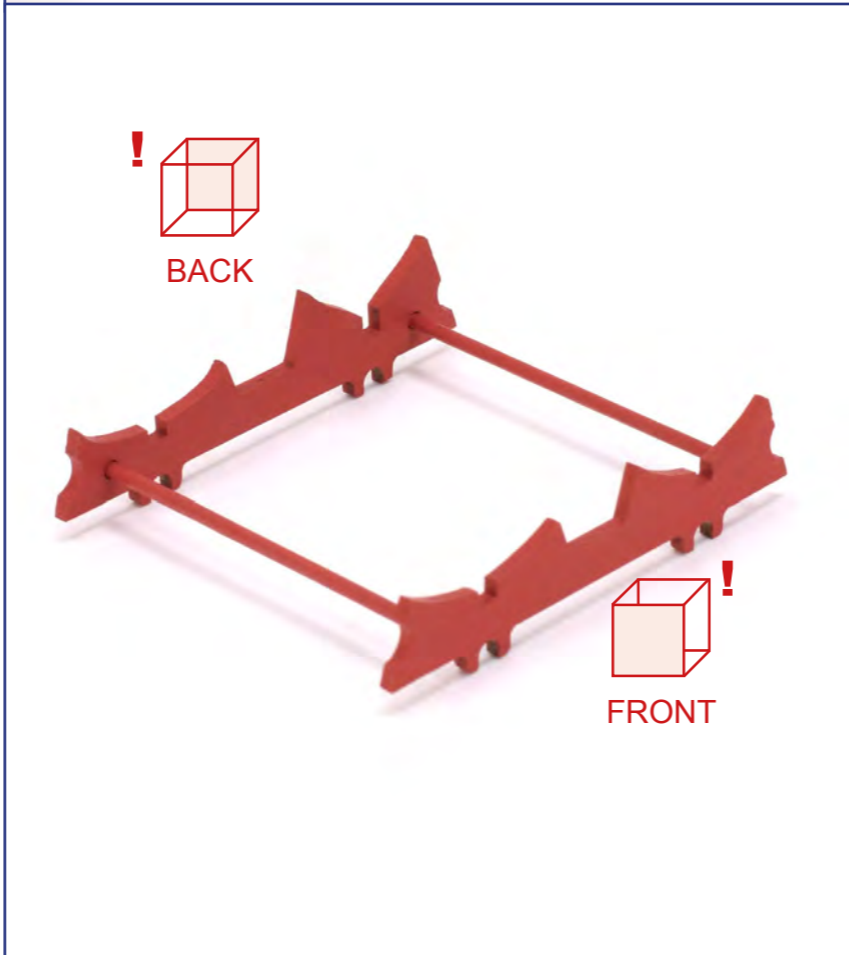
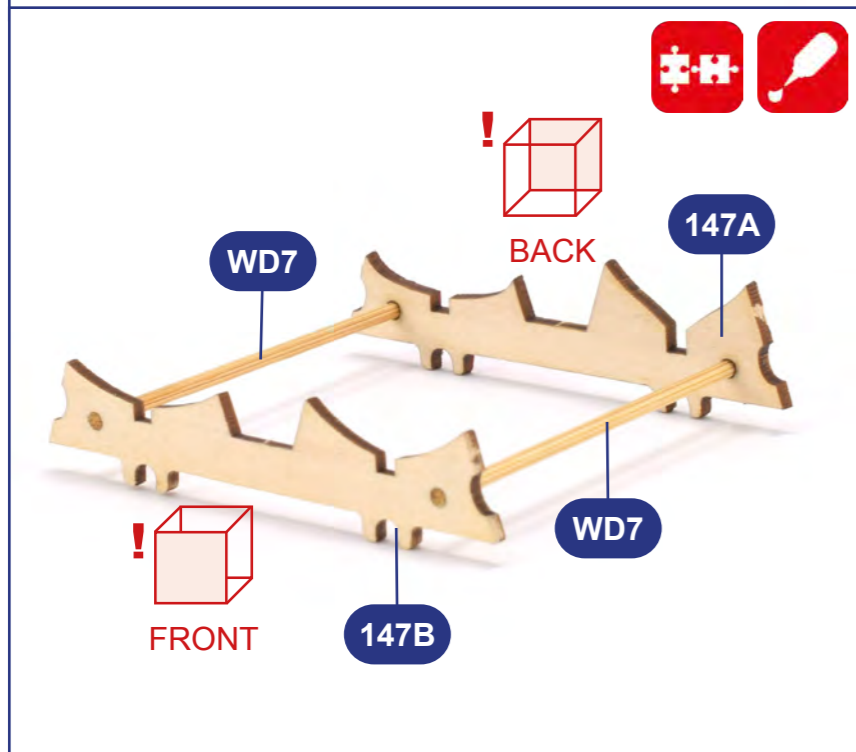
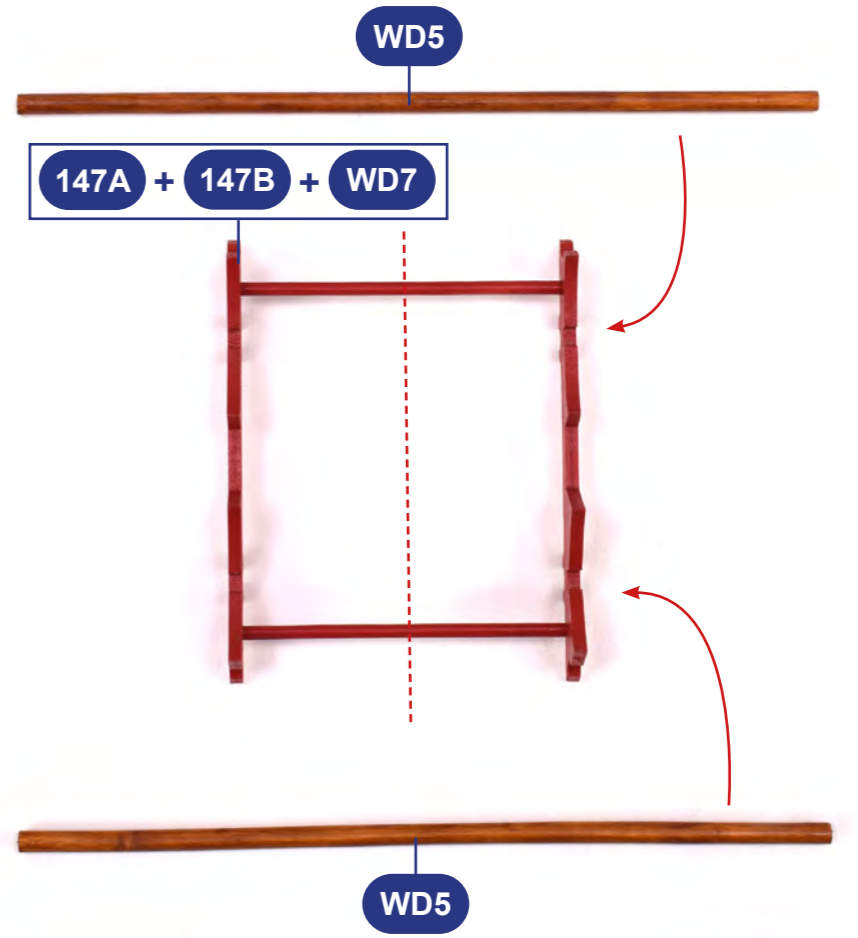



56



57



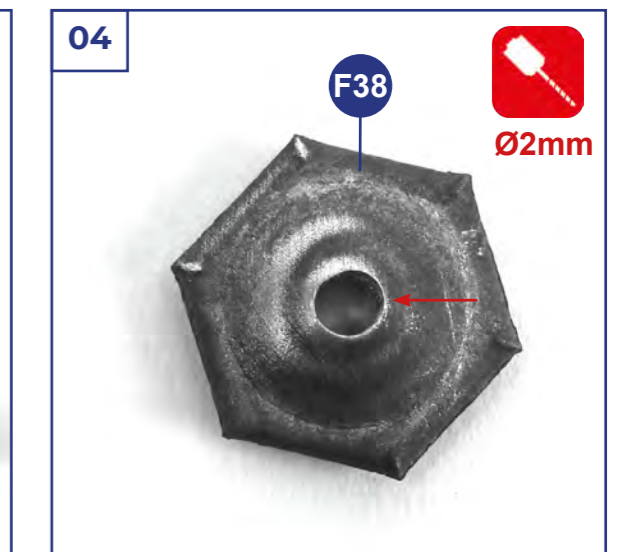
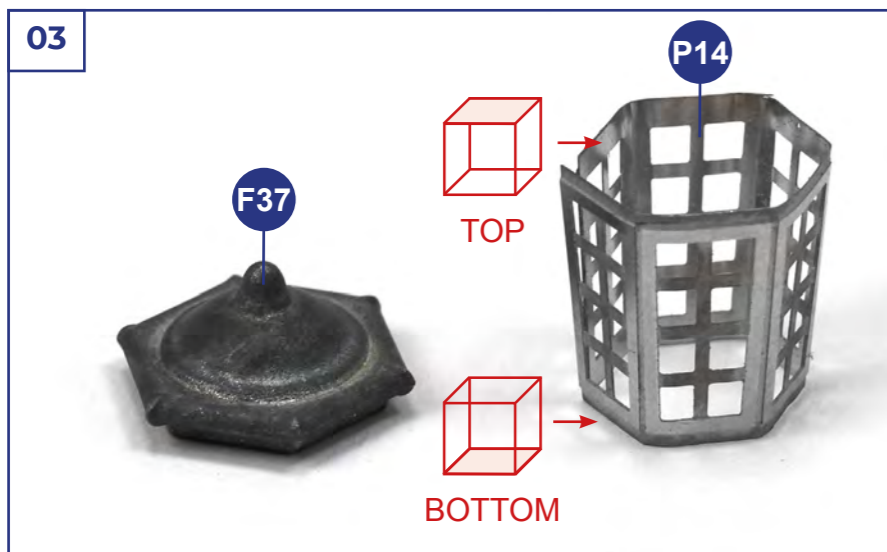
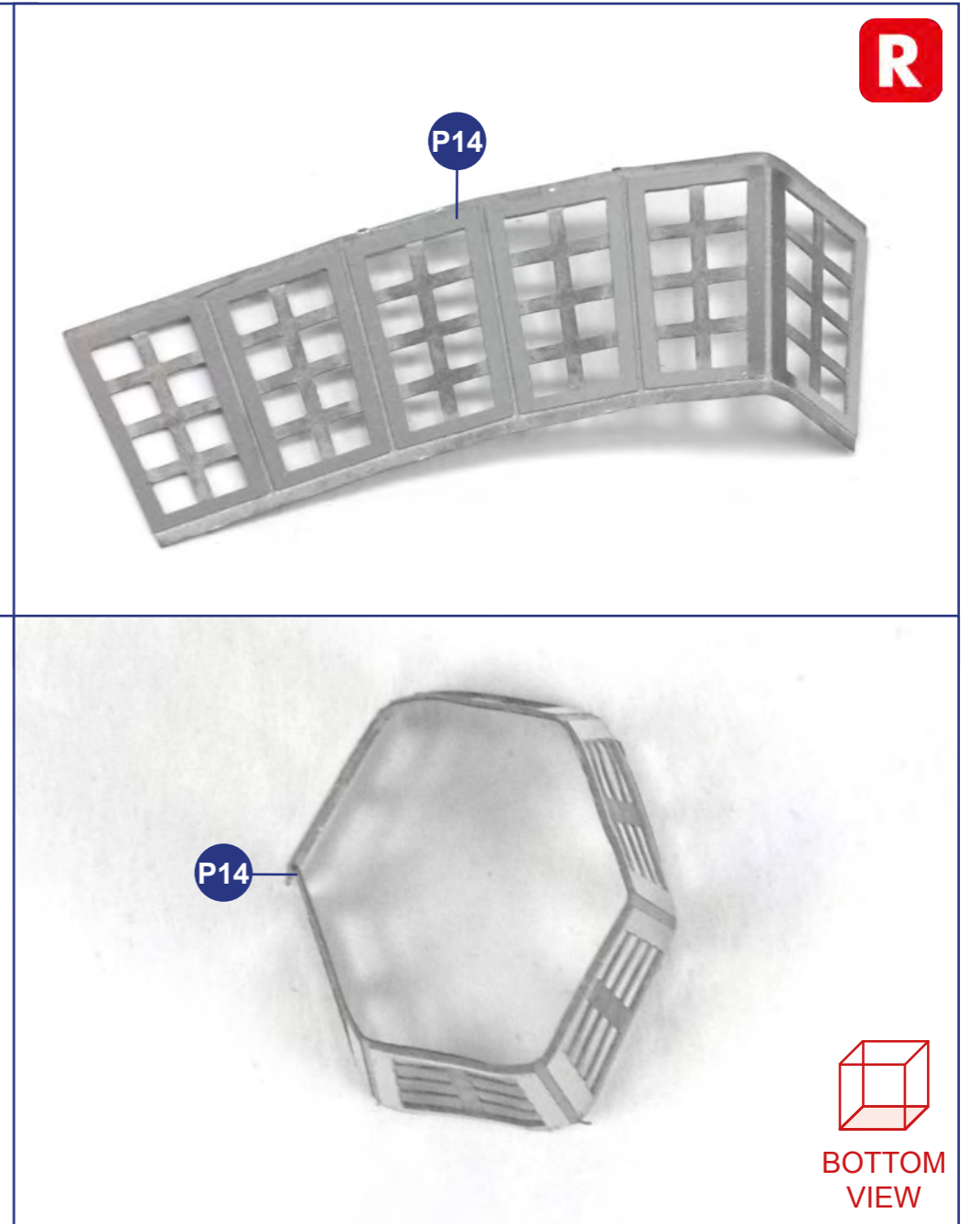
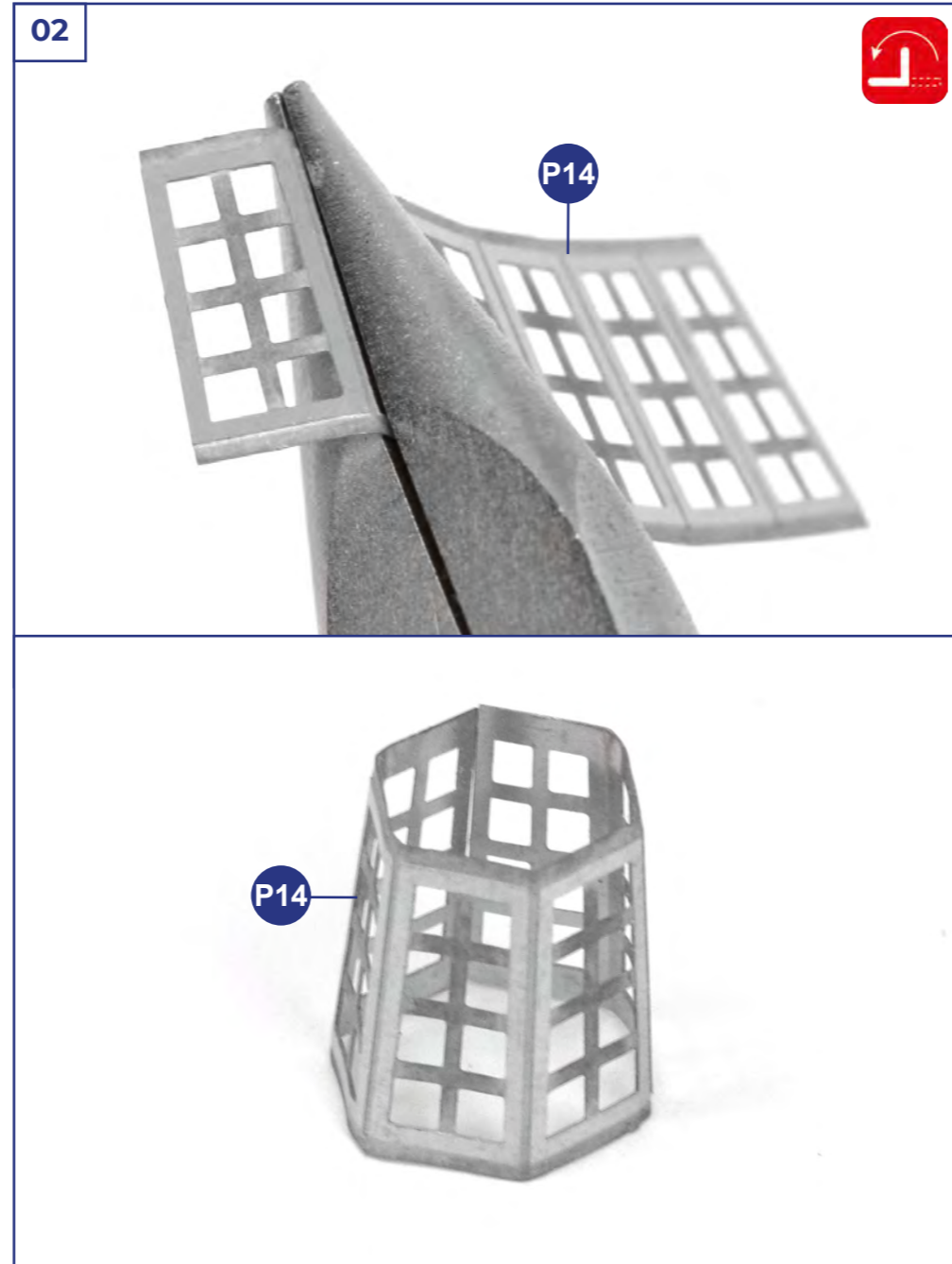
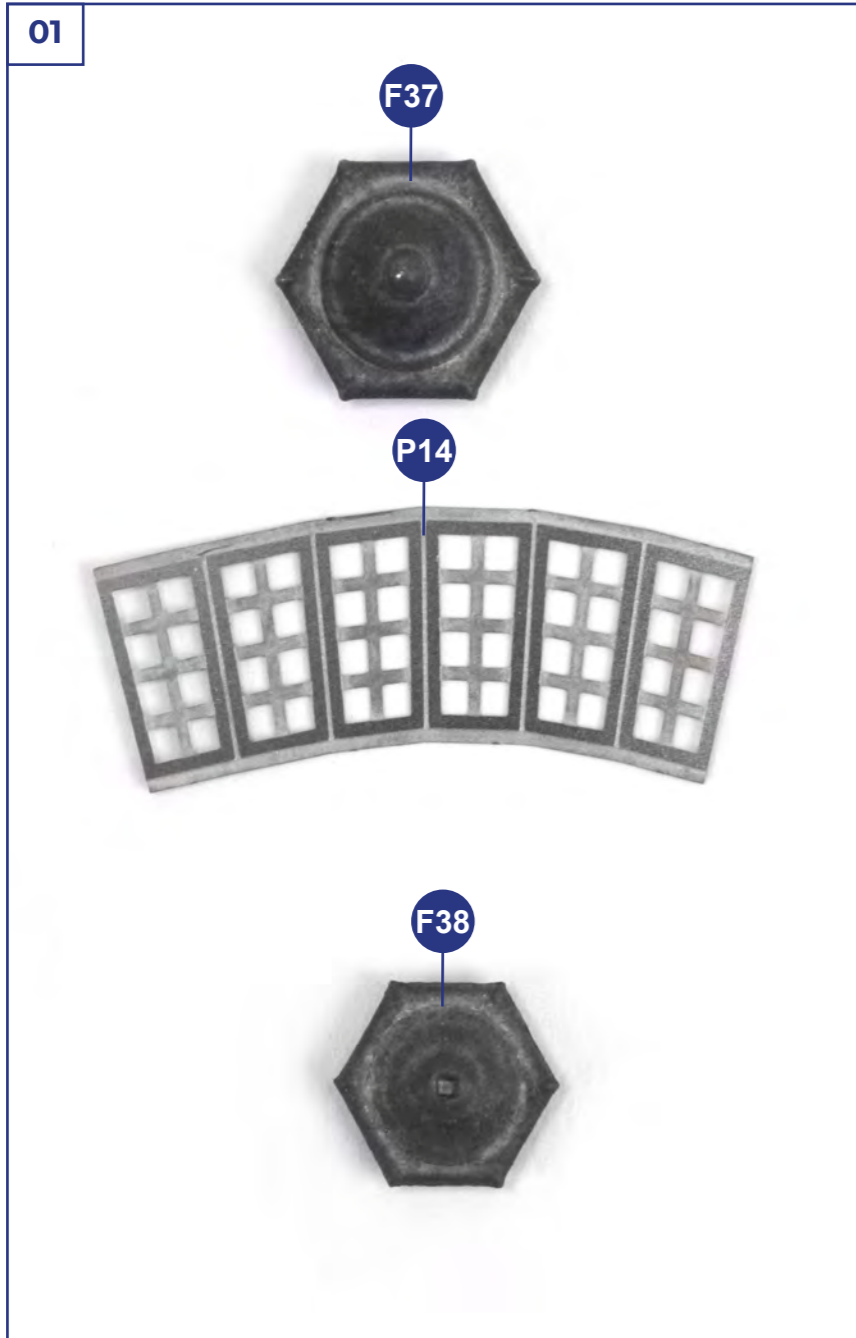

05



06

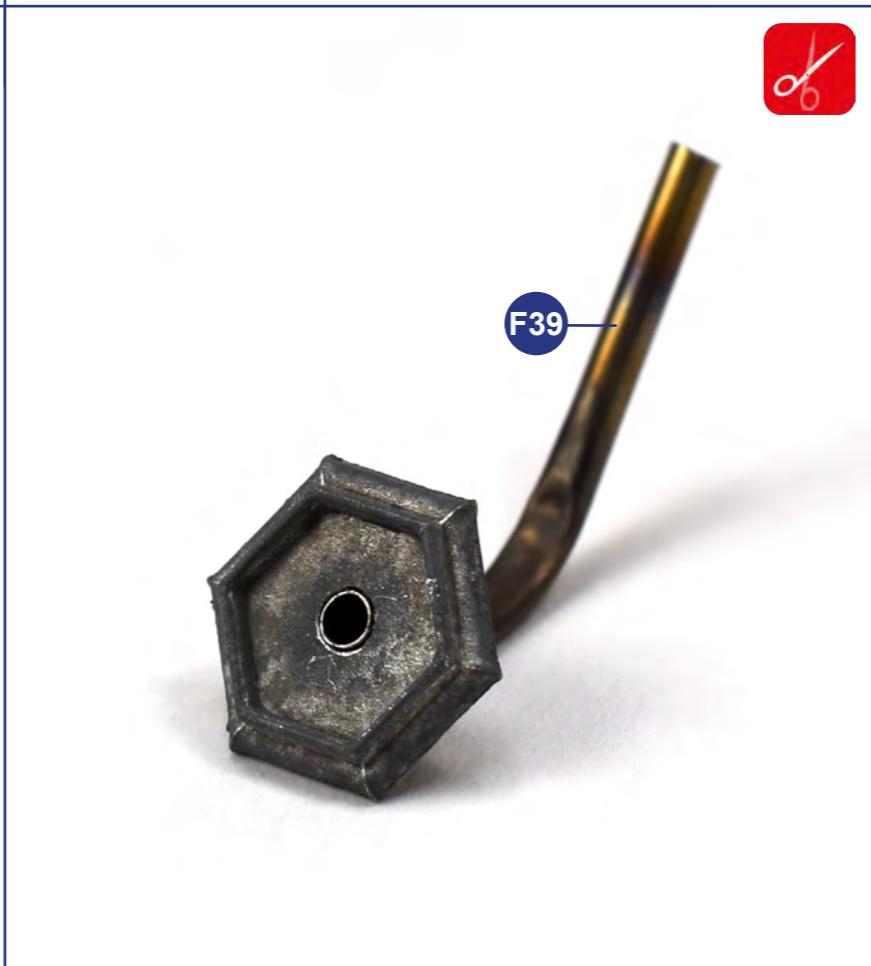
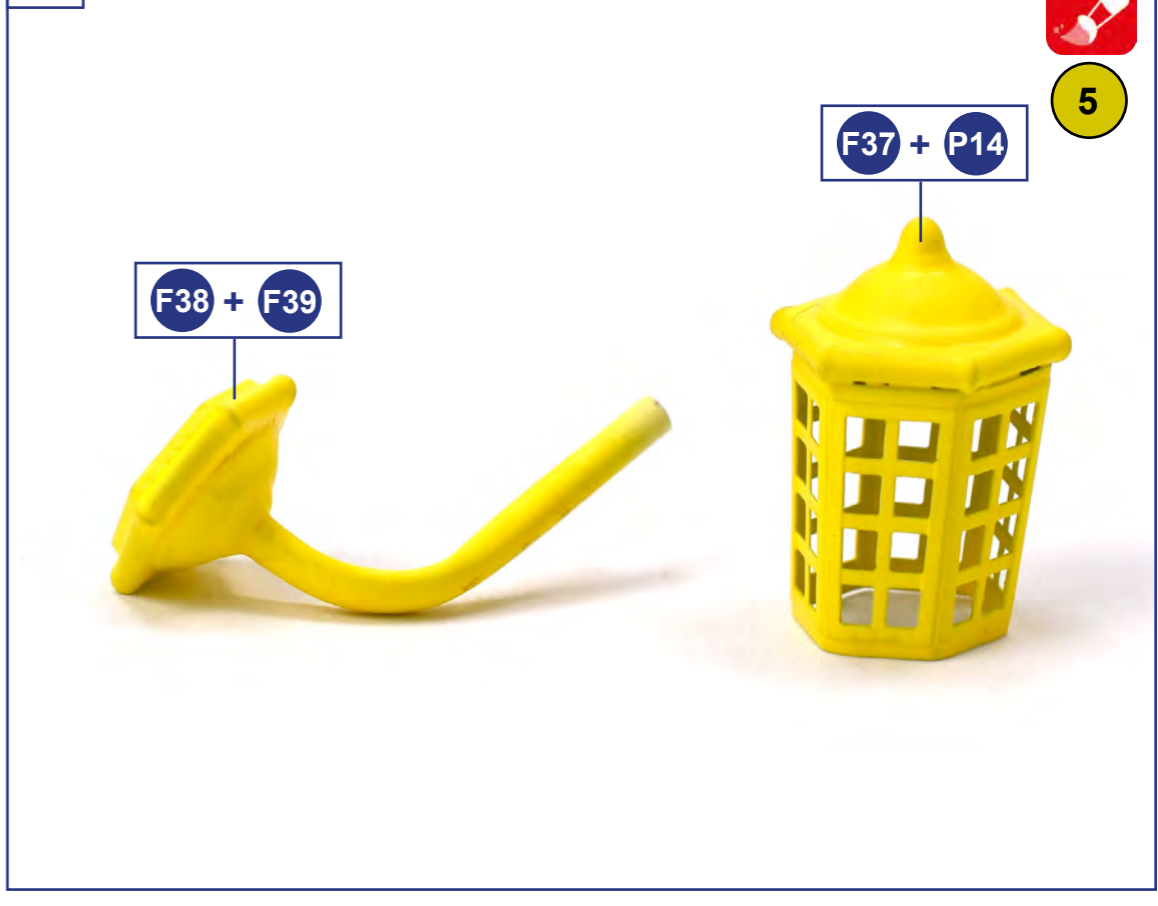

07



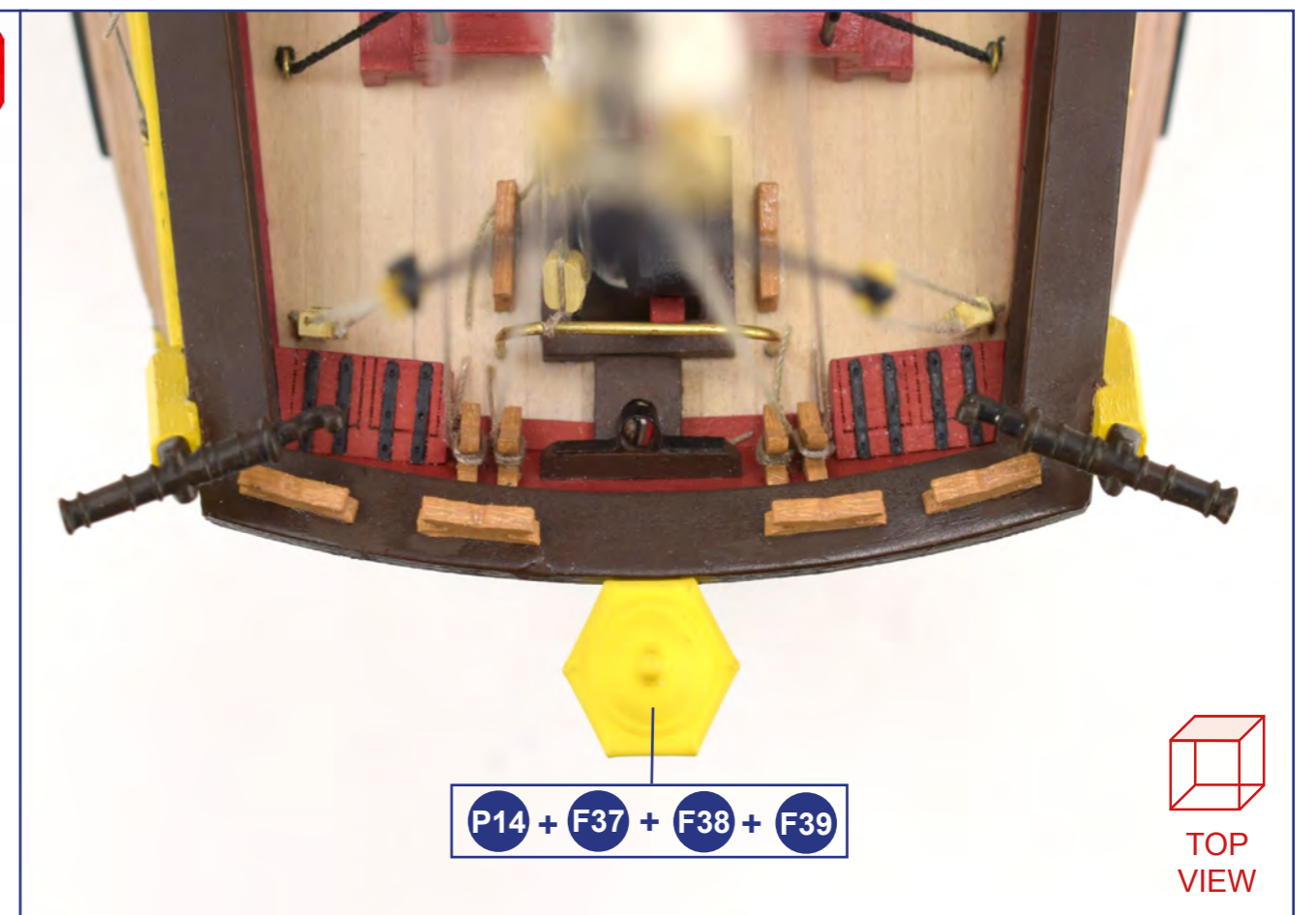
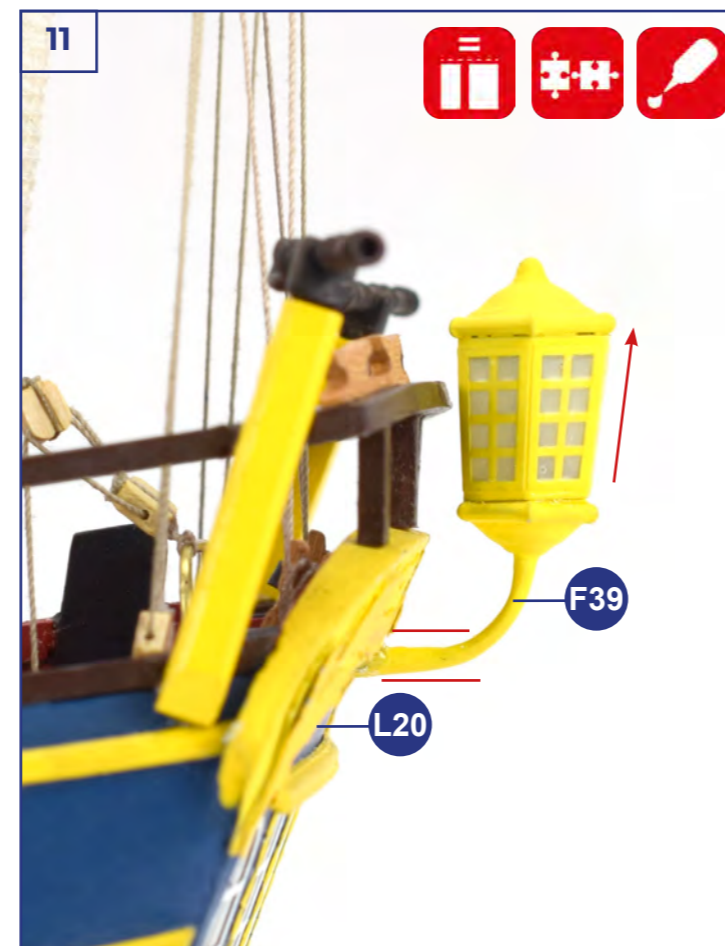
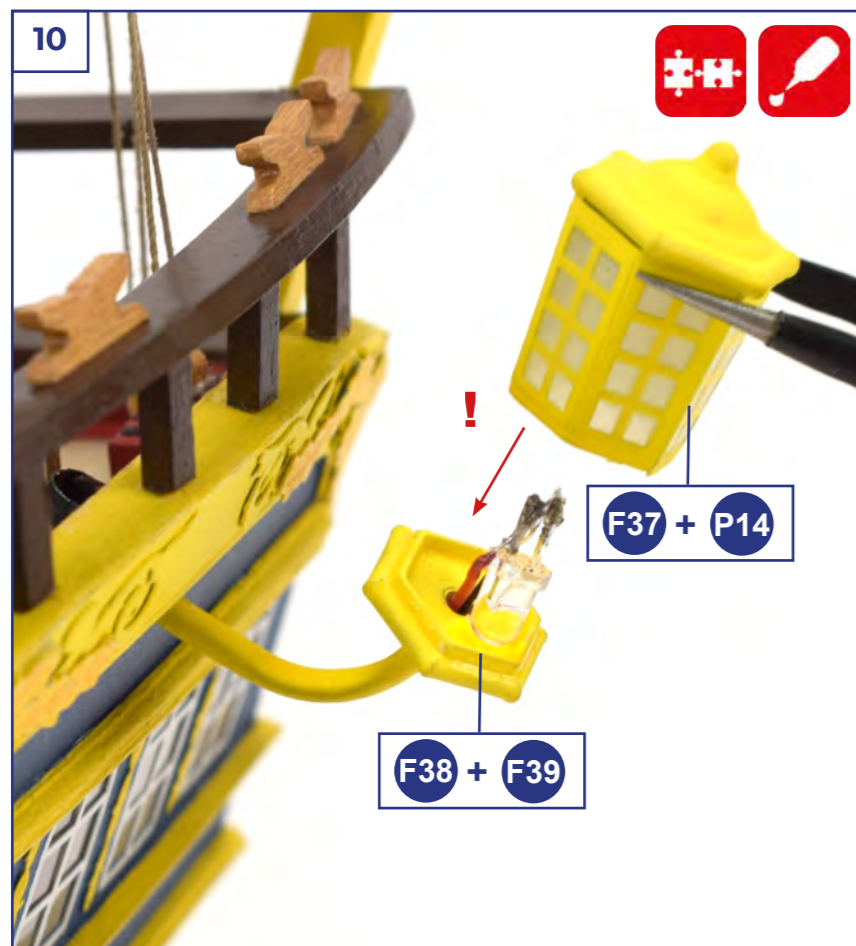
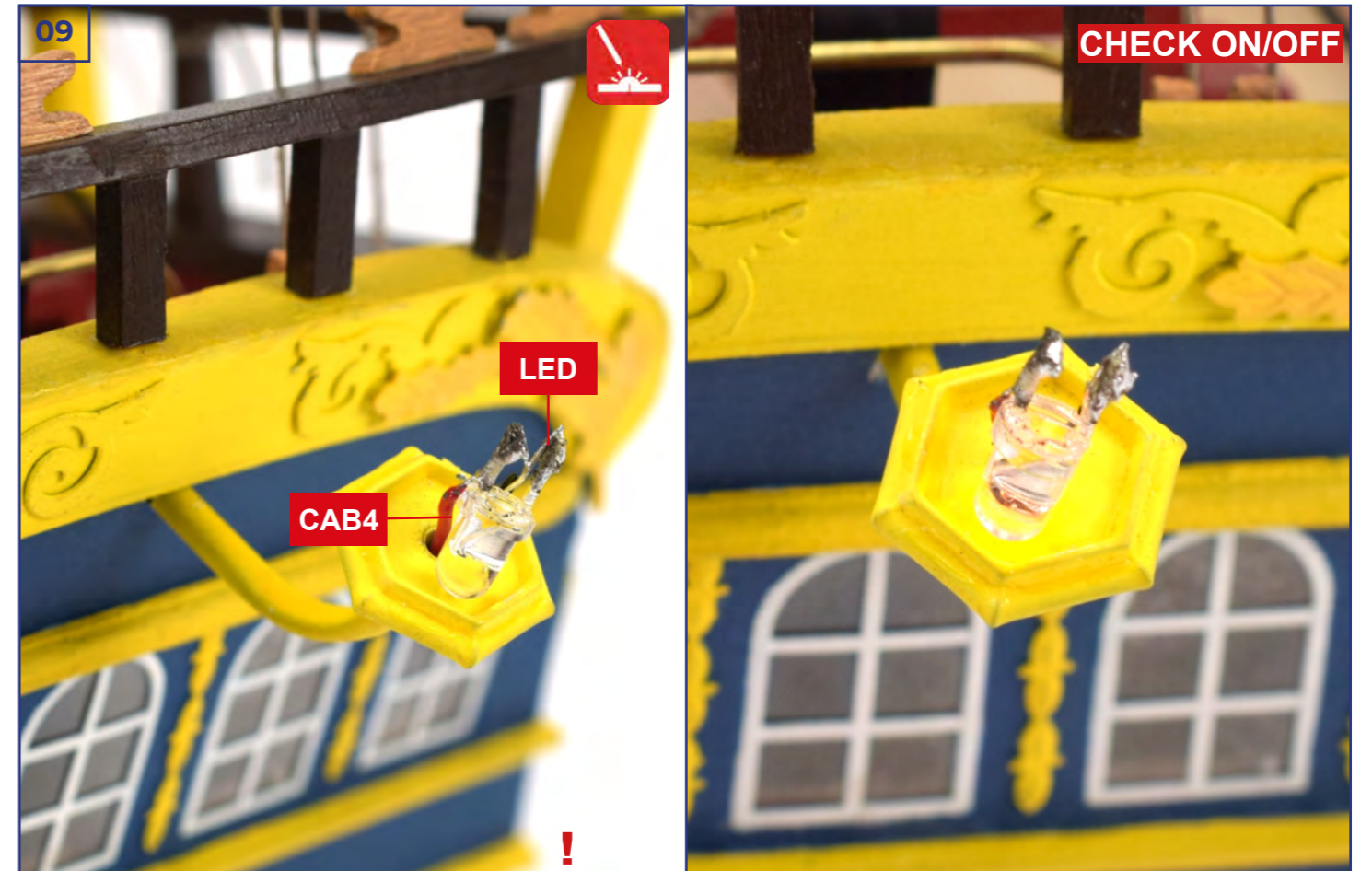
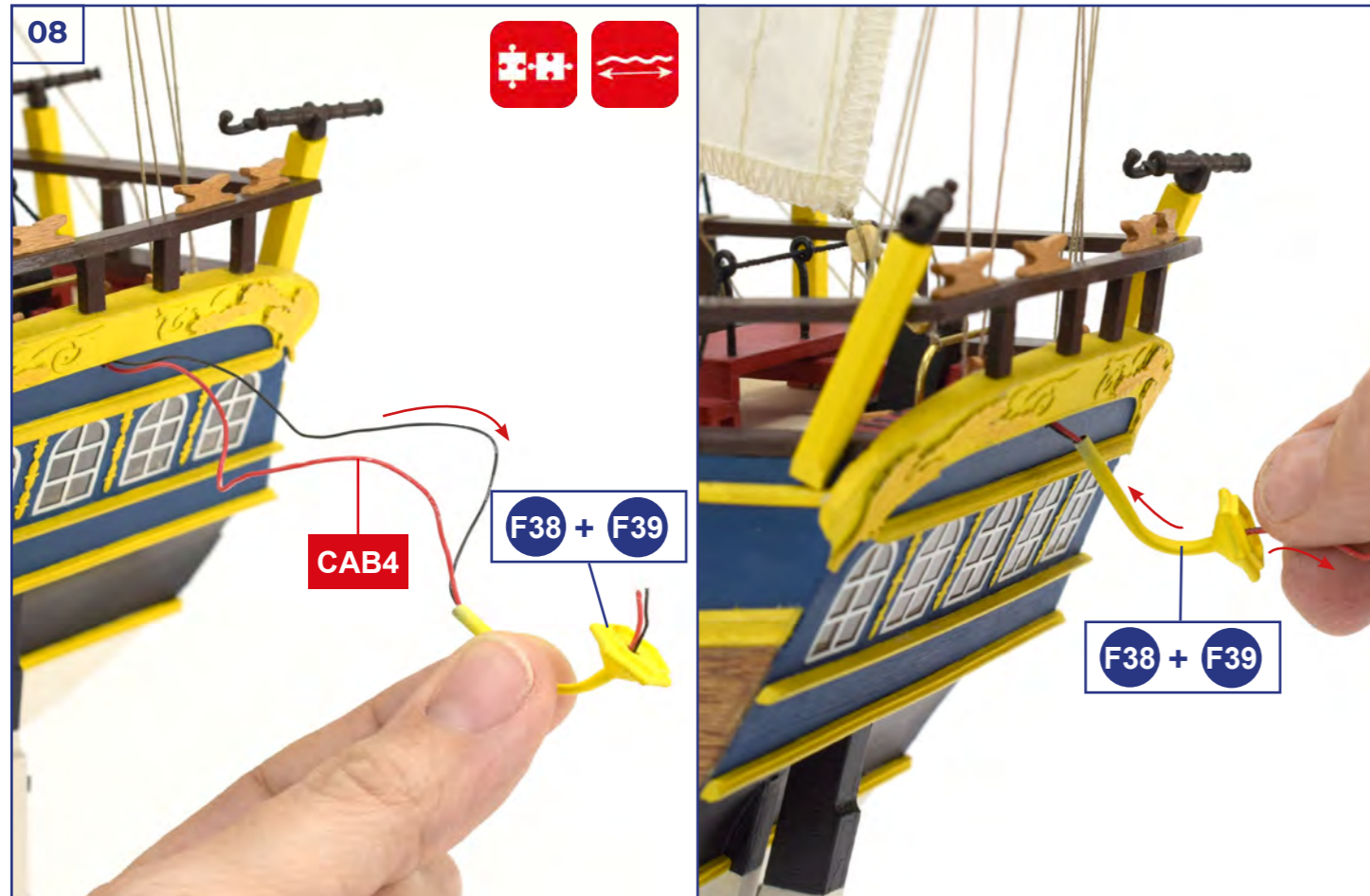

12



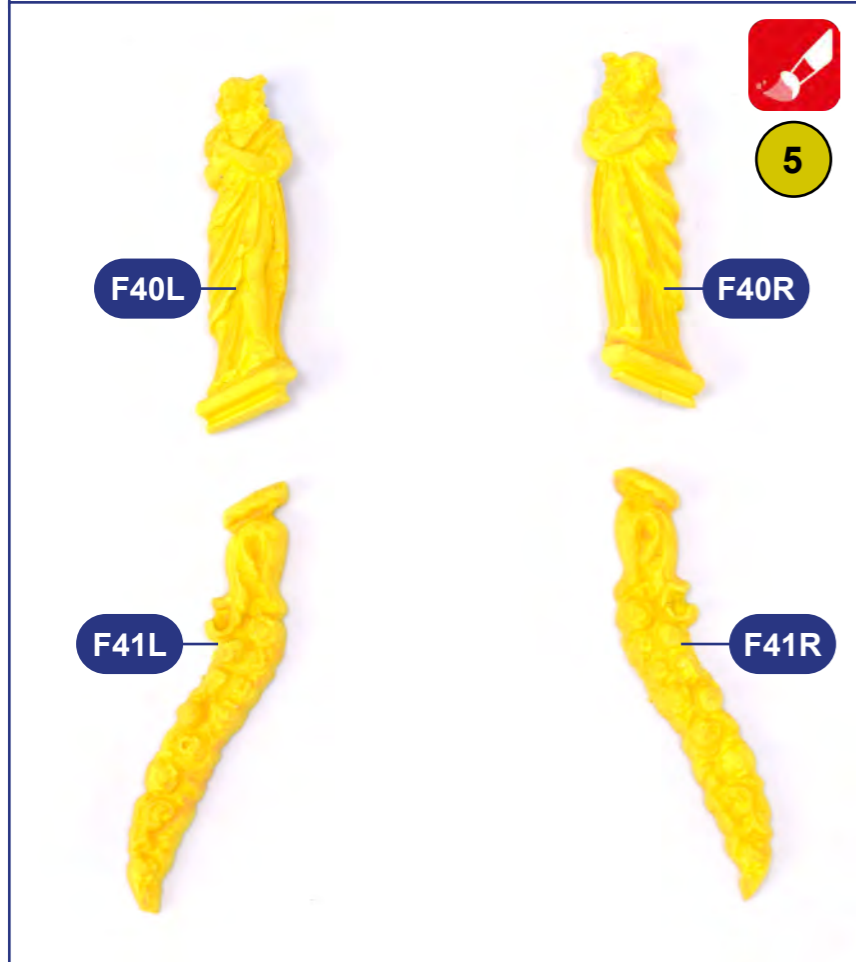
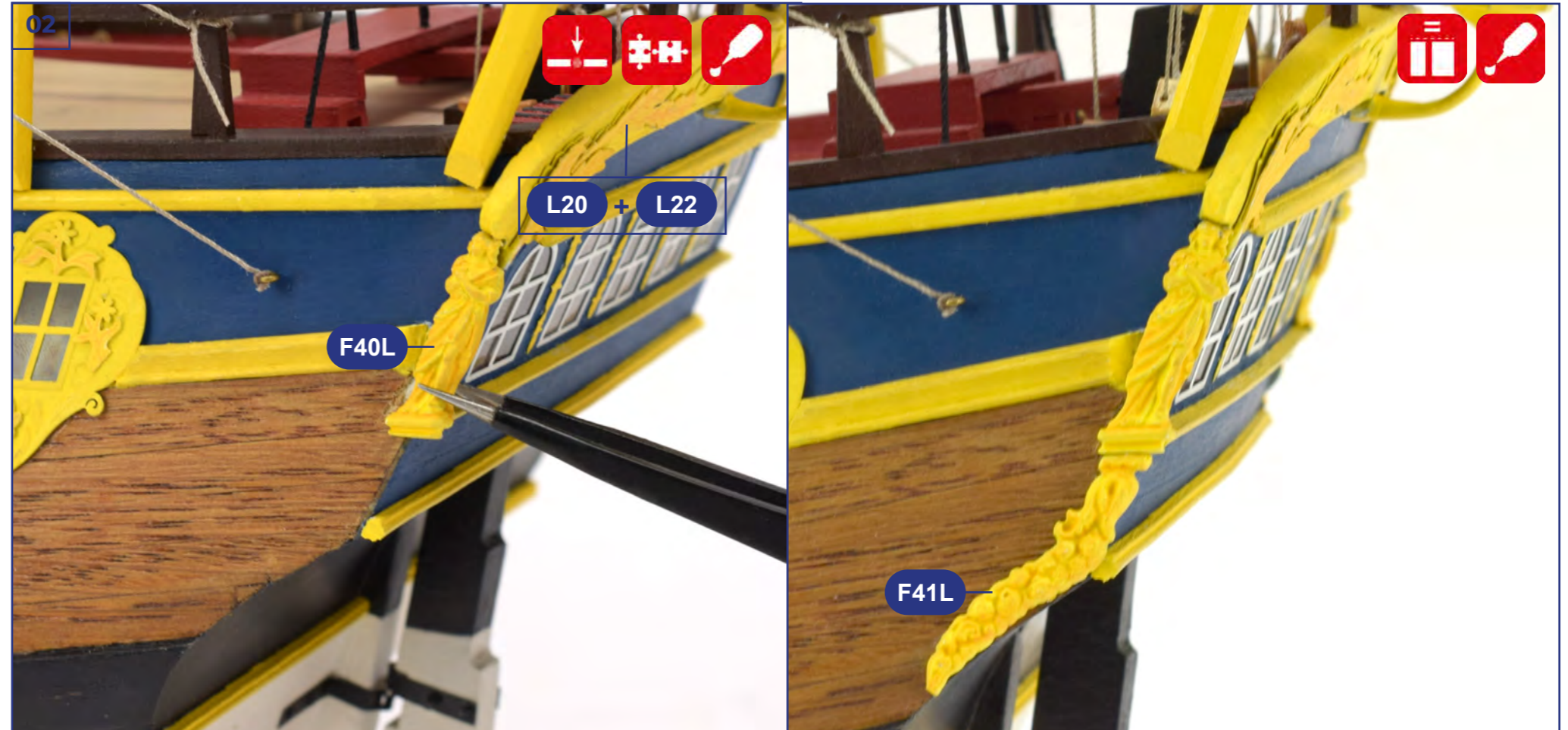



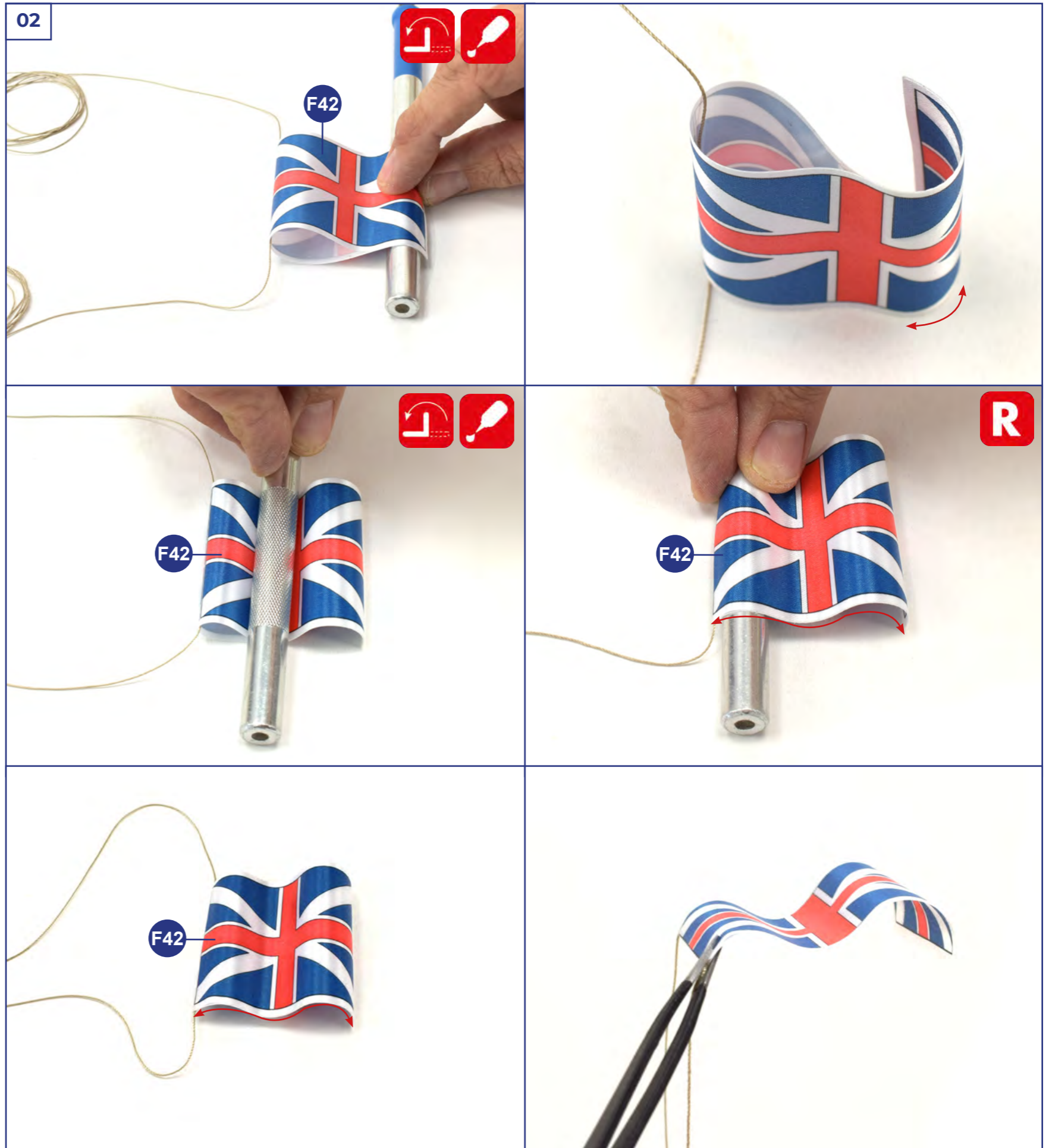
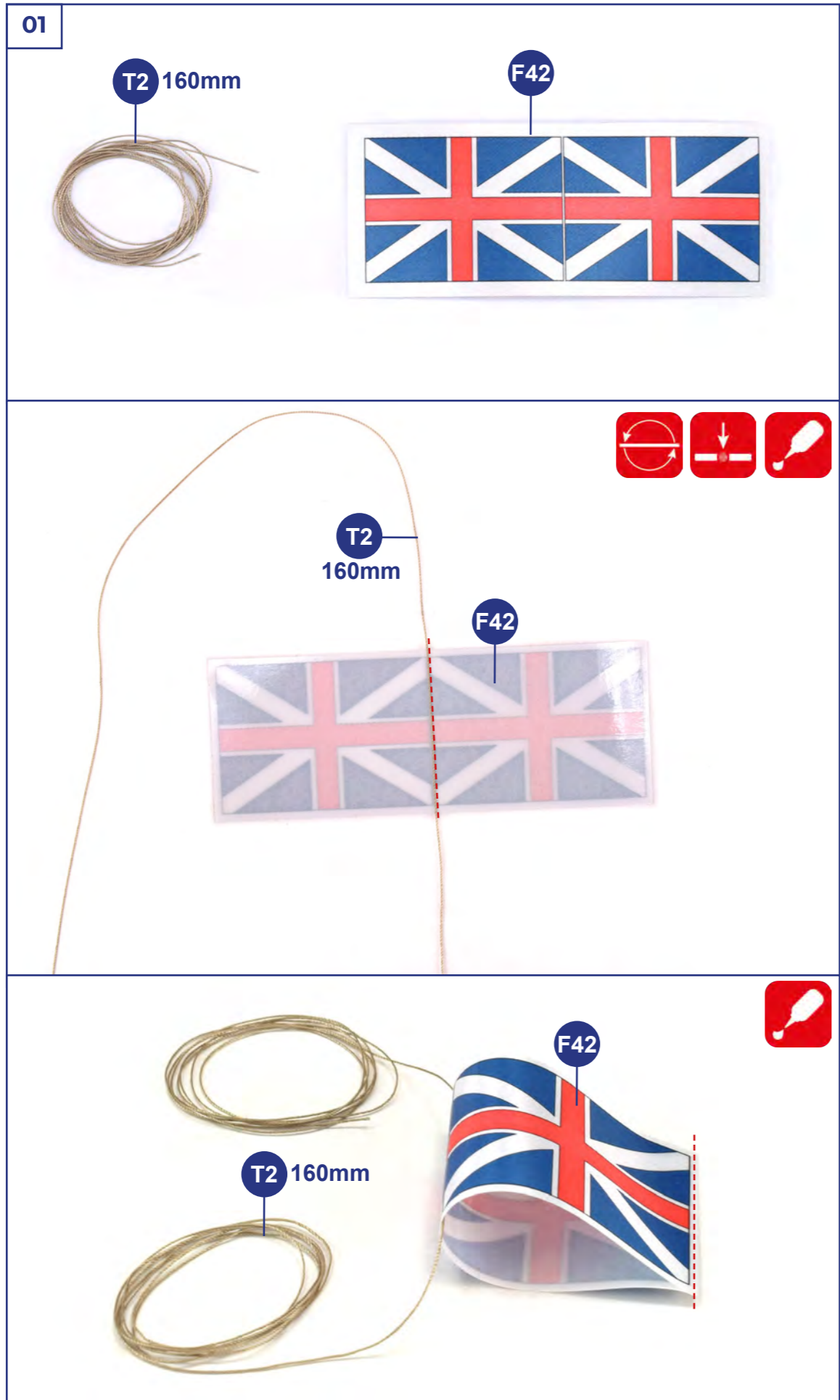

03

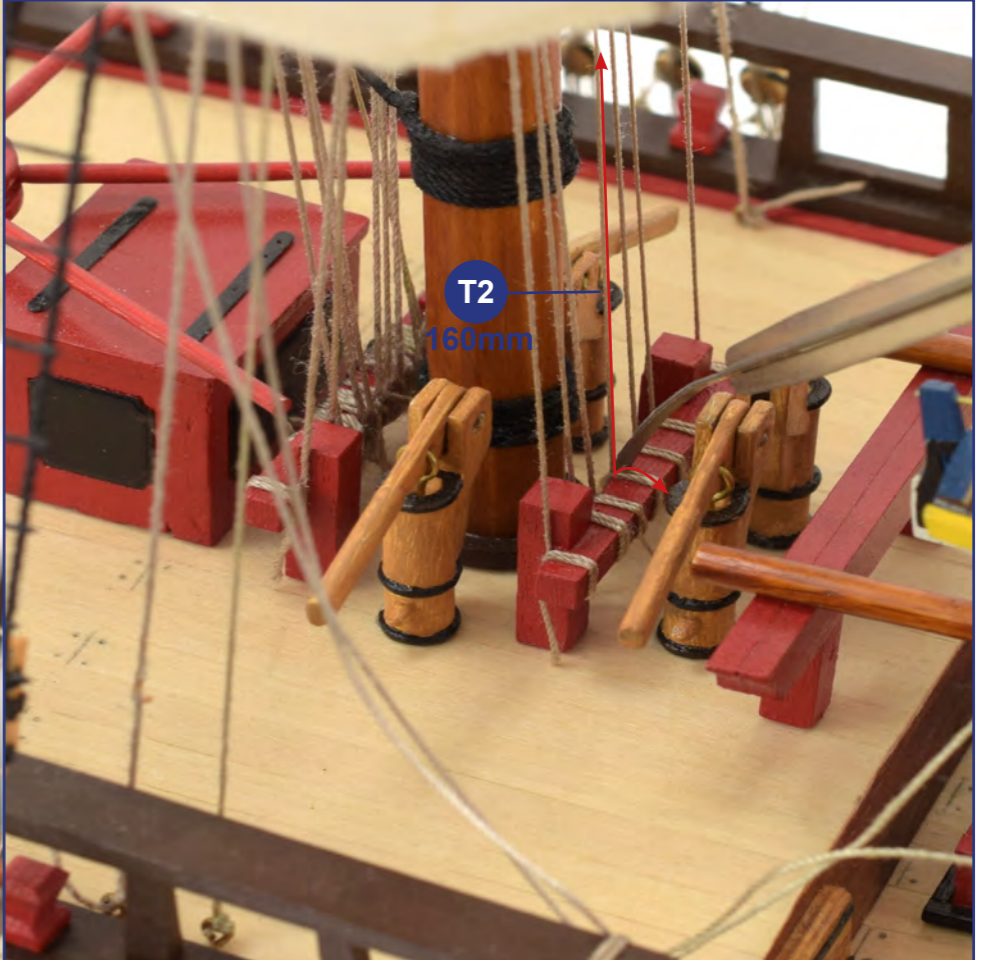
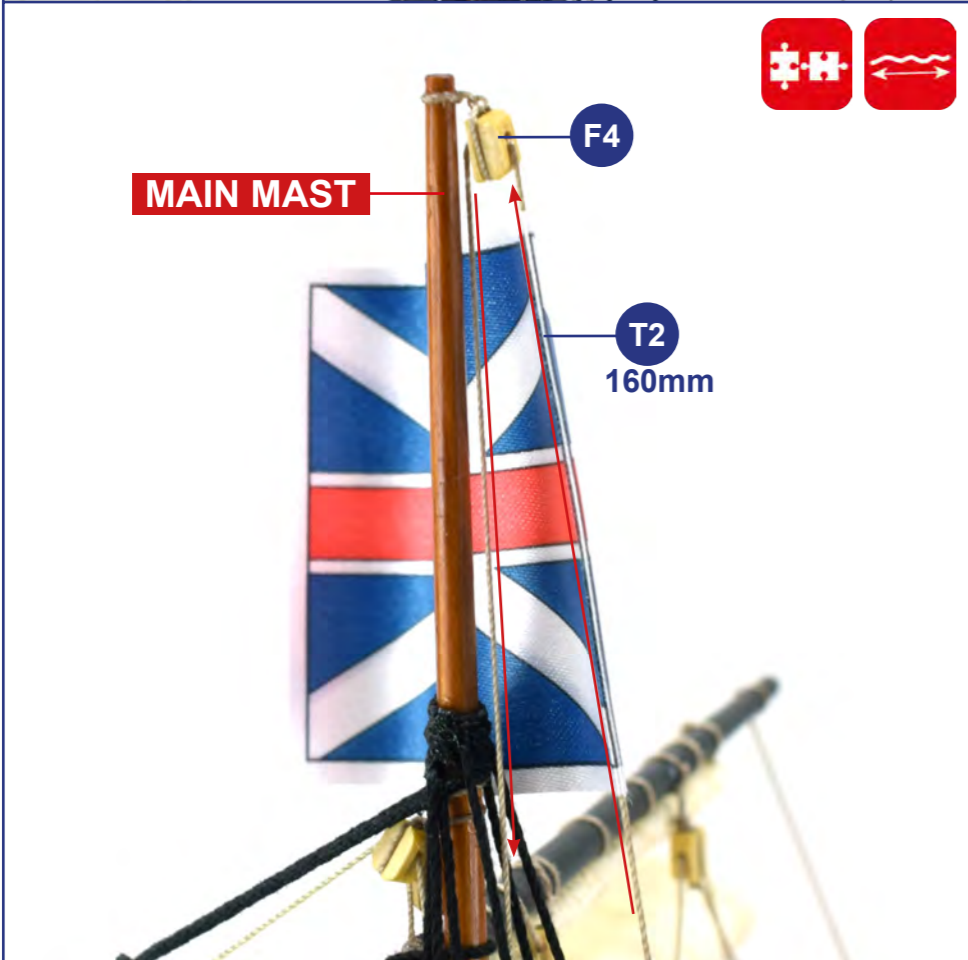
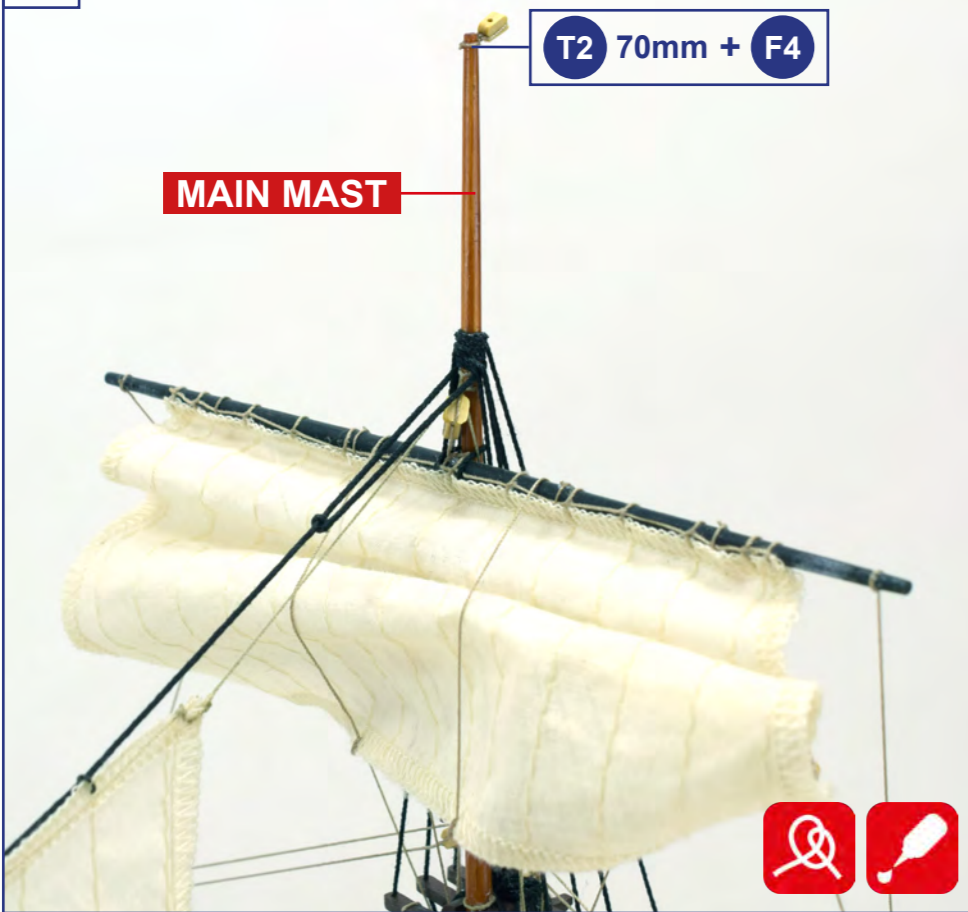

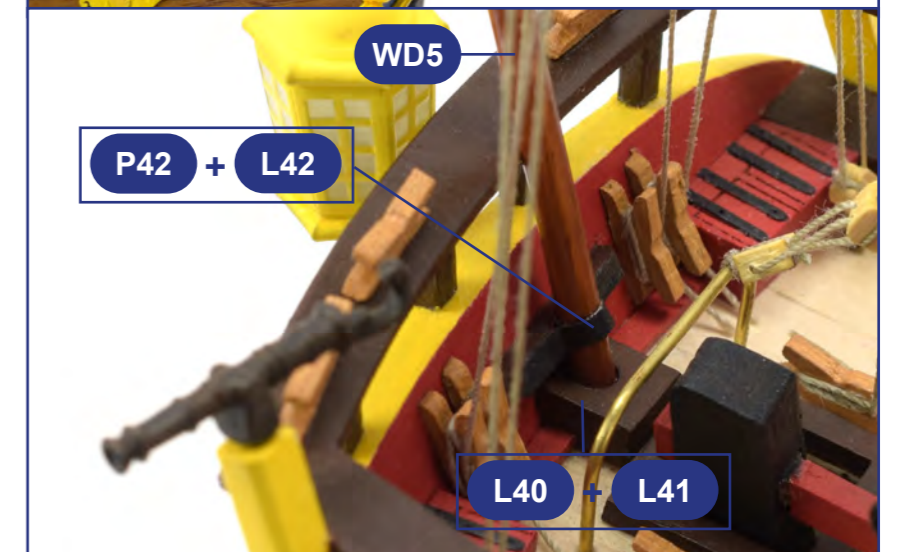
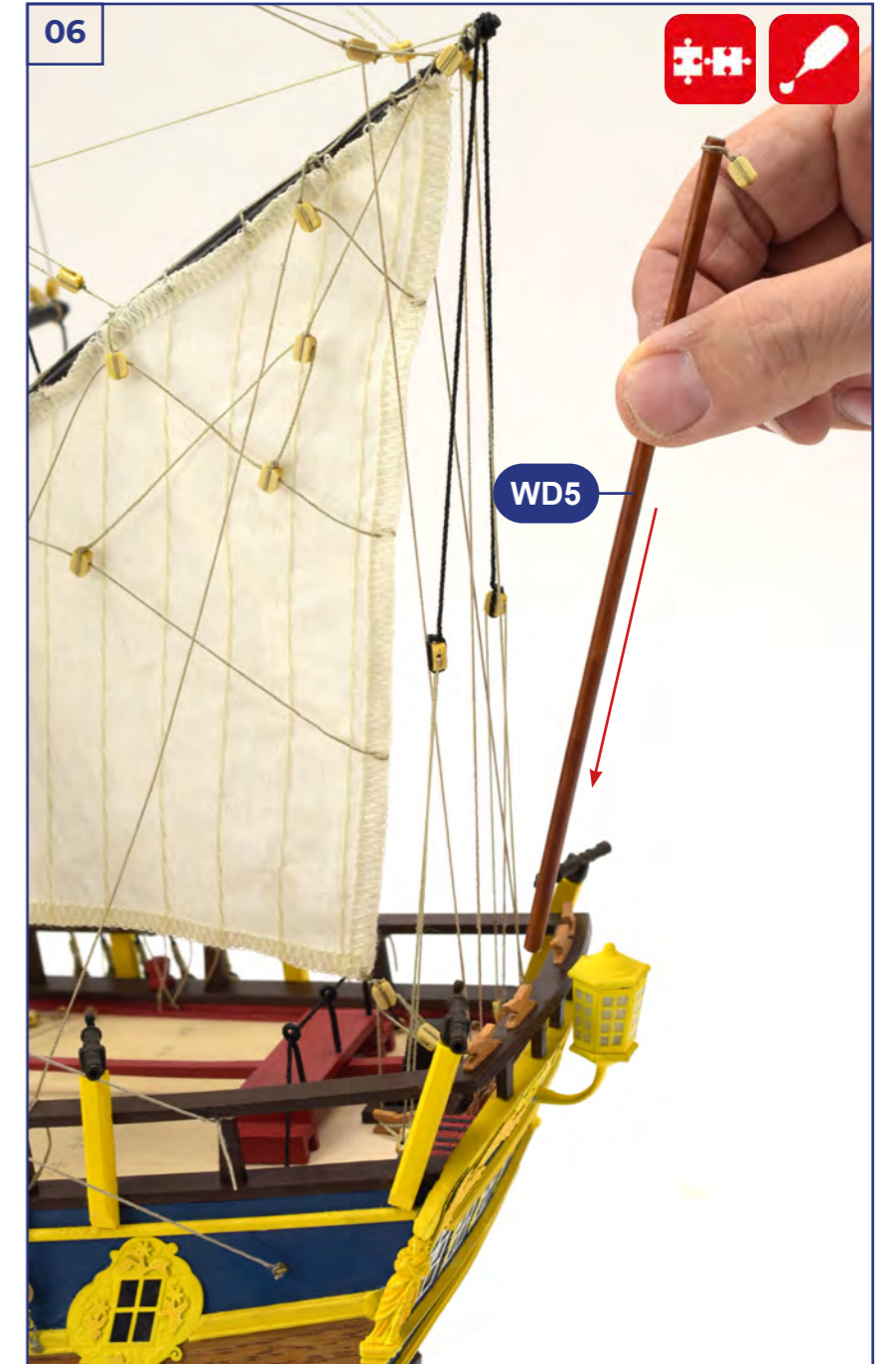
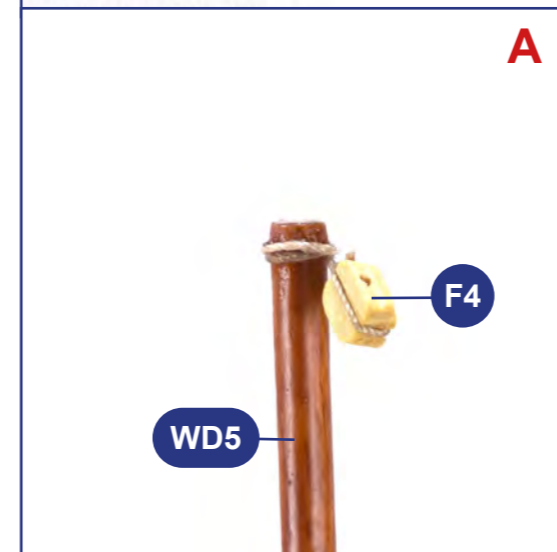
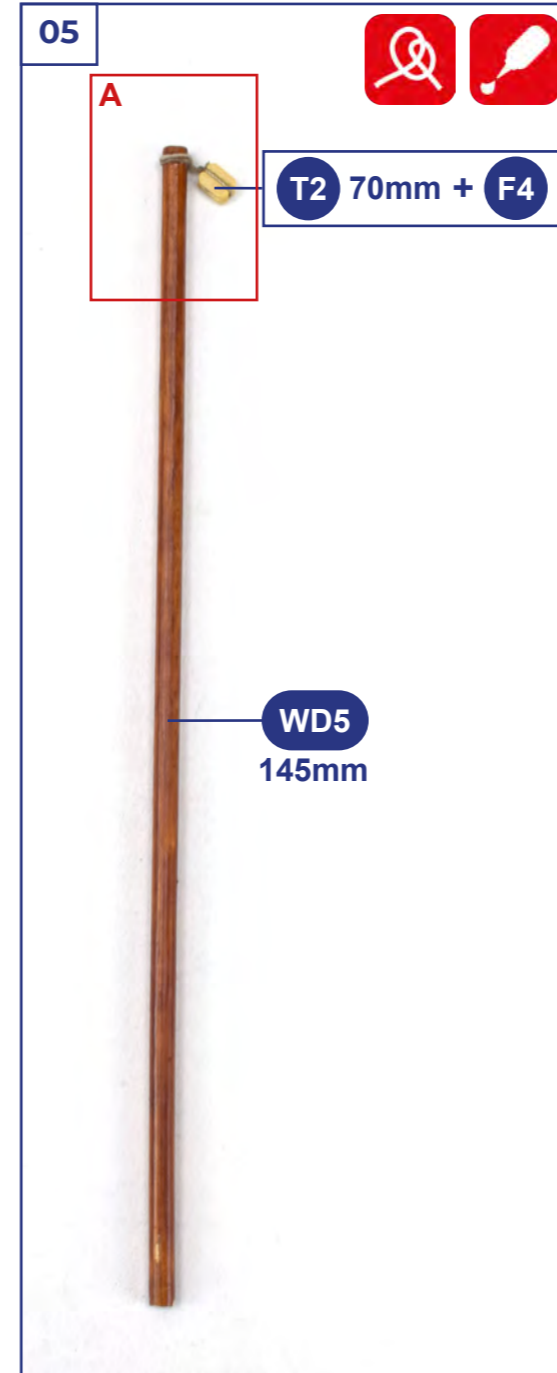
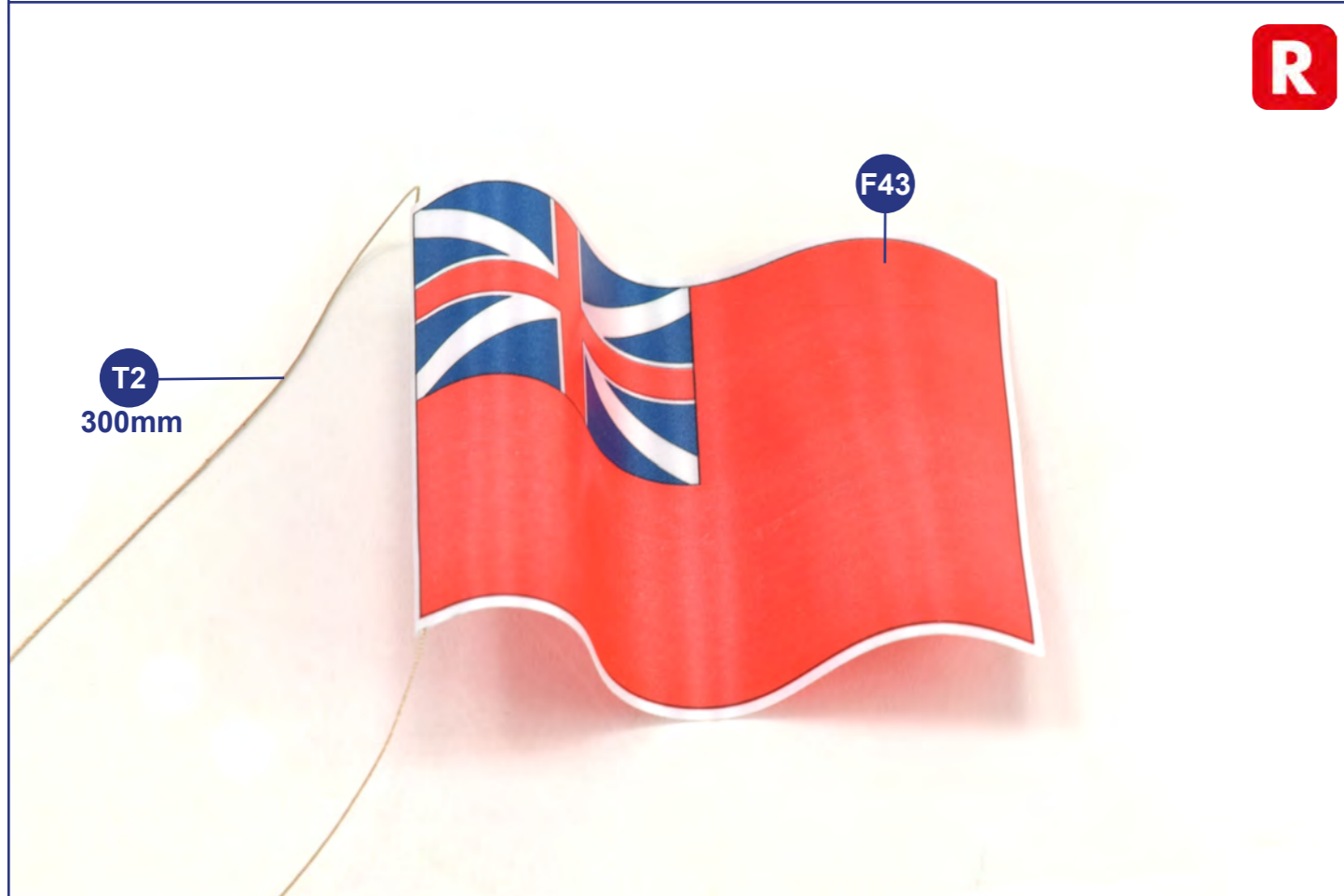
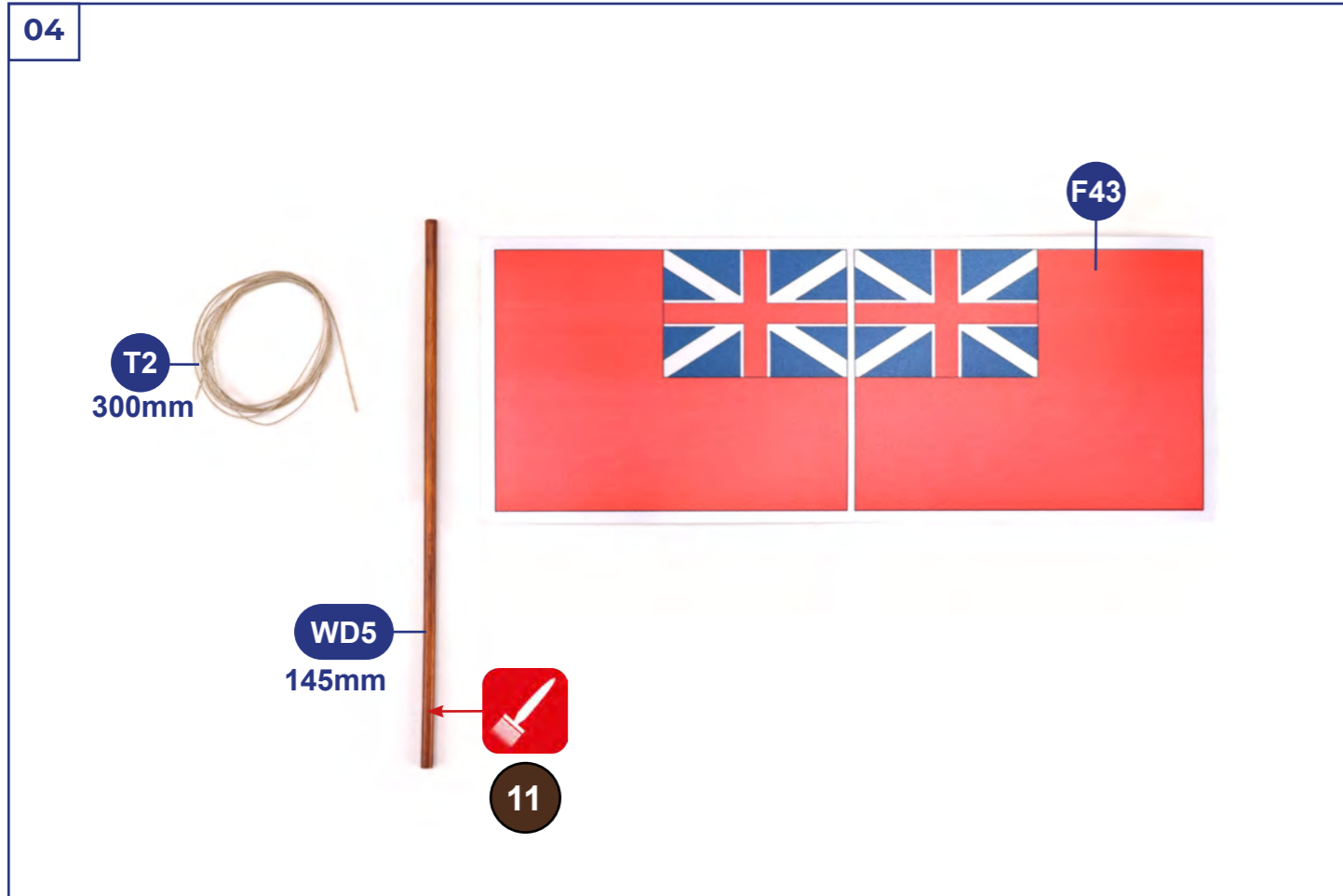

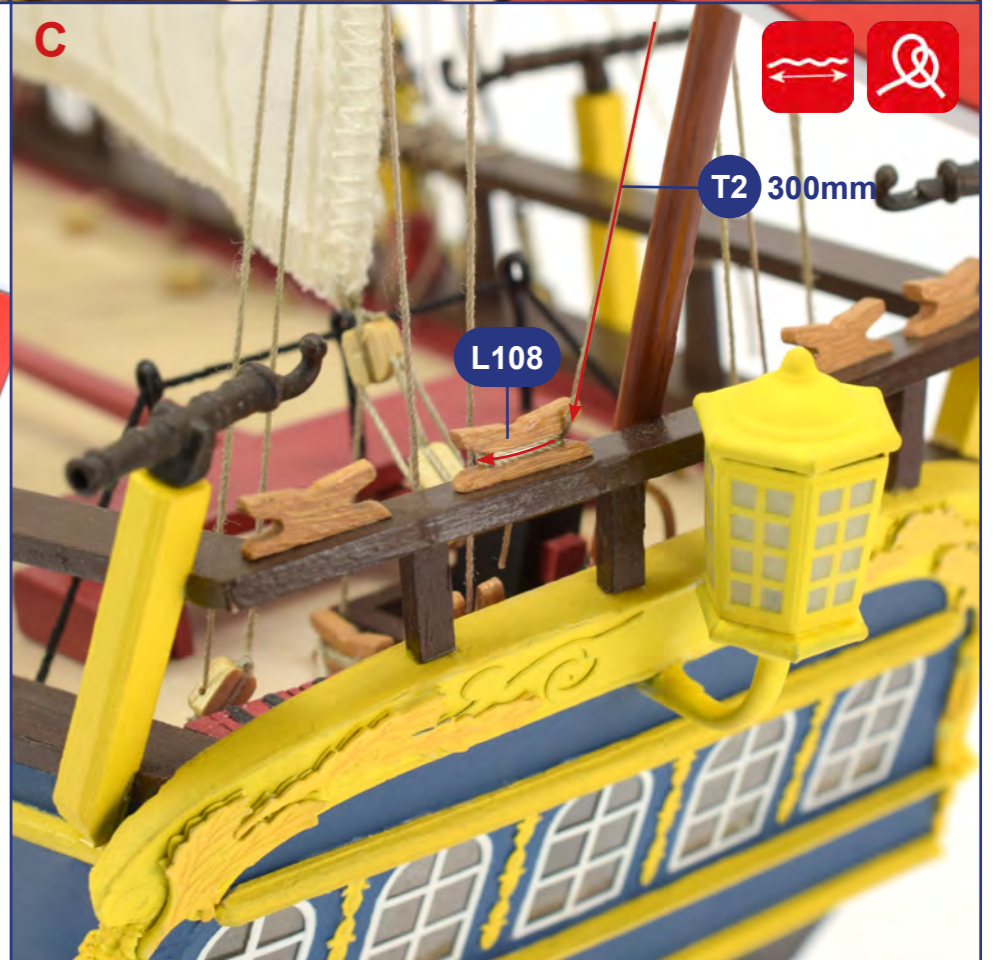
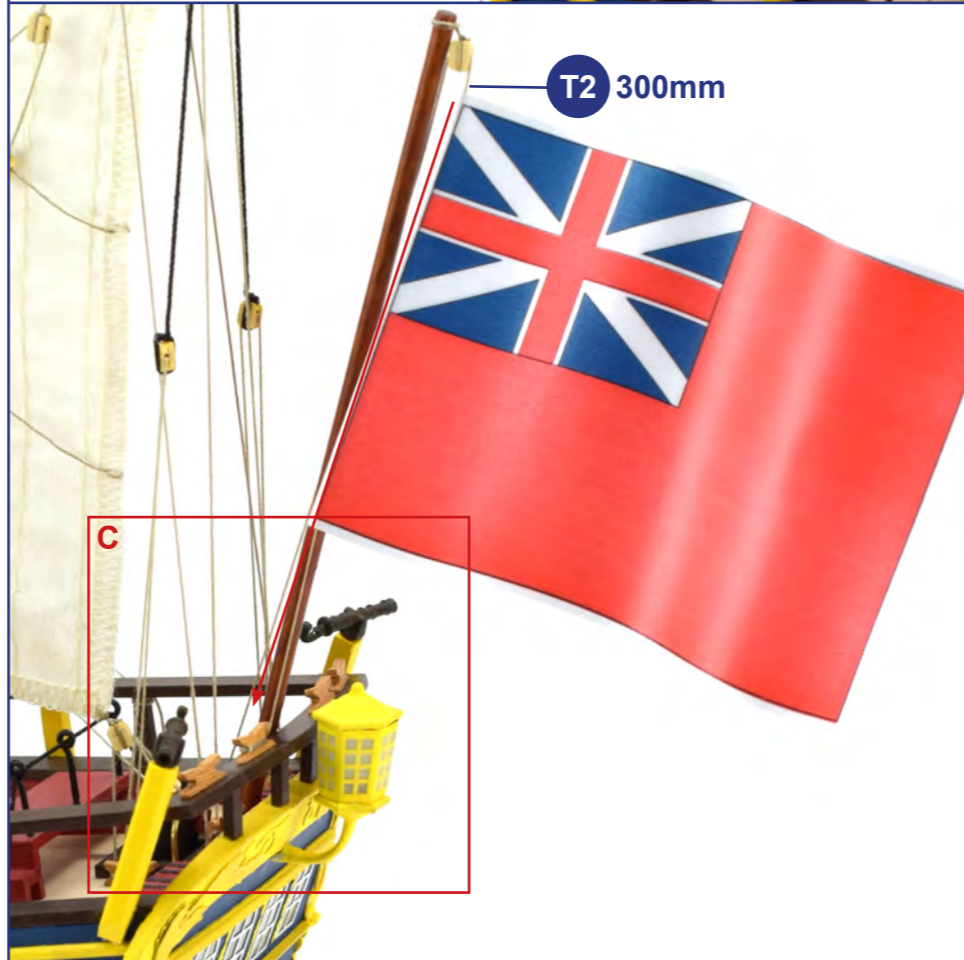
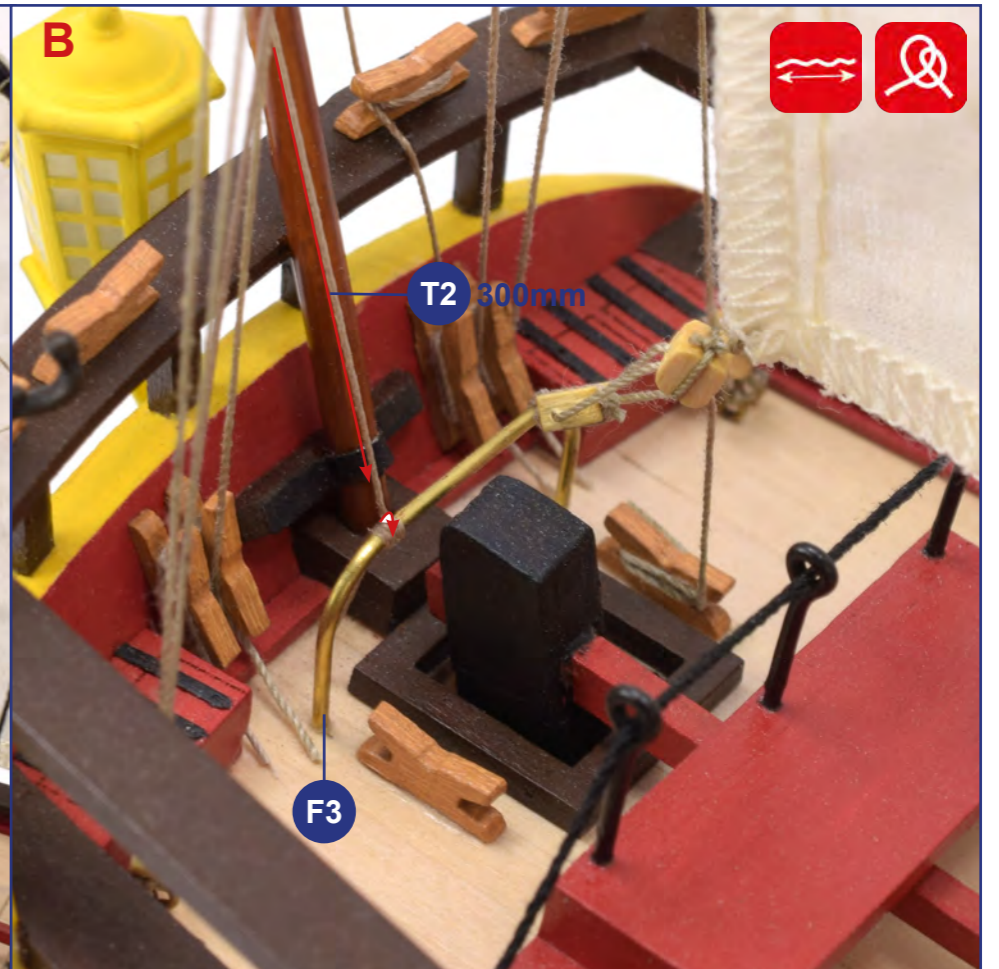

08



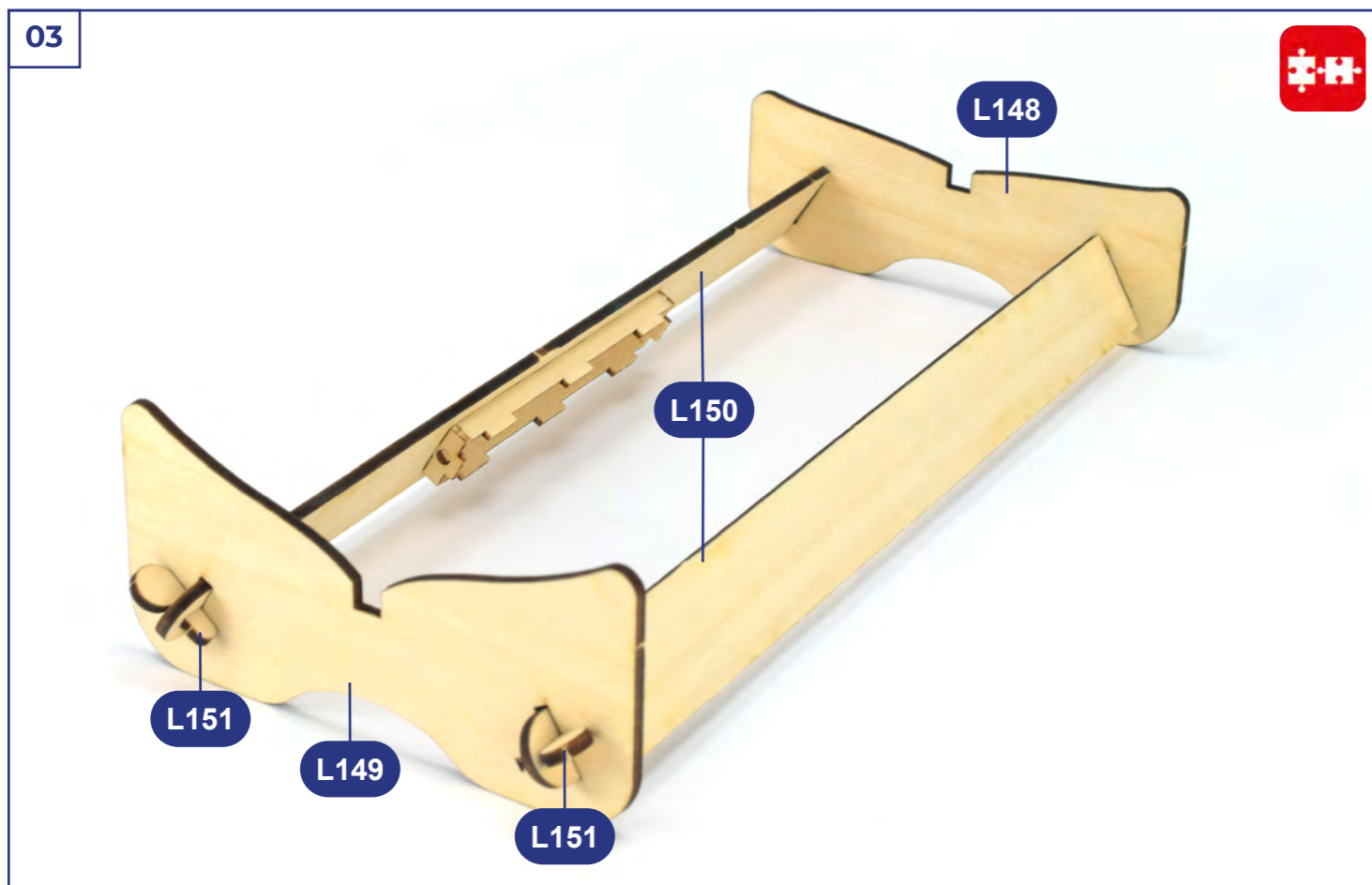
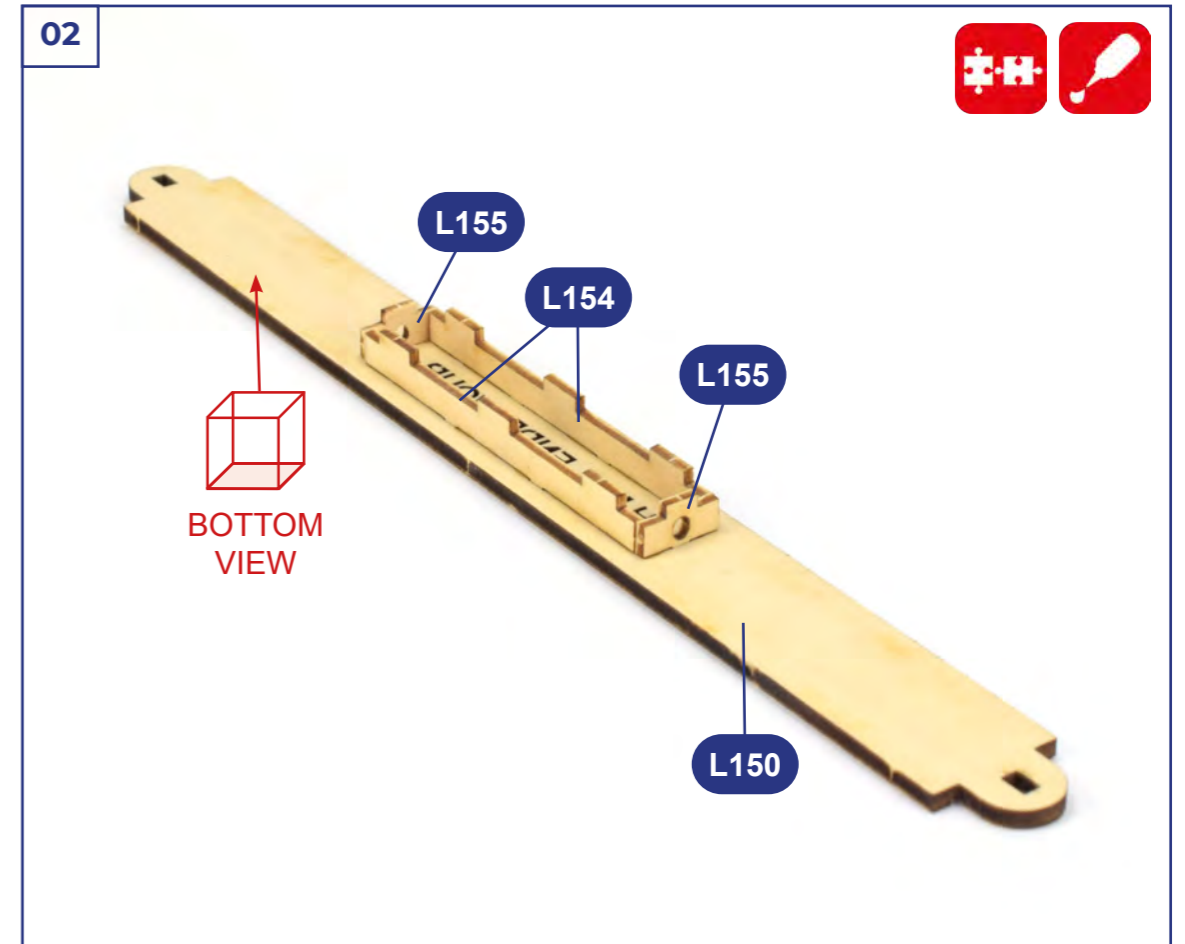
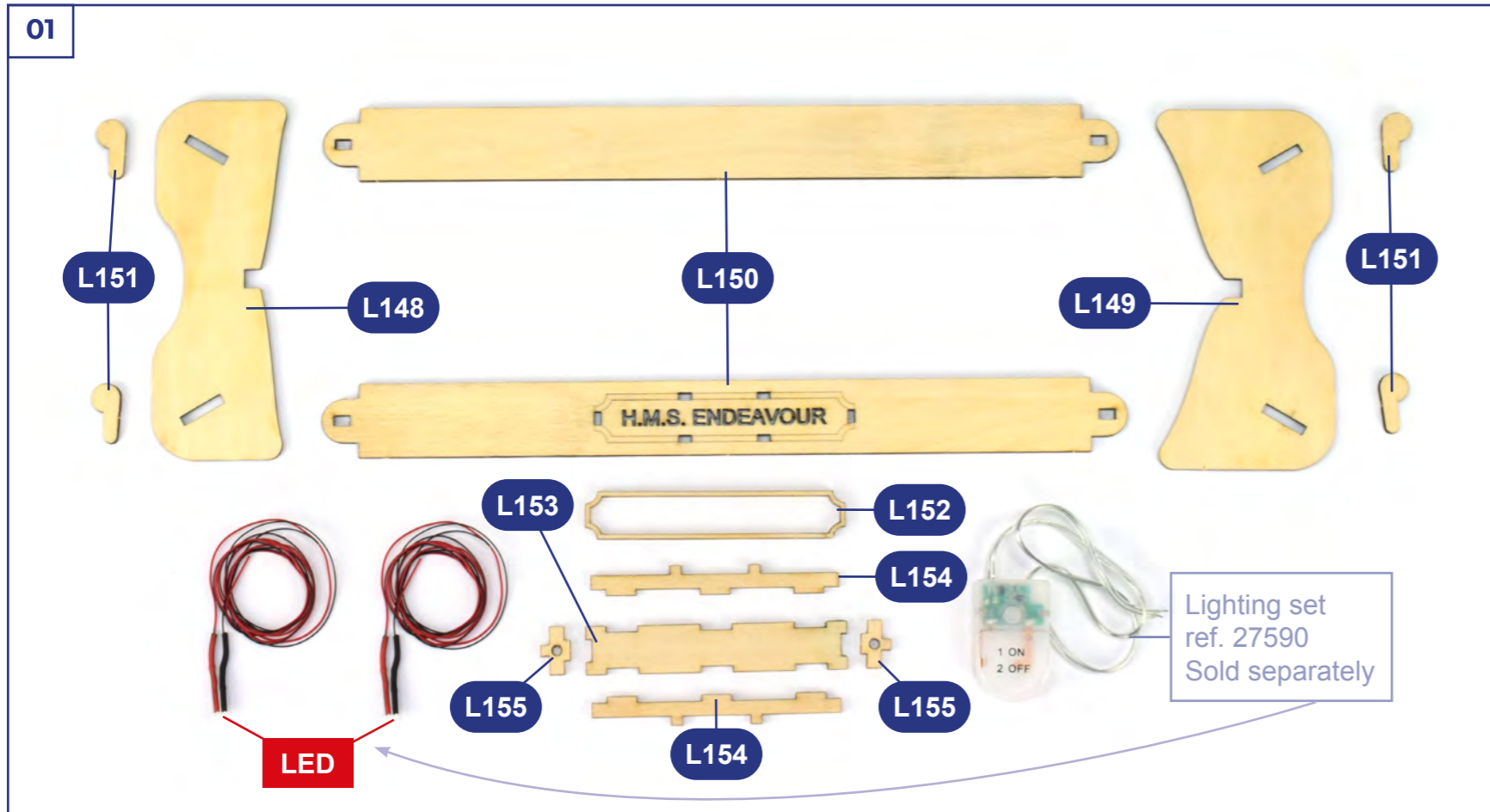

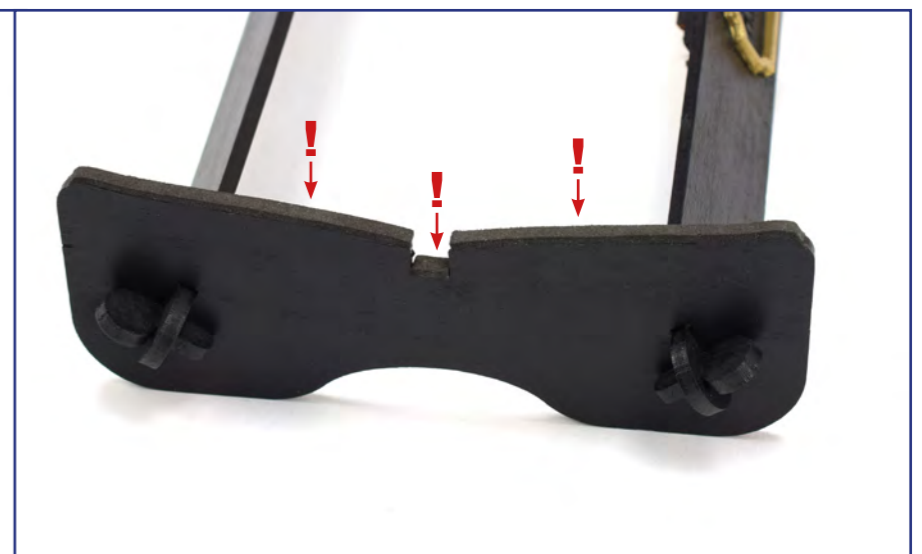
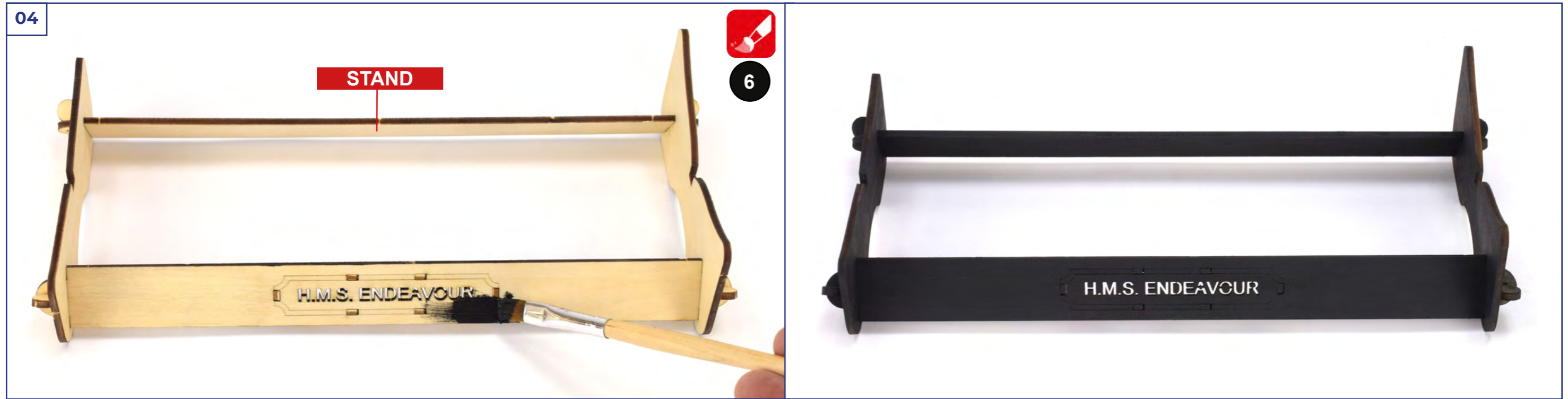

09

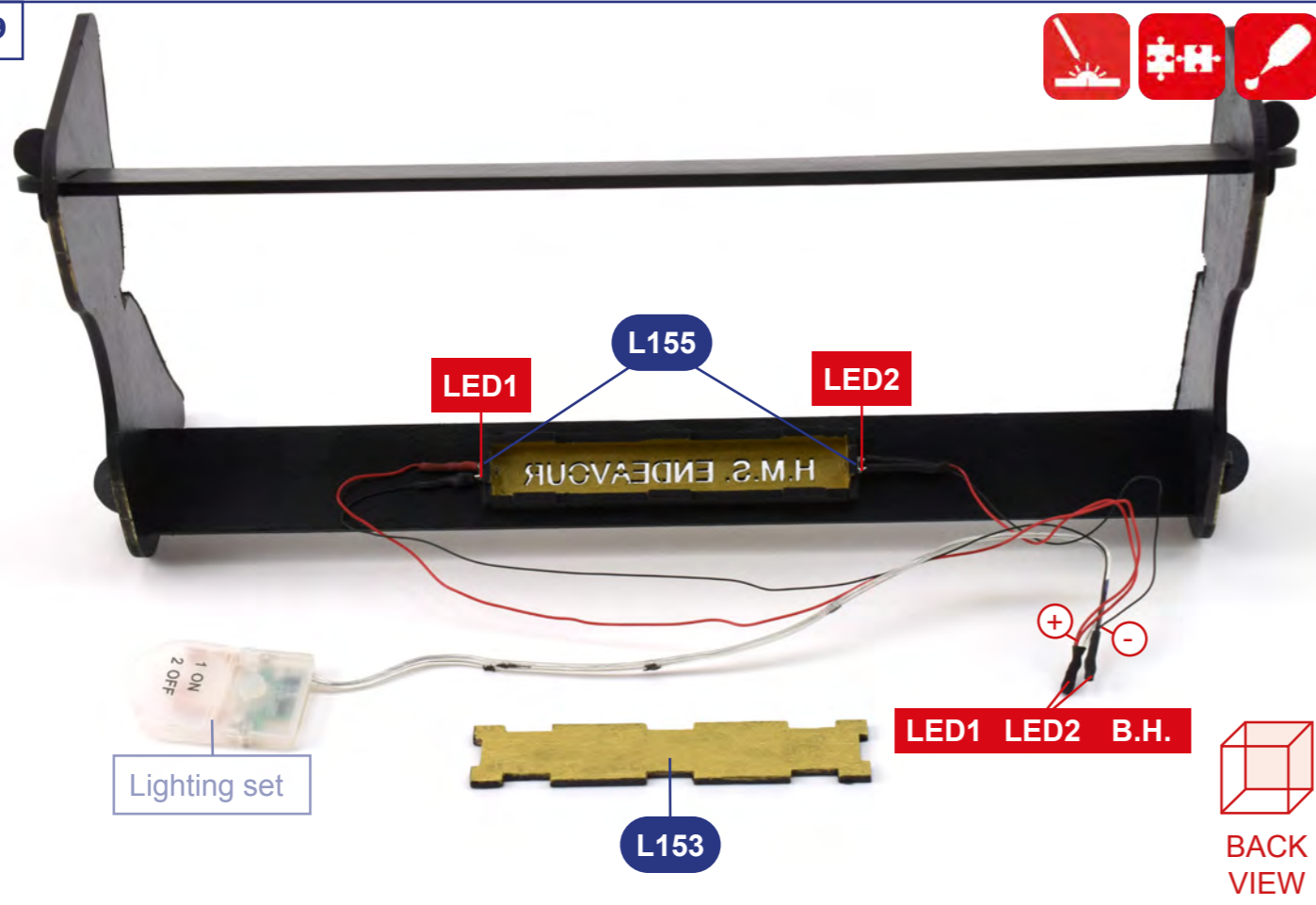

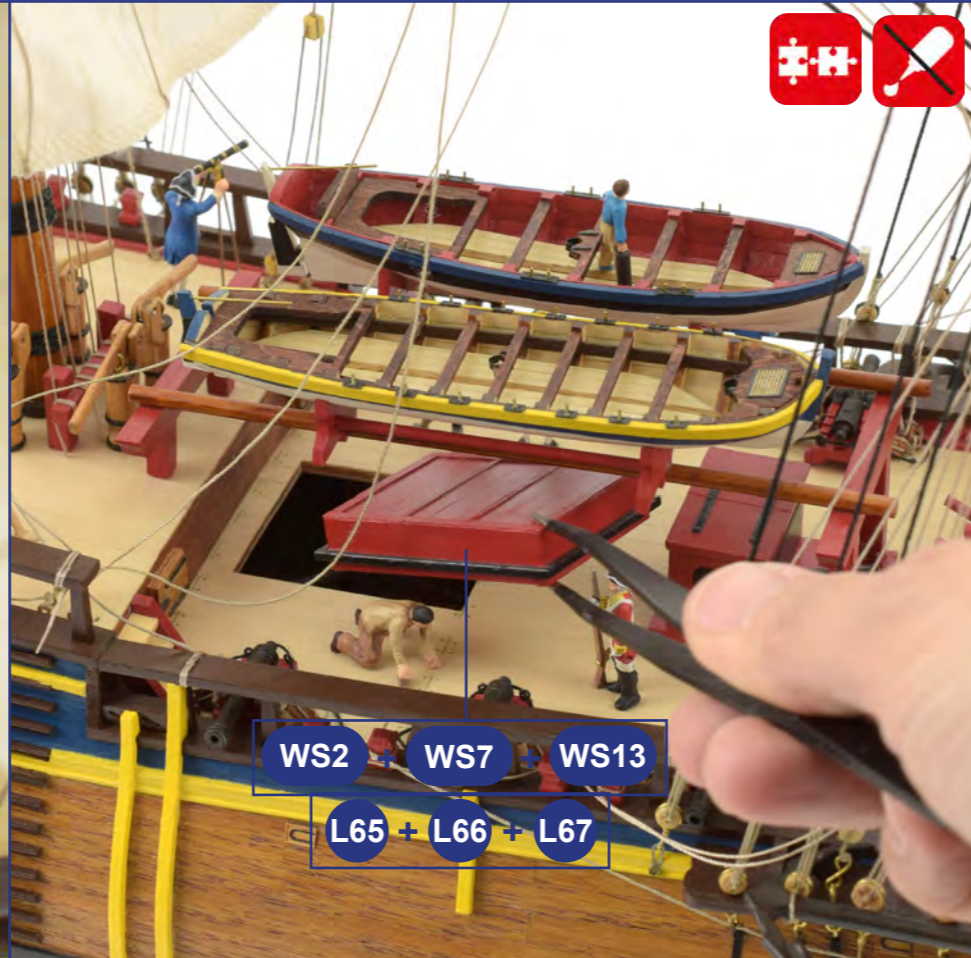
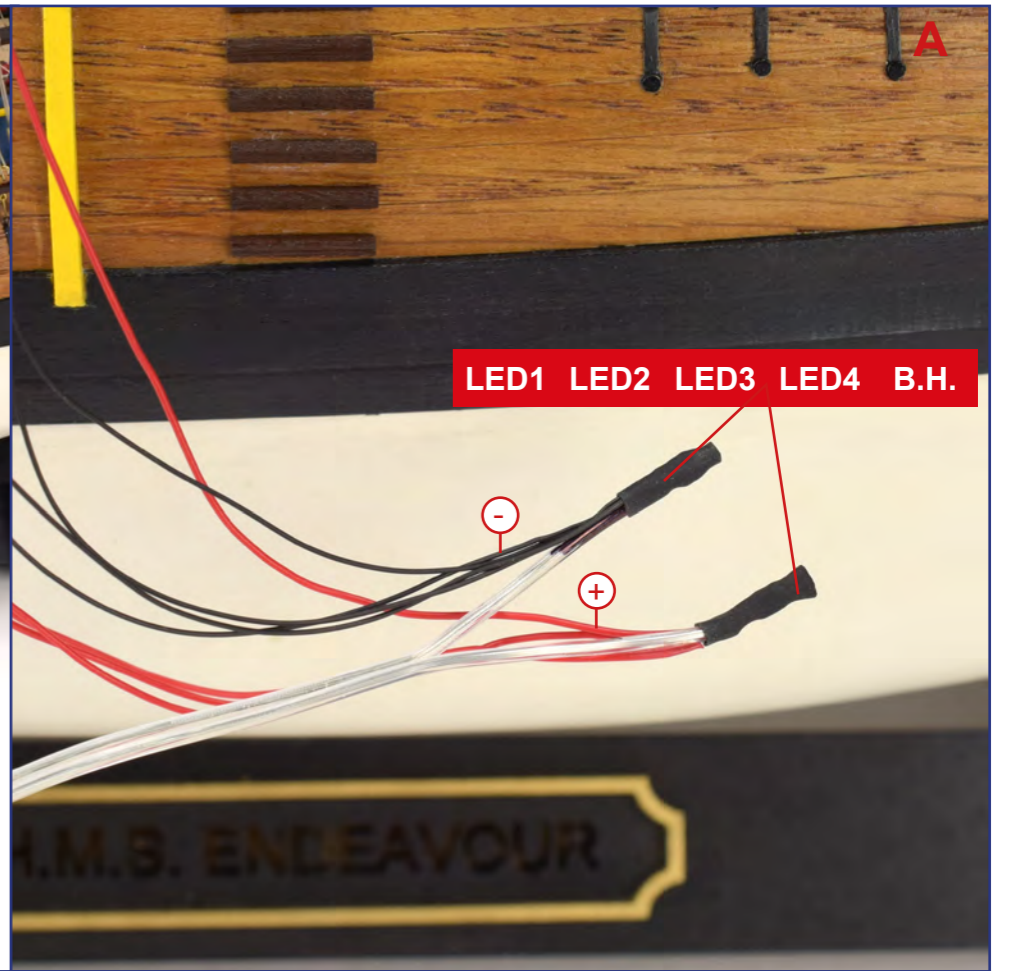
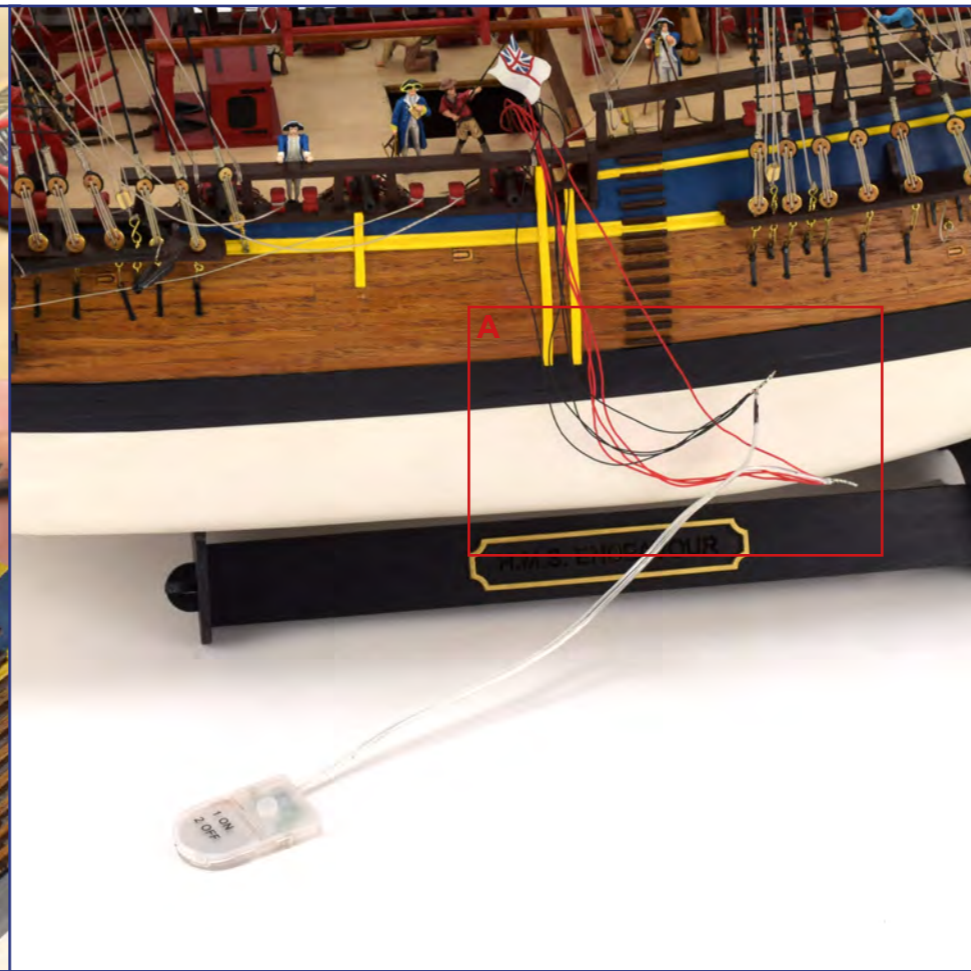
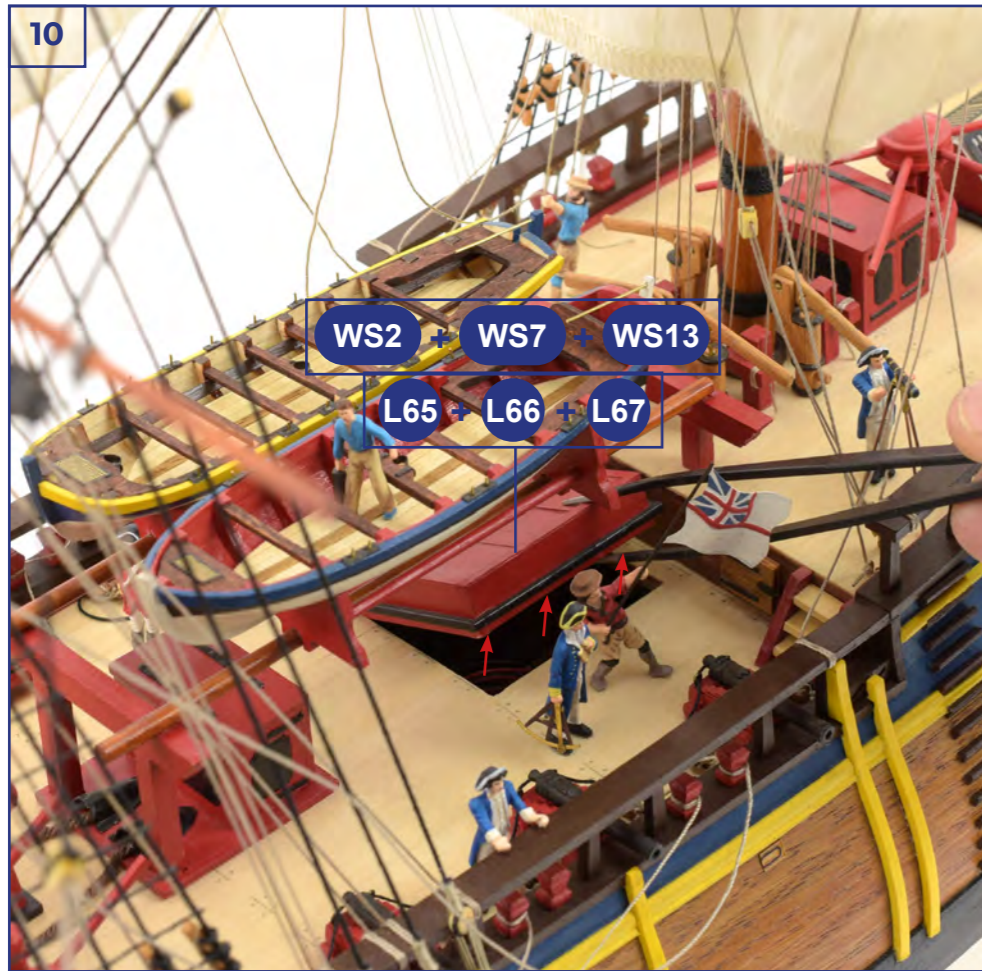

01



02





LE POUVOIR DE L'IMAGINATION
www.artesania latina.net